



Automation for a Changing World

Delta SCARA Robots



www.deltaww.com



DELTA
Smarter. Greener. Together.

Smart Robot for Upgraded Industries

Current trends affecting manufacturing industries include labor shortage, harsh environment, short commodity cycles, small-volume and large variety orders, and frequent changeovers. In response, production lines need more smart, agile and flexible workstations. For example, electronics manufacturing processes have to be executed fast and precisely to shorten time and enhance efficiency. Delta's Selective Compliance Assembly Robot Arm (SCARA) is your best choice to reduce labor cost and strengthen manufacturing flexibility.

Delta SCARA features sensor-less compliance control functions and offers excellent speed, linearity, verticality and repeatability to rapidly and precisely perform operation tasks such as insertion, assembly, screw locking, loading and unloading, pick-and-place, stacking and packaging. The automatic process path planning function fulfills industry needs for conveyor tracking processes such as glue dispensing, deburring, coating and soldering. With the aid of Delta's machine vision systems, it can perform smart identification, inspection and sorting to effectively reduce defect rates for consistent quality delivery.

When matched with control units and other peripheral devices such as servo systems, machine vision systems and linear modules, Delta SCARA becomes a highly integrated workstation for industries such as consumer electronics, electrical/electronics, rubber and plastics, packaging, metal fabrication and others. It satisfies both standalone and workstation applications, enabling flexible modularized production lines with consistently good quality to achieve smart and efficient production.

A new industrial revolution is moving towards smart manufacturing and factories. To meet customers' needs, Delta continues to provide innovative and efficient robot solutions as part of our "Automation for a Changing World".

- ▶ **Sensor-less compliance control**
- ▶ **High repeatability, excellent precision, linearity and verticality**
- ▶ **Widely applied in various applications and industries**



Table of Contents

- 1 Introduction
- 3 Specifications of SCARA Robots
- 7 External Dimensions and Workable Space
- 10 Product Features
- 12 Robotic Integration Software (DROE)
- 15 SCARA Robot Workstation Solution
- 16 External Dimensions of Robot Controller
- 17 Specifications of Robot Controller
- 18 Teaching Pendant DTS Series
External Dimensions
Specifications
- 20 Successful Applications

Successful Applications

Delta SCARA has been successfully applied to improve production line efficiency and yield rates for consistent quality delivery

Industries: Electrical/electronics, rubber and plastics, packaging, and metal fabrication

Applications: Insertion, screw locking, assembly, glue dispensing, coating, soldering, load and unload, pick-and-place, stacking, packaging, and inspection

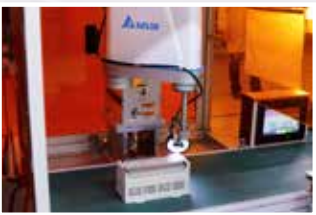

Product Inspection



Soldering

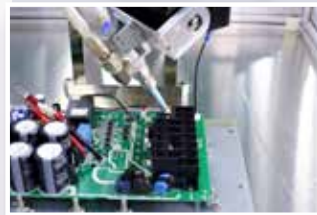

Glue Dispensing

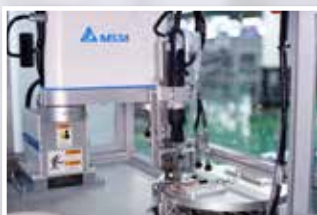

Screw Locking

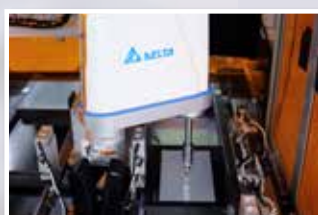

Touch Screen Inspection

Specifications SCARA Robots

DRS40L Series

Model		DRS40L3SS1BN002 DRS40L3SSADN003	DRS40L3SO1BN002
Number of Axes		4	
Installation		Table-top	
Arm Length (X + Y)		400 mm	
Rated / Max. Payload		1 kg / 3 kg	
Maximum Speed	J1 + J2	4710 mm / sec	
	J3	1250 mm / sec	
	J4	1875° / sec	625° / sec
Range of Motion	J1	±130°	
	J2	±146.6°	
	J3	150 mm	
	J4	±360°	
Standard Cycle Time *		0.42 sec	
Repeatability	J1 + J2	±0.01 mm	
	J3	±0.01 mm	
	J4	±0.01°	
Rated / Max. Push Force (J3)		100 / 250N	
Rated/ Max. Allowable Inertia Moment (J4)		0.0091 kg-m ²	0.055 kg-m ²
User Wiring		15 Pin D-Sub	
User Tubing		ø4 mm x 2, ø6 mm x 1	
Weight (Without Controller)		16 kg	
Environment	Ambient Temperature	5°C ~ 40°C	
	Storage Temperature	-25°C ~ 55°C	
	Humidity	0 ~ 90% RH (non-condensing)	

*When carrying a payload of 1kg and reciprocating 25mm in vertical and 300mm in horizontal directions under an operating temperature of 25°C and within a humidity of 45% ~ 65% RH (non-condensing).

Ordering Information

DRS40L Series

DRS	40	L	3	S	S	1	B	N	002
Company/ Product/ Robot Type	Arm Length	Level	Max. Payload	Z-Axis Stroke (Horizontal Stroke)	R-Axis Speed Reduction Ratio	Generation	Controller	Teach Pendant	Identification
D : DELTA R : Robot S : SCARA	40 : 400 mm	L : Lite	3 : 3 kg	S : 150 mm	S : Standard (1/16) O : Optional (1/48)	A : CE 1: 1st Generation	B : Servo drive (Cable length 3 m) K : Servo drive (Cable length 5 m) D: CE controller(Cable length 3m)	N : Non	002 : Standard 4 Axes 003 : CE model 4 Axes

DRS60L Series

Model		DRS60L6SN1BN302	DRS60L6SO1BN002	DRS60L6OS1BN002	DRS60L6SS1BN002/ DRS60L6SSADN003	DRS60L3SSS1BN502	DRS60L3SS1BN002
Number of Axes		3	4	4	4	5	4
Installation		Table-top					
Arm Length (X + Y)		600 mm					
Rated / Max. Payload		2 kg / 6 kg				1 kg / 3 kg	
Maximum Speed	J1 + J2	5000 mm / sec					4050 mm / sec
	J3	1100 mm / sec					1250 mm / sec
	J4	N.A.	600° / sec		2000° / sec		1875° / sec
	J5	N.A.				600° / sec	N.A.
Range of Motion	J1	±133°					±114°
	J2	±153°					±148°
	J3	200 mm		300 mm	200 mm		150 mm
	J4	N.A.	±360°				
	J5	N.A.				±360°	N.A.
Standard Cycle Time *		0.39 sec				0.45 sec	0.72 sec
Repeatability	J1 + J2	±0.015 mm					±0.015 mm
	J3	±0.01 mm					±0.01 mm
	J4	N.A.	±0.01°				±0.01°
	J5	N.A.				±0.01°	N.A.
Rated / Max. Push Force (J3)		150 N / 350N				N.A	100N / 250N
Rated/ Max. Allowable Inertia Moment (J4)		N.A.	0.07 kg-m ²	0.01 kg-m ²			0.009 kg-m ²
User Wiring		15 Pin D-Sub					
User Tubing		ø4 mm x 1, ø6 mm x 2					ø4 mm x 2, ø6 mm x 1
Weight (Without Controller)		20 kg				21 kg	22 kg
Environment	Ambient Temperature	5°C ~ 40°C					
	Storage Temperature	-25°C ~ 55°C					
	Humidity	0 ~ 90% RH (non-condensing)					

*When carrying a payload of 1 kg and reciprocating 25mm in vertical and 300mm in horizontal directions under an operating temperature of 25°C and within a humidity of 45% ~ 65% RH (non-condensing).

Ordering Information

DRS60L Series

DRS	60	L	6	S	S	1	B	N	002
Company/ Product/ Robot Type	Arm Length	Level	Max. Payload	Z-Axis Stroke (Horizontal Stroke)	R-Axis Speed Reduction Ratio	Generation	Controller	Teach Pendant	Identification
D : DELTA R : Robot S : SCARA	60 : 600 mm	L : Lite	6 : 6 kg 3 : 3 kg	S : 200 mm O : 300 mm	S : Standard (1/15) N : Non O : Optional (1/50)	A : CE 1: 1st Generation	B : Servo drive (Cable length 3 m) K : Servo drive (Cable length 5 m) D: CE controller(Cable length 3m)	N : Non	002 : Standard 4 Axes 302 : 3 Axes 502 : 5 Axes 003 : CE 4 Axes

Specifications SCARA Robots

DRS50 / 70L Series

Model		DRS50L6SS1BN002	DRS50L6SO1BN002	DRS50L6OS1BN002	DRS70LSS1BN002	DRS70L3SO1BN002	DRS70L3OS1BN002
Number of Axes		4					
Installation		Table-top					
Arm Length (X + Y)		500 mm			700 mm		
Rated / Max. Payload		2 kg / 6 kg					
Maximum Speed	J1 + J2	4400 mm / sec			5500 mm / sec		
	J3	1100 mm / sec					
	J4	2000° / sec	600° / sec	2000° / sec	2000° / sec	600° / sec	2000° / sec
Range of Motion	J1	±133°					
	J2	±153°					
	J3	200 mm	200 mm	300 mm	200 mm	200 mm	300 mm
	J4	±360°					
Standard Cycle Time *		0.39 sec			0.40 sec		
Repeatability	J1 + J2	±0.015 mm					
	J3	±0.01 mm					
	J4	±0.01°					
Rated / Max. Push Force (J3)		150 N / 350 N					
Rated/ Max. Allowable Inertia Moment (J4)		0.01 kg-m ²	0.07 kg-m ²	0.01 kg-m ²	0.01 kg-m ²	0.07 kg-m ²	0.01 kg-m ²
User Wiring		15 Pin D-Sub					
User Tubing		ø4 mm x 2, ø6 mm x 2					
Weight (Without Controller)		18.5 kg			20 kg		
Environment	Ambient Temperature	5°C ~ 40°C					
	Storage Temperature	-25°C ~ 55°C					
	Humidity	0 ~ 90% RH (non-condensing)					

*When carrying a payload of 1kg and reciprocating 25mm in vertical and 300mm in horizontal directions under an operating temperature of 25°C and within a humidity of 45% ~ 65% RH (non-condensing).

Ordering Information

DRS50 / 70L Series

Company/ Product/ Robot Type	Arm Length	Leve	Max. Payload	Z-Axis Stroke (Horizontal Stroke)	R-Axis Speed Reduction Ratio	Generation	Controller	Teach Pendant	Identification
D : DELTA R : Robot S : SCARA	50 : 500mm 70 : 700mm	L : Lite	6 : 6 kg	S : 200 mm O : 300 mm	S : Standard (1/15) O : Optional (1/50)	A : CE 1: 1st Generation	B : Servo drive (Cable length 3 m) K : Servo drive (Cable length 5 m)	N : Non	002 : Standard 4 Axes

DRS60H Series (To be launched)

Model		DRS60H6SS1BN002	
Number of Axes		4	
Installation		Ceiling mounted	
Arm Length (X + Y)		600 mm	
Rated / Max. Payload		2 kg / 6 kg	
Maximum Speed	J1 + J2	5000 mm / sec	
	J3	1100 mm / sec	
	J4	2000° / sec	
Range of Motion	J1	±130°	
	J2	±150°	
	J3	200 mm	
	J4	±360°	
Standard Cycle Time *		0.39 sec	
Repeatability	J1 + J2	±0.015 mm	
	J3	±0.01 mm	
	J4	±0.01°	
Rated / Max. Push Force (J3)		150 N / 350 N	
Rated/ Max. Allowable Inertia Moment (J4)		0.01 kg-m ²	
User Wiring		15 Pin D-Sub	
User Tubing		∅4 mm x 1, ∅6 mm x 2	
Weight (Without Controller)		23 kg	
Environment	Ambient Temperature	5°C ~ 40°C	
	Storage Temperature	-25°C ~ 55°C	
	Humidity	0 ~ 90% RH (non-condensing)	

*When carrying a payload of 1kg and reciprocating 25mm in vertical and 300mm in horizontal directions under an operating temperature of 25°C and within a humidity of 45% ~ 65% RH (non-condensing).

Ordering Information

DRS60H Series

DRS		60		H		6		S		S		1		B		N		002	
Company/ Product/ Robot Type	Arm Length	Leve	Max. Payload	Z-Axis Stroke (Horizontal Stroke)	R-Axis Speed Reduction Ratio	Generation	Controller		Teach Pendant	Identification									
D : DELTA R : Robot S : SCARA	60 : 600 mm	H : Hang	6 : 6 kg	S : 200 mm	S : Standard (1/15)	1	B : Servo drive (Cable length 3 m) K : Servo drive (Cable length 5m)		N : Non	002 : Standard 4 Axes									

DRS60L3 Series

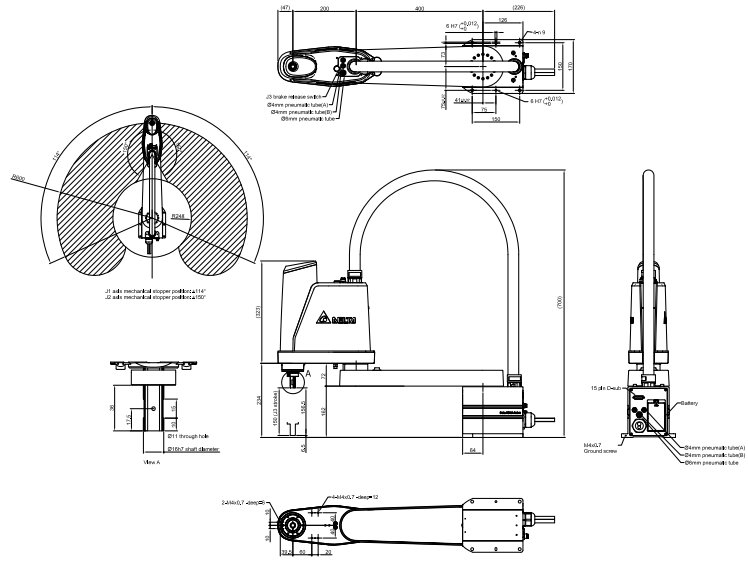

DRS60H Series

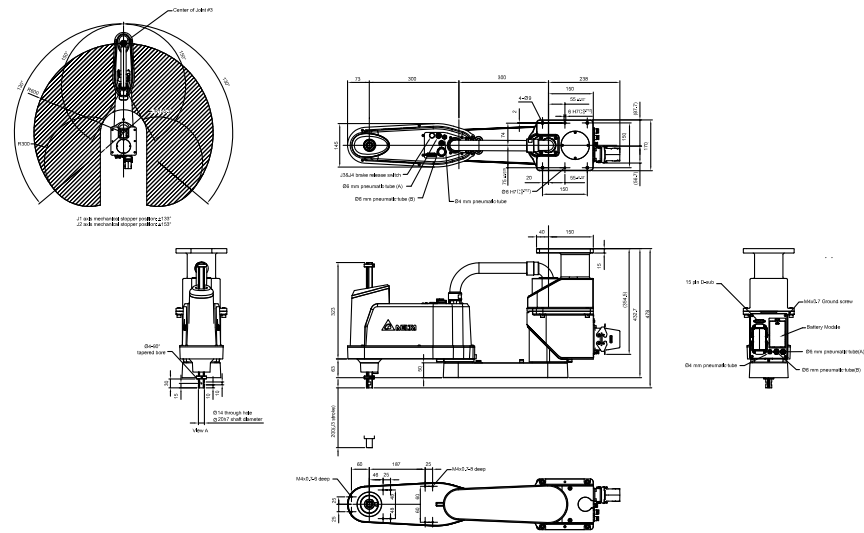

DRS60L3 5-axis series

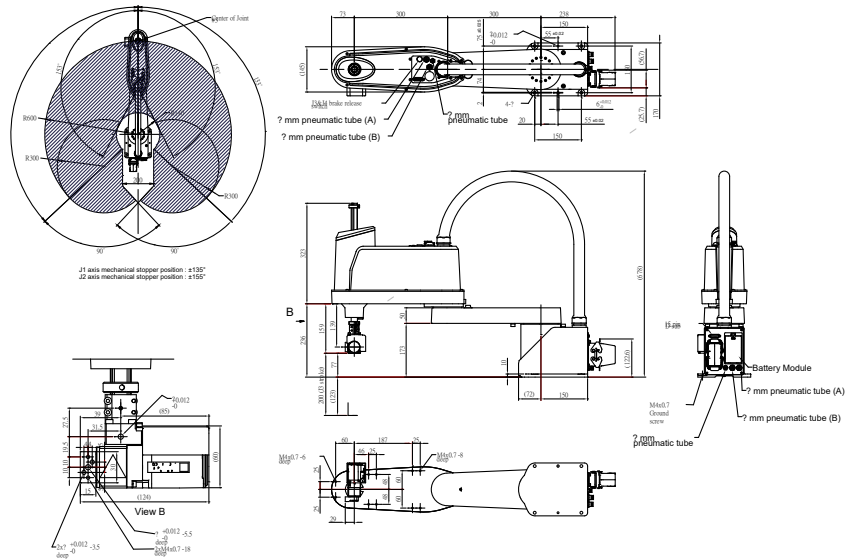

Product Features

High Repeatability, Excellent Precision, Linearity and Verticality



Product	Payload	Standard cycle time
DRS40L Series	1 kg	0.42 sec
DRS60L Series	1 kg	0.39 sec

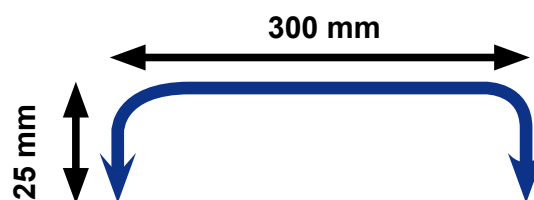

Product	DRS40L	DRS60L
Arm Length	400 mm	600 mm
Max. Payload (Payload)	3 kg	6 kg
Repeatability	±0.01 mm	±0.015 mm

Standard cycle time:

Time required for robot to move back and forth 300mm horizontally and 25mm vertically

Sensor-less Compliance Control Function

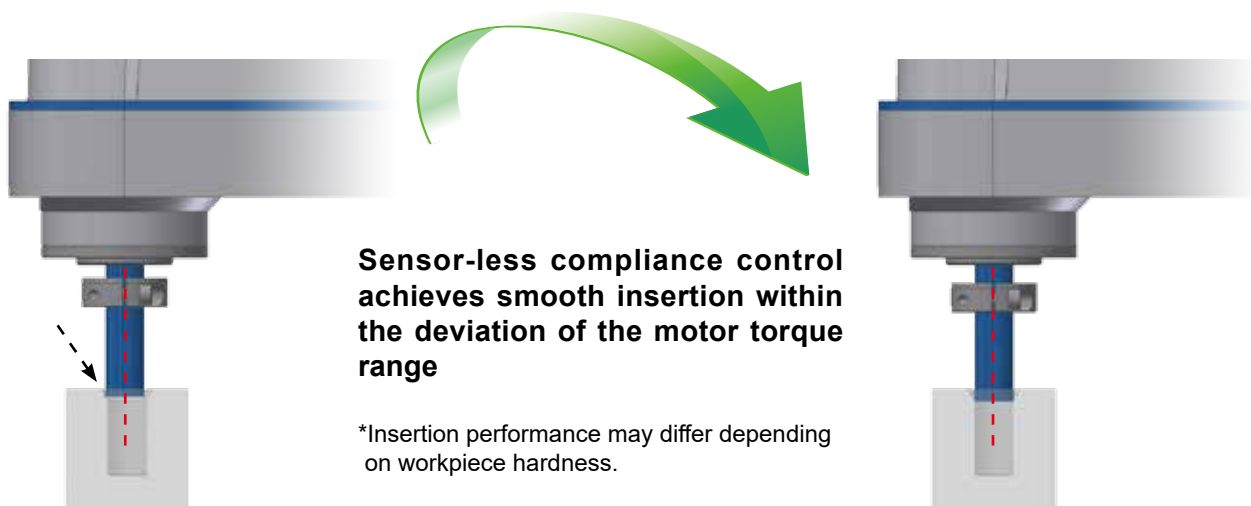

Sensor-less compliance control achieves smooth insertion within the deviation of the motor torque range

*Insertion performance may differ depending on workpiece hardness.

Simple and Easy Operation

► Multiple Teaching Methods



PAD



Teaching Pendant



PC



► User-friendly Robotic Integration Software

- Built-in standard testing modules for quick testing (E.g. I/O points and motors)
- Standard modular program design for easy robot motion programming, high maintainability and low maintenance cost
- Integrates customer's UI tools to ensure the uniqueness and completeness of individual robotics systems

Simulation Module



Programming Module



Built-in Testing Module



Customized UI Module



* UI = User Interface

► Direct Teaching (Lead by Hand)



Positions are directly taught and controlled by hand, and recorded by SCARA



Adopts Delta Machine Vision Systems
DMV2000 / DMV1000

Robotic Integration Software

DRAStudio Features

- Easy programming for various applications
- Creates an offline simulation environment for robots
- Supports articulated robots operation



Friendly Programming Environment

- Quick and easy graphical programming
- Simplified programming languages and shorter commands to fulfill quick operation
- Integrates data and signals of peripheral devices to configure user-defined interface

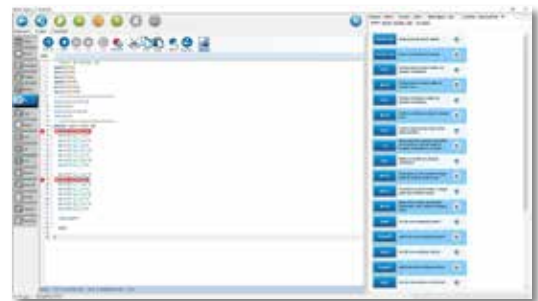

Various Robot Motion Commands and Parameter Setting Environment

- Motion commands : MovJ, MovP, MovL, MovPR, MovLR, MArc, Mcircle, Lift
- Motion parameters : SpdJ, AccJ, DecJ, SpdL, AccL, DecL, Accur

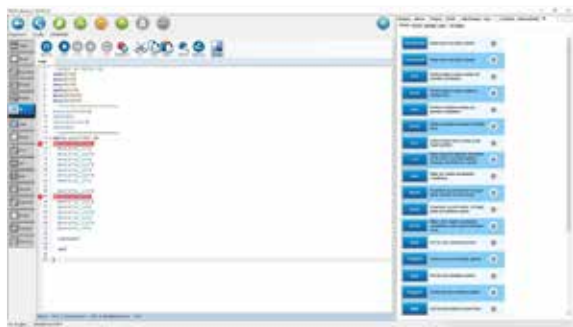

Process Control Environment Setting

- Process control commands : if...then...end, while...do...end, fordo...end, function, repeat

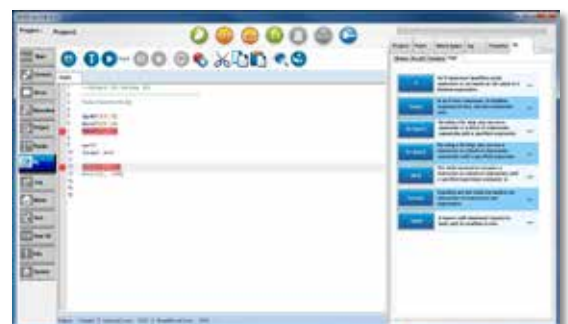

Coordinate System Environment Setting

- Coordinate commands : SetUF, ChangeUF, SetTF, ChangeTF
- Positioning commands : SetGlobalPoint, CopyPoint, ReadPoint, WritePoint, RobotX, RobotY, RobotZ, RobotRz, RobotHand

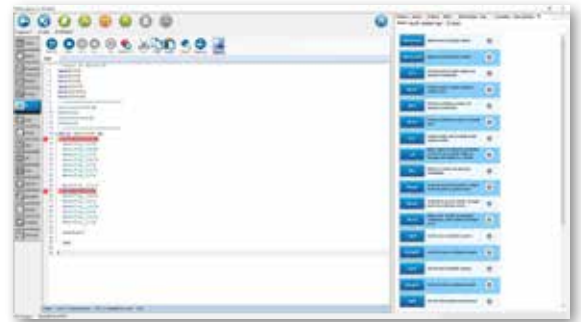

Digital I/O Control Setting

- Provides digital I/O control commands and monitoring

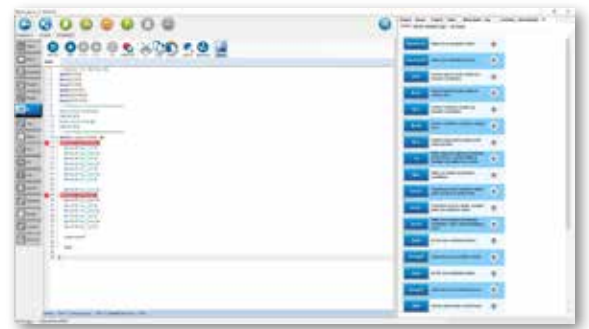
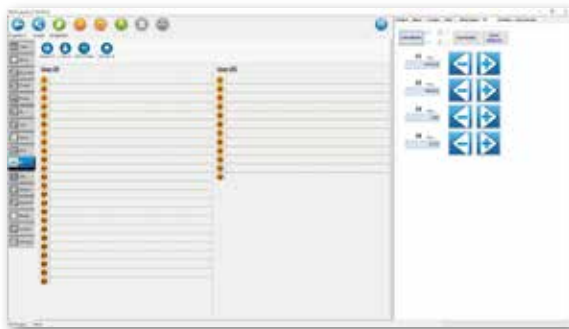

Coordinate System and Movement Recording Function

- Provides coordinate system (Joint / Tool / User / World) to teach robots movements
- Records real-time robot teaching movement for positioning verification

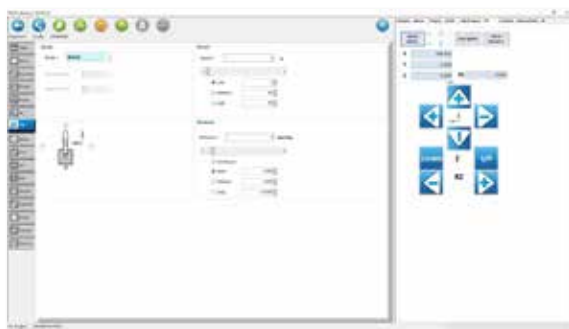

Workable Space Setting

- Up to 10 sets of 3D cylinder and rectangle shape workable space
- Limit robotic movement for safety



Robotic Integration Software

Tool Setting and User Interface

- Simple parameter setting
- Various user interface settings for easy integration



Fast Payload Adjustment and Information Transmission

- Quick payload setting to optimize robot systems
- Real-time monitoring information exchange between robot and peripheral devices for system efficiency

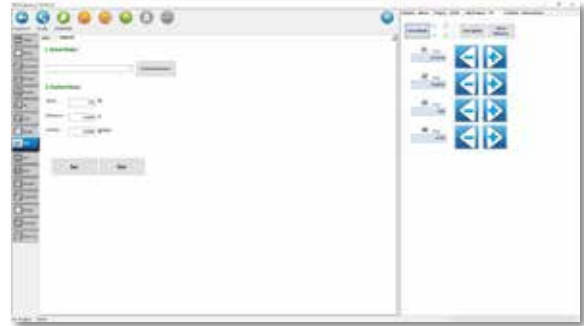
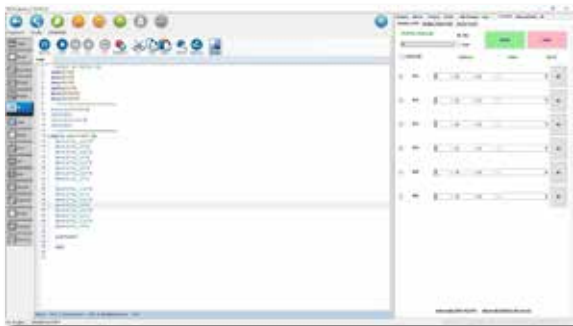

Sample Code and Templates for System Integration

- Adopt templates including vision sample code for customized applications

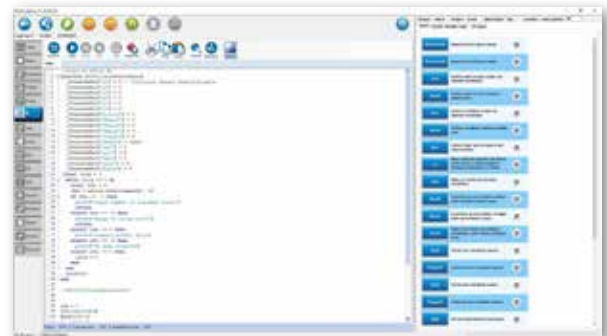

SCARA Robot Workstation Solution

- ▶ The highly flexible robotic workstation integrates control units and other peripheral devices
- ▶ Easy integration with machine vision systems achieves smart identification, inspection and automatic adjustment for consistent quality delivery

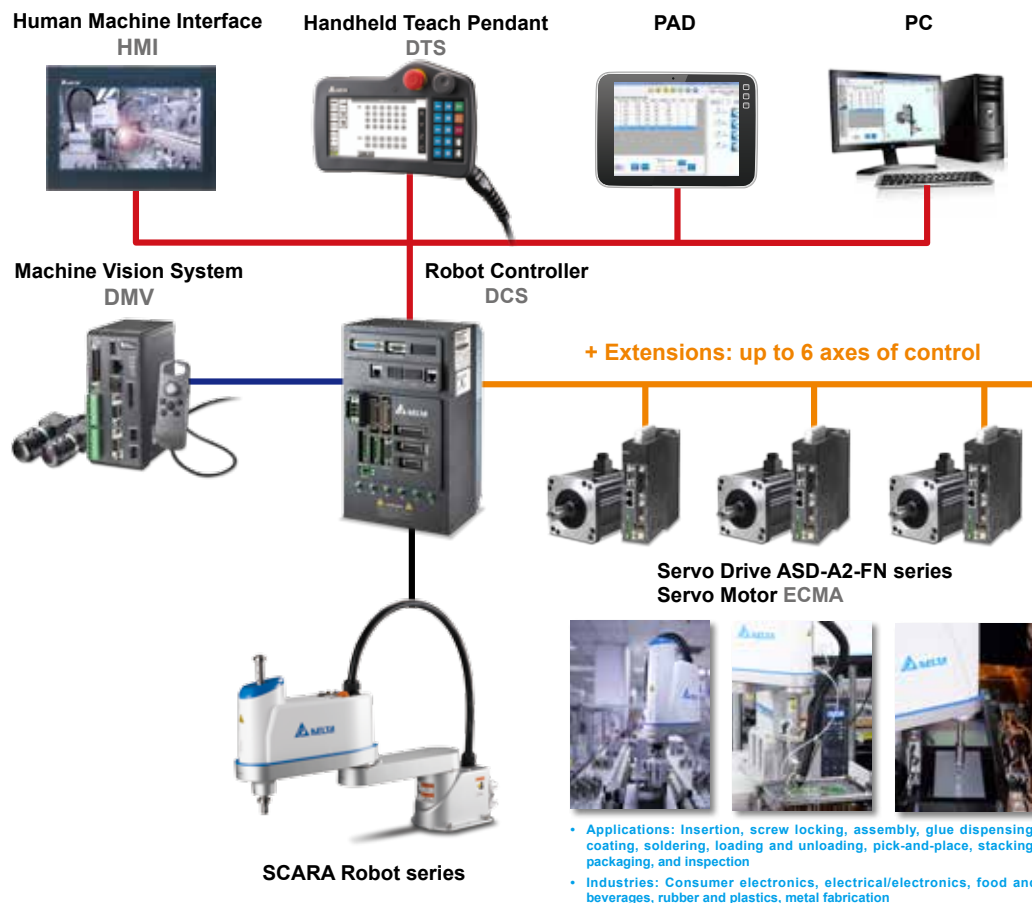

Ordering Information

Type	Model	Specification	Description
Robot Control Cable	DWSEP1003	3m robot control cable	Included (Various lengths available for different applications)
	DWSEP1005	5m robot control cable	
	DWSEP1010	10m control cable	
Peripheral Devices	3534518800	Optional system digital I/O (SYS.DIO) module, 1m cable included	Recommended for extended DI/O module connection
	3534518900	Optional standard digital I/O (SYS.DIO) module, 1m cable included	
	3081422700	Optional 1 m connection cable for system digital I/O (SYS.DIO) No soldering required, number mark on the other side	
	3081734900	1m CANopen connection cable	
	3864267000	3m CANopen connection cable	
	3864999300	10m CANopen connection cable	
	ASD-DMC-RM32MN	Remote 32 points DI	Recommended for extended drive connection
	ASD-DMC-RM64MN	Remote 64 points DI	
	ASD-DMC-RM32NT	Remote 32 points DO	
	ASD-DMC-RM64NT	Remote 64 points DO	
	ASD-A2-0121-FN	100W drive	
	ASD-A2-0221-FN	200W drive	
ASD-A2-0421-FN	400W drive		

Exterior of the Robot Controller

Teach Pendant Connection Port

High-speed Communication and Software Port

- Ethernet: connects PCs or notebooks, capable of accessing data through DROE software
- USB1, USB2: Directly connects to USB flash drives
- DMCNET: Connects DMCNET peripherals

Main Circuit Terminal (RS)

Connects 200-230Vac, 50/60Hz commercial power supply

Brake Control Digital Output Terminal (BRK.DIO)

STO I/O Terminal (Safe Torque Off)

Connects a certified safety relay or switch for controlling STO I/O signals

Control Power Input

Connects DC24V power supply

System I/O Terminal (SYS. DIO)

Serial Communication Port

For Modbus communication control, supporting RS-485 / RS-232 serial communication

LED Display

The 5 digit, 7 segment LED displays the controller status or fault codes

Servo Motor Output (U, V, W)

Connects servo motors. Never connect the output terminal to main circuit power as the drive may be damaged beyond repair if incorrect cables are connected to the output terminals

Standard I/O Terminal (STD. DIO)

Full-closed Loop Control Interface (EXT. ENG)

Feeds back the position signals of the full closed linear scale and encoder for controlling A, B, Z phase signals

Motor Encoder Interface (MOTOR. ENC.)

The encoder signals of four servo motors

Ground Terminal

Grounding wire of power supply and servo motor



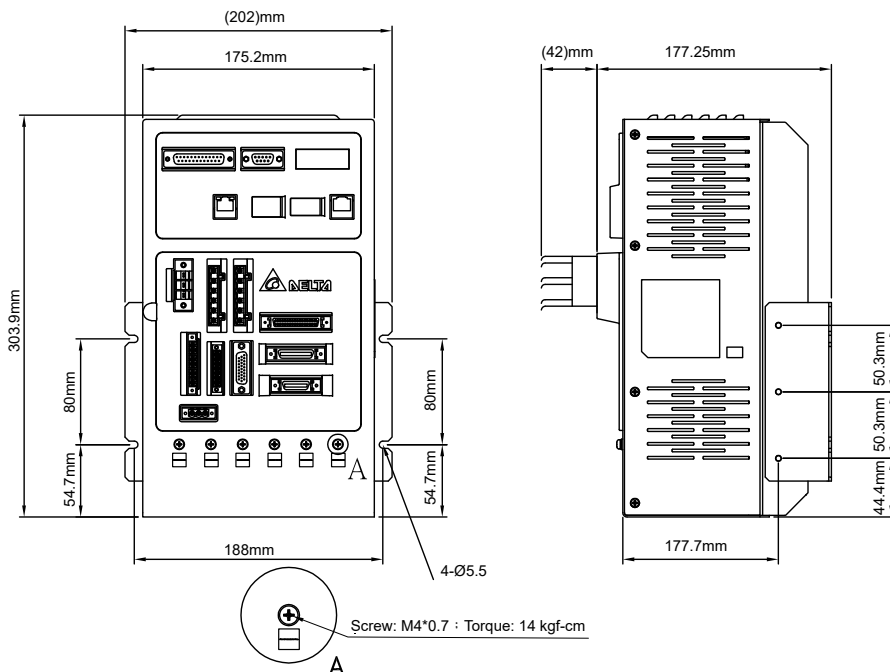

Dimensions of the Robot Controller



NOTE

- 1) Dimensions are in millimeters (inches); Weights are in kilograms (kg) and pounds (lbs)
- 2) Dimensions and weights of the robot controller may be revised without prior notice

Specifications of the Robot Controller

DCS Series		
Power Supply	Phase / Voltage	Single phase: 200-230Vac, 5A
	Control Power Supply	22-24Vdc, 5A
Dimensions (W) X (H) X (D) mm / Weight		175 mm x 300 mm x 159 mm / 5.6 kg
Cooling Method		Fan cooling
External Optical Scale or Encoder		A, B, and Z format
Robot Control	Programming Language	Delta robot language
	Motion Mode	Point-to-point motion, linear interpolation, circular interpolation
	Memory Capacity	20MB: for program editing and data 16KB: for PLC SV/DV variables (without power failure detection) 60KB: for PLC DH variables (with power failure detection) 1K location point for universal variables (shared among different programs) Up to 32K location point for programming
Input / Output	Standard I/O	User I/O: 24 sets of inputs and 12 sets of outputs System I/O: 8 sets of outputs and 8 sets of inputs
Communication Interface	Ethernet	One channel
	RS-232 / RS-485	One connecting port (allows switching between two communication protocols)
	DMCNET	One channel
	USB Host	Two connecting ports
Environment	Installation	Indoor (avoid direct sunlight), no corrosive liquid and gas (avoid oil mist, flammable gas, dust)
	Altitude	Altitude 1000m or lower above sea level
	Atmospheric Pressure	86kPa ~ 106kPa
	Ambient Temperature	0C ~ 55°C (If ambient temperature is above 45°C, cooling is required)
	Storage Temperature	-20°C ~ 65°C
	Humidity	0 ~ 90% RH (non-condensing)
	Vibration	9.80665m/s ² (1G) less than 20Hz, 5.88m/s ² (0.6G) 20 to 50Hz
	IP Rating	IP20
	Power System	TN system ^{*1}
Safety Certifications	IEC/EN 61800-5-1, UL 508C, RCM   	

*1 TN system: A power distribution system having one point directly earthed, the exposed conductive parts of the installation being connected to that points by a protective earth conductor.

Handheld Teach Pendant DTS



Dimensions

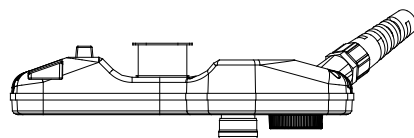

Weight: 720g (without cable)

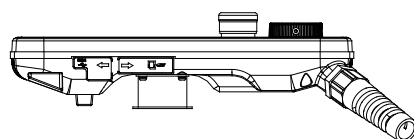
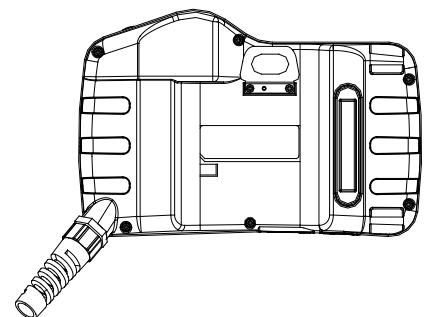
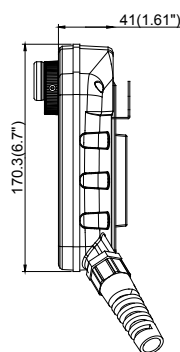
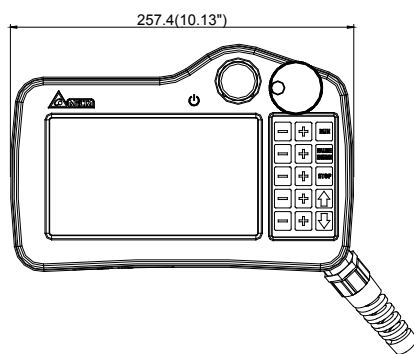
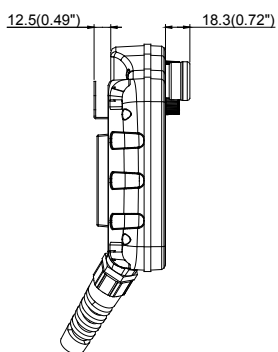

NOTE

- 1) Dimensions are in millimeters (inches);
Weights are in kilograms (kg) and pounds (lbs)
- 2) Dimensions and weights of the teaching pendant may be revised without prior notice

Specifications of the Handheld Teach Pendant

Model	DTS-1FD	DTS-1GD	DTS-2FM	DTS-2GM
LCD Module	Display Type : 7" Widescreen TFT LCD Resolution (pixels) : 800 x 480 Backlight Luminance (cd/m2) : 450		Colors : 65536 Backlight : LED Back Light Backlight Lifetime (Hr) ¹⁾ : 20,000	
Arithmetic-Logic Unit (ALU)	CPU : 400 MHz RAM (Bytes) : 64MB		Flash ROM (Bytes) : 128MB Backup Memory (Bytes) : 16MB	
Buzzer	Multi-tone Frequency (2K ~ 4K Hz) / 80dB			
Connector	Connector: D-Sub (25 pin)		Military (17 pin)	
Real Keys	15 keys		21 keys	
USB	1 USB Client Ver 2.0			
SD	SD card (support SDHC)			
Ethernet	1 Port ²⁾			
Function Key	15			
Cable Length	5 m	10 m	5 m	10 m
Emergency Stop Switch	IEC60947-5-1, EN60947-5-1, IEC60947-5-5, EN60947-5-5, UL 508, CSA C22.2 No.14, GB 14085.5			
3-Position Operation Switch	EN/IEC60947-5-8, IEC60947-5-1, EN60947-5-1, JIS C8201-5-1, UL508, CSA C22.2 NO. 14 ISO12100-1, -2/EN12100-1, -2, IEC60204-1/EN60204-1, ISO11161/prEN11161, ISO10218/EN775, ANSI/RIA R15.06, ANSI B11.19			
Safety Standard	CE			
Protection Rating	IP55			
Voltage Endurance ^{*3}	22-28Vdc			
Waterproof Degree	24Vdc terminal and FG terminal: 500Vac, 1min Power Consumption			
Power Consumption ^{*5}	5.6W			
Backup Battery	3V lithium CR2450 x 1			
Backup Battery Life	5 years or more at 25°C, may vary due to temperature and usage condition			
Operation Temperature	0°C ~ 40°C			
Storage Temperature	-20°C ~ +60°C, 10% ~ 90% RH			
Operation Environment	10% ~ 90% RH (0 ~ 40°C), 10% ~ 55% RH (41 ~ 50°C), pollution degree 2			
Vibration Resistance	Conforms to IEC61131-2, 5Hz~8.3Hz 3.5mm, 8.3Hz~150Hz 1G			
Shock Resistance	Conforms to IEC60068-2-27, 11ms, 15G Peak , X, Y, Z direction for 6 times			
Dimensions W x H x D (mm)	257.4 x 170.3 x 71.8 (Emergency stop button and hook included)			
Weight	750g (Wire excluded)			

Note: 1) The half-life of the backlight is defined as the original luminance being reduced by 50% when the maximum driving current is supplied to the HMI.

2) Built-in isolated power circuit

3) Adopting isolated power supplies is suggested

4) The value of the power consumption indicates the electrical power consumed by HMI with no peripheral devices connected. To ensure normal operation, it is recommended using a power supply with a capacity 1.5~2 times the value of the power consumption.

Ordering Information

DTS Series

DT	S	1	F	D
Company/ Product	Category	Generation	Cable Length	Connector specification
D : Delta T : Teach Pendant	S : SCARA	1 : Generation 1 (15 Key)	F : Cable length 5m	D : D-Sub
		2 : Generation 2 (21 Key)	G = Cable length 10m	M : CE military model

Successful Applications

Conveyor Tracking and Glue Dispensing Solution

- SCARA provides fixture-less conveyor tracking
- Synchronizes the robot and motion of the conveyor without stopping it to enhance production efficiency

- The PC-Software consists of secondary development platform for easy and flexible customization
- General communication interface easily connects different machine vision systems and modules
- Simple system structure for easy configuration
- The solution adopts Delta industrial automation products for easy integration and maintenance

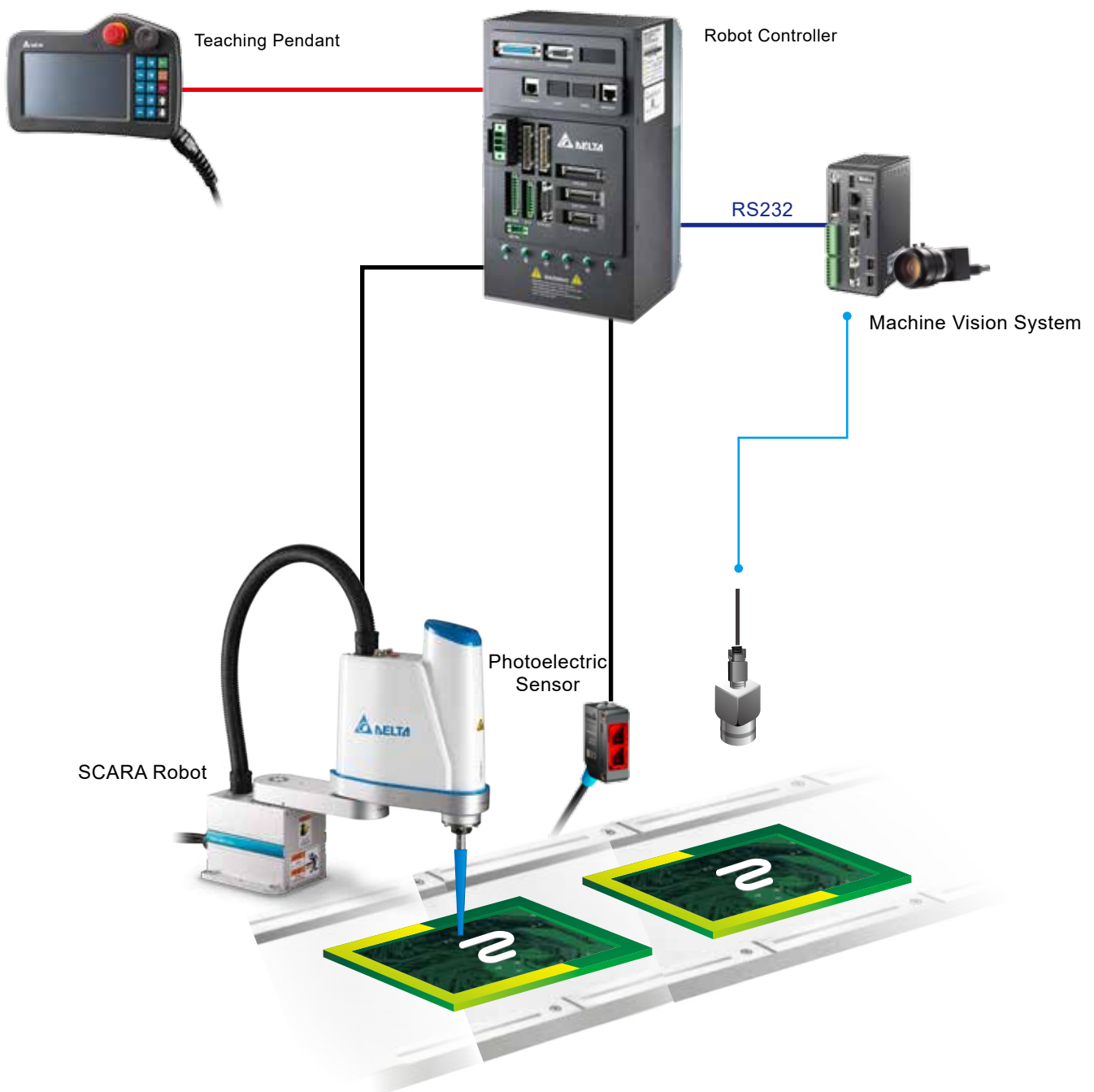

Successful Applications

Five-sided Product Inspection Solution

- Robot controller with servo drive integrated saves spaces and wiring
- Matches with machine vision system for flexible robot movement and easy interchangeable product inspection
- Adopts one communication protocol and simple wiring configuration with high reliability
- Links to MES System for optimized manufacturing and interchangeable production
- The solution adopts Delta industrial automation products for easy integration and maintenance

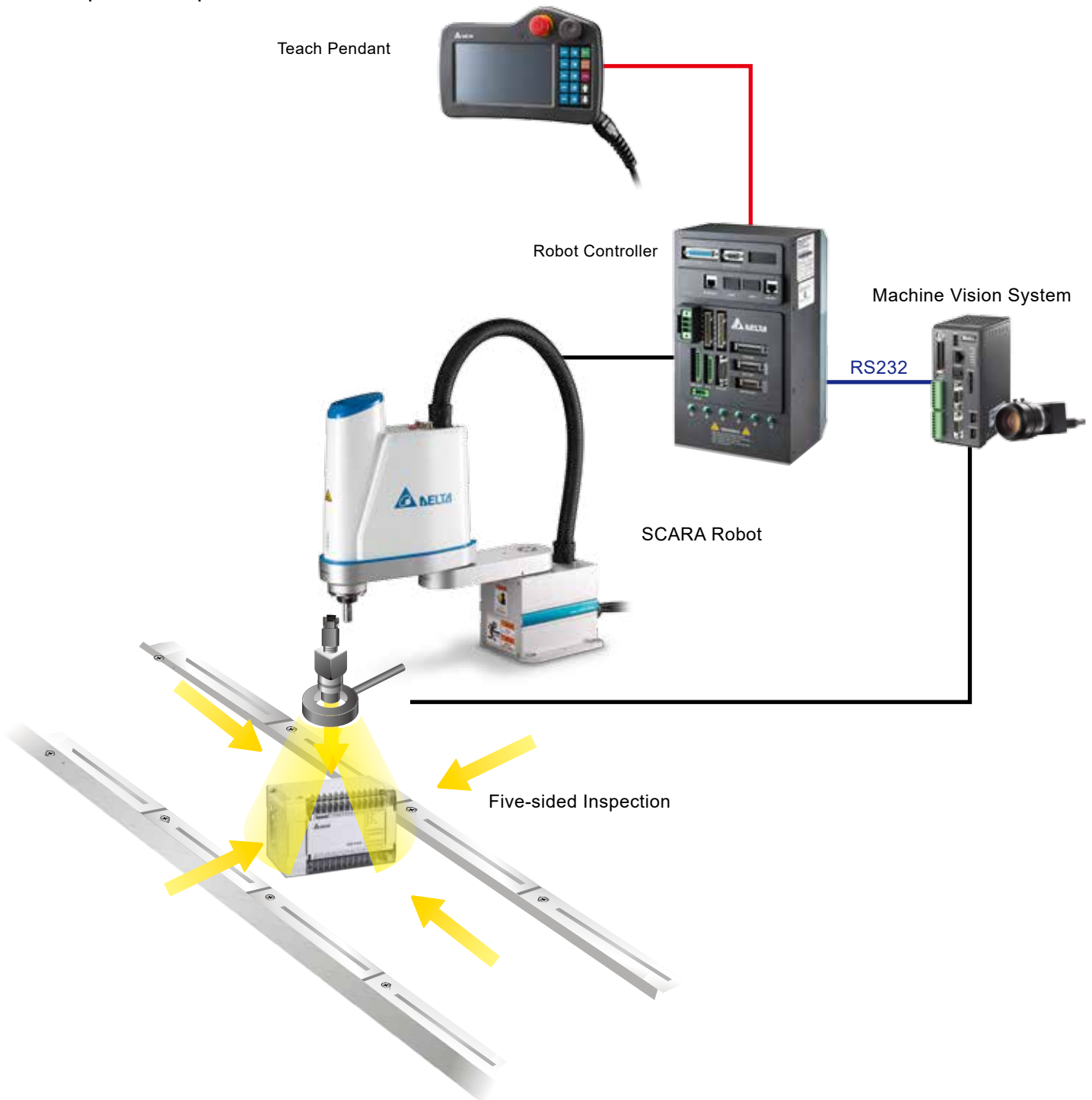

Successful Applications

Robotic Soldering Solutions

- Robot controller with servo drive integrated saves spaces and wiring
- Use soldering software to transform positions of solder holes in CAD PCB files for robots to achieve fast interchangeable production
- Auto calibration function compensates deviation caused by tool changes
- The solution adopts Delta industrial automation products for easy integration and maintenance

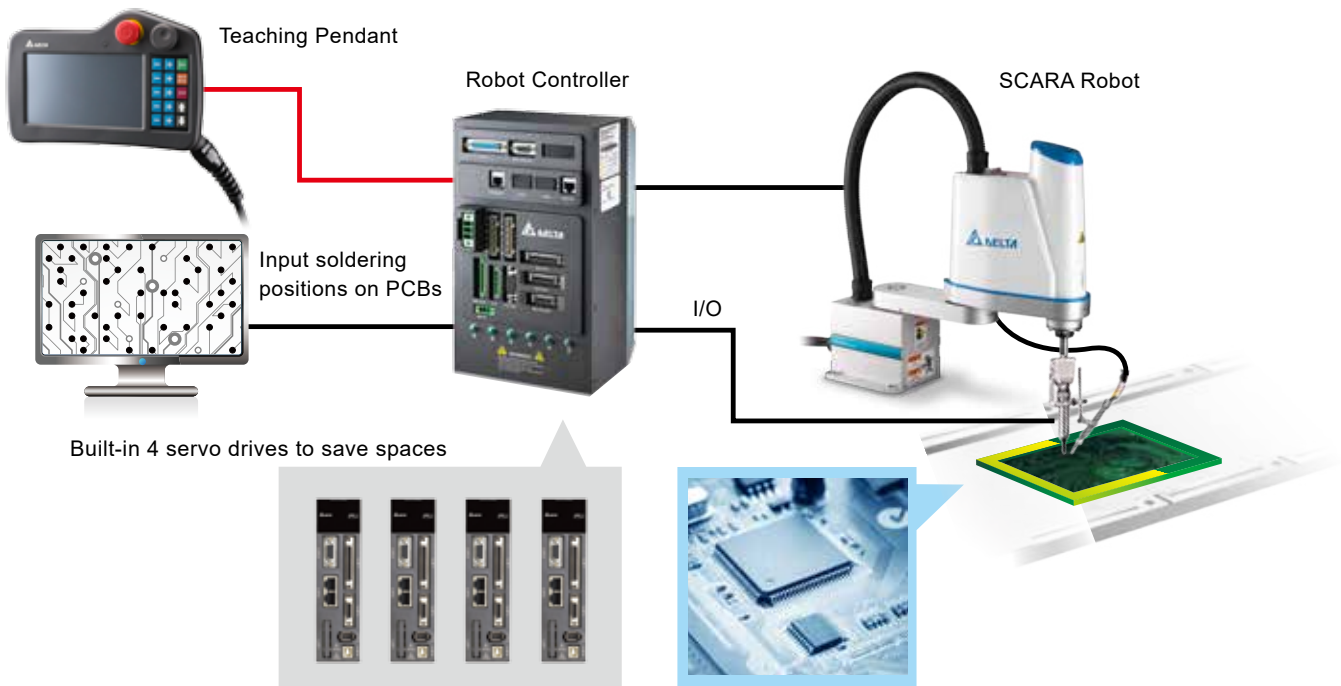

Automatic Screw-locking Solution

- Robot controller with servo drive integrated saves spaces and wiring
- SCARA delivers consistent quality with high repeatability
- Flexible robot teaching movement and motion control for interchangeable production
- The solution adopts Delta industrial automation products for easy integration and maintenance

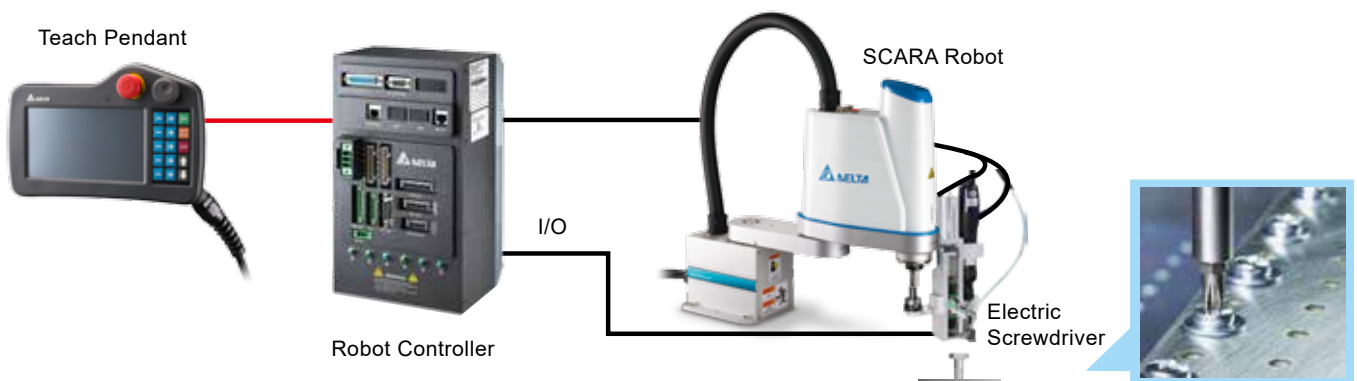



Smarter. Greener. Together.

Industrial Automation Headquarters

Delta Electronics, Inc.

Taoyuan Technology Center
No.18, Xinglong Rd., Taoyuan District,
Taoyuan City 33068, Taiwan
TEL: 886-3-362-6301 / FAX: 886-3-371-6301

Asia

Delta Electronics (Shanghai) Co., Ltd.

No.182 Minyu Rd., Pudong Shanghai, P.R.C.
Post code : 201209
TEL: 86-21-6872-3988 / FAX: 86-21-6872-3996
Customer Service: 400-820-9595

Delta Electronics (Japan), Inc.

Tokyo Office
Industrial Automation Sales Department
2-1-14 Shibadaimon, Minato-ku
Tokyo, Japan 105-0012
TEL: 81-3-5733-1155 / FAX: 81-3-5733-1255

Delta Electronics (Korea), Inc.

Seoul Office
1511, 219, Gasan Digital 1-Ro., Geumcheon-gu,
Seoul, 08501 South Korea
TEL: 82-2-515-5305 / FAX: 82-2-515-5302

Delta Energy Systems (Singapore) Pte Ltd.

4 Kaki Bukit Avenue 1, #05-04, Singapore 417939
TEL: 65-6747-5155 / FAX: 65-6744-9228

Delta Electronics (India) Pvt. Ltd.

Plot No.43, Sector 35, HSIIDC Gurgaon,
PIN 122001, Haryana, India
TEL: 91-124-4874900 / FAX : 91-124-4874945

Delta Electronics (Thailand) PCL.

909 Soi 9, Moo 4, Bangpoo Industrial Estate (E.P.Z),
Pattana 1 Rd., T.Phraksa, A.Muang,
Samutprakarn 10280, Thailand
TEL: 66-2709-2800 / FAX : 662-709-2827

Delta Electronics (Australia) Pty Ltd.

Unit 20-21/45 Normanby Rd., Notting Hill Vic 3168, Australia
TEL: 61-3-9543-3720

Americas

Delta Electronics (Americas) Ltd.

Raleigh Office
P.O. Box 12173, 5101 Davis Drive,
Research Triangle Park, NC 27709, U.S.A.
TEL: 1-919-767-3813 / FAX: 1-919-767-3969

Delta Electronics Brazil

São Paulo Sales Office
Rua Itapeva, 26 - 3º, andar Edifício Itapeva,
One - Bela Vista 01332-000 - São Paulo - SP - Brazil
TEL: 55-12-3932-2300 / FAX: 55-12-3932-237

Delta Electronics International Mexico S.A. de C.V.

Mexico Office
Gustavo Baz No. 309 Edificio E PB 103
Colonia La Loma, CP 54060
Tlalnepantla, Estado de México
TEL: 52-55-3603-9200

EMEA

Headquarters: Delta Electronics (Netherlands) B.V.

Sales: Sales.IA.EMEA@deltaww.com
Marketing: Marketing.IA.EMEA@deltaww.com
Technical Support: iatechnicalsupport@deltaww.com
Customer Support: Customer-Support@deltaww.com
Service: Service.IA.emea@deltaww.com
TEL: +31(0)40 800 3900

BENELUX: Delta Electronics (Netherlands) B.V.

De Witbogt 20, 5652 AG Eindhoven, The Netherlands
Mail: Sales.IA.Benelux@deltaww.com
TEL: +31(0)40 800 3900

DACH: Delta Electronics (Netherlands) B.V.

Coesterweg 45, D-59494 Soest, Germany
Mail: Sales.IA.DACH@deltaww.com
TEL: +49(0)2921 987 0

France: Delta Electronics (France) S.A.

ZI du bois Challand 2, 15 rue des Pyrénées,
Lisses, 91090 Evry Cedex, France
Mail: Sales.IA.FR@deltaww.com
TEL: +33(0)1 69 77 82 60

Iberia: Delta Electronics Solutions (Spain) S.L.U

Ctra. De Villaverde a Vallecas, 265 1º Dcha Ed.
Hormigueras – P.I. de Vallecas 28031 Madrid
TEL: +34(0)91 223 74 20

Carrer Llacuna 166, 08018 Barcelona, Spain

Mail: Sales.IA.Iberia@deltaww.com

Italy: Delta Electronics (Italy) S.r.l.

Via Meda 2-22060 Novedrate(CO)
Piazza Grazioli 18 00186 Roma Italy
Mail: Sales.IA.Italy@deltaww.com
TEL: +39 039 8900365

Russia: Delta Energy System LLC

Vereyskaya Plaza II, office 112 Vereyskaya str.
17 121357 Moscow Russia
Mail: Sales.IA.RU@deltaww.com
TEL: +7 495 644 3240

Turkey: Delta Greentech Elektronik San. Ltd. Sti. (Turkey)

Şerifaii Mah. Hendem Cad. Kule Sok. No:16-A
34775 Ümraniye – İstanbul
Mail: Sales.IA.Turkey@deltaww.com
TEL: + 90 216 499 9910

GCC: Delta Energy Systems AG (Dubai BR)

P.O. Box 185668, Gate 7, 3rd Floor, Hamarain Centre
Dubai, United Arab Emirates
Mail: Sales.IA.MEA@deltaww.com
TEL: +971(0)4 2690148

Egypt + North Africa: Delta Electronics

Unit 318, 3rd Floor, Trivium Business Complex, North 90 street,
New Cairo, Cairo, Egypt
Mail: Sales.IA.MEA@deltaww.com