

Linear Motor



Technical Information



Linear Motor Stage

Automated transport / AOI application / Precision / Semiconductor

- With Iron-core
- Coreless Type
- Linear Turbo LMT
- Planar Servo Motor
- Air Bearing Platform
- X-Y Stage
- Gantry Systems



Linear Motor

Machine tool / Touch panel industry / Semiconductor industry / Laser manufacturing machine / Glass cutting machine

- Ironcore linear motor-LMFA series, LMSA series, LMSC series
- Ironless linear motor-LMC series, LMT series



Torque Motor (Direct Drive Motor)

Inspection / Testing equipment / Machine tools / Robot

- Rotary Tables-TMS,TMY,TMN
- TMRW Series



AC Servo Motor & Drive

Semiconductor / Packaging machine / SMT / Food industry / LCD

- Drives-D1, D1-N, D2
- Motors-50W-2000W



Linear Actuator

Hospital bed / Automatic window / Home care facility / Riveting / Press-fitting / Surface checks / Bending

- Servo Actuator-LAA series
- LAM series
- LAI series
- LAS series
- LAN series
- LAC series

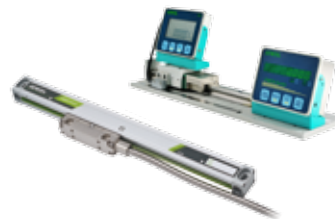

Positioning Measurement System

Cutting machines / Traditional gantry milling machines / Programmable drilling machines

- High Resolution
- Signal Translator
- High-precision Enclosed
- High Efficiency Counter



Multi Axis Robot

Pick-and-place / Assembly / Array and packaging / Semiconductor / Electro-Optical industry / Automotive industry / Food industry

- Articulated Robot
- Delta Robot
- SCARA Robot
- Wafer Robot
- Electric Gripper
- Integrated Electric Gripper
- Rotary Joint



Single Axis Robot

Precision / Semiconductor / Medical / FPD

- KK, SK
- KS, KA
- KU, KE, KC

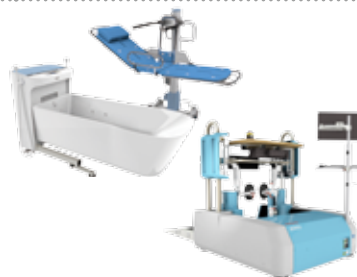

Medical Equipment

Hospital / Rehabilitation centers / Nursing homes

- Robotic Gait Training System
- Hygiene System
- Robotic Endoscopy Holder



Ballscrew

Precision Ground / Rolled

- Super S series
- Super T series
- Mini Roller
- Ecological & Economical lubrication Module E2
- Rotating Nut (R1)
- Energy-Saving & Thermal-Controlling (C1)
- Heavy Load Series (RD)
- Ball Spline

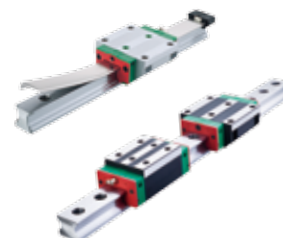

Linear Guideway

Automation / Semiconductor / Medical

- Ball Type--HG, EG, WE, MG, CG
- Quiet Type--QH, QE, QW, QR
- Other--RG, E2, PG, SE, RC

Content Linear Motor Power Range

■ Continuous force
 ■ Continuous force(WC)
 ■ Peak force

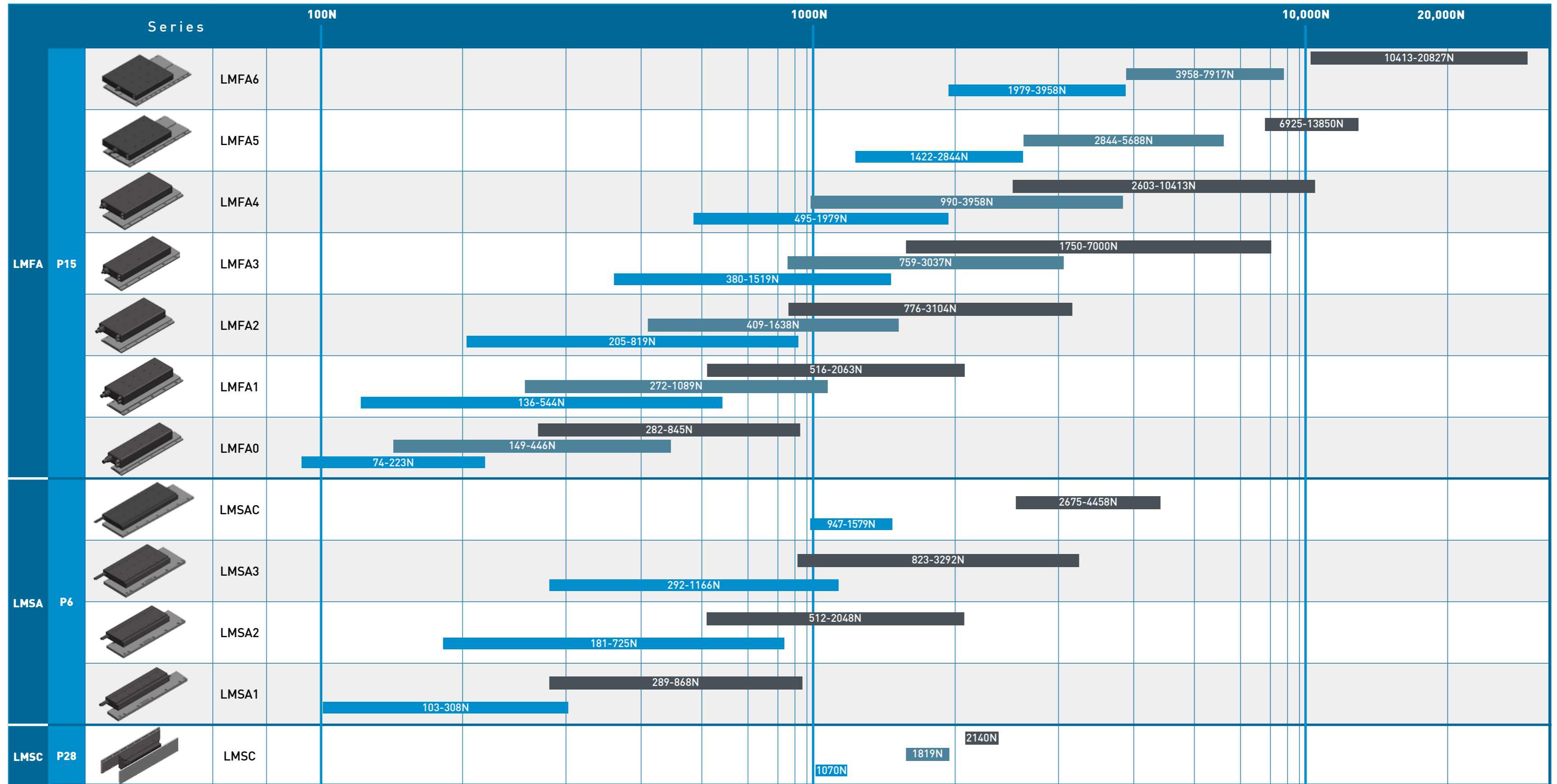

Content Linear Motor Power Range

■ Continuous force ■ Peak force

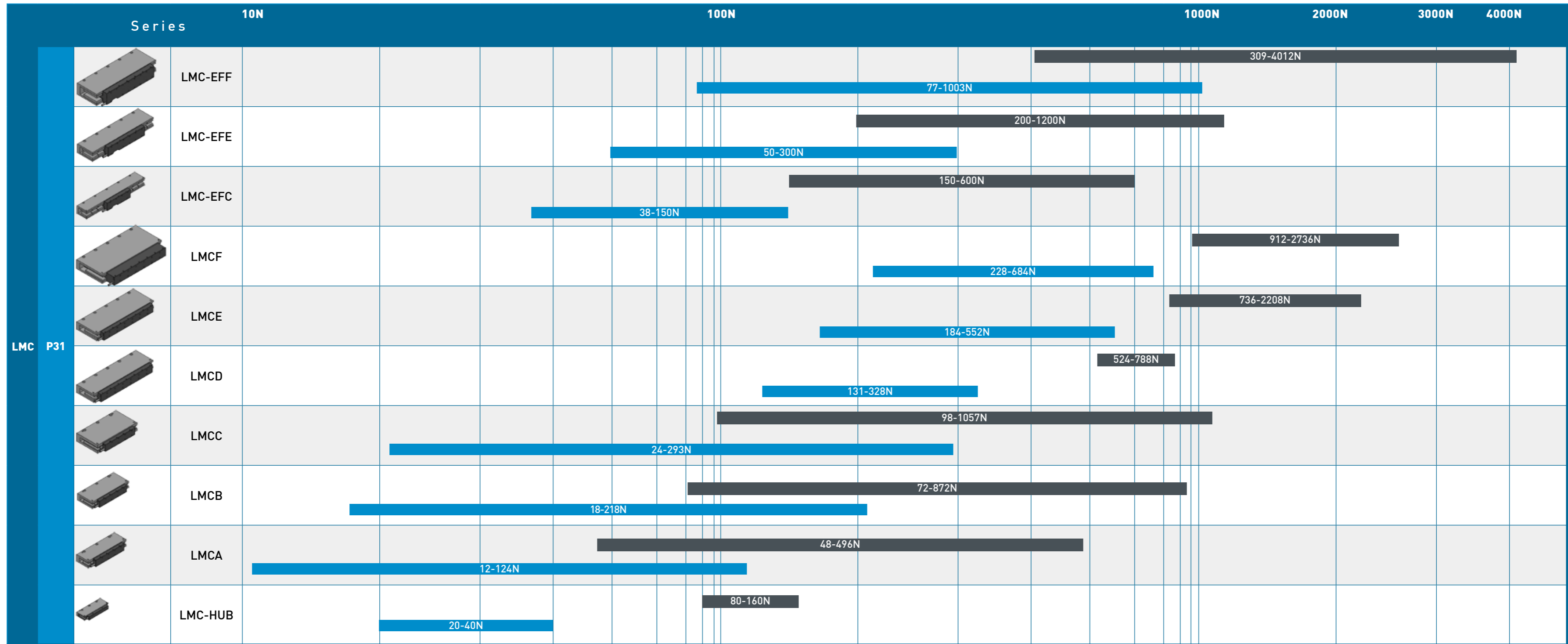

Content Linear Motor Power Range

■ Continuous force ■ Peak force

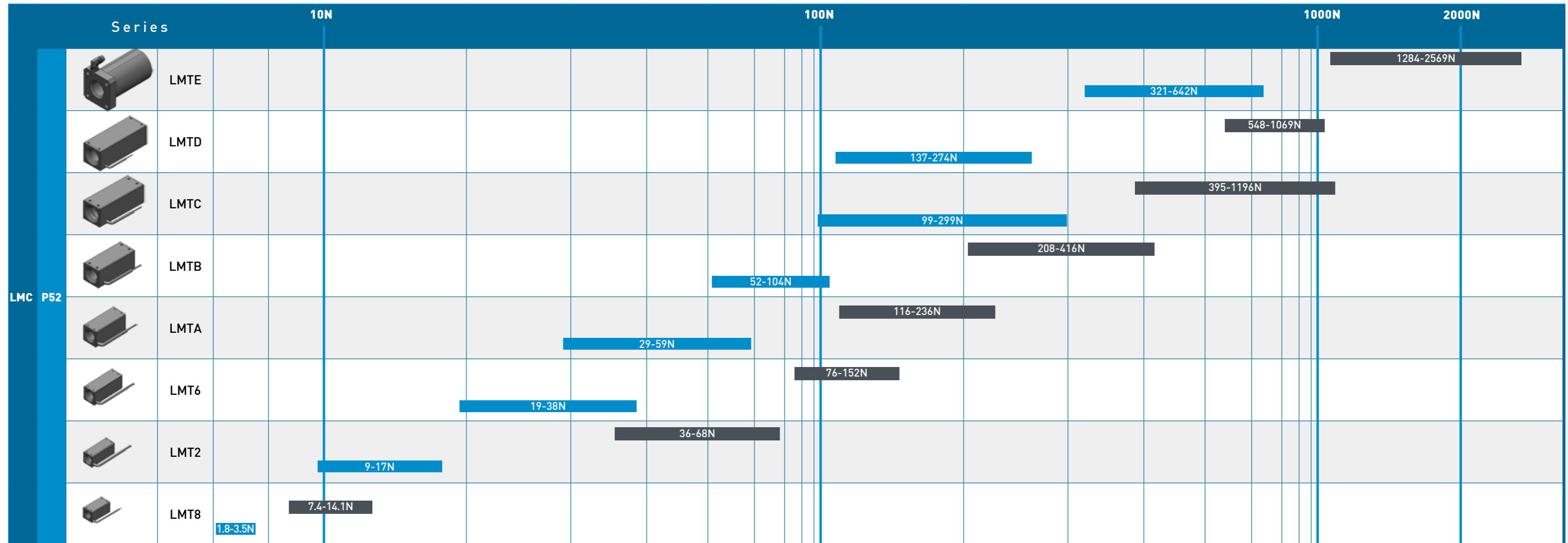

LMC P52

Contents

Linear motor

1. Basic information 04

Introduction to proper nouns.

2. Linear motor 06

HIWIN linear motors can be core-type or non-core-type, core-type linear motor have larger thrust, Non-core-type linear motors are more lightweight, with good dynamic characteristics. There is no drive mechanism between motor and load. A direct drive mechanism is simpler and therefore has excellent dynamic response. In addition, linear motors are designed for non-contact and do not produce wear, accuracy is better, and maintenance is reduced.

2.1 LMSA series	6
2.2 LMFA series	15
2.3 LMSC series	28
2.4 LMC series	31
2.5 LMT series	52

3. Drive 62

Introduction to HIWIN standard drives D1 and D1-N.

3.1 D1 servo drive	62
3.2 D1-N servo drive	67

Appendix 71

The query form at the end of this manual helps us to understand the needs of our customers so that we can conduct a preliminary design.

A : Motor selection	71
B : Regenerative resistor selection	74
C : Linear motor demand specification questionnaire	76

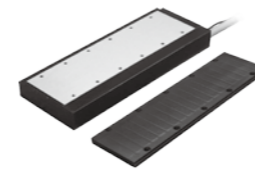

LMSA series :

High thrust density, low cogging force, high dynamic response, low installation height and other characteristics, in line UL and CE certification.

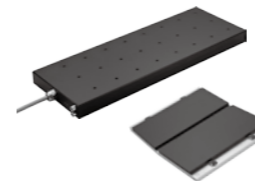

LMFA series :

Built-in water cooling system, with high thrust density, the maximum peak force is up to 20,000N, complied with UL and CE certifications.

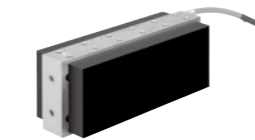

LMSC series :

Built-in water cooling system, attraction force betweenforcer and stator is offset, reducing slide load.



LMC series :

With U-shaped stator coreless linear motor, without attraction force between forcers and stators, no cogging, very low velocity ripple and excellent high acceleration and deceleration dynamic characteristics. Suitable for continuous movement and high precision positioning control applications, and meets CE certification.



LMT series :

Similar to screw structure, with no wear, zero backlash, high velocity, no cogging, low velocity ripple and other excellent features. Satisfies high precision positioning control and smooth operation application requirements, and in line CE certification and IP66 rating.

1 Basic information

1.1 Technical terms | Linear motor

Continuous force F_c (N)

Defined as motor output thrust at ambient temperature 25°C, output thrust under continuous movement without resting, Continuous current I_c corresponding to supplied to motor.

Continuous current I_c (A_{rms})

Defined as current that can be continuously supplied to motor coil at ambient temperature at 25°C and is also constant current.

Peak force F_p (N)

Defined as the maximum thrust that motor can output for no more than one second, generally used for acceleration or deceleration purposes.

Peak current I_p (A_{rms})

Defined as motor reaches Peak force corresponding to instant large current, under normal operating range, Peak current can be allowed to supply for one second.

Ultimate force F_u (N)

Defined as the corresponding output thrust of motor at the Ultimate current I_u .

Ultimate current I_u (A_{rms})

Defined as five times of the motor Continuous current I_c ; at this current, motor outputs thrust in saturated nonlinear region, force constant will be reduced, input current motor has over-temperature risk, recommended operating time is 0.5 seconds or less.

Force constant K_f (N/ A_{rms})

Defined as the output thrust of motor at unit current (A_{rms}), and this parameter is multiplied by current to obtain thrust: $F = I \times K_f$.

Attraction force F_a (N)

Defined as the force between core motor and stator under rated air gap, which forces the preload of guidelay to be supported by rail.

Maximum winding temperature T_{MAX} (°C)

Defined as the maximum permissible temperature of motor coil. Actual equilibrium temperature of motor will depend on factors such as structure, cooling methods, and motion planning, etc. theoretical calculations may be biased, usually based on actual testing.

Electrical time constant K_e (ms)

Defined as the time required for current supplied to motor to reach 63% of target value, the smaller the value, the faster the response time.

Resistance(line to line,25°C) R_{25} (Ω)

Defined as the resistance of motor measured coil temperature at 25°C; resistance value increases with increasing temperature.

Inductance(line to line) L (mH)

Defined as measured motor inductance values line to line.

Pole pair pitch 2τ (mm)

Defined as the distance between two same polar magnets of stator, that is, $N \rightarrow N$ or $S \rightarrow S$ identical magnetic poles.

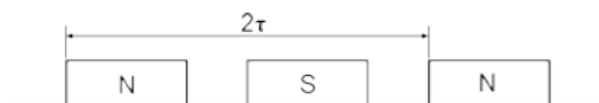

Back emf constant K_v [$V_{rms}/(m/s)$]

Defined as when motor magnet temperature at 25°C, unit velocity generated by induced electromotive force. Occurs when coil senses and generates electromotive force magnetic field when resistance current passes.

Motor constant K_m (N/ \sqrt{W})

Defined as coil and the magnet temperature at 25°C when the motor output thrust to the ratio of square root of power consumption, the higher the motor constant represents the lower power loss when motor outputs a specific thrust, one of indicators to determine motor efficiency.

Thermal resistance R_{TH} (°C/W)

Defined as the resistance of heat from motor coil to heat dissipation environment; the smaller the blocking stands for the same amount of heat input, coil and cooling environment, the smaller the temperature difference the better the cooling effect.

Thermal time constant t_{TH} (s)

Defined as the time required for motor to rise to 63% of the maximum temperature difference of coil under continuous current supply.

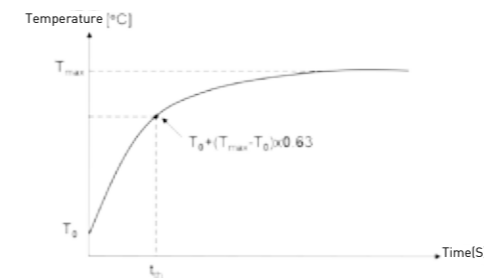

Minimum flow rate (L/min)

Defined as coolant under rated water cooling temperature, the minimum water-cooled flow required for motor to reach Continuous force F_c (WC).

Temperature of cooling water (°C)

Defined as under the minimum flow rate, motor coolant at this temperature to achieve water-cooled Continuous force F_c (WC).

Pressure drop ΔP (bar)

Defined as coolant under the Minimum flow rate, inlet and outlet pressure difference.

Maximum velocity at maximum force $V_{MAX,FP}$ (m/s)

Defined as the maximum velocity that motor can achieve under Peak force; this parameter is required at maximum operating voltage.

Maximum electric power input $P_{EL,MAX}$ (W)

Defined as input power required for motor operation at Maximum velocity at maximum force $V_{MAX,FP}$ with the Maximum dissipated heat output $Q_{P,H,MAX}$ conditions.

Maximum dissipated heat output $Q_{P,H,MAX}$ (W)

Defined as motor heat output at coil under the Maximum winding temperature T_{MAX} .

Stall current I_0 (A_{rms})

Defined as motor at ambient temperature 25°C and stall conditions, the upper limit current can be supplied, this value is related to heat dissipation conditions.

Stall force F_0 (N)

Defined as motor at ambient temperature 25°C and stall conditions, the upper limit of thrust that motor can supply, this value is related to heat dissipation conditions.

Maximum DC bus voltage (V_{DC})

Defined as the maximum operating voltage that motor can use in normal operating conditions.

2 Linear motor

2.1 LMSA series Linear motor

The HIWIN synchronous linear motor LMSA is a larger thrust type of linear drive motor product. It features high thrust density and low cogging force.

The three-phase motor iron core is comprised of a primary side (forcer) and secondary side (stator) permanent magnets. The stator can be infinitely extended, so the stroke will be unrestricted.

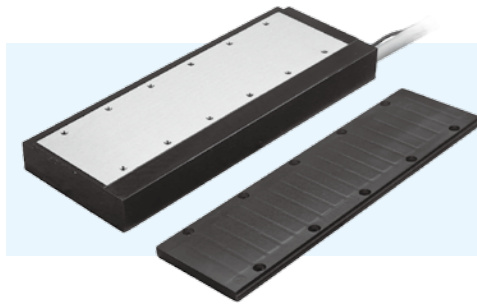

- High dynamic response
- Low installation height
- UL and CE certifications
- Continuous force range from 103N to 1579N
- Peak force range from 289N to 4458N
- Installation height 34mm, 36mm

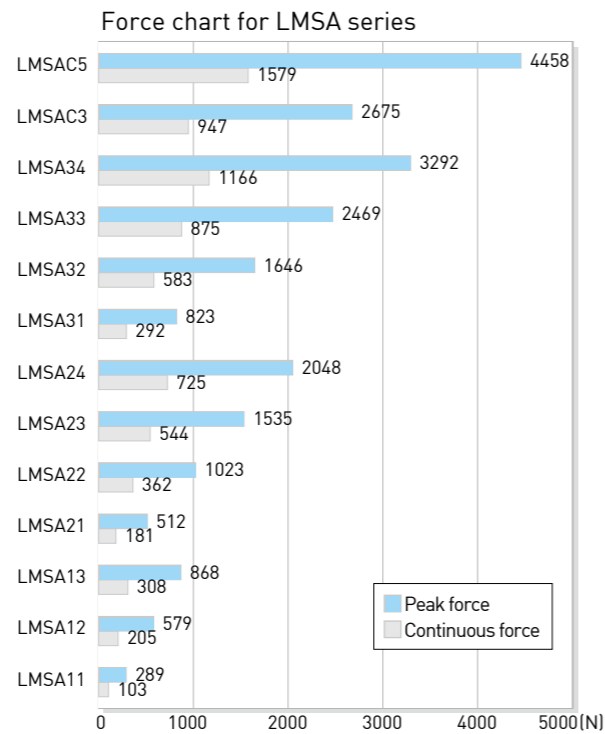

Table 2-1 LMSA series specifications

	Symbol	Unit	LMSA11	LMSA11L	LMSA12	LMSA12L	LMSA13	LMSA13L	LMSA21	LMSA21L	LMSA22	LMSA22L
Continuous force	F_c	N	103	103	205	205	308	308	181	181	362	362
Continuous current	I_c	A_{rms}	2.1	4.7	4.2	9.4	6.3	14.1	2.0	4.4	3.9	8.8
Peak force (1s)	F_p	N	289	289	579	579	868	868	512	512	1023	1023
Peak current (1s)	I_p	A_{rms}	6.3	14.1	12.7	28.3	19.0	42.4	5.9	13.1	11.8	26.3
Ultimate force (0.5s)	F_u	N	379	379	759	759	1138	1138	670	670	1341	1341
Ultimate current (0.5s)	I_u	A_{rms}	10.6	23.6	21.1	47.1	31.7	70.7	9.8	21.9	19.6	43.8
Force constant	K_f	N/ A_{rms}	48.6	21.7	48.6	21.7	48.6	21.7	92.5	41.4	92.5	41.4
Attraction force	F_a	N	481	481	963	963	1444	1444	963	963	1926	1926
Maximum winding temperature	T_{max}	$^{\circ}C$	120									
Electrical time constant	K_e	ms	4.4	4.3	4.5	4.1	4.4	4.0	4.6	4.6	4.9	4.6
Resistance (line to line · 25 $^{\circ}C$)	R_{25}	Ω	8.4	1.7	4.1	0.9	2.8	0.6	13.8	2.8	6.8	1.4
Resistance (line to line · 120 $^{\circ}C$)	R_{120}	Ω	11.6	2.3	5.7	1.2	3.9	0.8	19.0	3.9	9.4	1.9
Inductance (line to line)	L	mH	37.1	7.3	18.5	3.7	12.4	2.4	64.0	12.8	33.0	6.4
Pole pair pitch	2τ	mm	30									
Minimum bending radius of cable	R_{bend}	mm	69									
Back emf constant (line to line)	K_v	$V_{rms}/(m/s)$	28.1	12.6	28.1	12.6	28.1	12.6	53.4	23.9	53.4	23.9
Motor constant	K_m	N/ \sqrt{W}	13.7	13.6	19.6	18.7	23.7	22.9	20.3	20.2	28.9	28.6
Thermal resistance	R_{TH}	$^{\circ}C/W$	1.23	1.23	0.63	0.63	0.41	0.41	0.87	0.87	0.44	0.44
Thermal time constant	t_{TH}	s	1830	1830	2720	2720	4210	4210	2830	2830	4060	4060
Thermal switch	-	-	3 PTC SNM120 In Series									
Maximum DC bus voltage	-	V_{DC}	600									
Mass of forcer	M_f	kg	0.7	0.7	1.4	1.4	2.1	2.1	1.1	1.1	2.2	2.2
Unit mass of stator	M_s	kg/m	2.7	2.7	2.7	2.7	2.7	2.7	4.8	4.8	4.8	4.8
Width of stator	W_s	mm	52	52	52	52	52	52	86	86	86	86
Length of stator/Dimension N	L_s	mm	120mm/N=2, 180mm/N=3, 300mm/N=5									
Stator mounting distance	W_{s1}	mm	42	42	42	42	42	42	74	74	74	74
Total installation height	H	mm	34	34	34	34	34	34	34	34	34	34

Table 2-1 LMSA series specifications

	Symbol	Unit	LMSA23	LMSA23L	LMSA24	LMSA24L	LMSA31	LMSA31L	LMSA32	LMSA32L	LMSA33	LMSA33L
Continuous force	F_c	N	544	544	725	725	292	292	583	583	875	875
Continuous current	I_c	A_{rms}	5.9	13.1	7.8	17.5	2.0	4.5	4.0	8.9	6.0	13.4
Peak force (1s)	F_p	N	1535	1535	2048	2048	823	823	1646	1646	2469	2469
Peak current (1s)	I_p	A_{rms}	17.6	39.4	23.5	52.5	6.0	13.4	12.0	26.8	18.0	40.2
Ultimate force (0.5s)	F_u	N	2011	2011	2682	2682	1079	1079	2157	2157	3236	3236
Ultimate current (0.5s)	I_u	A_{rms}	29.4	65.7	39.2	87.6	10.0	22.3	20.0	44.7	30.0	67.0
Force constant	K_f	N/ A_{rms}	92.5	41.4	92.5	41.4	145.8	65.2	145.8	65.2	145.8	65.2
Attraction force	F_a	N	2888	2888	3851	3851	1444	1444	2888	2888	4333	4333
Maximum winding temperature	T_{max}	$^{\circ}C$	120									
Electrical time constant	K_e	ms	4.9	4.8	4.6	4.7	4.9	4.9	4.9	4.9	4.9	5.0
Resistance (line to line · 25 $^{\circ}C$)	R_{25}	Ω	4.6	0.9	3.5	0.7	19.2	4.0	9.6	2.0	6.4	1.3
Resistance (line to line · 120 $^{\circ}C$)	R_{120}	Ω	6.3	1.2	4.8	0.9	26.5	5.5	13.2	2.8	8.8	1.8
Inductance (line to line)	L	mH	22.4	4.3	16.0	3.2	94.1	19.6	47.1	9.8	31.3	6.5
Pole pair pitch	2τ	mm	30									
Minimum bending radius of cable	R_{bend}	mm	69									
Back emf constant (line to line)	K_v	$V_{rms}/(m/s)$	53.4	23.9	53.4	23.9	84.2	37.7	84.2	37.7	84.2	37.7
Motor constant	K_m	N/ \sqrt{W}	35.2	35.6	40.6	40.8	27.2	26.6	38.4	37.7	47.0	46.7
Thermal resistance	R_{TH}	$^{\circ}C/W$	0.29	0.29	0.22	0.22	0.60	0.60	0.30	0.30	0.20	0.20
Thermal time constant	t_{TH}	s	5080	5080	-	-	4540	4540	5740	5740	5580	5580
Thermal switch	-	-	3 PTC SNM120 In Series									
Maximum DC bus voltage	-	V_{DC}	600									
Mass of forcer	M_f	kg	3.3	3.3	4.4	4.4	1.9	1.9	3.8	3.8	5.7	5.7
Unit mass of stator	M_s	kg/m	4.8	4.8	4.8	4.8	8.5	8.5	8.5	8.5	8.5	8.5
Width of stator	W_s	mm	86	86	86	86	116	116	116	116	116	116
Length of stator/Dimension N	L_s	mm	120mm/N=2, 180mm/N=3, 300mm/N=5									
Stator mounting distance	W_{s1}	mm	74	74	74	74	104	104	104	104	104	104
Total installation height	H	mm	34	34	34	34	36	36	36	36	36	36

Note: 1. The data of this table are values without forced cooling.
 2. Except dimensions, the electrical specifications are in $\pm 10\%$ of tolerance.
 3. We reserve the right to change, please follow customer recognition drawings.

Table 2-1 LMSA series specifications

	Symbol	Unit	LMSA34	LMSA34L	LMSAC3	LMSAC3L	LMSAC5	LMSAC5L
Continuous force	F_c	N	1166	1166	947	947	1579	1579
Continuous current	I_c	A_{rms}	8.0	17.9	6.0	13.4	10.0	22.3
Peak force (1s)	F_p	N	3292	3292	2675	2675	4458	4458
Peak current (1s)	I_p	A_{rms}	24.0	53.6	18.0	40.2	30.0	67.0
Ultimate force (0.5s)	F_u	N	4314	4314	3505	3505	5842	5842
Ultimate current (0.5s)	I_u	A_{rms}	40.0	89.4	30.0	67.0	50.0	111.7
Force constant	K_f	N/A_{rms}	145.8	65.2	157.9	70.7	157.9	70.7
Attraction force	F_a	N	5777	5777	4694	4694	7823	7823
Maximum winding temperature	T_{max}	$^{\circ}C$	120					
Electrical time constant	K_e	ms	4.9	4.9	5.0	5.0	5.0	5.0
Resistance (line to line · 25 $^{\circ}C$)	R_{25}	Ω	4.8	1.0	6.8	1.4	4.1	0.8
Resistance (line to line · 120 $^{\circ}C$)	R_{120}	Ω	6.6	1.4	9.4	1.9	5.7	1.1
Inductance (line to line)	L	mH	23.5	4.9	33.8	6.8	20.3	4.1
Pole pair pitch	2τ	mm	30					
Minimum bending radius of cable	R_{bend}	mm	69					
Back emf constant (line to line)	K_v	$V_{rms}/(m/s)$	84.2	37.7	91.2	40.8	91.2	40.8
Motor constant	K_m	N/\sqrt{W}	54.3	53.3	49.3	49.5	63.7	63.9
Thermal resistance	R_{TH}	$^{\circ}C/W$	0.15	0.14	0.19	0.19	0.11	0.11
Thermal time constant	t_{TH}	s	-	-	-	-	-	-
Thermal switch	-	-	3 PTC SNM120 In Series					
Maximum DC bus voltage	-	V_{DC}	600					
Mass of forcer	M_f	kg	7.6	7.6	6.3	6.3	10.5	10.5
Unit mass of stator	M_s	kg/m	8.5	8.5	9.7	9.7	9.7	9.7
Width of stator	W_s	mm	116	116	126	126	126	126
Length of stator/Dimension N	L_s	mm	120mm/N=2, 180mm/N=3, 300mm/N=5					
Stator mounting distance	W_{s1}	mm	104	104	114	114	114	114
Total installation height	H	mm	36	36	36	36	36	36

Note: 1. The data of this table are values without forced cooling.
 2. Except dimensions, the electrical specifications are in $\pm 10\%$ of tolerance.
 3. We reserve the right to change, please follow customer recognition drawings.

2.1.1 LMSA series F-V curves

■ Force and velocity curve (DC bus voltage = 325 V_{DC})

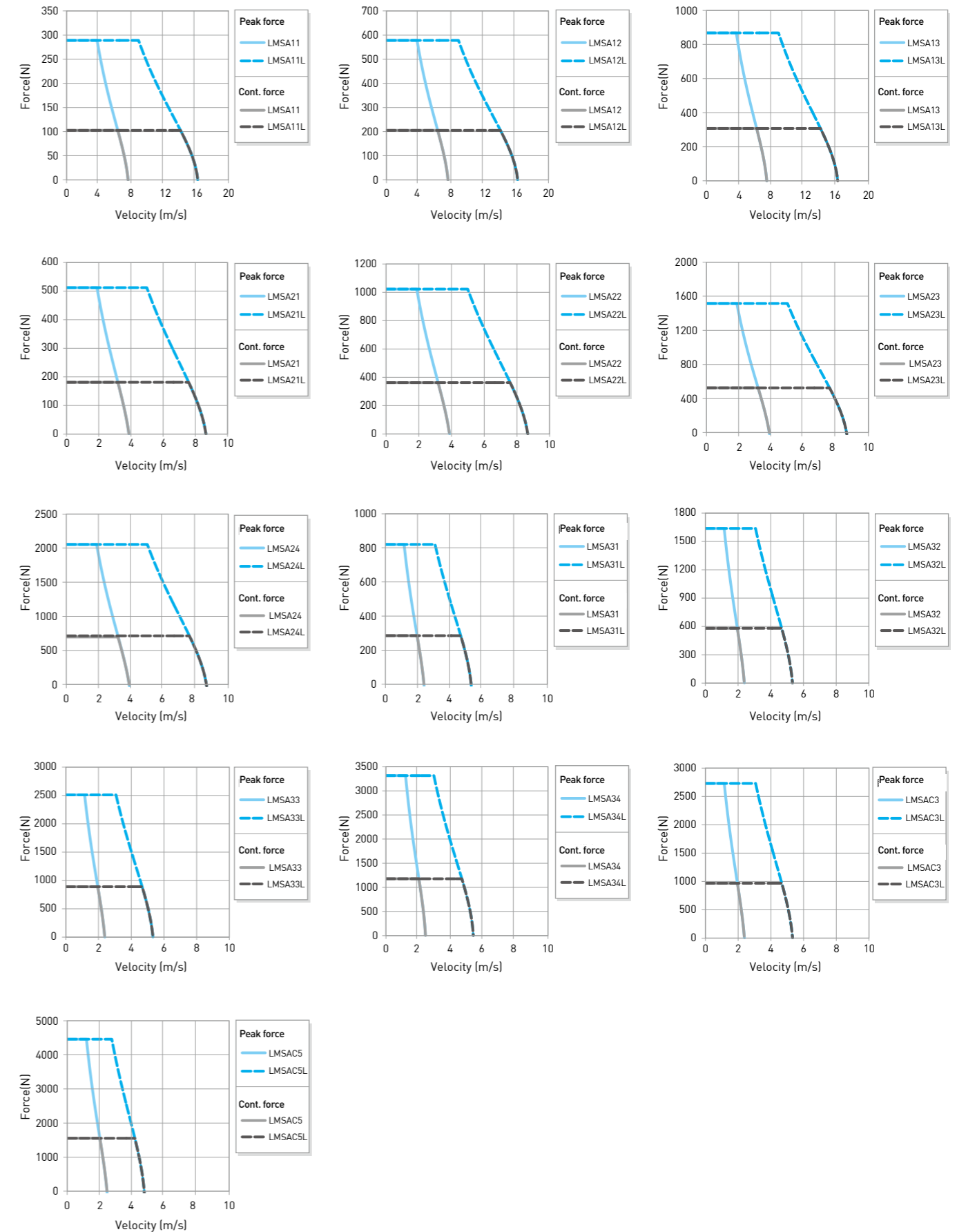

2.1.2 LMSA series forcers and stators dimensions

■ Force and velocity curve(DC bus voltage = 600 V_{DC})

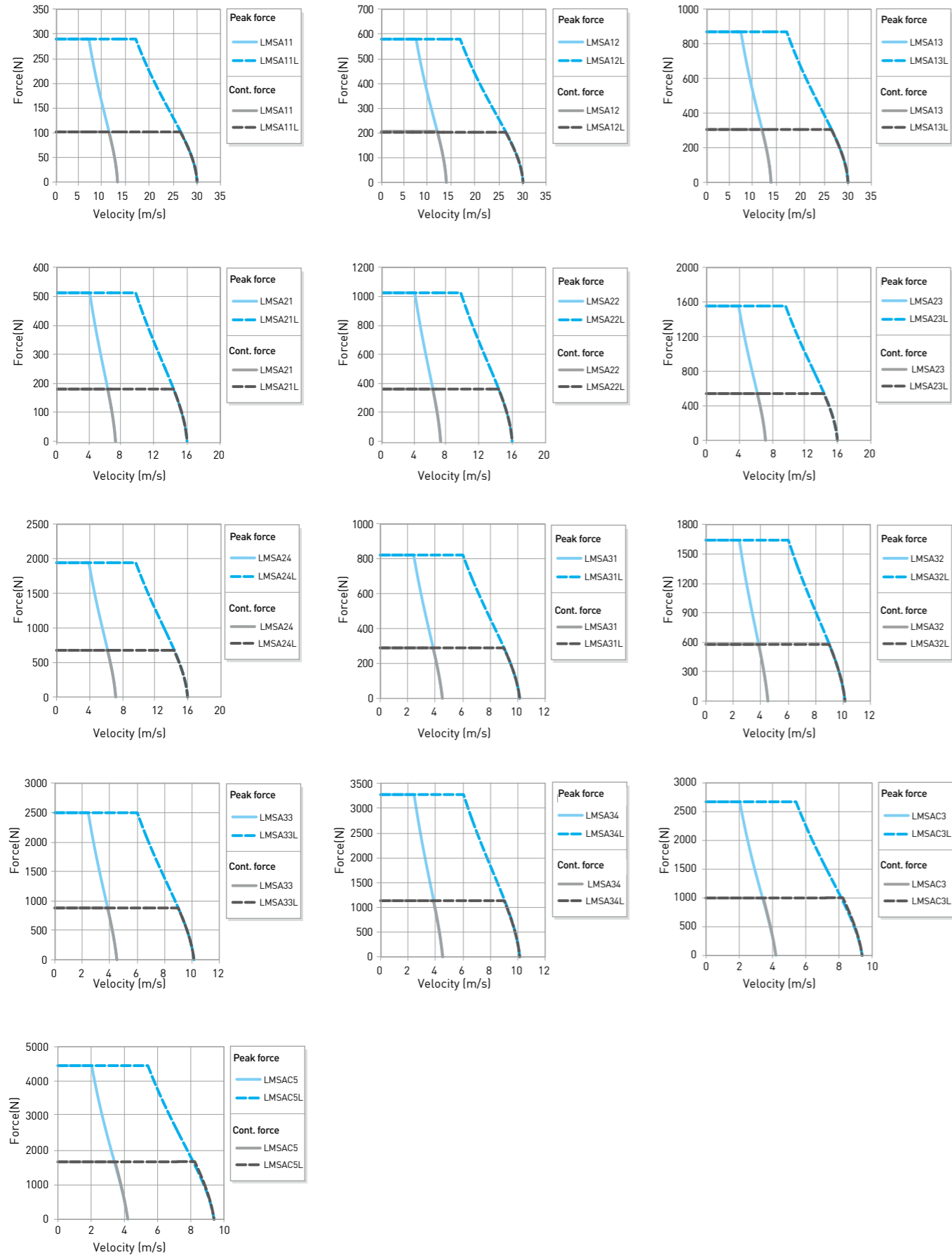

■ Dimensions of forcers

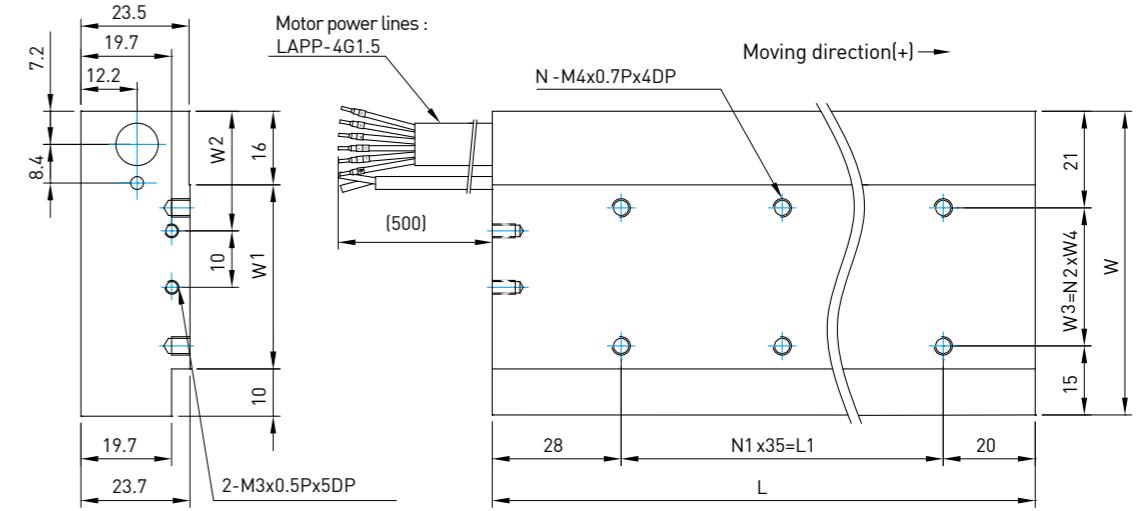

Type	L	L1	W	W1	W2	W3	W4	N	N1	N2
LMSA11	118	70	56	30	26	20	20	6	2	1
LMSA12	223	175	56	30	26	20	20	12	5	1
LMSA13	328	280	56	30	26	20	20	18	8	1
LMSA21	118	70	86	60	41	50	50	6	2	1
LMSA22	223	175	86	60	41	50	50	12	5	1
LMSA23	328	280	86	60	41	50	50	18	8	1
LMSA24	433	385	86	60	41	50	50	24	11	1
LMSA31	118	70	116	90	56	80	40	9	2	2
LMSA32	223	175	116	90	56	80	40	18	5	2
LMSA33	328	280	116	90	56	80	40	27	8	2
LMSA34	433	385	116	90	56	80	40	36	11	2
LMSAC3	328	280	123.5	97.5	59.75	80	40	27	8	2
LMSAC5	538	490	123.5	97.5	59.75	80	40	45	14	2

■ Dimensions of stators

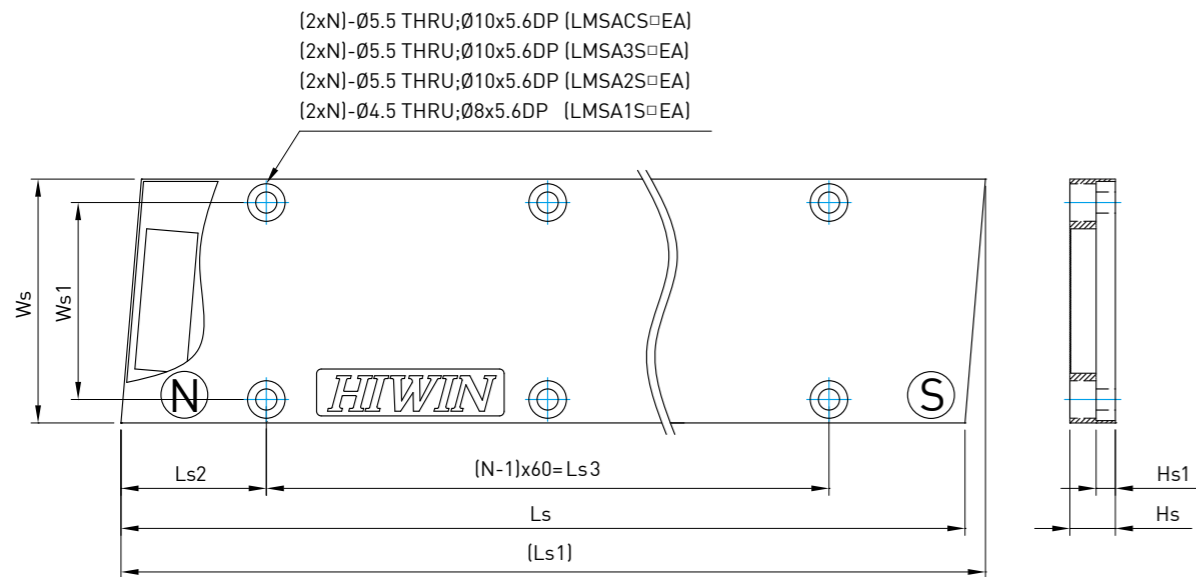
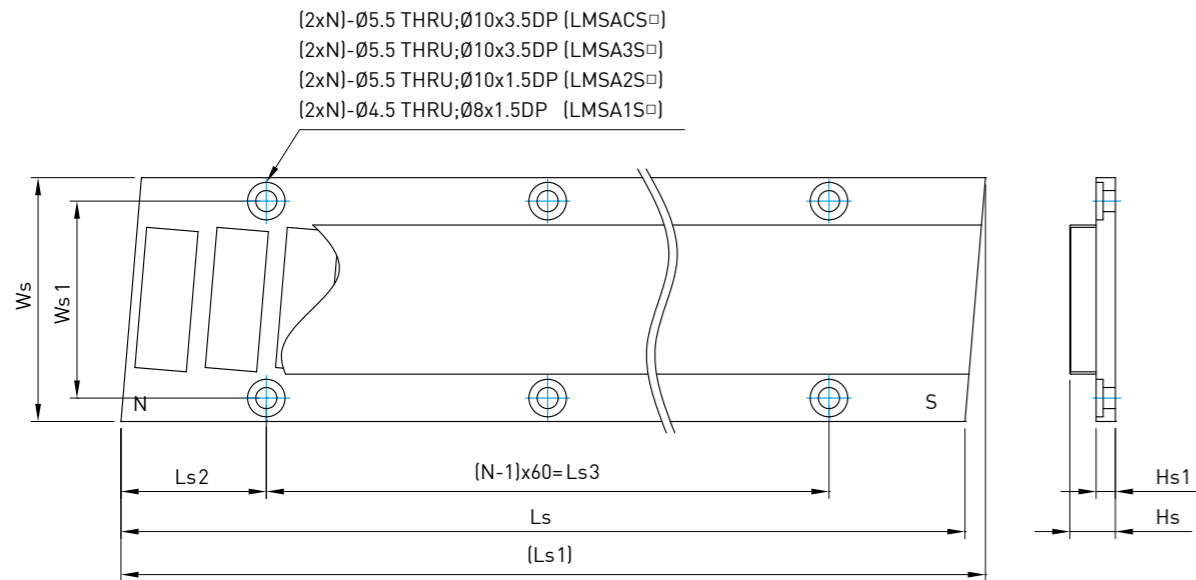

Type	Ls	Ls1	Ls2	Ls3	Ws	Ws1	Hs	Hs1	N
LMSA1S1(EA)	120	124.36	31	60	52	42	9.7	4.1	2
LMSA1S2(EA)	180	184.36	31	120	52	42	9.7	4.1	3
LMSA1S3(EA)	300	304.36	31	240	52	42	9.7	4.1	5
LMSA2S1(EA)	120	122.7	30.57	60	86	74	9.7	4.1	2
LMSA2S2(EA)	180	182.7	30.57	120	86	74	9.7	4.1	3
LMSA2S3(EA)	300	302.7	30.57	240	86	74	9.7	4.1	5
LMSA3S1(EA)	120	123.04	30.37	60	116	104	11.7	6.1	2
LMSA3S2(EA)	180	183.04	30.37	120	116	104	11.7	6.1	3
LMSA3S3(EA)	300	303.04	30.37	240	116	104	11.7	6.1	5
LMSACS1(EA)	120	123.3	30.37	60	126	114	11.7	6.1	2
LMSACS2(EA)	180	183.3	30.37	120	126	114	11.7	6.1	3
LMSACS3(EA)	300	303.3	30.37	240	126	114	11.7	6.1	5

■ Mounting tolerances

LMSA1□series

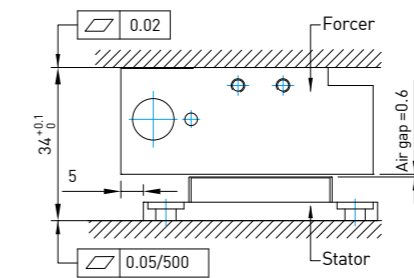

LMSA2□series

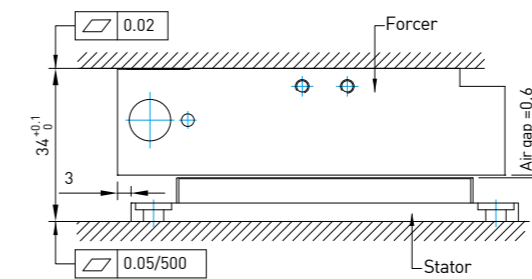

LMSA3□series

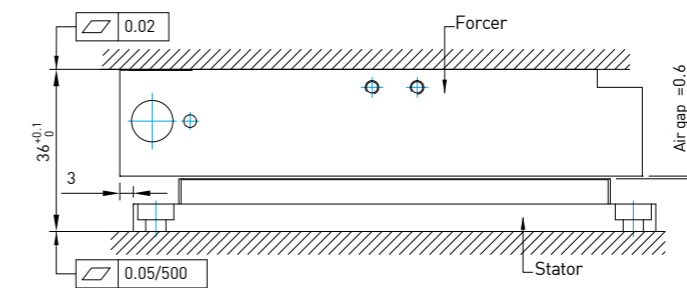

LMSAC□series

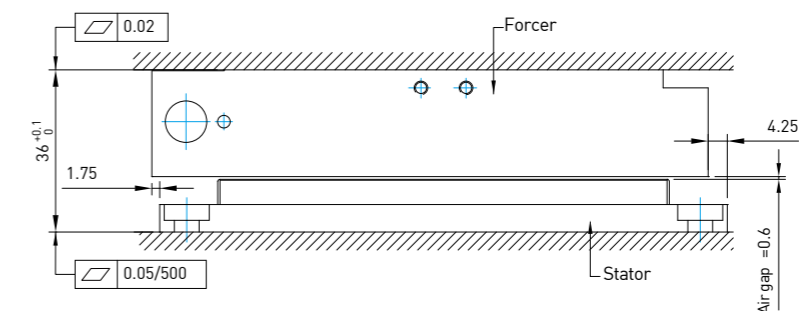

2.1.3 Order code of primary part (forcer)

Series	Type	Width of forcer	Length of forcer	Winding code
LM	SA	1	1	L
Linear motor	Linear motor type	1: 56mm 2: 86mm 3: 116mm C: 123.5mm	1: 118mm 2: 223mm 3: 328mm 4: 433mm 5: 538mm	None:Standard L:Low back EMF

2.1.4 Order code of magnet track (stator)

Series	Type	Width of stator	Model	Length of forcer	Magnet package
LM	SA	1	S	1	EA
Linear motor	Linear motor type	1: 56mm 2: 86mm 3: 116mm C: 126mm	S: Standard C: Customize	1: 120 mm 2: 180 mm 3: 300 mm	EA:Epoxy None:Cover plate

2.2 LMFA series Linear motor

The HIWIN permanent magnet synchronous linear motor LMFA has a built-in water cooling system, with a special electromagnetic and thermal design. This motor has a high thrust density, and the maximum Peak force is up to 20,000N. The three-phase motor is comprised of an iron core primary side (forcer) and a permanent magnet secondary side (stator). The forcer can use multiple units and can be infinitely extended, so motor moving stroke is not restricted. The LMFA series is widely used in the machine tool industry, laser processing machines, glass cutting machines and active vibration suppression platforms.

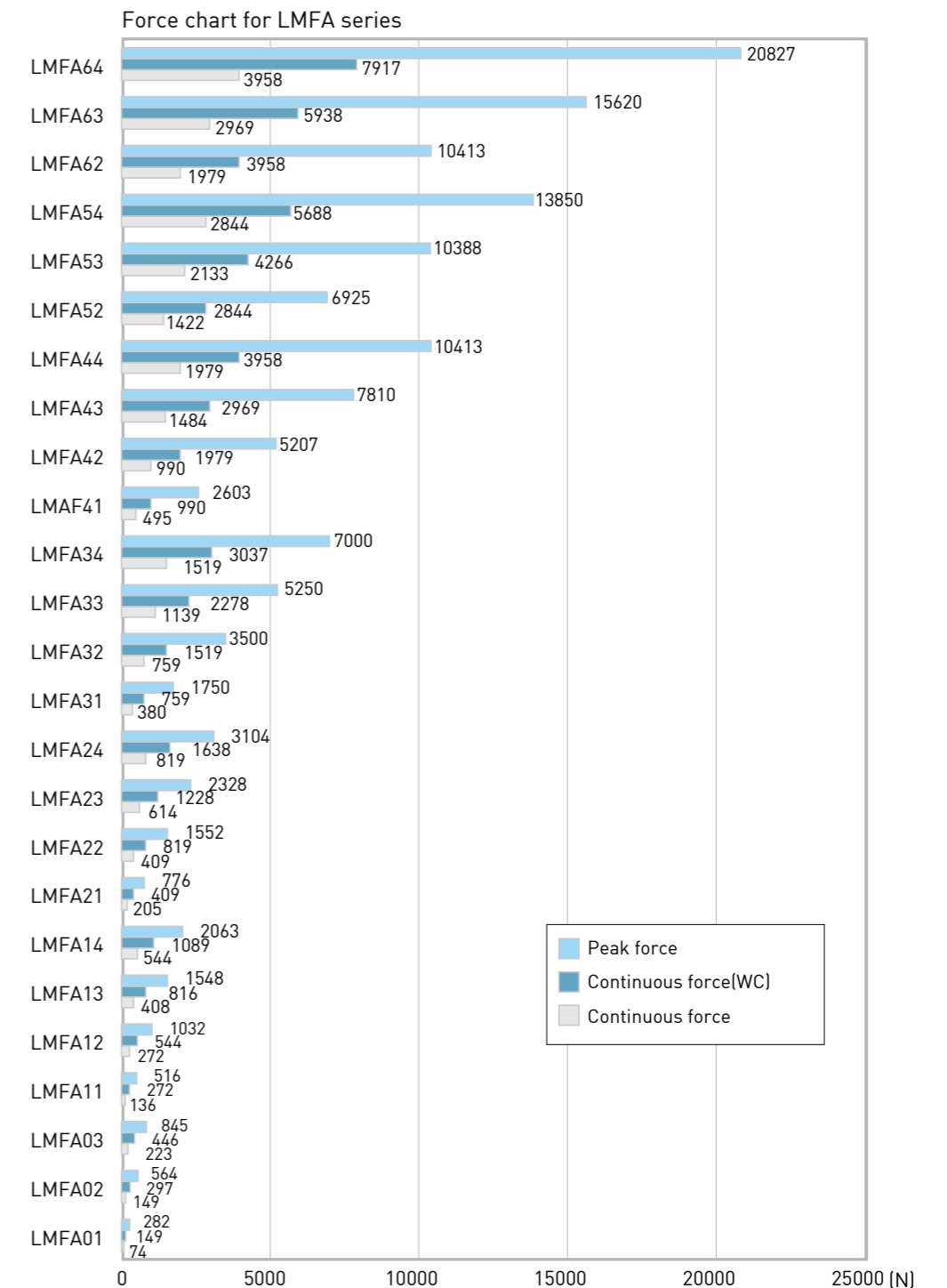
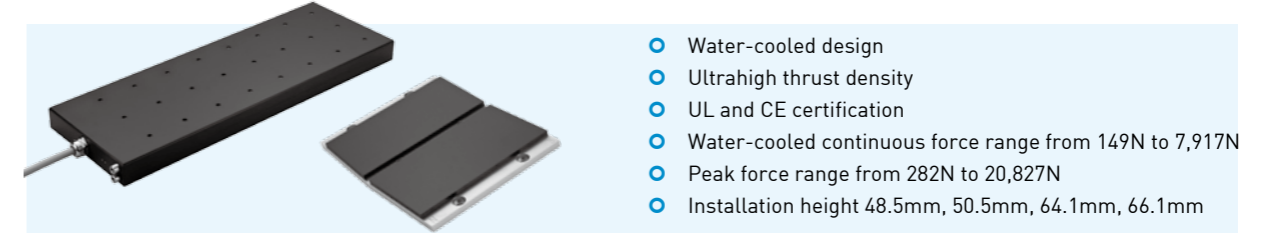

Table 2-2 LMFA series specifications

	Symbol	Unit	LMFA01	LMFA01L	LMFA02	LMFA02L	LMFA03	LMFA03L	LMFA11	LMFA11L	LMFA12	LMFA12L	LMFA13	LMFA13L	LMFA14	LMFA14L
Continuous force	F _c	N	74	74	149	149	223	223	136	136	272	272	408	408	544	544
Continuous current	I _c	A _{rms}	1.4	1.8	2.7	3.6	4.1	5.5	1.4	1.8	2.7	3.6	4.0	5.5	5.4	7.3
Continuous force(WC)	F _c (WC)	N	149	149	297	297	446	446	272	272	544	544	816	816	1089	1089
Continuous current(WC)	I _c (WC)	A _{rms}	2.7	3.6	5.4	7.3	8.1	10.9	2.7	3.6	5.4	7.3	8.1	10.9	10.8	14.6
Peak force (1s)	F _p	N	282	282	564	564	845	845	516	516	1032	1032	1548	1548	2063	2063
Peak current (1s)	I _p	A _{rms}	8.4	11.3	16.7	22.6	25.1	33.9	8.4	11.3	16.7	22.6	25.1	33.9	33.5	45.2
Force constant	K _f	N/A _{rms}	55.1	40.8	55.1	40.8	55.1	40.8	100.8	74.6	100.8	74.6	100.8	74.6	100.8	74.6
Attraction force	F _a	N	457	457	914	914	1372	1372	837	837	1674	1674	2511	2511	3348	3348
Maximum winding temperature	T _{max}	°C	120													
Electrical time constant	K _e	ms	7.2	7.7	7.2	7.7	7.2	7.7	7.2	7.7	7.2	7.7	7.2	7.7	7.2	7.7
Resistance (line to line · 25°C)	R ₂₅	Ω	11.7	6.0	5.9	3.0	3.9	2.0	16.9	8.7	8.4	4.3	5.6	2.9	4.2	2.2
Resistance (line to line · 120°C)	R ₁₂₀	Ω	15.4	7.9	7.7	4.0	5.1	2.6	22.3	11.5	11.1	5.7	7.4	3.8	5.6	2.9
Inductance (line to line)	L	mH	84.2	46.2	42.1	23.1	28.1	15.4	121.9	66.8	60.9	33.4	40.6	22.3	30.5	16.7
Pole pair pitch	2τ	mm	30													
Back emf constant (line to line)	K _v	V _{rms} /(m/s)	31.8	23.5	31.8	23.5	31.8	23.5	58.2	43.1	58.2	43.1	58.2	43.1	58.2	43.1
Motor constant	K _m	N/√W	13.1	13.6	18.6	19.2	22.8	23.5	20.0	20.7	28.3	29.2	34.7	35.8	40.1	41.4
Thermal resistance	R _{TH}	°C/W	2.25	2.40	1.13	1.20	0.75	0.80	1.56	1.66	0.78	0.83	0.52	0.55	0.39	0.42
Thermal resistance(WC)	R _{TH} (WC)	°C/W	0.56	0.60	0.28	0.30	0.19	0.20	0.39	0.42	0.20	0.21	0.13	0.14	0.10	0.10
Thermal time constant	t _{TH}	s	150													
Minimum flow rate	-	L/min	3.3	3.3	3.3	3.3	3.3	3.3	3.7	3.7	3.7	3.7	3.7	3.7	3.7	3.7
Temperature of cooling water	-	°C	20													
Pressure drop	ΔP	bar	0.54	0.54	0.82	0.82	1.1	1.1	0.75	0.75	1.21	1.21	1.67	1.67	2.13	2.13
Thermal switch	-	-	1 x KTY84-130+ 1 x (3 PTC SNM120 In Series)													
Maximum velocity at maximum force	V _{MAX,FP}	m/s	5.39	7.40	5.39	7.40	5.39	7.40	3.44	4.79	3.44	4.79	3.44	4.79	3.44	4.79
Maximum electric power input	P _{EL,MAX}	W	3140	3606	6280	7212	9421	10819	4115	4667	8231	9334	12346	13997	16461	18667
Maximum dissipated heat output	Q _{P,H,MAX}	W	169	158	337	317	506	475	244	228	487	457	731	685	974	914
Stall force(WC)	F ₀	N	104	104	208	208	312	312	191	191	381	381	571	571	762	762
Stall current(WC)	I ₀	A _{rms}	1.9	2.6	3.8	5.1	5.7	7.7	1.9	2.6	3.8	5.1	5.7	7.7	7.6	10.2
Maximum DC bus voltage	-	V _{DC}	750													
Mass of forcer	M _f	kg	1.5	1.5	2.3	2.3	3.1	3.1	2.4	2.4	4	4	5.6	5.6	7.6	7.6
Unit mass of stator	M _s	kg/m	3.7	3.7	3.7	3.7	3.7	3.7	5.8	5.8	5.8	5.8	5.8	5.8	5.8	5.8
Width of stator	W _s	mm	58	58	58	58	58	58	88	88	88	88	88	88	88	88
Length of stator/Dimension N	L _s	mm	120mm/N=2 · 180mm/N=3 · 300mm/N=5													
Stator mounting distance	W _{s1}	mm	48	48	48	48	48	48	74	74	74	74	74	74	74	74
Total installation height	H	mm	48.5													

Note: 1. WC-water cooling.
 2. LMFA forcer is collocated with LMF stators.
 3. Except dimensions,the electrical specifications are in ±10% of tolerance.
 4. We reserve the right to change, please follow customer recognition drawings.

Table 2-2 LMFA series specifications

	Symbol	Unit	LMFA21	LMFA21L	LMFA22	LMFA22L	LMFA23	LMFA23L	LMFA24	LMFA24L	LMFA24L	LMFA31	LMFA31L	LMFA32	LMFA32L	LMFA33	LMFA33L	
Continuous force	F _c	N	205	205	409	409	614	614	819	819	380	380	759	759	1139	1139		
Continuous current	I _c	A _{rms}	1.4	1.8	2.7	3.6	4.1	5.5	5.4	7.3	3.1	4.6	6.2	9.1	9.3	13.7		
Continuous force(WC)	F _c (WC)	N	409	409	819	819	1228	1228	1638	1638	759	759	1519	1519	2278	2278		
Continuous current(WC)	I _c (WC)	A _{rms}	2.7	3.6	5.4	7.3	8.1	10.9	10.8	14.6	6.2	9.1	12.4	18.3	18.6	27.4		
Peak force (1s)	F _p	N	776	776	1552	1552	2328	2328	3104	3104	1750	1750	3500	3500	5250	5250		
Peak current (1s)	I _p	A _{rms}	8.4	11.3	16.7	22.6	25.1	33.9	33.5	45.2	19.2	28.3	38.4	56.6	57.5	84.9		
Force constant	K _f	N/A _{rms}	151.6	112.2	151.6	112.2	151.6	112.2	151.6	112.2	122.7	83.1	122.7	83.1	122.7	83.1		
Attraction force	F _a	N	1259	1259	2518	2518	3777	3777	5036	5036	3430	3430	6860	6860	10290	10290		
Maximum winding temperature	T _{max}	°C	120															
Electrical time constant	K _e	ms	7.2	7.7	7.2	7.7	7.2	7.7	7.2	7.7	7.2	7.7	7.2	7.7	7.2	7.7		
Resistance (line to line · 25°C)	R ₂₅	Ω	24.8	12.7	12.4	6.4	8.3	4.2	6.2	3.2	4.3	1.9	2.1	1.0	1.4	0.6		
Resistance (line to line · 120°C)	R ₁₂₀	Ω	32.7	16.8	16.4	8.4	10.9	5.6	8.2	4.2	5.6	2.6	2.8	1.3	1.9	0.9		
Inductance (line to line)	L	mH	178.6	97.8	89.3	48.9	59.5	32.6	44.6	24.5	48.3	22.2	24.2	11.1	16.1	7.4		
Pole pair pitch	2τ	mm	30										46					
Back emf constant (line to line)	K _v	V _{rms} /(m/s)	87.5	64.8	87.5	64.8	87.5	64.8	87.5	64.8	87.5	64.8	70.9	48.0	70.9	48.0	48.0	
Motor constant	K _m	N/√W	24.9	25.7	35.2	36.3	43.1	44.5	49.7	51.3	48.4	48.7	68.5	68.9	83.9	84.4		
Thermal resistance	R _{TH}	°C/W	1.06	1.13	0.53	0.57	0.35	0.38	0.27	0.28	1.17	1.19	0.59	0.59	0.39	0.40		
Thermal resistance(WC)	R _{TH} (WC)	°C/W	0.27	0.28	0.13	0.14	0.09	0.09	0.07	0.07	0.29	0.30	0.15	0.15	0.10	0.10		
Thermal time constant	t _{TH}	s	150															
Minimum flow rate	-	L/min	4.0	4.0	4.0	4.0	4.0	4.0	4.0	4.0	4.0	4.0	4.0	5.2	5.2	5.7	5.7	
Temperature of cooling water	-	°C	20															
Pressure drop	ΔP	bar	1.15	1.15	1.83	1.83	2.5	2.5	3.18	3.18	0.57	0.57	0.74	0.74	0.98	0.98		
Thermal switch	-	-	1 x KTY84-130+ 1 x (3 PTC SNM120 In Series)															
Maximum velocity at maximum force	V _{MAX,FP}	m/s	2.21	3.14	2.21	3.14	2.21	3.14	2.21	3.14	2.21	3.14	4.08	6.19	4.08	6.19	4.08	
Maximum electric power input	P _{EL,MAX}	W	5152	5661	10304	11321	15455	16982	20607	22643	10255	13910	20509	27821	30764	41731		
Maximum dissipated heat output	Q _{P,H,MAX}	W	358	336	715	671	1073	1007	1431	1342	324	320	648	641	972	961		
Stall force(WC)	F ₀	N	287	287	573	573	860	860	1146	1146	531	531	1063	1063	1594	1594		
Stall current(WC)	I ₀	A _{rms}	1.9	2.6	3.8	5.1	5.7	7.7	7.6	10.2	4.3	6.4	8.7	12.8	13.0	19.2		
Maximum DC bus voltage	-	V _{DC}	750															
Mass of forcer	M _f	kg	3.2	3.2	5.5	5.5	8	8	10.4	10.4	6.4	6.4	11.7	11.7	17.3	17.3		
Unit mass of stator	M _s	kg/m	9.8	9.8	9.8	9.8	9.8	9.8	9.8	9.8	16.2	16.2	16.2	16.2	16.2	16.2		
Width of stator	W _s	mm	118	118	118	118	118	118	118	118	134	134	134	134	134	134		
Length of stator/Dimension N	L _s	mm	120mm/N=2 · 180mm/N=3 · 300mm/N=5										184mm/N=2 · 276mm/N=3 · 460mm/N=5					
Stator mounting distance	W _{s1}	mm	104	104	104	104	104	104	104	104	115	115	115	115	115	115		
Total installation height	H	mm	50.5	50.5	50.5	50.5	50.5	50.5	50.5	50.5	64.1	64.1	64.1	64.1	64.1	64.1		

Note: 1. WC-water cooling.
 2. LMFA forcer is collocated with LMF stators.
 3. Except dimensions,the electrical specifications are in ±10% of tolerance.
 4. We reserve the right to change, please follow customer recognition drawings.

Table 2-2 LMFA series specifications

	Symbol	Unit	LMFA34	LMFA34L	LMFA41	LMFA41L	LMFA42	LMFA42L	LMFA43	LMFA43L	LMFA44	LMFA44L	LMFA52	LMFA52L	LMFA53	LMFA53L
Continuous force	F_c	N	1519	1519	495	495	990	990	1484	1484	1979	1979	1422	1422	2133	2133
Continuous current	I_c	A_{rms}	12.4	18.3	2.9	4.3	5.8	8.5	8.7	12.8	11.5	17.0	6.2	9.1	9.3	13.7
Continuous force(WC)	$F_c(WC)$	N	3037	3037	990	990	1979	1979	2969	2969	3958	3958	2844	2844	4266	4266
Continuous current(WC)	$I_c(WC)$	A_{rms}	24.7	36.5	5.8	8.5	11.5	17.0	17.3	25.6	23.1	34.1	12.4	18.3	18.6	27.4
Peak force (1s)	F_p	N	7000	7000	2603	2603	5207	5207	7810	7810	10413	10413	6925	6925	10388	10388
Peak current (1s)	I_p	A_{rms}	76.7	113.3	17.9	26.4	35.8	52.9	53.5	79.3	71.6	105.7	38.4	56.6	57.5	84.9
Force constant	K_f	N/A_{rms}	122.7	83.1	171.4	116.1	171.4	116.1	171.4	116.1	171.4	116.1	229.9	155.7	229.9	155.7
Attraction force	F_a	N	13720	13720	5145	5145	10290	10290	15435	15435	20580	20580	13700	13700	20550	20550
Maximum winding temperature	T_{max}	°C	120													
Electrical time constant	K_e	ms	11.3	11.4	12.0	12.1	12.0	12.1	12.0	12.1	12.0	12.1	12.2	12.4	12.2	12.4
Resistance (line to line · 25°C)	R_{25}	Ω	1.1	0.5	6.0	2.7	3.0	1.4	2.0	0.9	1.5	0.7	3.9	1.8	2.6	1.2
Resistance (line to line · 120°C)	R_{120}	Ω	1.4	0.6	7.9	3.6	4.0	1.8	2.6	1.2	2.0	0.9	5.1	2.3	3.4	1.6
Inductance (line to line)	L	mH	12.1	5.5	72.0	33.0	36.0	16.5	24.0	11.0	18.0	8.3	47.7	21.9	31.8	14.6
Pole pair pitch	2τ	mm	46													
Back emf constant (line to line)	K_v	$V_{rms}/(m/s)$	70.9	48.0	98.9	67.0	98.9	67.0	98.9	67.0	98.9	67.0	132.7	89.9	132.7	89.9
Motor constant	K_m	N/\sqrt{W}	96.9	97.4	57.1	57.5	80.8	81.3	98.9	99.5	114.2	114.9	95.0	95.6	116.4	117.1
Thermal resistance	R_{TH}	°C/W	0.29	0.30	0.96	0.97	0.48	0.49	0.32	0.32	0.24	0.24	0.32	0.33	0.21	0.22
Thermal resistance(WC)	$R_{TH}(WC)$	°C/W	0.07	0.07	0.24	0.24	0.12	0.12	0.08	0.08	0.06	0.06	0.08	0.08	0.05	0.05
Thermal time constant	t_{TH}	s	150													
Minimum flow rate	-	L/min	6.2	6.2	5.2	5.2	5.2	5.2	5.7	5.7	6.2	6.2	6.3	6.3	6.8	6.8
Temperature of cooling water	-	°C	20													
Pressure drop	ΔP	bar	1.28	1.28	0.89	0.89	1.17	1.17	1.45	1.45	1.8	1.8	1.25	1.25	1.77	1.77
Thermal switch	-	-	1 x KTY84-130+ 1 x (3 PTC SNM120 In Series)													
Maximum velocity at maximum force	$V_{MAX,FP}$	m/s	4.08	6.19	2.61	4.01	2.61	4.01	2.61	4.01	2.61	4.01	1.92	3.04	1.92	3.04
Maximum electric power input	$P_{EL,MAX}$	W	41019	55642	10598	14198	21197	28396	31691	42594	42393	56792	24645	32267	36967	48400
Maximum dissipated heat output	$Q_{P,H,MAX}$	W	1296	1281	396	391	792	782	1187	1173	1583	1565	1181	1167	1771	1751
Stall force(WC)	F_0	N	2126	2126	693	693	1385	1385	2078	2078	2771	2771	1991	1991	2986	2986
Stall current(WC)	I_0	A_{rms}	17.3	25.6	4.0	6.0	8.1	11.9	12.1	17.9	16.2	23.9	8.7	12.8	13.0	19.2
Maximum DC bus voltage	-	V_{DC}	750													
Mass of forcer	M_f	kg	22.5	22.5	9.5	9.5	16.2	16.2	23	23	29	29	23.8	23.8	32.3	32.3
Unit mass of stator	M_s	kg/m	16.2	16.2	22.3	22.3	22.3	22.3	22.3	22.3	22.3	22.3	25	25	25	25
Width of stator	W_s	mm	134	134	180	180	180	180	180	180	180	180	240	240	240	240
Length of stator/Dimension N	L_s	mm	184mm/N=2 · 276mm/N=3 · 460mm/N=5													
Stator mounting distance	W_{s1}	mm	115	115	161	161	161	161	161	161	161	161	222	222	222	222
Total installation height	H	mm	64.1	64.1	66.1	66.1	66.1	66.1	66.1	66.1	66.1	66.1	64.1	64.1	64.1	64.1

Note: 1. WC-water cooling.
2. LMFA forcer is collocated with LMF stators.
3. Except dimensions,the electrical specifications are in $\pm 10\%$ of tolerance.
4. We reserve the right to change, please follow customer recognition drawings.

Table 2-2 LMFA series specifications

	Symbol	Unit	LMFA54	LMFA54L	LMFA62	LMFA62L	LMFA63	LMFA63L	LMFA64	LMFA64L
Continuous force	F_c	N	2844	2844	1979	1979	2969	2969	3958	3958
Continuous current	I_c	A_{rms}	12.4	18.3	5.8	11.5	8.7	17.3	11.5	23.1
Continuous force(WC)	$F_c(WC)$	N	5688	5688	3958	3958	5938	5938	7917	7917
Continuous current(WC)	$I_c(WC)$	A_{rms}	24.7	36.5	11.5	23.1	17.3	34.6	23.1	46.2
Peak force (1s)	F_p	N	13850	13850	10413	10413	15620	15620	20827	20827
Peak current (1s)	I_p	A_{rms}	76.7	113.2	35.8	71.6	53.7	107.4	71.3	142.6
Force constant	K_f	N/A_{rms}	229.9	155.7	342.7	171.4	342.7	171.4	342.7	171.4
Attraction force	F_a	N	27400	27400	20580	20580	30870	30870	41160	41160
Maximum winding temperature	T_{max}	°C	120							
Electrical time constant	K_e	ms	12.2	12.4	12.0	12.0	12.0	12.0	12.0	12.0
Resistance (line to line · 25°C)	R_{25}	Ω	2.0	0.9	6.0	1.5	4.0	1.0	3.0	0.8
Resistance (line to line · 120°C)	R_{120}	Ω	2.6	1.2	7.9	2.0	5.3	1.3	4.0	1.0
Inductance (line to line)	L	mH	23.9	10.9	72.0	18.0	48.0	12.0	36.0	9.0
Pole pair pitch	2τ	mm	46							
Back emf constant (line to line)	K_v	$V_{rms}/(m/s)$	132.7	89.9	197.9	98.9	197.9	98.9	197.9	98.9
Motor constant	K_m	N/\sqrt{W}	134.4	135.2	114.2	114.2	139.9	139.9	161.6	161.6
Thermal resistance	R_{TH}	°C/W	0.16	0.16	0.24	0.24	0.16	0.16	0.12	0.12
Thermal resistance(WC)	$R_{TH}(WC)$	°C/W	0.04	0.04	0.06	0.06	0.04	0.04	0.03	0.03
Thermal time constant	t_{TH}	s	150							
Minimum flow rate	-	L/min	7.3	7.3	6.8	6.8	7.3	7.3	7.8	7.8
Temperature of cooling water	-	°C	20							
Pressure drop	ΔP	bar	2.3	2.3	1.64	1.64	2.25	2.25	3	3
Thermal switch	-	-	1 x KTY84-130+ 1 x (3 PTC SNM120 In Series)							
Maximum velocity at maximum force	$V_{MAX,FP}$	m/s	1.92	3.04	1.12	2.61	1.12	2.61	1.12	2.61
Maximum electric power input	$P_{EL,MAX}$	W	49290	64534	26878	42393	40316	63590	53478	84510
Maximum dissipated heat output	$Q_{P,H,MAX}$	W	2362	2334	1583	1583	2375	2375	3166	3166
Stall force(WC)	F_0	N	3982	3982	2771	2771	4156	4156	5542	5542
Stall current(WC)	I_0	A_{rms}	17.3	25.6	8.1	16.2	12.1	24.3	16.2	32.3
Maximum DC bus voltage	-	V_{DC}	750							
Mass of forcer	M_f	kg	40.8	40.8	32.2	32.2	44.2	44.2	56.2	56.2
Unit mass of stator	M_s	kg/m	25	25	40.1	40.1	40.1	40.1	40.1	40.1
Width of stator	W_s	mm	240	240	334	334	334	334	334	334
Length of stator/Dimension N	L_s	mm	184mm/N=2 · 276mm/N=3 · 460mm/N=5							
Stator mounting distance	W_{s1}	mm	222	222	316	316	316	316	316	316
Total installation height	H	mm	64.1	64.1	66.1	66.1	66.1	66.1	66.1	66.1

Note: 1. WC-water cooling.
2. LMFA forcer is collocated with LMF stators.
3. Except dimensions,the electrical specifications are in $\pm 10\%$ of tolerance.
4. We reserve the right to change, please follow customer recognition drawings.

2.2.1 LMFA series F-V curve

■ Force and velocity curve (DC bus voltage = 325 V_{DC})

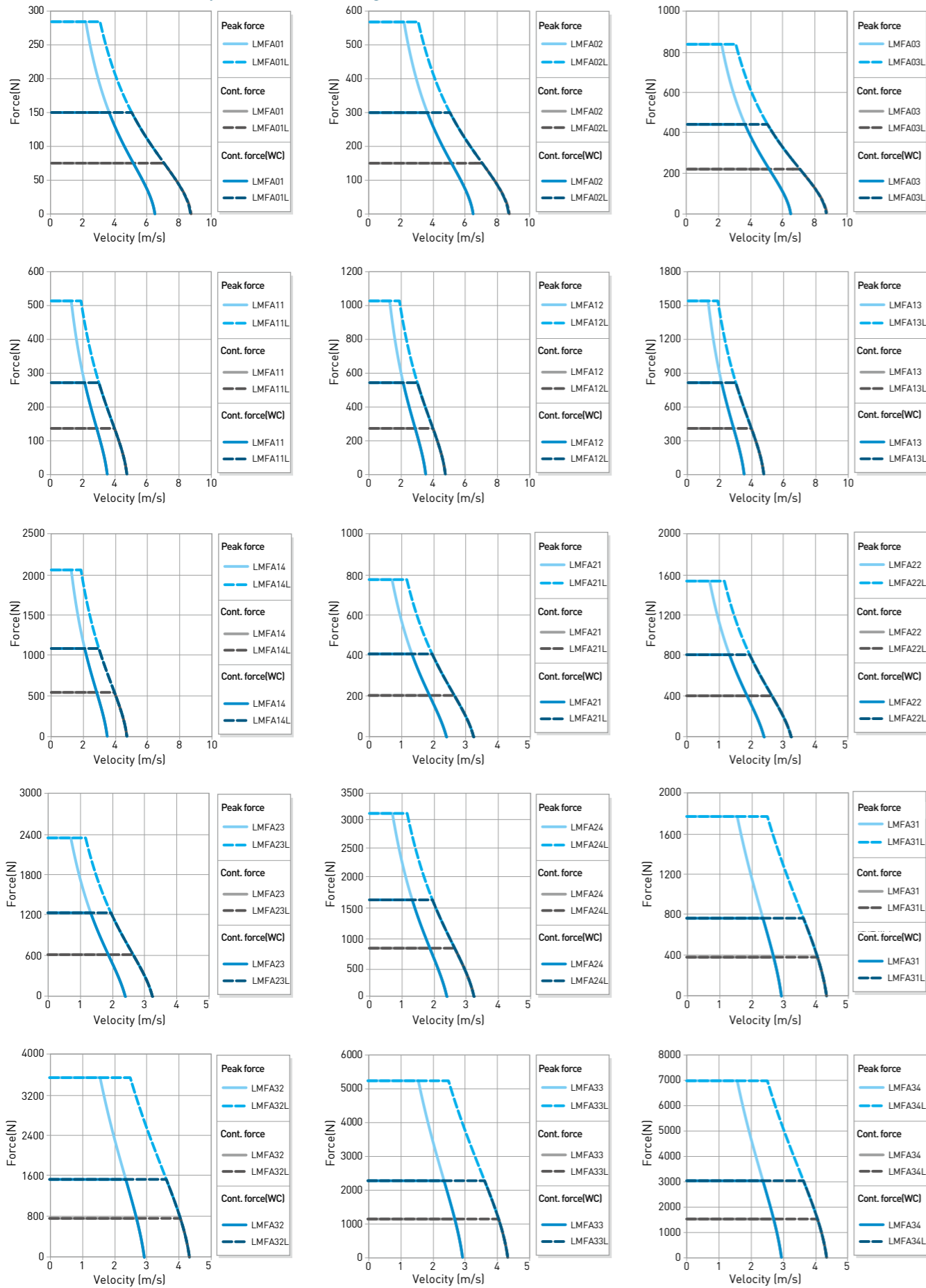

■ Force and velocity curve (DC bus voltage = 325 V_{DC})

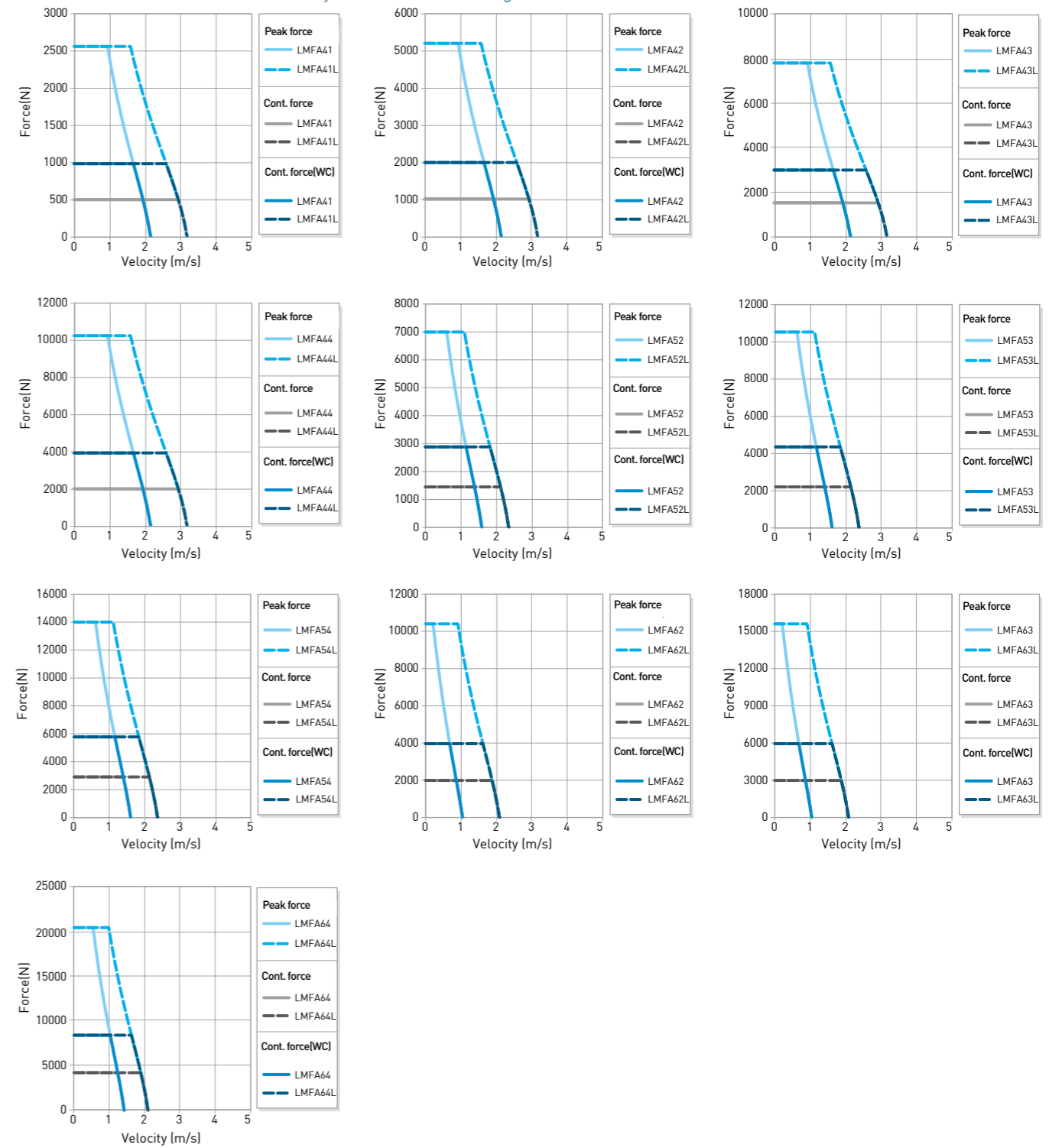

■ Force and velocity curve(DC bus voltage = 750 V_{DC})

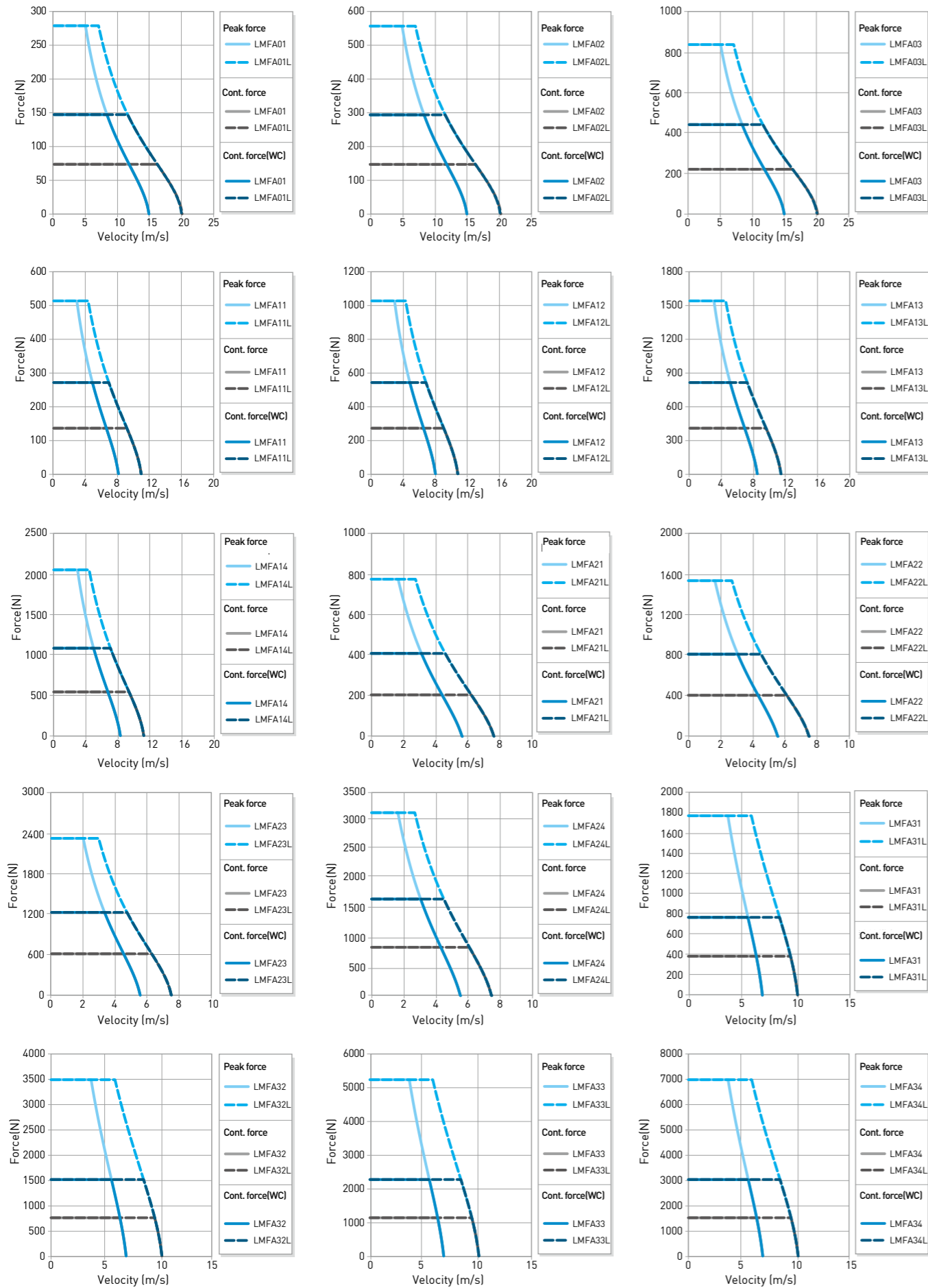

■ Force and velocity curve(DC bus voltage = 750 V_{DC})

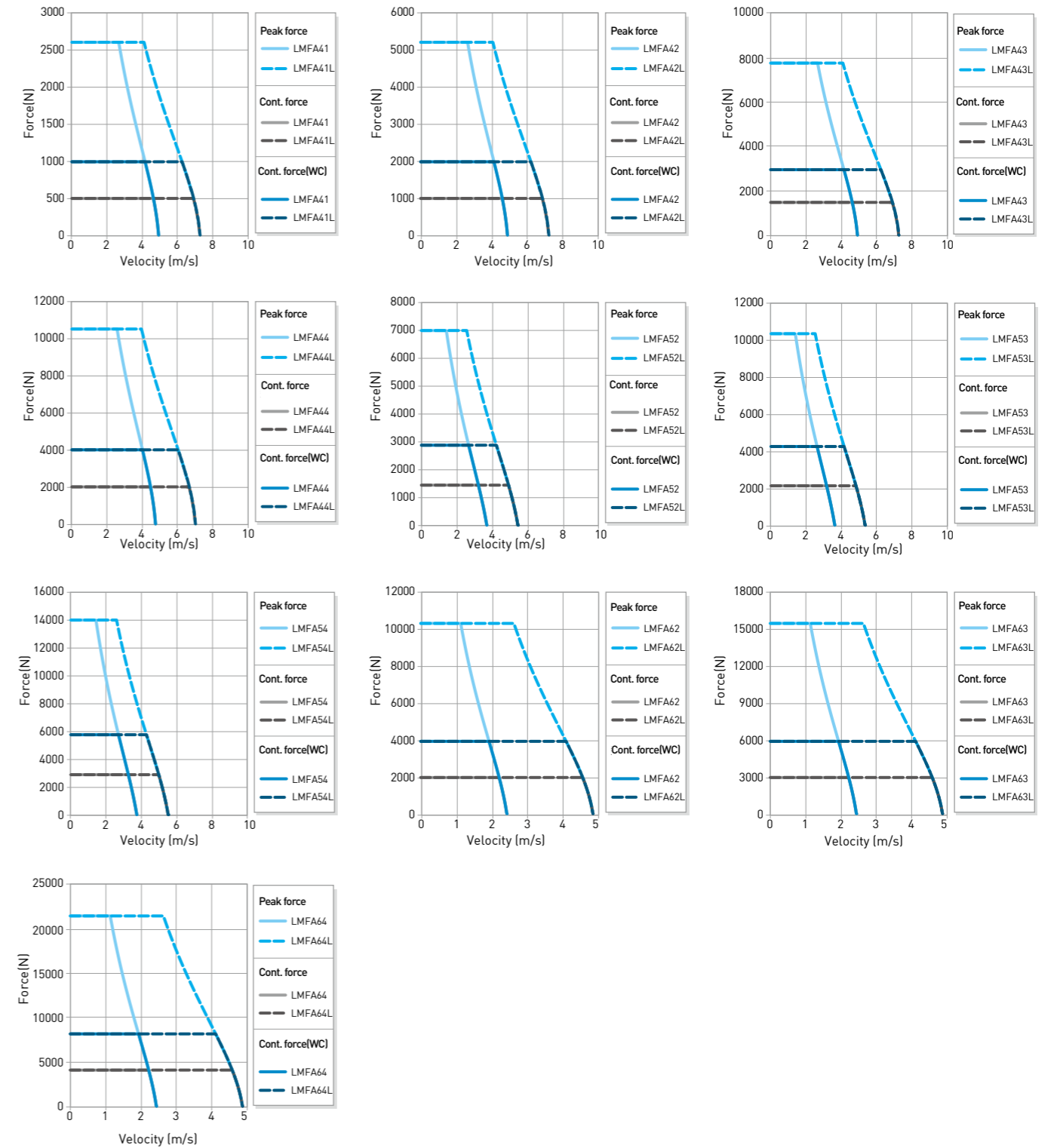

2.2.2 LMFA series forcers and stators dimensions

■ Dimensions of LMFA0,1,2 forcers

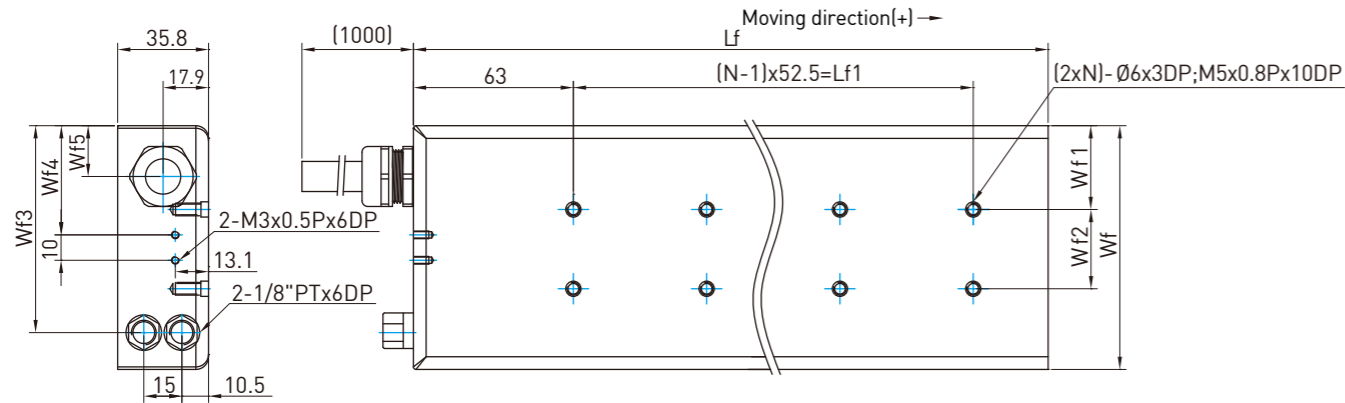

Type	Lf	Lf1	Wf	Wf1	Wf2	Wf3	Wf4	Wf5	N
LMFA01	145	52.5	67	18.5	30	55	33.75	14.4	2
LMFA02	250	157.5	67	18.5	30	55	33.75	14.4	4
LMFA03	355	262.5	67	18.5	30	55	33.75	14.4	6
LMFA11	145	52.5	96	33	30	81.5	43	20	2
LMFA12	250	157.5	96	33	30	81.5	43	20	4
LMFA13	355	262.5	96	33	30	81.5	43	20	6
LMFA14	460	367.5	96	33	30	81.5	43	20	8
LMFA21	145	52.5	126	40.5	45	111.5	58	20	2
LMFA22	250	157.5	126	40.5	45	111.5	58	20	4
LMFA23	355	262.5	126	40.5	45	111.5	58	20	6
LMFA24	460	367.5	126	40.5	45	111.5	58	20	8

■ Dimensions of LMFA3,4 forcers

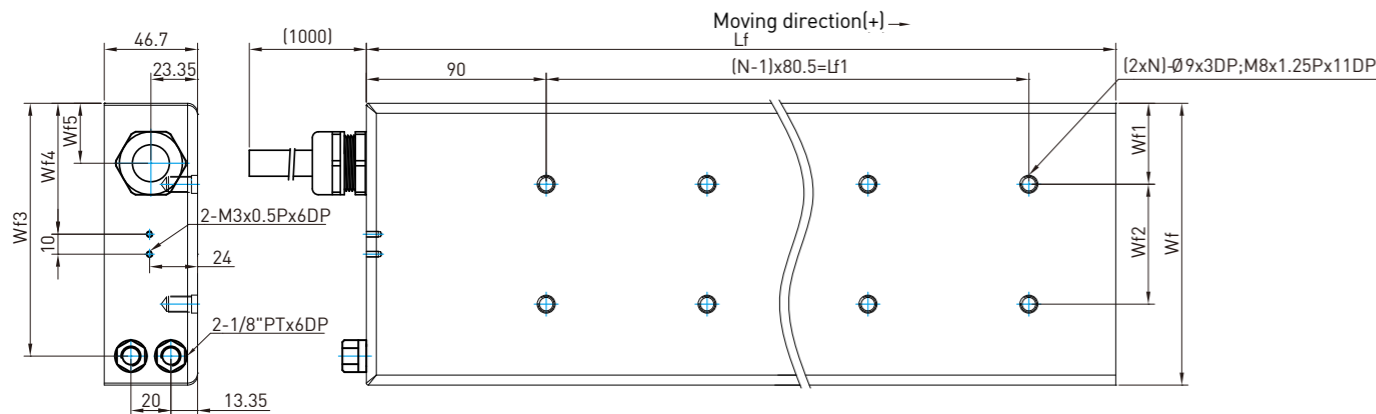

Type	Lf	Lf1	Wf	Wf1	Wf2	Wf3	Wf4	Wf5	N
LMFA31	214	80.5	141	40.5	60	126.5	65.5	30	2
LMFA32	375	241.5	141	40.5	60	126.5	65.5	30	4
LMFA33	536	402.5	141	40.5	60	126.5	65.5	30	6
LMFA34	697	563.5	141	40.5	60	126.5	65.5	30	8
LMFA41	214	80.5	188	54	80	173.5	89	30	2
LMFA42	375	241.5	188	54	80	173.5	89	30	4
LMFA43	536	402.5	188	54	80	173.5	89	30	6
LMFA44	697	563.5	188	54	80	173.5	89	30	8

■ Dimensions of LMFA5,6 forcers

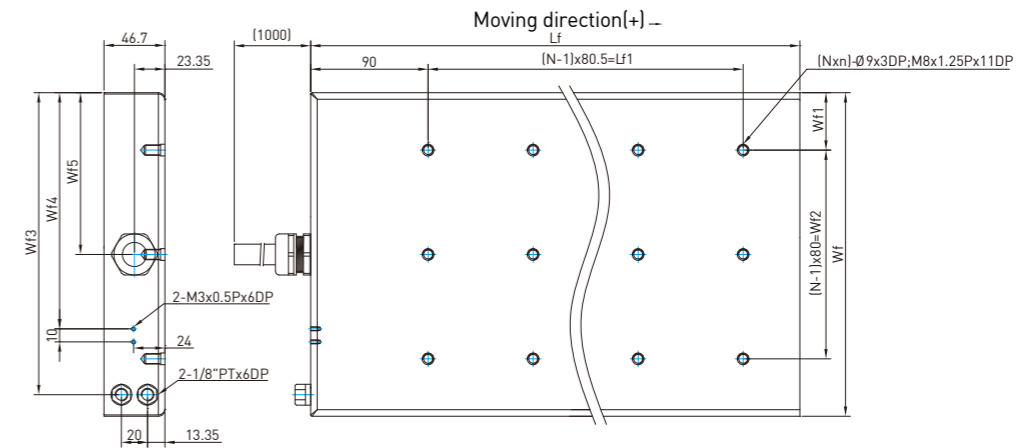

Type	Lf	Lf1	Wf	Wf1	Wf2	Wf3	Wf4	Wf5	N	n
LMFA52	375	241.5	248	44	160	231.5	181	124	3	4
LMFA53	536	402.5	248	44	160	231.5	181	124	3	6
LMFA54	697	563.5	248	44	160	231.5	181	124	3	8
LMFA62	375	241.5	342	51	240	325.5	245	171	4	4
LMFA63	536	402.5	342	51	240	325.5	245	171	4	6
LMFA64	697	563.5	342	51	240	325.5	245	171	4	8

■ Dimensions of LMFA0,1,2 stators

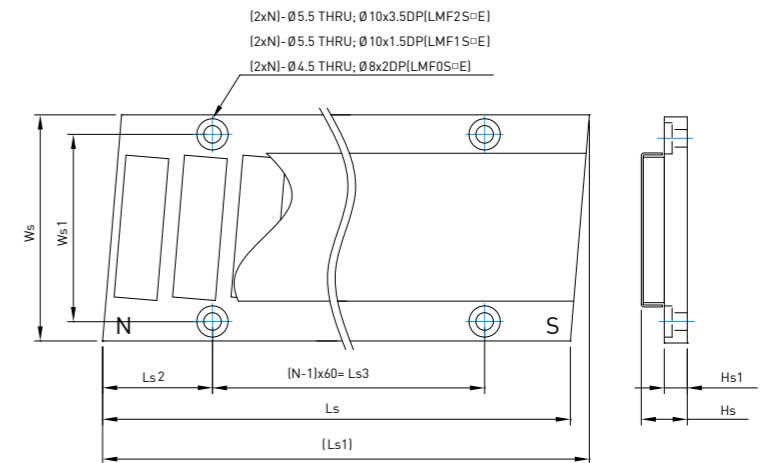

Type	Ls	Ls1	Ls2	Ls3	Hs	Hs1	Ws	Ws1	N
LMF0S1	120	124.87	31.25	60	11.8	5.9	58	48	2
LMF0S1E	120	124.87	31.25	60	11.3	5.7	58	48	2
LMF0S2	180	184.87	31.25	120	11.8	5.9	58	48	3
LMF0S2E	180	184.87	31.25	120	11.3	5.7	58	48	3
LMF0S3	300	304.87	31.25	240	11.8	5.9	58	48	5
LMF0S3E	300	304.87	31.25	240	11.3	5.7	58	48	5
LMF1S1	120	122.77	30.6	60	11.8	5.9	88	74	2
LMF1S1E	120	122.77	30.6	60	11.3	5.7	88	74	2
LMF1S2	180	182.77	30.6	120	11.8	5.9	88	74	3
LMF1S2E	180	182.77	30.6	120	11.3	5.7	88	74	3
LMF1S3	300	302.77	30.6	240	11.8	5.9	88	74	5
LMF1S3E	300	302.77	30.6	240	11.3	5.7	88	74	5
LMF2S1	120	123.09	30.4	60	13.8	7.9	118	104	2
LMF2S1E	120	123.09	30.4	60	13.3	7.7	118	104	2
LMF2S2	180	183.09	30.4	120	13.8	7.9	118	104	3
LMF2S2E	180	183.09	30.4	120	13.3	7.7	118	104	3
LMF2S3	300	303.09	30.4	240	13.8	7.9	118	104	5
LMF2S3E	300	303.09	30.4	240	13.3	7.7	118	104	5

■ Dimensions of LMFA3,4 stators

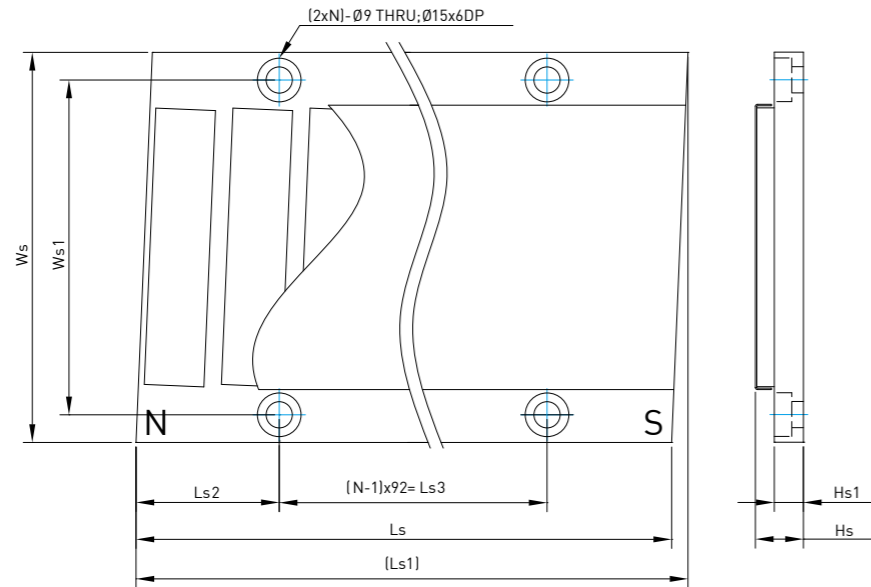

Type	L_s	L_{s1}	L_{s2}	L_{s3}	H_s	H_{s1}	W_s	W_{s1}	N
LMF3S1	184	189.62	49.2	92	16.5	10	134	115	2
LMF3S1E	184	189.62	49.2	92	16	9.8	134	115	2
LMF3S2	276	281.62	49.2	184	16.5	10	134	115	3
LMF3S2E	276	281.62	49.2	184	16	9.8	134	115	3
LMF3S3	460	465.62	49.2	368	16.5	10	134	115	5
LMF3S3E	460	465.62	49.2	368	16	9.8	134	115	5
LMF4S1	184	189.03	48.9	92	18.5	12	180	161	2
LMF4S1E	184	189.03	48.9	92	18	11.8	180	161	2
LMF4S2	276	281.03	48.9	184	18.5	12	180	161	3
LMF4S2E	276	281.03	48.9	184	18	11.8	180	161	3
LMF4S3	460	465.03	48.9	368	18.5	12	180	161	5
LMF4S3E	460	465.03	48.9	368	18	11.8	180	161	5

■ Dimensions of LMFA5,6 stators

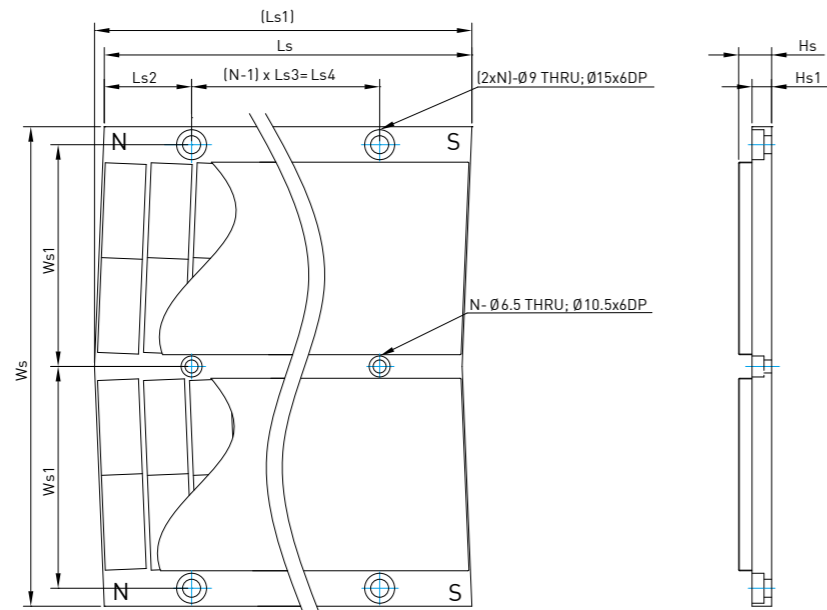

Type	L_s	L_{s1}	L_{s2}	L_{s3}	L_{s4}	H_s	H_{s1}	W_s	W_{s1}	N
LMF5S1E	184	188.89	43.7	92	92	16	9.8	240	111	2
LMF5S2E	276	280.89	43.7	92	184	16	9.8	240	111	3
LMF5S3E	460	464.89	43.7	92	368	16	9.8	240	111	5
LMF6S1E	184	188.66	20.97	46	138	18	11.8	334	158	4

■ Mounting tolerances

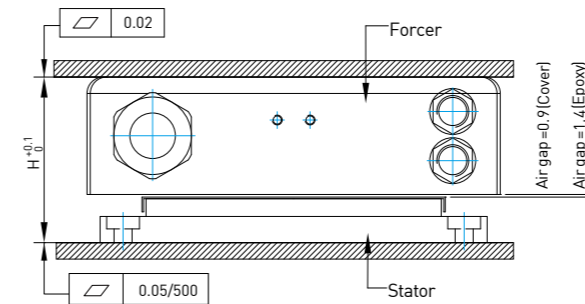

Type	H	Type	H
LMFA01	48.5	LMFA31	64.1
LMFA02	48.5	LMFA32	64.1
LMFA03	48.5	LMFA33	64.1
LMFA11	48.5	LMFA34	64.1
LMFA12	48.5	LMFA41	66.1
LMFA13	48.5	LMFA42	66.1
LMFA14	48.5	LMFA43	66.1
LMFA21	50.5	LMFA44	66.1
LMFA22	50.5	LMFA52	64.1
LMFA23	50.5	LMFA53	64.1
LMFA24	50.5	LMFA54	64.1
		LMFA62	66.1
		LMFA63	66.1
		LMFA64	66.1

2.2.3 Order code of primary part (forcer)

Series	Type	Width of forcer	Length of forcer	Winding code
LM	FA	3	1	L
Linear motor	Linear motor type	0: 67mm 1: 96mm 2: 126mm 3: 141mm 4: 188mm 5: 248mm 6: 342mm	LMFA 0-2 series 1: 145 mm 2: 250 mm 3: 355 mm 4: 460 mm LMFA 3-6 series 1: 214 mm 2: 375 mm 3: 563 mm 4: 697 mm	None: Standard L: Low back EMF

2.2.4 Order code of magnet track (stator)

Series	Width of stator	Model	Length of stator	Magnet package
LMF	0	S	1	E
	0: 58 mm 1: 88 mm 2: 118 mm 3: 134 mm 4: 180 mm 5: 240 mm 6: 334 mm	S: Standard C: Customize	LMF0-2 series 1: 120 mm 2: 180 mm 3: 300 mm LMF3-6 series 1: 184 mm 2: 276 mm 3: 460 mm	E: Epoxy None: Cover plate

2.3 LMSC series Linear motor

The HIWIN LMSC synchronous linear motors are core-type, with the same characteristic as the LMS series but have about 2 times the thrust. Because forcers are arranged in a special way between two stators, attraction of forcers and stators will be offset. Load on slide rail is greatly reduced, and relatively high thrust density can be achieved in a very small volume.

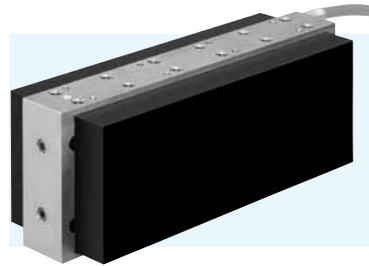

- Magnetic force is offset
- Rails are not pre-stressed by magnetic attraction
- Can be water-cooled
- Continuous force range from 1070N to 1819N
- Peak force 2140N
- Installation height 131.5mm

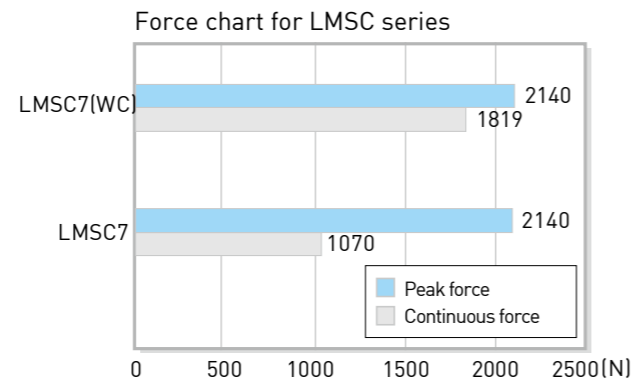

2.3.1 LMSC series F-V curves

■ Force and velocity curve(DC bus voltage = 325 V_{DC})

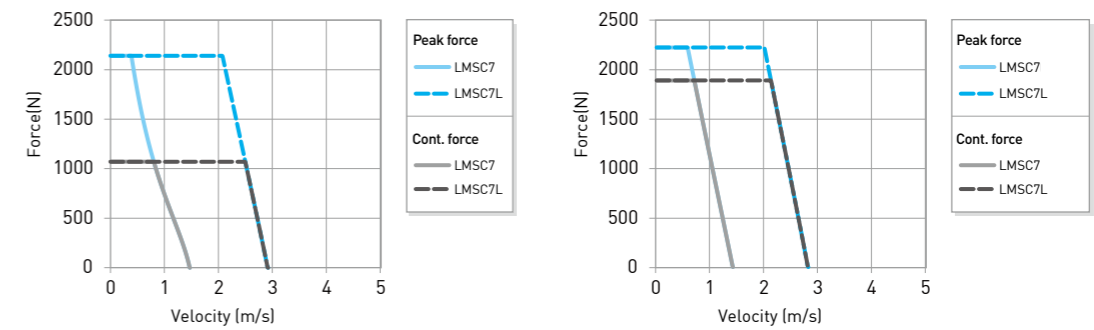

■ Force and velocity curve(DC bus voltage = 600 V_{DC})

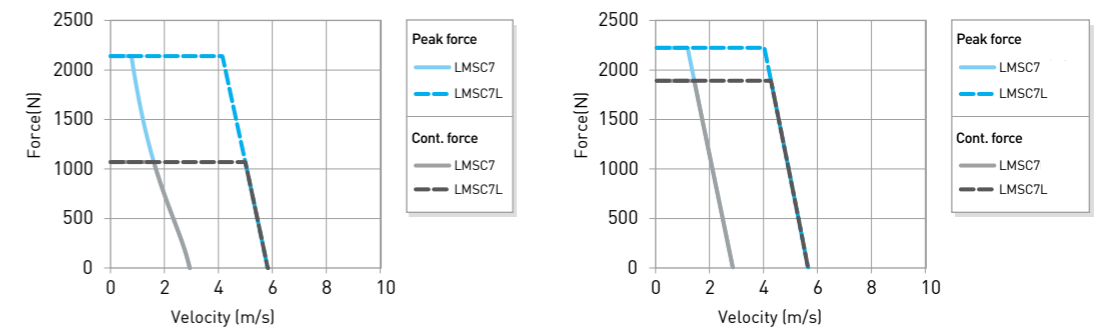

Table 2-3 LMSC series specifications

	Symbol	Unit	LMSC7	LMSC7(WC)	LMSC7L	LMSC7L(WC)
Continuous force	F_c	N	1070	1819	1070	1819
Continuous current	I_c	A _{rms}	3.9	6.7	7.9	13.4
Peak force (1s)	F_p	N	2140			
Peak current (1s)	I_p	A _{rms}	11.8	11.8	23.7	23.7
Force constant	K_f	N/A _{rms}	271	271	136	136
Attraction force	F_a	N	0			
Maximum winding tempature	T_{max}	°C	120			
Electrical time constant	K_e	ms	10.5	10.5	10.0	10.0
Resistance (line to line · 25°C)	R_{25}	Ω	17.8	17.8	4.2	4.2
Resistance (line to line · 120°C)	R_{120}	Ω	23.5	23.5	5.5	5.5
Inductance (line to line)	L	mH	206.8	206.8	46.2	46.2
Pole pair pitch	2τ	mm	32			
Minimum bending radius of cable	R_{bend}	mm	45(500V)/69(600V)			
Back emf constant (line to line)	K_v	V _{rms} /(m/s)	141	141	71	71
Motor constant(25°C)	K_m	N/√W	52.4	52.4	54.2	54.2
Thermal resistance	R_{TH}	°C/W	0.17	0.06	0.18	0.06
Thermal switch	-	-	3 PTC SNM120 In Series			
Maximum DC bus voltage	-	V _{DC}	600			
Mass of forcer	M_f	kg	14			
Unit mass of stator	M_s	kg/m	16.4			
Width of stator	W_s	mm	100			
Length of stator/Dimension N	L_s	mm	128mm/N=1, 192mm/N=2, 320mm/N=4			
Stator mounting distance	W_{s1}	mm	85			
Total installation height	H	mm	131.5			

Note: 1. WC-water cooling.
2. Except to dimensions, the electrical specifications are in ±10% of tolerance.
3. We reserve the right to change, please follow customer recognition drawings.

2.3.2 LMSC series forcers and stators dimensions

■ Dimensions of LMSC7 forcer

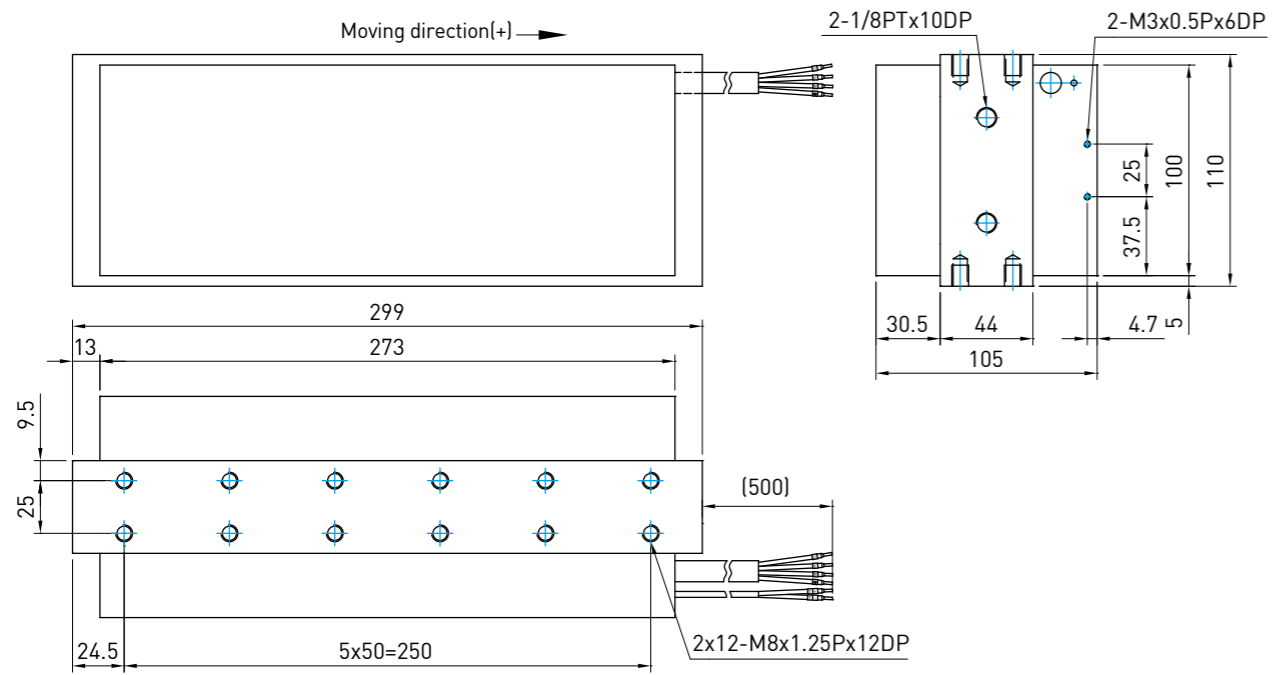

■ Mounting tolerances

■ Dimensions of LMSC7 stator

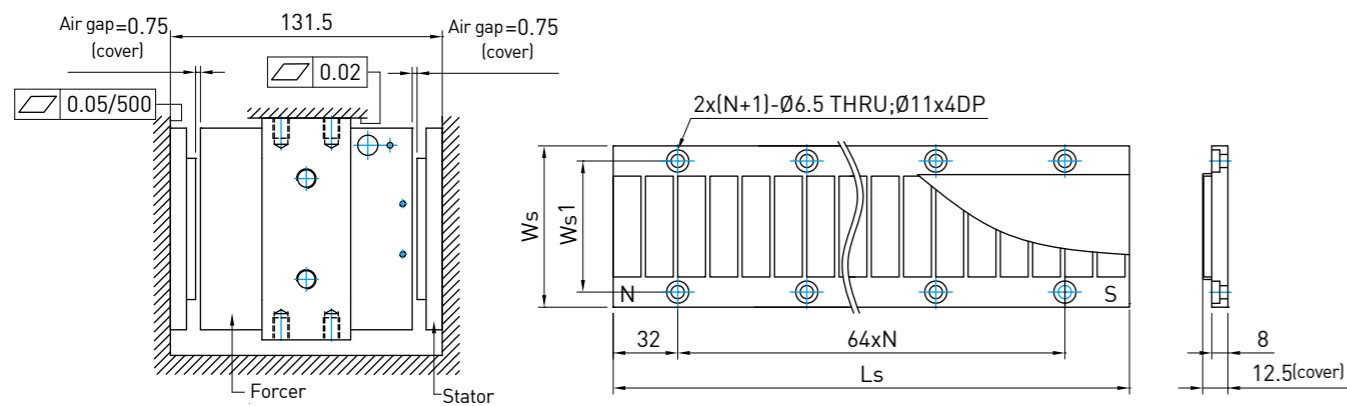

2.4 LMC series Linear motor

The HIWIN LMC coreless U-shaped linear motor has no cogging, an excellent low velocity ripple and excellent dynamic characteristics. With no attraction between forcers and stators and a very low-profile structure, the motor can be applied to the installation platform without deformation and has a light load demand for continuous movement curve. For example: high-speed, light-load automation equipment, dust-free environment automation equipment, flat panel equipment, optical detection equipment, scanning electron microscope equipment, semiconductor equipment.

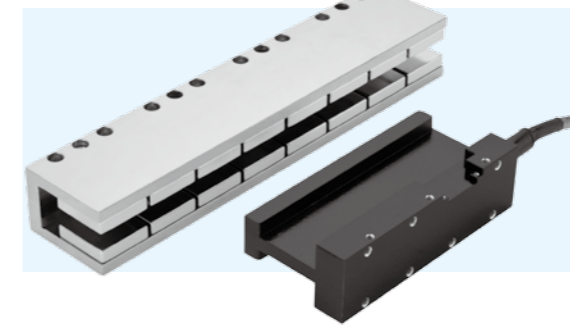

- Three-phase
- Excellent dynamic characteristics
- Excellent synchronization and high speed coordination
- Small inertia, high acceleration
- Low installation height
- No cogging
- No attraction between force
- Same movement axis can use with multiple forcers

Force chart for LMC series

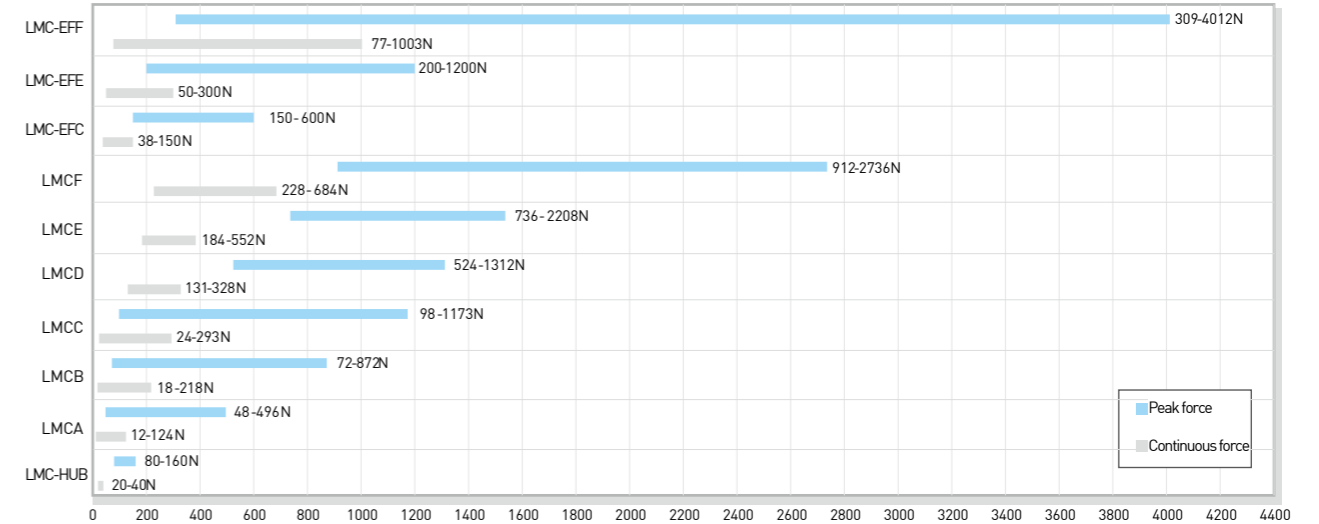

2.4.1 LMCA series

Table 2-4 LMCA series specifications

	Symbol	Unit	LMCA1	LMCA2	LMCA3	LMCA4	LMCA5	LMCA6	LMCA7	LMCA8	LMCAA	LMCAC
Continuous force	F_c	N	12	24	34	45	52	62	72	83	96	124
Continuous current	I_c	A_{rms}	2.2	2.3	2.1	2.1	1.8	1.8	1.8	1.8	1.8	1.8
Peak force (1s)	F_p	N	48	96	136	180	208	248	289	331	386	496
Peak current (1s)	I_p	A_{rms}	8.8	9.2	8.4	8.4	7.2	7.2	7.2	7.2	7.2	7.2
Force constant	K_f	N/A_{rms}	5.3	10.6	15.8	21.2	28.2	33.8	39.4	45	53	68
Maximum winding temperature	T_{max}	$^{\circ}C$	100									
Electrical time constant	K_e	ms	0.4	0.4	0.3	0.3	0.3	0.3	0.3	0.3	0.3	0.3
Resistance (line to line, 25 $^{\circ}C$)	R_{25}	Ω	1.4	2.7	4.1	5.4	6.7	8.2	9.6	11	13	16
Inductance (line to line)	L	mH	0.5	1.0	1.4	1.9	2.3	2.8	3.3	3.7	4.7	5.6
Pole pair pitch	2τ	mm	32									
Minimum bending radius of cable	R_{bend}	mm	37.5									
Back emf constant (line to line)	K_v	$V_{rms}/(m/s)$	3.0	5.9	8.8	11.9	14.5	17.4	20.3	23.2	27.1	34.8
Motor constant(25 $^{\circ}C$)	K_m	N/\sqrt{W}	3.8	5.2	6.5	7.5	9.1	9.8	10.6	11.3	12.2	13.9
Thermal resistance	R_{TH}	$^{\circ}C/W$	6.11	2.80	2.21	1.68	1.84	1.50	1.29	1.13	0.97	0.75
Thermal switch			PTC									
Maximum DC bus voltage	V_{DC}		330									
Mass of forcer	M_f	kg	0.08	0.15	0.23	0.31	0.38	0.45	0.72	0.88	0.74	0.76
Unit mass of stator	M_s	kg/m	7									
Length of forcer/dimension n	L_f	mm	34	66/2	98/3	130/4	162/5	194/6	226/7	258/8	322/10	386/12
Length of stator/dimension N	L_s	mm	128mm/N=2, 192mm/N=3, 320mm/N=5									

Note: 1. Values in this table are motor at 25 $^{\circ}C$ ambient temperature and no forced cooling.
 2. Except dimensions, the electrical specifications are in $\pm 10\%$ of tolerance.
 3. We reserve the right of changes, please follow customer recognition drawings.

Force and velocity curve (DC bus voltage = 330 V_{DC})

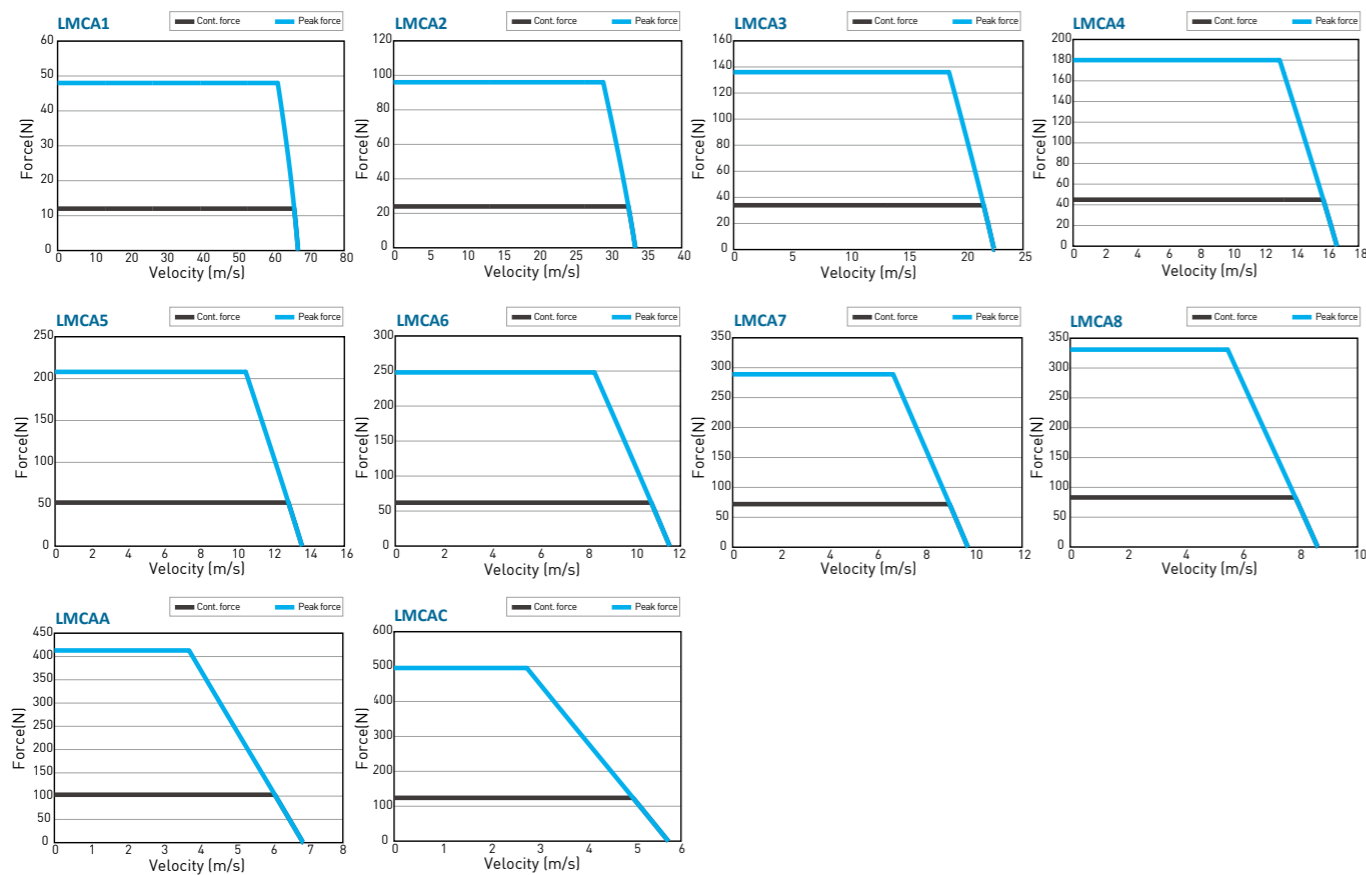

LMCA series forcers and stators dimensions

Dimensions of LMCA forcers

(Value for L_f and n : see Table2-4)

LMCA1:

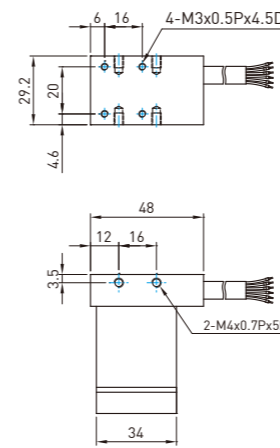

LMCA2-LMCAc

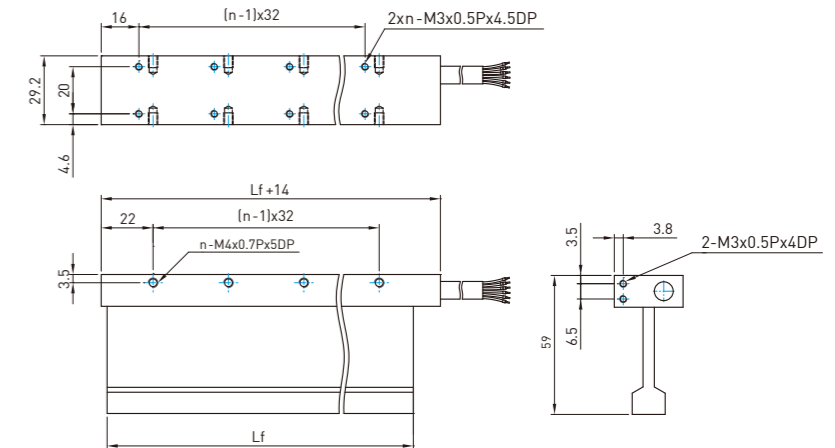

Dimensions of LMCA stators

(Value for L_s and N : see Table2-4)

Mounting tolerances

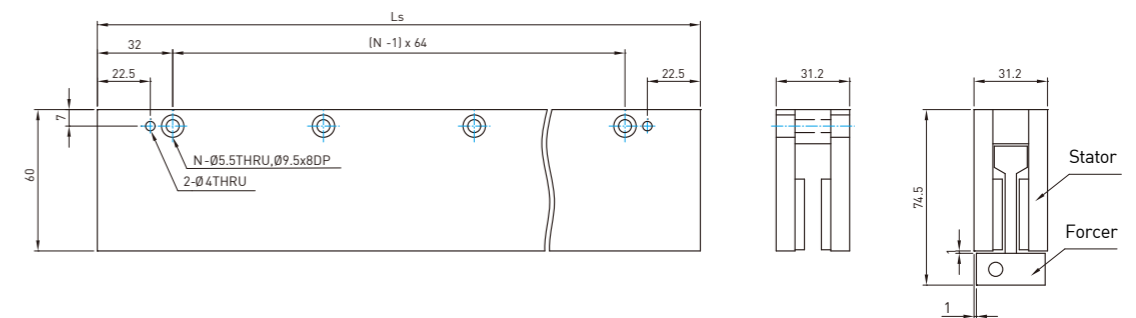

Order code of magnet track (stator)

Series	Height of stator	Model	Length of stator
LMC	A	S	3
	A: 60mm	S: Standard	0:128mm 1:192mm 3:320mm

2.4.2 LMCB series

Table 2-5 LMCB series specifications

	Symbol	Unit	LMCB1	LMCB2	LMCB3	LMCB4	LMCB5	LMCB6	LMCB7	LMCB8	LMCBA	LMCBC
Continuous force	F_c	N	18	36	54	73	91	109	128	145	181	216
Continuous current	I_c	A_{rms}	2.0	2.0	2.0	2.0	2.0	2.0	2.0	2.0	2.0	1.8
Peak force (1s)	F_p	N	72	144	216	292	364	436	512	580	724	864
Peak current (1s)	I_p	A_{rms}	8.0	8.0	8.0	8.0	8.0	8.0	8.0	8.0	8.0	7.2
Force constant	K_f	N/A_{rms}	9.1	18.1	27.2	36.3	45.4	54.5	63.5	72.5	90.6	109.0
Maximum winding temperature	T_{max}	$^{\circ}C$	100									
Electrical time constant	K_e	ms	0.4	0.4	0.4	0.4	0.4	0.4	0.3	0.3	0.3	0.4
Resistance (line to line, 25 $^{\circ}C$)	R_{25}	Ω	1.8	3.6	5.4	7.1	9.0	10.7	12.6	14.6	17.9	21.0
Inductance (line to line)	L	mH	0.7	1.4	1.9	2.6	3.2	3.8	4.4	5.0	6.2	8.0
Pole pair pitch	2τ	mm	32									
Minimum bending radius of cable	R_{bend}	mm	37.5									
Back emf constant (line to line)	K_v	$V_{rms}/(m/s)$	5.1	10.1	15.2	20.0	24.8	29.3	34.7	40.0	50.0	59.0
Motor constant(25 $^{\circ}C$)	K_m	N/\sqrt{W}	5.5	7.7	9.5	11.2	12.4	13.6	14.7	15.5	17.5	21.4
Thermal resistance	R_{TH}	$^{\circ}C/W$	5.55	2.77	1.85	1.41	1.11	0.93	0.79	0.68	0.56	0.58
Thermal switch			PTC									
Maximum DC bus voltage	V_{DC}		330									
Mass of forcer	M_f	kg	0.10	0.20	0.29	0.38	0.48	0.58	0.68	0.72	0.88	1.16
Unit mass of stator	M_s	kg/m	12									
Length of forcer/dimension n	L_f	mm	34	66/2	98/3	130/4	162/5	194/6	226/7	258/8	322/10	386/12
Length of stator/dimension N	L_s	mm	128mm/N=2, 192mm/N=3, 320mm/N=5									

Note: 1. Values in this table are motor at 25 $^{\circ}C$ ambient temperature and no forced cooling.
 2. Except diemensions, the electrical specifications are in $\pm 10\%$ of tolerance.
 3. We reserve the right of changes, please follow customer recognition drawings.

Force and velocity curve (DC bus voltage = 330 V_{DC})

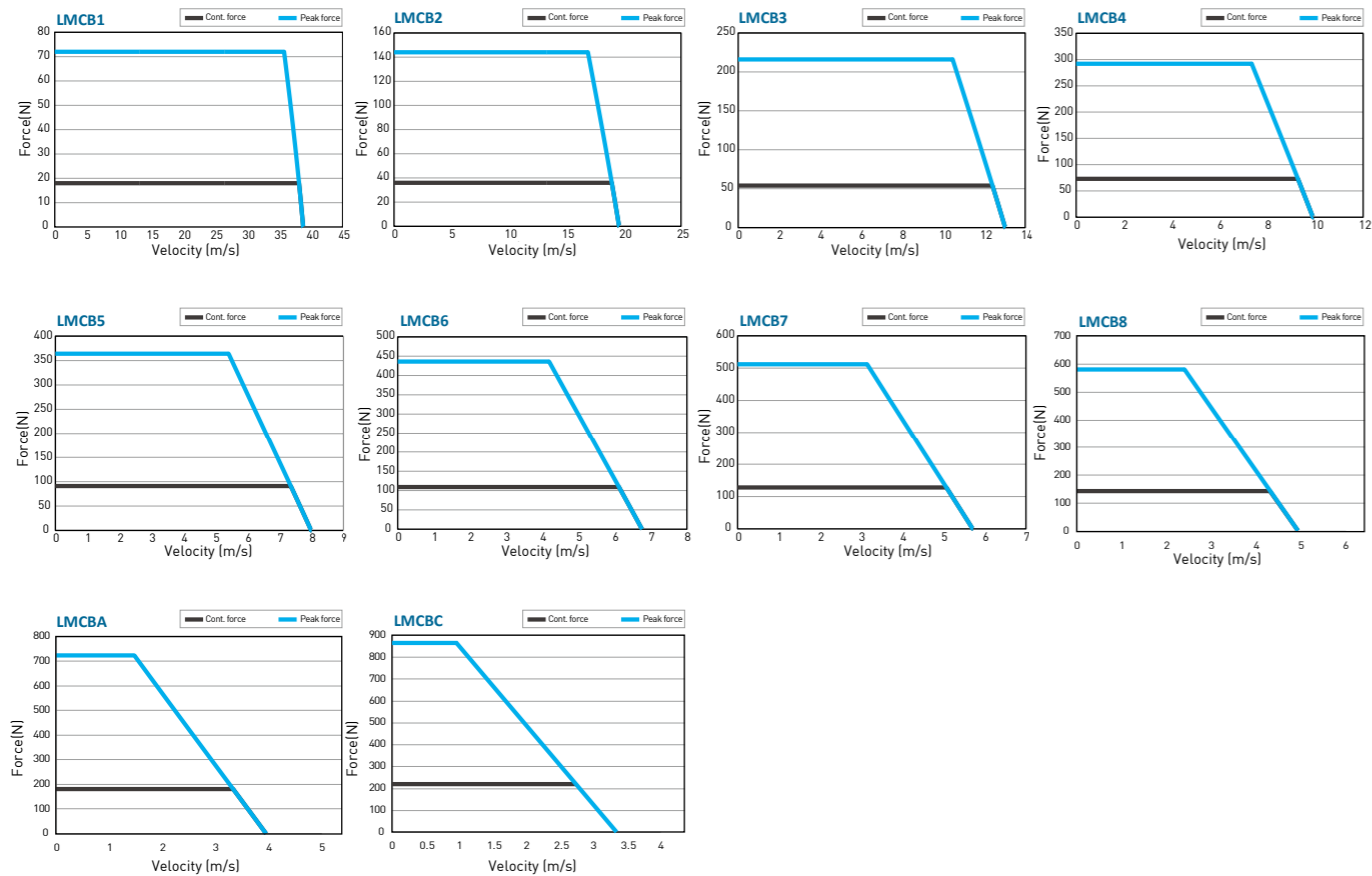

LMCB series forcers and stators dimensions

Dimensions of LMCB forcers

(Value for L_f and n : see Table2-5)

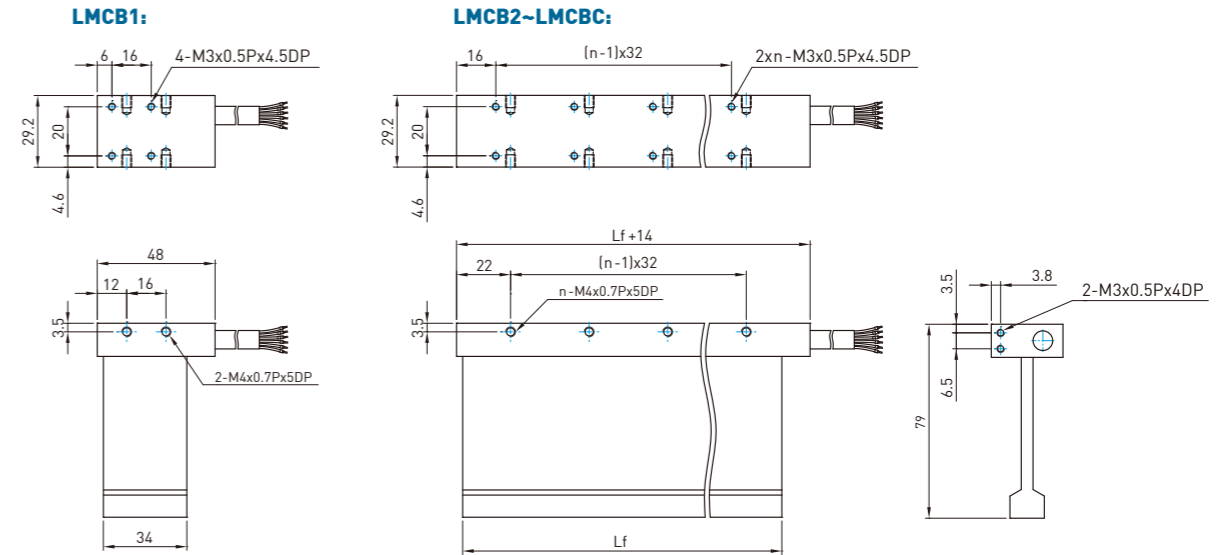

Dimensions of LMCB stators

(Value for L_s and N : see Table2-5)

Mounting tolerances

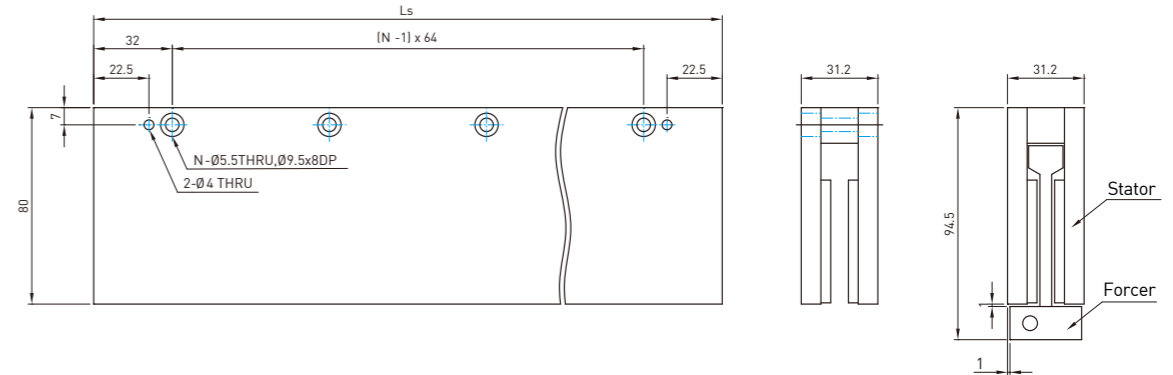

Order code of magnet track (stator)

Series	Height of stator	Model	Length of stator
LMC	B	S	3
	B: 80mm	S: Standard	0: 128mm 1: 192mm 3: 320mm

2.4.3 LMCC series

Table 2-6 LMCC series specifications

	Symbol	Unit	LMCC1	LMCC2	LMCC3	LMCC4	LMCC5	LMCC6	LMCC7	LMCC8	LMCCA	LMCCC
Continuous force	F_c	N	24	49	73	98	122	147	171	195	244	293
Continuous current	I_c	A_{rms}	2.0									
Peak force (1s)	F_p	N	98	195	293	391	489	586	684	780	977	1173
Peak current (1s)	I_p	A_{rms}	8.0									
Force constant	K_f	N/A_{rms}	12.2	24.4	36.6	48.8	61.0	73.2	85.4	97.5	122.0	146.4
Maximum winding temperature	T_{max}	$^{\circ}C$	100									
Electrical time constant	K_e	ms	0.3									
Resistance (line to line, 25 $^{\circ}C$)	R_{25}	Ω	2.3	4.5	6.8	9.0	11.3	13.5	15.8	18.2	22.6	27.1
Inductance (line to line)	L	mH	0.8	1.6	2.4	3.1	3.9	4.7	5.5	6.3	7.9	9.4
Pole pair pitch	2τ	mm	32									
Minimum bending radius of cable	R_{bend}	mm	37.5									
Back emf constant (line to line)	K_v	$V_{rms}/(m/s)$	6.5	13.0	19.5	25.9	32.4	38.9	45.4	51.9	64.9	77.8
Motor constant(25 $^{\circ}C$)	K_m	N/\sqrt{W}	6.6	9.4	11.5	13.3	14.8	16.3	17.6	18.7	21.0	23.0
Thermal resistance	R_{Th}	$^{\circ}C/W$	4.42	2.21	1.47	1.11	0.88	0.74	0.63	0.55	0.44	0.37
Thermal switch			PTC									
Maximum DC bus voltage	V_{DC}		330									
Mass of forcer	M_f	kg	0.11	0.21	0.32	0.42	0.53	0.63	0.74	0.76	1.06	1.27
Unit mass of stator	M_s	kg/m	21									
Length of forcer/dimension n	L_f	mm	34	66/2	98/3	130/4	162/5	194/6	226/7	258/8	322/10	386/12
Length of stator/dimension N	L_s	mm	128mm/N=2, 192mm/N=3, 320mm/N=5									

Note: 1. Values in this table are motor at 25 $^{\circ}C$ ambient temperature and no forced cooling.
 2. Except dimensions, the electrical specifications are in $\pm 10\%$ of tolerance.
 3. We reserve the right of changes, please follow customer recognition drawings.

Force and velocity curve (DC bus voltage = 330 V_{DC})

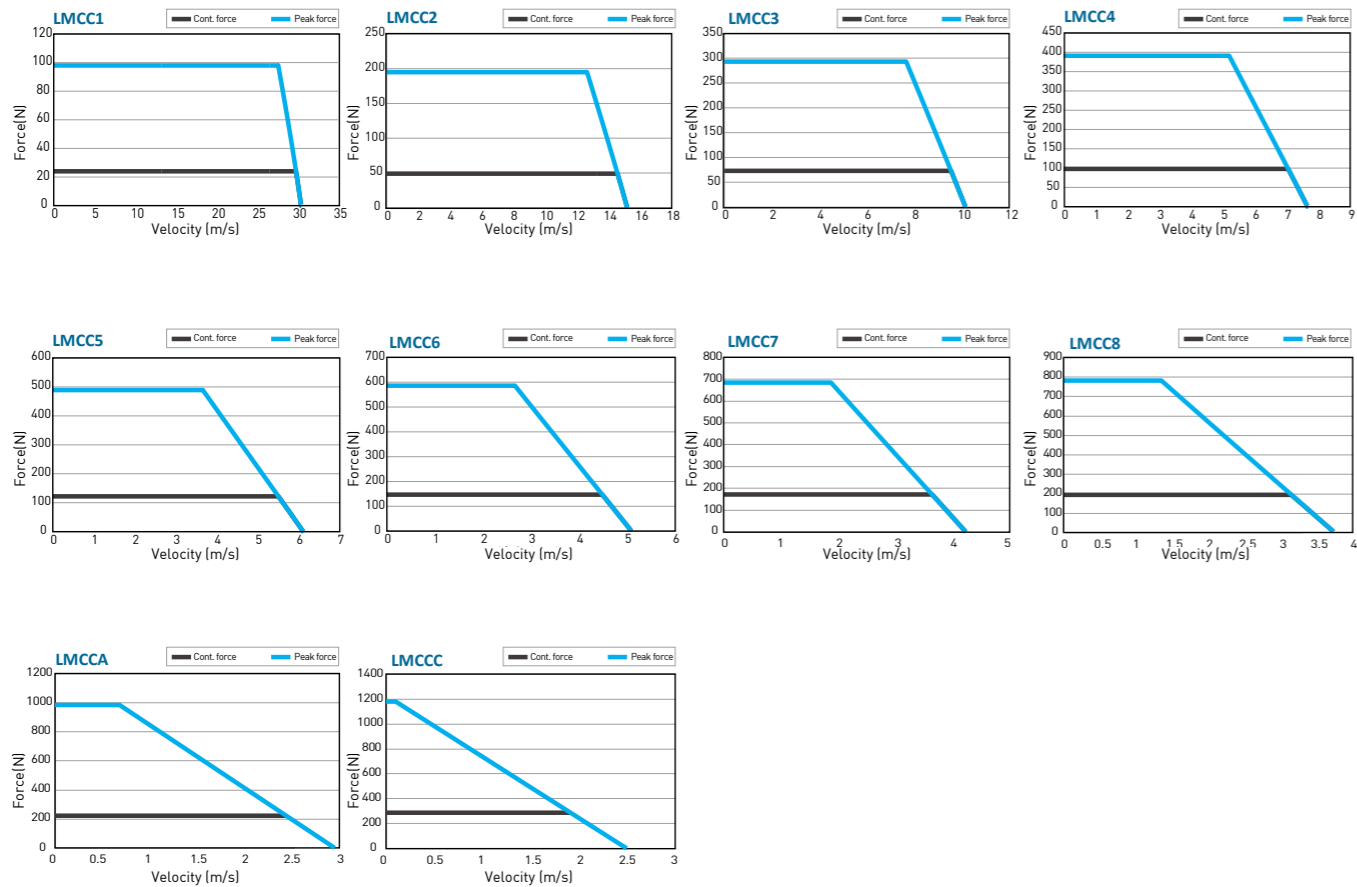

LMCC series forcers and stators dimensions

Dimensions of LMCC forcers

(Value for L_f and n : see Table2-6)

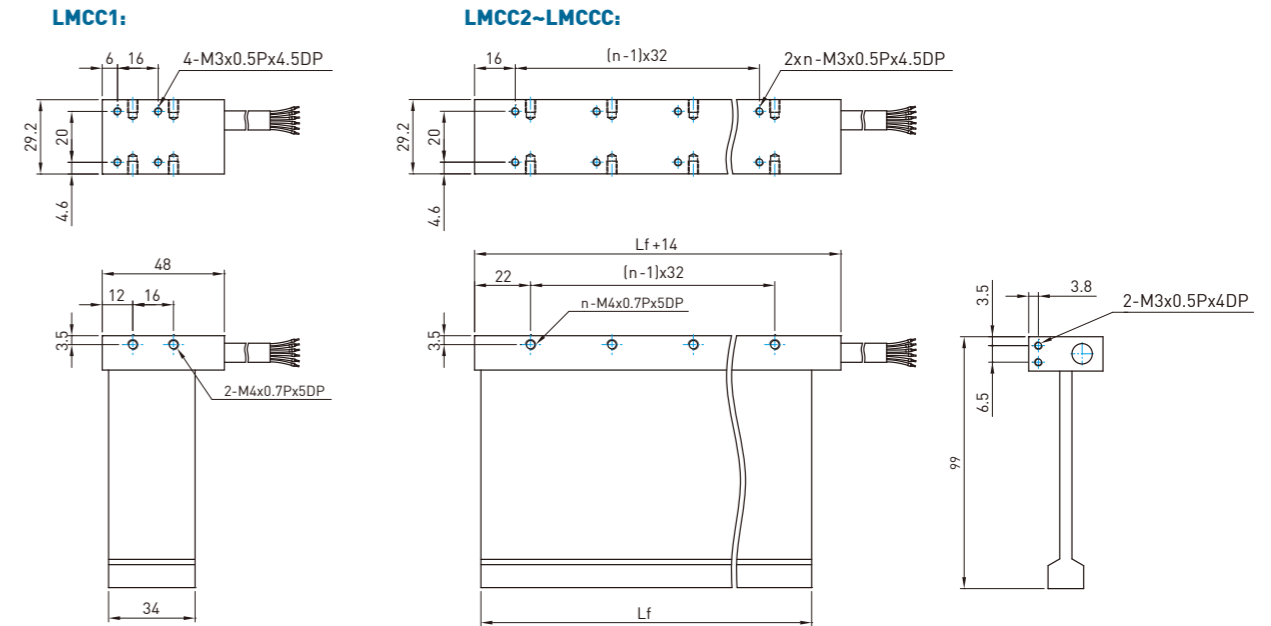

Dimensions of LMCC stators

(Value for L_s and N : see Table2-6)

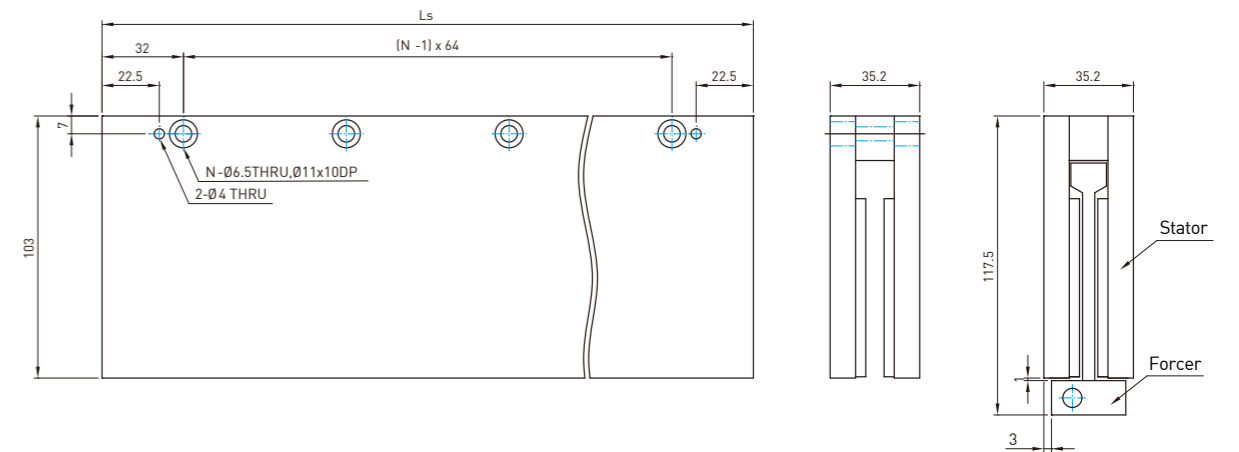

Mounting tolerances

Order code of magnet track (stator)

Series	Height of stator	Model	Length of stator
LMC	C	S	3
	C:103mm	S: Standard	0:128mm 1:192mm 3:320mm

2.4.4 LMCD series

Table 2-7 LMCD series specifications

	Symbol	Unit	LMCD4	LMCD6	LMCD8	LMCDA
Continuous force	F_c	N	131	197	262	328
Continuous current	I_c	A_{rms}			3.25	
Peak force (1s)	F_p	N	524	788	1048	1312
Peak current (1s)	I_p	A_{rms}			13	
Force constant	K_f	N/A_{rms}	40.3	60.6	80.6	100.9
Maximum winding temperature	T_{max}	$^{\circ}C$			100	
Electrical time constant	K_e	ms			0.5	
Resistance (line to line, 25 $^{\circ}C$)	R_{25}	Ω	4.6	7.1	9	11.6
Inductance (line to line)	L	mH	2.3	3.5	4.7	5.8
Pole pair pitch	2τ	mm			60	
Minimum bending radius of cable	R_{bend}	mm			37.5	
Back emf constant (line to line)	K_v	$V_{rms}/(m/s)$	25	38	50	63
Motor constant(25 $^{\circ}C$)	K_m	N/\sqrt{W}	14.6	17.8	20	22.2
Thermal resistance	R_{TH}	$^{\circ}C/W$	0.82	0.53	0.42	0.33
Thermal switch					PTC	
Maximum DC bus voltage		V_{DC}			330	
Mass of forcer	M_f	kg	0.88	1.32	1.76	2.20
Unit mass of stator	M_s	kg/m			16	
Length of forcer/dimension n	L_f	mm	260/7	380/10	500/13	620/16
Length of stator/dimension N	L_s	mm		120mm/N=2, 180mm/N=3, 300mm/N=5		

Note: 1. Values in this table are motor at 25 $^{\circ}C$ ambient temperature and no forced cooling.
 2. Except diemensions, the electrical specifications are in $\pm 10\%$ of tolerance.
 3. We reserve the right of changes, please follow customer recognition drawings.

Force and velocity curve(DC bus voltage = 330 V_{DC})

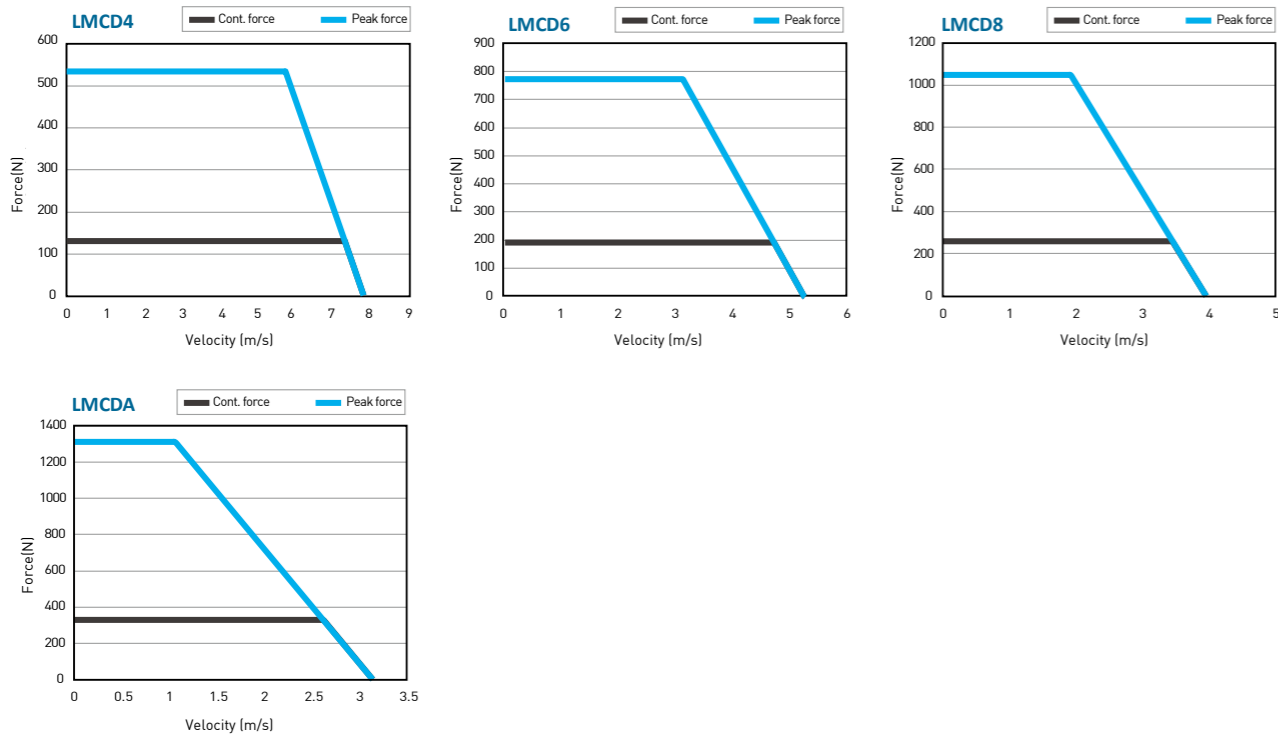

LMCD series forcers and stators dimensions

Dimensions of LMCD forcers

(Value for L_f and n : see Table2-7)

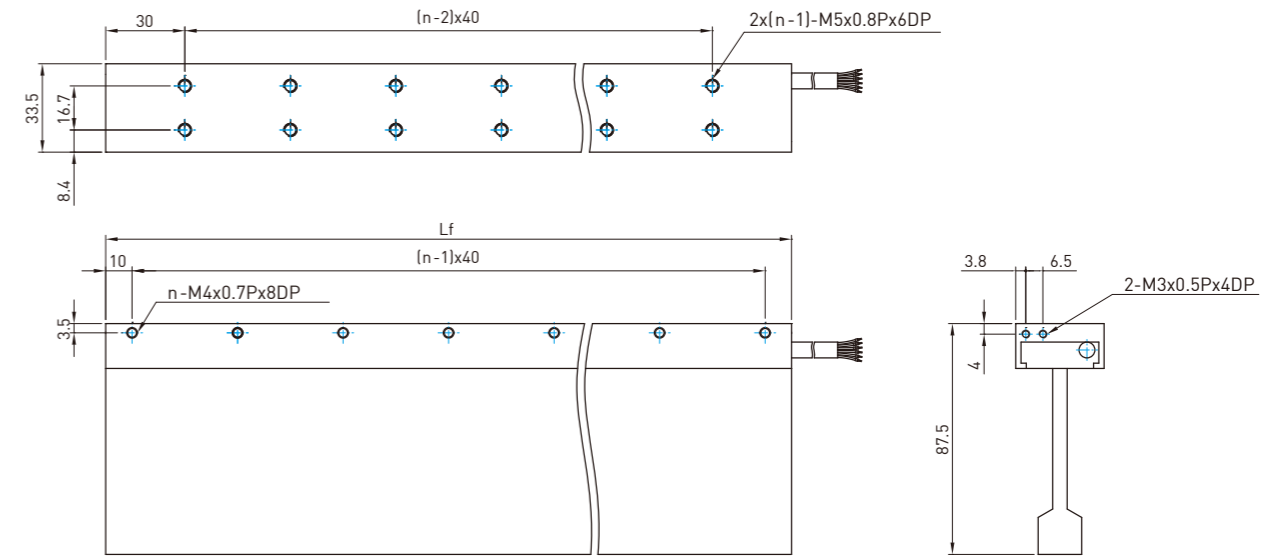

Dimensions of LMCD stators

(Value for L_s and N : see Table2-7)

Mounting tolerances

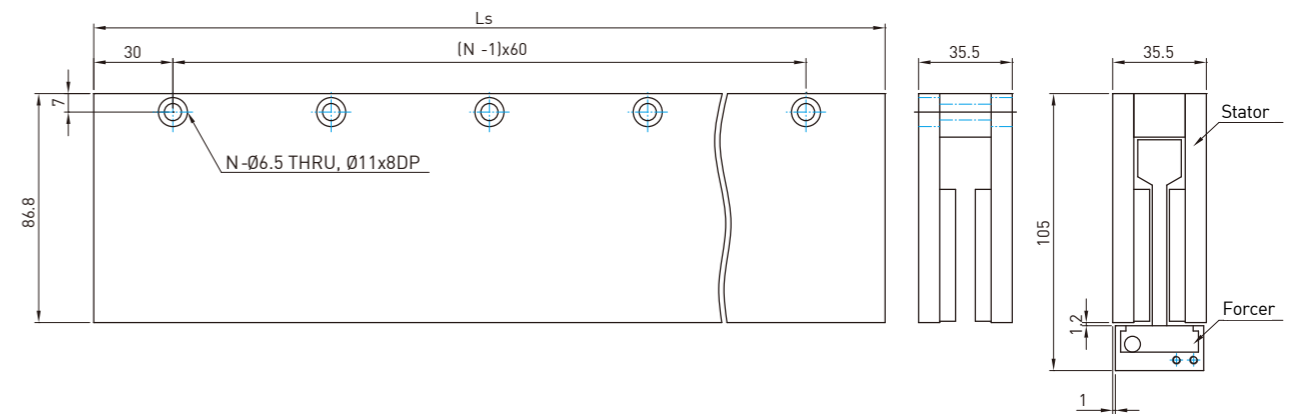

Order code of magnet track (stator)

Series	Height of stator	Model	Length of stator
LMC	D	S	1
	D:86.8mm	S: Standard	1:120mm B:180mm 2:300mm

2.4.5 LMCE series

Table 2-8 LMCE series specifications

	Symbol	Unit	LMCE4	LMCE6	LMCE8	LMCEA	LMCEC
Continuous force	F_c	N	184	276	368	460	552
Continuous current	I_c	A_{rms}					3.25
Peak force (1s)	F_p	N	736	1104	1472	1840	2208
Peak current (1s)	I_p	A_{rms}					13
Force constant	K_f	N/A_{rms}	56.6	84.9	113.2	141.5	169.8
Maximum winding temperature	T_{max}	$^{\circ}C$					100
Electrical time constant	K_e	ms					0.5
Resistance (line to line, 25 $^{\circ}C$)	R_{25}	Ω	5.6	8.4	11.0	13.8	16.7
Inductance (line to line)	L	mH	2.9	4.4	5.9	7.3	8.8
Pole pair pitch	2τ	mm					60
Minimum bending radius of cable	R_{bend}	mm					37.5
Back emf constant (line to line)	K_v	$V_{rms}/(m/s)$	35	53	70	88	106
Motor constant(25 $^{\circ}C$)	K_m	N/\sqrt{W}	19.1	23.4	27.0	30.2	33.2
Thermal resistance	R_{TH}	$^{\circ}C/W$	0.68	0.45	0.34	0.27	0.23
Thermal switch							PTC
Maximum DC bus voltage	V_{DC}						330
Mass of forcer	M_f	kg	1.23	1.84	2.46	3.08	3.70
Unit mass of stator	M_s	kg/m					20
Length of forcer/dimension n	L_f	mm	260/7	380/10	500/13	620/16	740/19
Length of stator/dimension N	L_s	mm					120mm/N=2, 180mm/N=3, 300mm/N=5

Note: 1. Values in this table are motor at 25 $^{\circ}C$ ambient temperature and no forced cooling.
 2. Except dimensions, the electrical specifications are in $\pm 10\%$ of tolerance.
 3. We reserve the right of changes, please follow customer recognition drawings.

Force and velocity curve(DC bus voltage = 330 V_{DC})

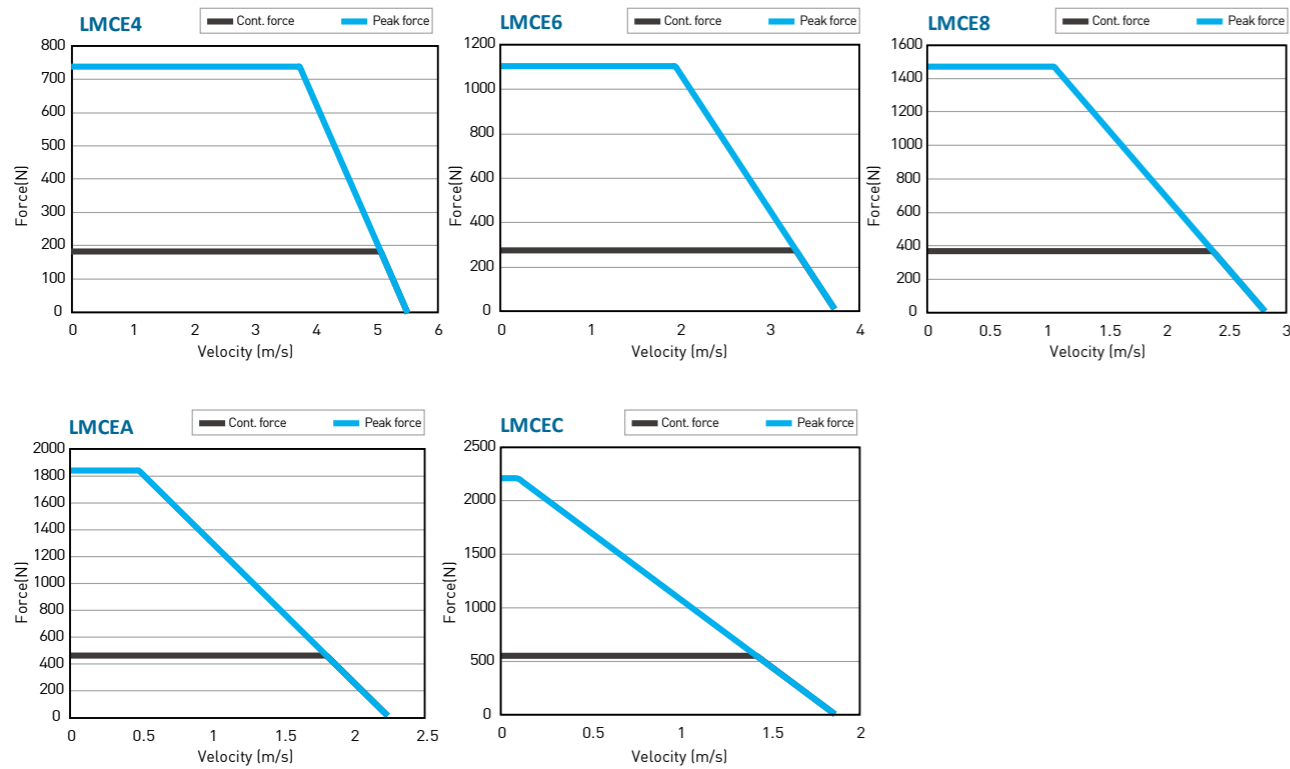

LMCE series forcers and stators dimensions

Dimensions of LMCE forcers

(Value for L_f and n : see Table2-8)

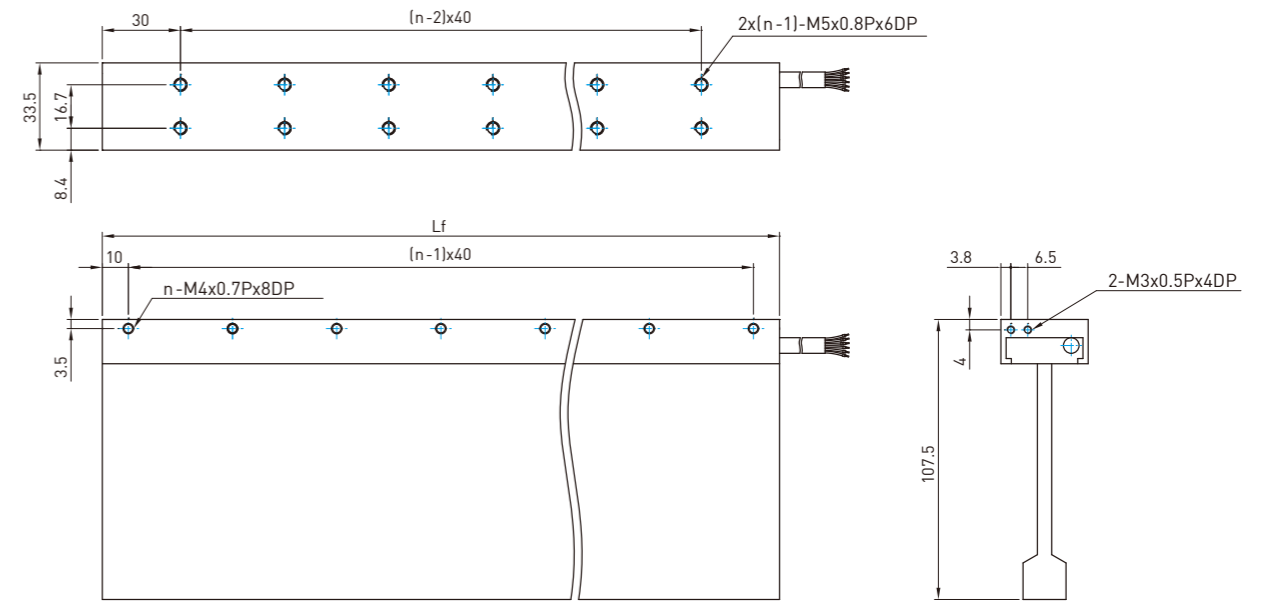

Dimensions of LMCE stators

(Value for L_s and N : see Table2-8)

Mounting tolerances

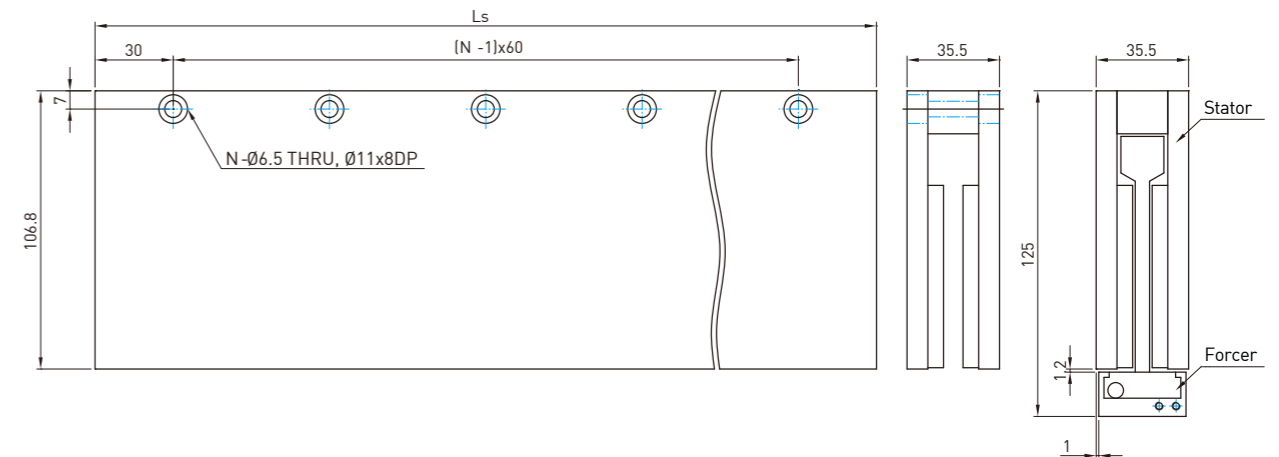

Order code of magnet track (stator)

Series	Height of stator	Model	Length of stator
LMC	E	S	1
	E:106.8mm	S: Standard	1:120mm B:180mm 2:300mm

2.4.6 LMCF series

Table 2-9 LMCF series specifications

	Symbol	Unit	LMCF4	LMCF6	LMCF8	LMCFA	LMCFC	
Continuous force	F_c	N	228	342	456	570	684	
Continuous current	I_c	A_{rms}	3.8	5.7	7.6	9.5	11.4	
Peak force (1s)	F_p	N	912	1368	1824	2280	2736	
Peak current (1s)	I_p	A_{rms}	15.2	22.8	30.4	38.0	45.6	
Force constant	K_v	N/A_{rms}						60
Maximum winding temperature	T_{max}	°C						100
Electrical time constant	K_e	ms						1
Resistance (line to line, 25°C)	R_{25}	Ω	3.3	2.2	1.7	1.3	1.1	
Inductance (line to line)	L	mH	3.3	2.2	1.7	1.3	1.1	
Pole pair pitch	2τ	mm						60
Minimum bending radius of cable	R_{bend}	mm						57.5
Back emf constant (line to line)	K_v	$V_{rms}/(m/s)$						34.4
Motor constant(25°C)	K_m	N/\sqrt{W}	27.0	33.0	37.7	43.0	46.2	
Thermal resistance	R_{TH}	°C/W	0.84	0.56	0.41	0.34	0.27	
Thermal switch								PTC
Maximum DC bus voltage	V_{DC}							330
Mass of forcer	M_f	kg	2.50	3.75	5.00	6.25	7.50	
Unit mass of stator	M_s	kg/m						25.6
Length of forcer/dimension n	L_f	mm	260/7	380/10	500/13	620/16	740/19	
Length of stator/dimension N	L_s	mm						120mm/N=2, 180mm/N=3, 300mm/N=5

Note: 1. Values in this table are motor at 25°C ambient temperature and no forced cooling.
 2. Except dimensions, the electrical specifications are in $\pm 10\%$ of tolerance.
 3. We reserve the right of changes, please follow customer recognition drawings.

■ Force and velocity curve (DC bus voltage = 330 V_{DC})

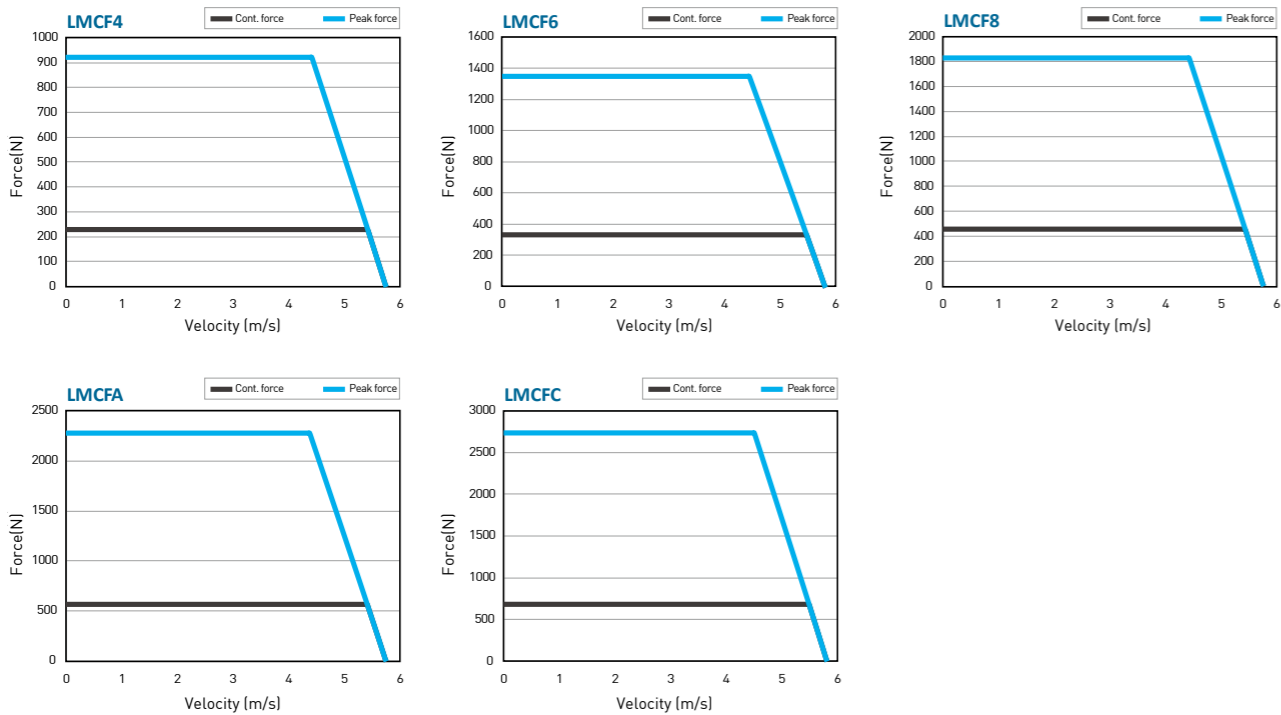

LMCF series forcers and stators dimensions

■ Dimensions of LMCF forcers

(Value for L_f and n : see Table2-9)

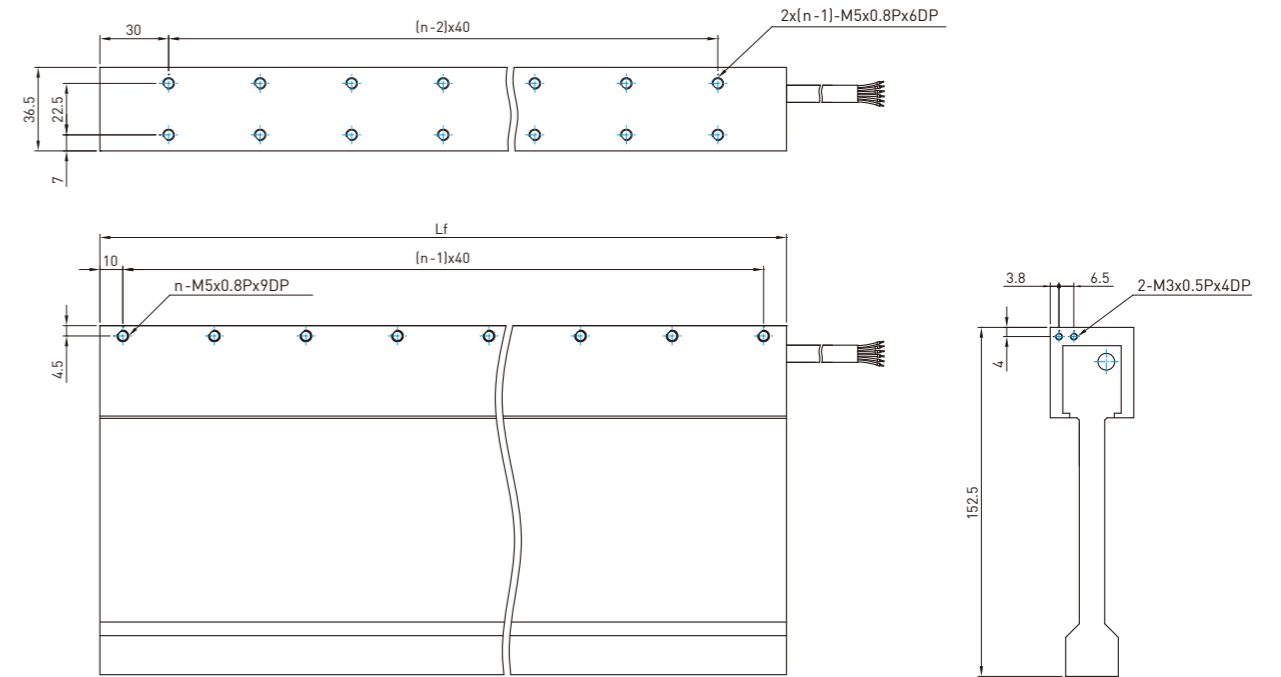

■ Dimensions of LMCF stators

(Value for L_s and N : see Table2-9)

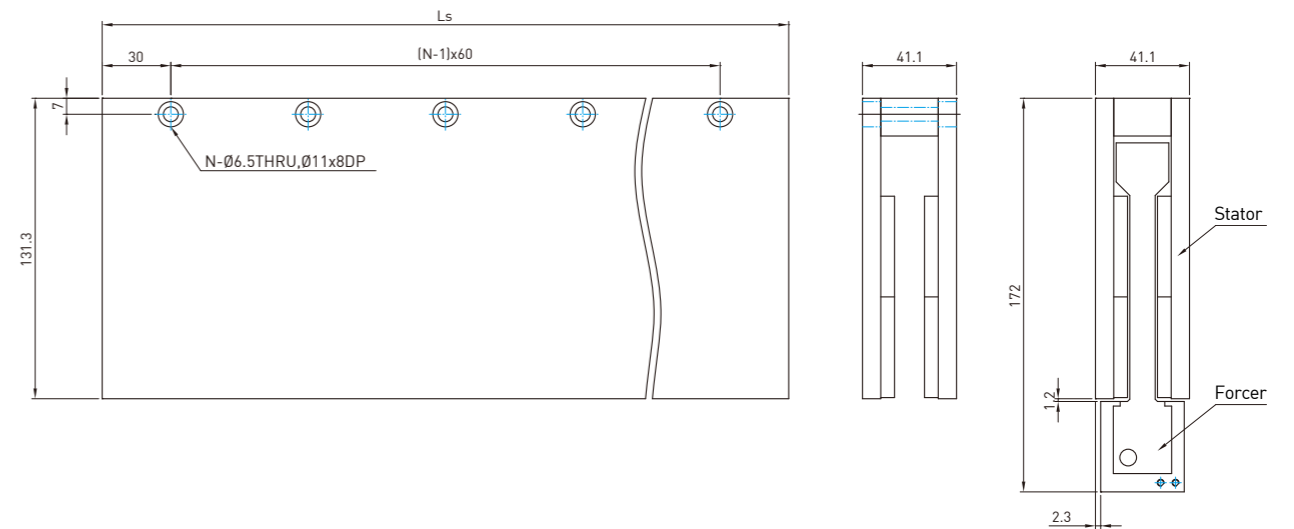

■ Mounting tolerances

Order code of magnet track (stator)

Series	Height of stator	Model	Length of stator
LMC	F:131.3mm	S: Standard	1:120mm B:180mm 2:300mm

2.4.7 LMC-EFC series

Table 2-10 LMC-EFC series specifications

	Symbol	Unit	LMC-EFC1	LMC-EFC2	LMC-EFC3	LMC-EFC4
Continuous force	F_c	N	38	75	113	150
Continuous current	I_c	A_{rms}			3.4	
Peak force (1s)	F_p	N	150	300	450	600
Peak current (1s)	I_p	A_{rms}	13.6	13.6	13.6	13.6
Force constant	K_f	N/A_{rms}	11.2	22.3	33.5	44.6
Maximum winding temperature	T_{max}	$^{\circ}C$			120	
Electrical time constant	K_e	ms			0.7	
Resistance (line to line, 25 $^{\circ}C$)	R_{25}	Ω	1.8	3.3	4.8	6.3
Inductance (line to line)	L	mH	1.2	2.3	3.4	4.5
Pole pair pitch	2τ	mm			60	
Minimum bending radius of cable	R_{bend}	mm			46.5	
Back emf constant (line to line)	K_v	$V_{rms}/(m/s)$	6.4	12.9	19.4	25.8
Motor constant(25 $^{\circ}C$)	K_m	N/\sqrt{W}	6.8	9.9	12.3	14.4
Thermal resistance	R_{TH}	$^{\circ}C/W$	2.31	1.26	0.87	0.66
Thermal switch					PTC	
Maximum DC bus voltage		V_{DC}			330	
Mass of forcer	M_f	kg	0.24	0.48	0.72	0.96
Unit mass of stator	M_s	kg/m			9.2	
Length of forcer/dimension n	L_f	mm	61	121/3	181/5	241/7
Height of forcer/dimension m	h	mm	59	59/3	59/4	59/6
Length of stator/dimension N	L_s	mm		120mm/N=2, 180mm/N=3, 300mm/N=5		
Heat sink dimension	-	mm		210x210x10		

Note: 1. Values in this table are motor at 25 $^{\circ}C$ ambient temperature and no forced cooling.
 2. Thermal resistance data are the values measured of forcer on heat sink.
 3. Except diemensions, the electrical specifications are in $\pm 10\%$ of tolerance.
 4. We reserve the right of changes, please follow customer recognition drawings.

Force and velocity curve(DC bus voltage = 330 V_{DC})

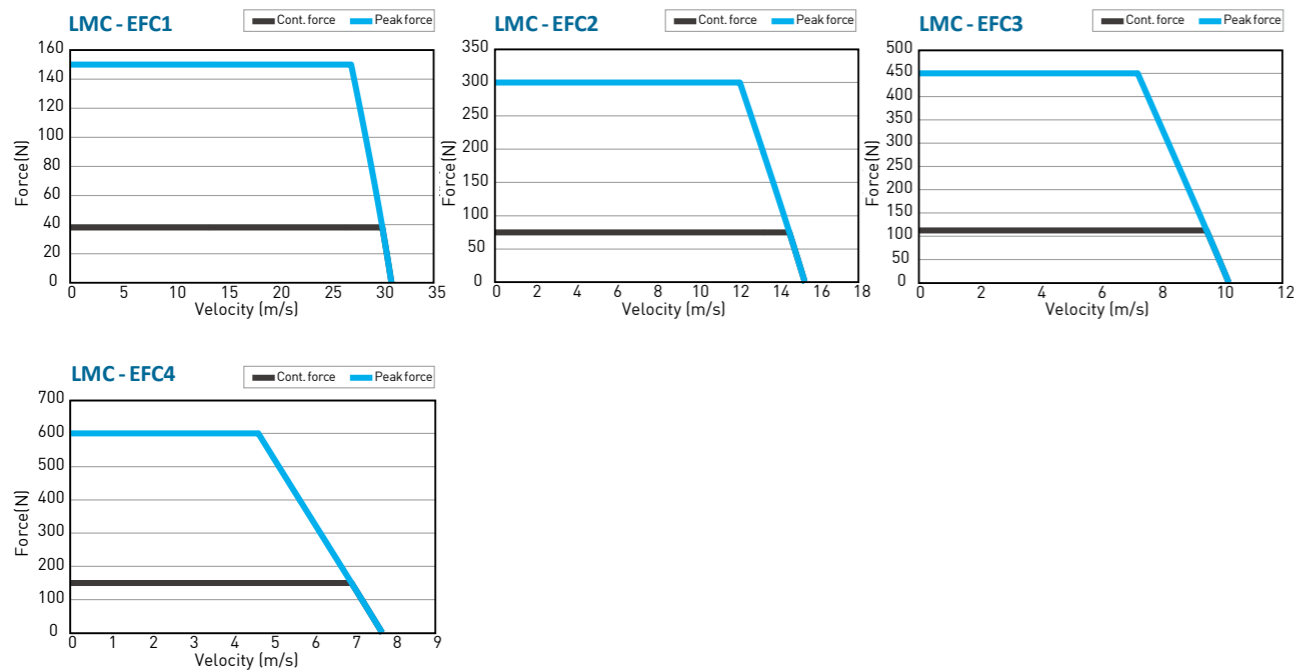

LMC-EFC series forcers and stators dimensions

Dimensions of LMC-EFC forcers (Value for L_f and n : see Table2-10)

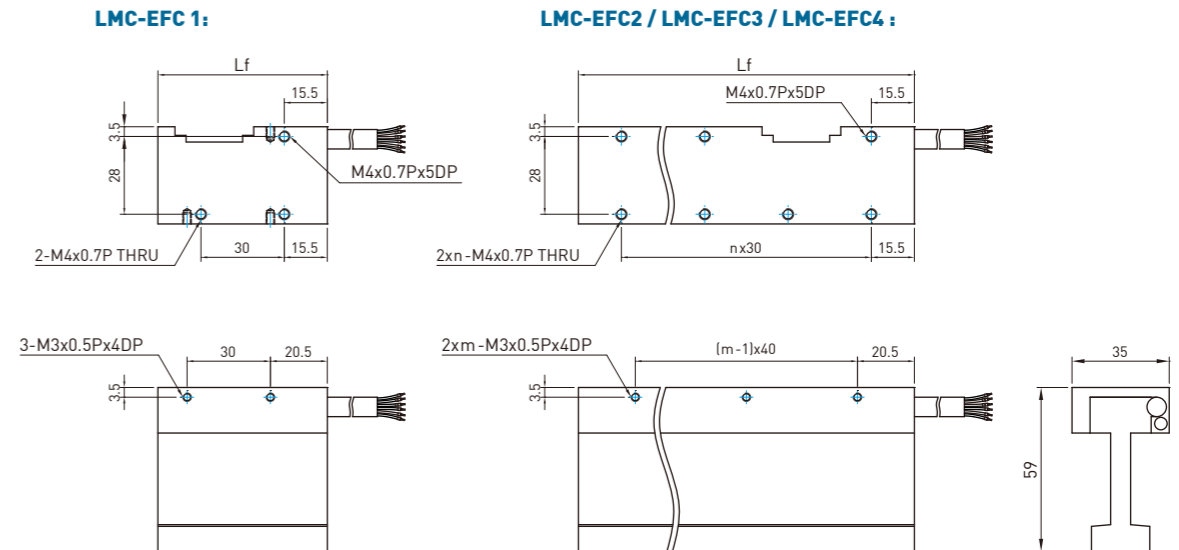

Dimensions of LMC-EFC stators (Value for L_s and N : see Table2-10)

Mounting tolerances

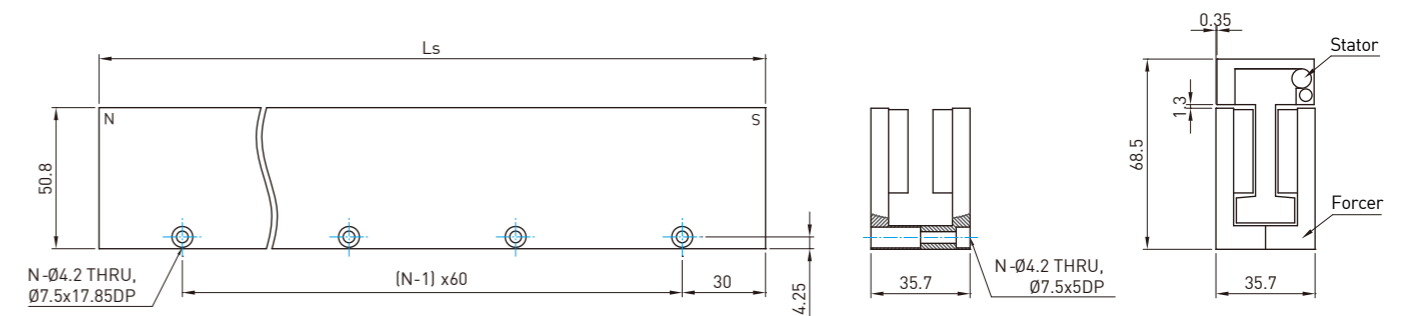

Order code of magnet track (stator)

Series	Height of stator	Model	Length of stator
LMC	EFC:50.8mm	S	1
		S: Standard	1:120mm B:180mm 2:300mm

2.4.8 LMC-EFE series

Table 2-11 LMC-EFE series specifications

	Symbol	Unit	LMC-EFE1	LMC-EFE2	LMC-EFE3	LMC-EFE4	LMC-EFE5	LMC-EFE6
Continuous force	F_c	N	50	100	150	200	250	300
Continuous current	I_c	A_{rms}	2.7	2.7	2.7	2.7	2.7	5.4
Peak force (1s)	F_p	N	200	400	600	800	1000	1200
Peak current (1s)	I_p	A_{rms}	10.8	10.8	10.8	10.8	10.8	21.7
Force constant	K_f	N/A_{rms}	18.5	37.0	55.4	73.9	92.4	55.4
Maximum winding temperature	T_{max}	$^{\circ}C$	120					
Electrical time constant	K_e	ms	0.85					
Resistance (line to line, 25 $^{\circ}C$)	R_{25}	Ω	1.8	3.6	5.4	7.1	8.9	2.7
Inductance (line to line)	L	mH	1.5	3.1	4.6	6.1	7.6	2.3
Pole pair pitch	2τ	mm	60					
Minimum bending radius of cable	R_{bend}	mm	37.5					
Back emf constant (line to line)	K_v	$V_{rms}/(m/s)$	10.7	21.3	32.0	42.7	53.3	32.0
Motor constant(25 $^{\circ}C$)	K_m	N/\sqrt{W}	11.3	16.0	19.5	22.6	25.2	27.6
Thermal resistance	R_{th}	$^{\circ}C/W$	3.67	1.83	1.22	0.92	0.73	0.61
Thermal switch			PTC					
Maximum DC bus voltage	V		330					
Mass of forcer	M_f	kg	0.30	0.60	0.90	1.20	1.50	1.80
Unit mass of stator	M_s	kg/m	15.8					
Length of forcer/dimension n	L_f	mm	61	121/3	181/5	241/7	301/9	361/11
Height of forcer/dimension m	h	mm	79	79/3	79/4	79/6	79/7	79/9
Height of stator	H_s	mm	75.3					
Width of stator	W_s	mm	38.7					
Length of stator/dimension N	L_s	mm	120mm/N=2, 180mm/N=3, 300mm/N=5					
Total installation height	H	mm	93					
Heat sink dimension	-	mm	210x210x10					

Note: 1. Values in this table are motor at 25 $^{\circ}C$ ambient temperature and no forced cooling.
 2. Thermal resistance data are the values measured of forcer on heat sink.
 3. Except dimensions, the electrical specifications are in $\pm 10\%$ of tolerance.
 4. We reserve the right of changes, please follow customer recognition drawings.

Force and velocity curve(DC bus voltage = 330 V_{DC})

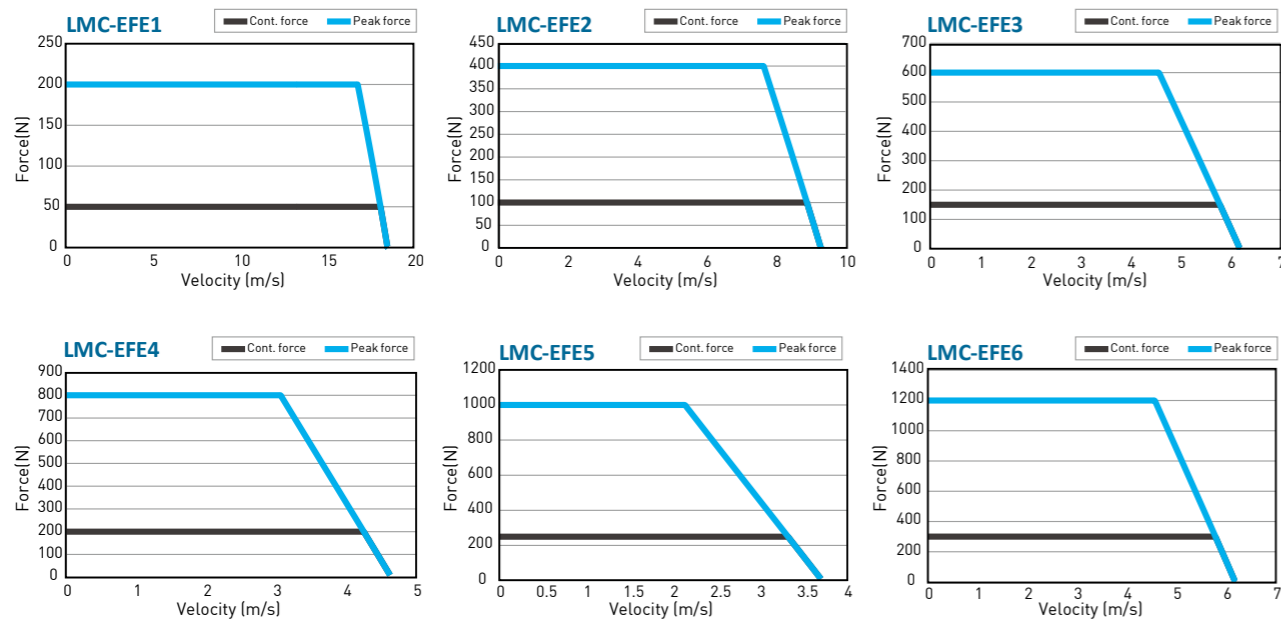

LMC-EFE series forcers and stators dimensions

Dimensions of LMC-EFE forcers

(Value for L_f and n : see Table2-11)

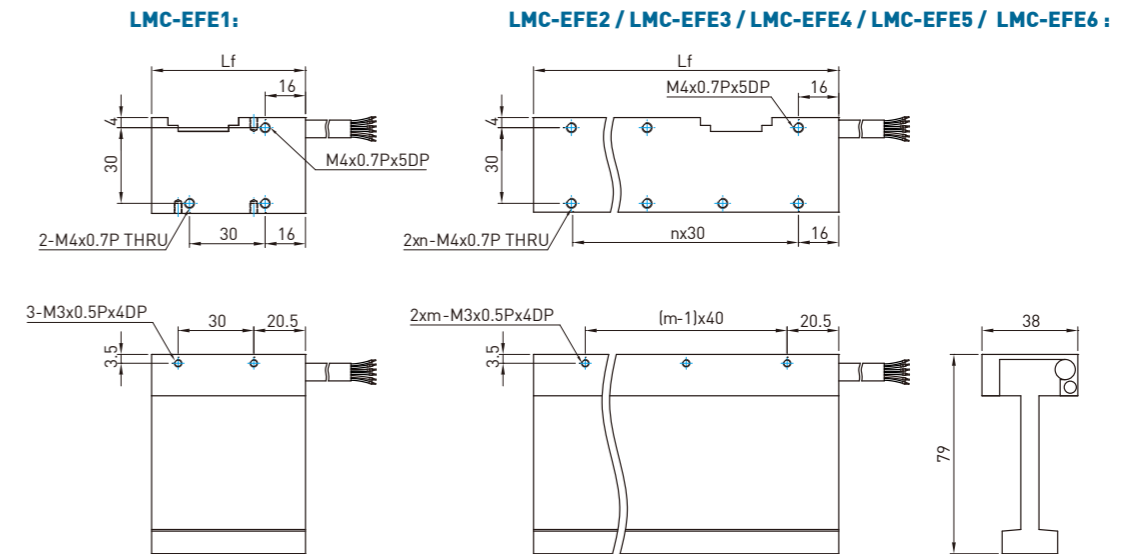

Dimensions of LMC-EFE stators

(Value for L_s and N : see Table2-11)

Mounting tolerances

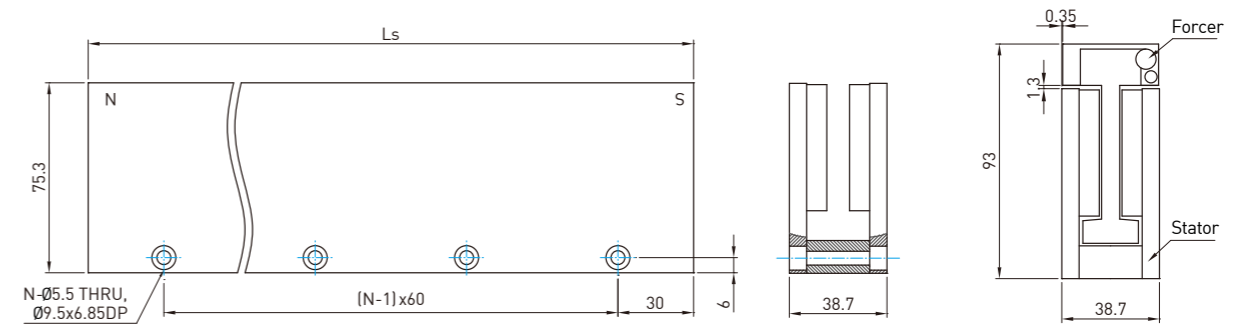

Order code of magnet track (stator)

Series	Height of stator	Model	Length of stator
LMC	EFE:75.3mm	S	1
		S: Standard	1:120mm B:180mm 2:300mm

2.4.9 LMC-EFF series

Table 2-12 LMC-EFF series specifications

	Symbol	Unit	LMC-EFF1	LMC-EFF2	LMC-EFF3	LMC-EFF4	LMC-EFF5	LMC-EFF6	LMC-EFF7	LMC-EFF8	LMC-EFF9	LMC-EFFA	LMC-EFFB	LMC-EFFC	LMC-EFFD
Continuous force	F_c	N	77	154	231	309	386	463	540	617	694	771	849	926	1003
Continuous current	I_c	A_{rms}	5.7												
Peak force (1s)	F_p	N	309	617	926	1234	1543	1852	2160	2469	2777	3086	3394	3703	4012
Peak current (1s)	I_p	A_{rms}	22.6												
Force constant	K_f	N/A_{rms}	13.7	27.3	41.0	54.6	68.3	81.9	95.6	109.2	122.9	136.5	150.2	163.9	177.5
Maximum winding temperature	T_{max}	$^{\circ}C$	120												
Electrical time constant	K_e	ms	1.5												
Resistance (line to line, 25 $^{\circ}C$)	R_{25}	Ω	0.6	1.2	1.7	2.3	2.9	3.5	4.1	4.6	5.2	5.8	6.4	7	7.5
Inductance (line to line)	L	mH	0.9	1.7	2.6	3.5	4.3	5.2	6.1	6.9	7.8	8.7	9.6	10.4	11.3
Pole pair pitch	2τ	mm	60												
Minimum bending radius of cable	R_{bend}	mm	37.5												
Back emf constant (line to line)	K_v	$V_{rms}/(m/s)$	7.9	15.8	23.7	31.5	39.4	47.3	55.2	63.1	71.0	78.8	86.7	94.6	102.5
Motor constant(25 $^{\circ}C$)	K_m	N/\sqrt{W}	14.6	20.7	25.4	29.3	32.7	35.9	38.7	41.4	43.9	46.3	48.6	50.7	52.8
Thermal resistance	R_{TH}	$^{\circ}C/W$	2.59	1.30	0.86	0.65	0.52	0.43	0.37	0.32	0.29	0.26	0.24	0.22	0.20
Thermal switch			PTC												
Maximum DC bus voltage	V_{DC}		330												
Mass of forcer	M_f	kg	0.7	1.3	2.0	2.7	3.3	4.0	4.7	5.3	6.0	6.7	7.3	8.0	8.7
Unit mass of stator	M_s	kg/m	24.7												
Length of forcer/dimension n	L_f	mm	61	121/3	181/5	241/7	301/9	361/11	421/13	481/15	541/17	601/19	661/21	721/23	718/25
Length of stator/dimension N	L_s	mm	120mm/N=2, 180mm/N=3, 300mm/N=5												
Heat sink dimension		mm	210x210x10												

Note: 1. Values in this table are motor at 25 $^{\circ}C$ ambient temperature and no forced cooling.
 2. Thermal resistance data are the values measured of forcer on heat sink.
 3. Except dimensions, the electrical specifications are in $\pm 10\%$ of tolerance.
 4. We reserve the right of changes, please follow customer recognition drawings.

Force and velocity curve(DC bus voltage = 330 V_{DC})

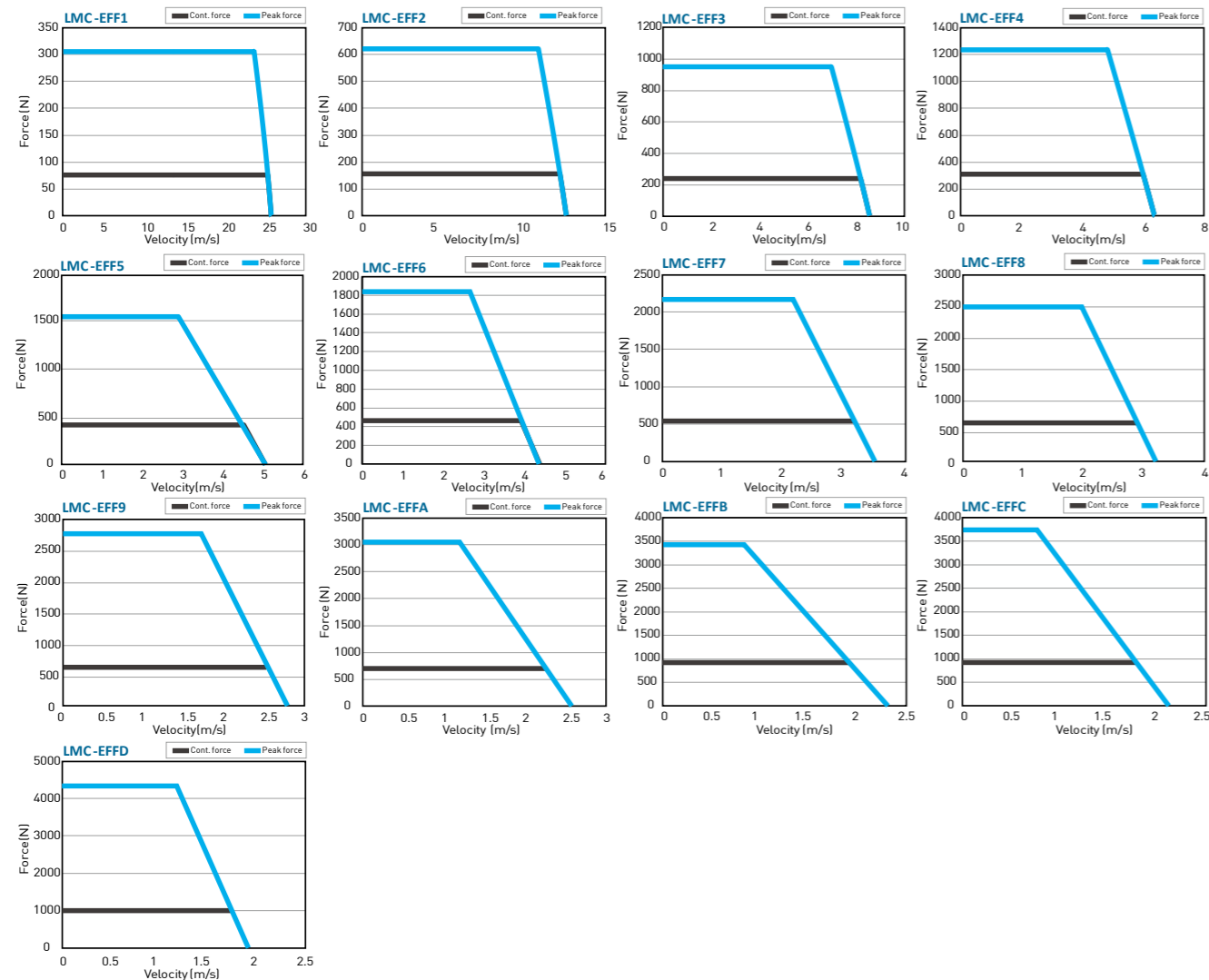

LMC-EFF series forcers and stators dimensions

Dimensions of LMC-EFF forcers

(Value for L_f and n : see Table2-12)

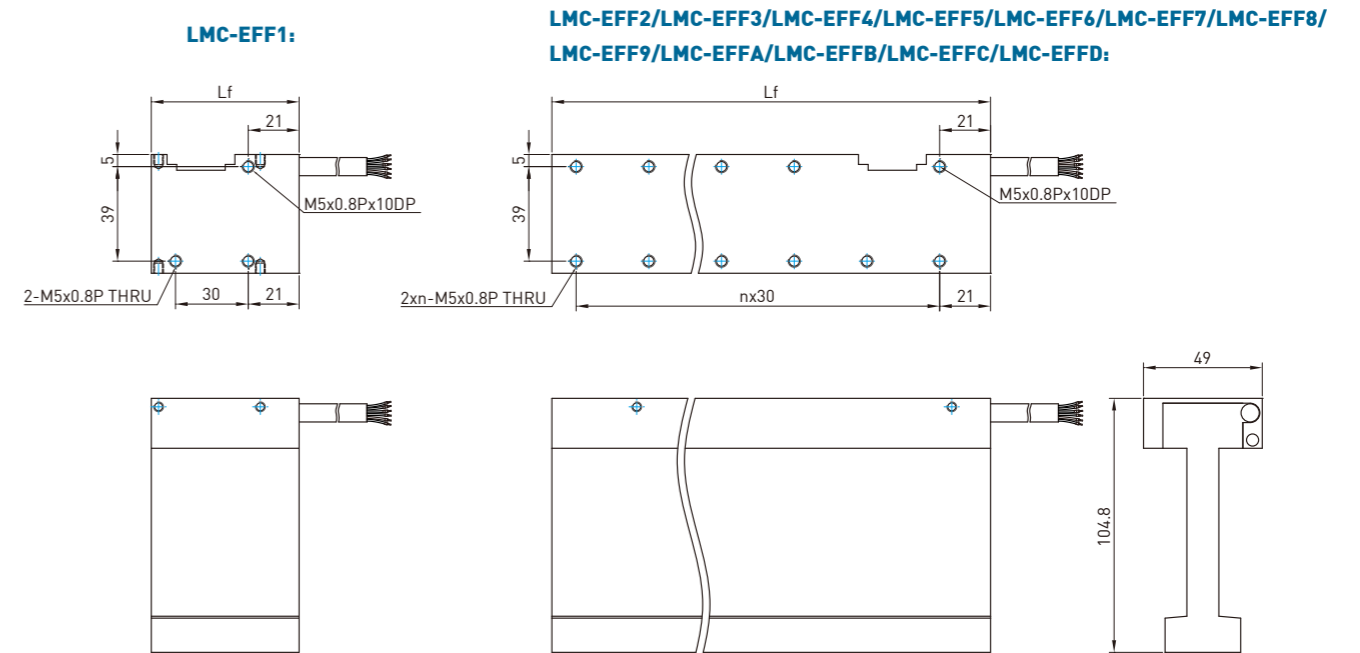

Dimensions of LMC-EFF stators

(Value for L_s and N : see Table2-12)

Mounting tolerances

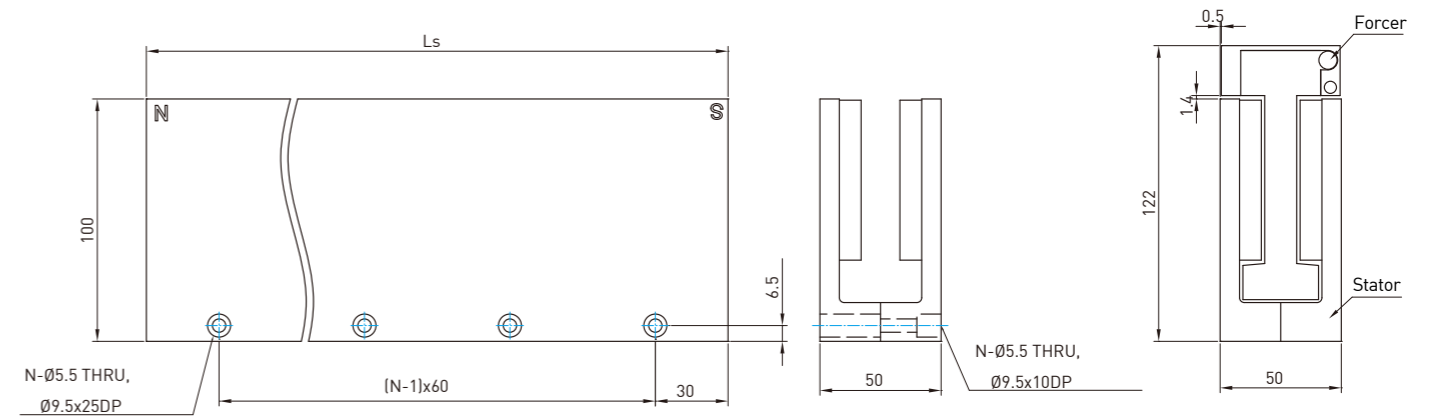

Order code of magnet track (stator)

Series	Height of stator	Model	Length of stator
LMC	EFF	S	1
	EFF:100mm	S: Standard	1:120mm B:180mm 2:300mm

2.4.10 LMC-HUB series

Table 2-13 LMC-HUB series specifications

	Symbol	Unit	LMC-HUB1	LMC-HUB2
Continuous force	F_c	N	20	40
Continuous current	I_c	A_{rms}	1.5	3.1
Peak force (1s)	F_p	N	80	160
Peak current (1s)	I_p	A_{rms}	6.2	12.3
Force constant	K_f	N/A_{rms}		13.0
Maximum winding temperature	T_{max}	$^{\circ}C$		120
Electrical time constant	K_e	ms		0.19
Resistance (line to line, 25 $^{\circ}C$)	R_{25}	Ω	7.5	3.8
Inductance (line to line)	L	mH	1.4	0.7
Pole pair pitch	2τ	mm		24
Minimum bending radius of cable	R_{bend}	mm		27.5
Back emf constant (line to line)	K_v	$V_{rms}/(m/s)$		7.5
Motor constant(25 $^{\circ}C$)	K_m	N/\sqrt{W}	3.9	5.5
Thermal resistance	R_{th}	$^{\circ}C/W$	2.68	1.34
Thermal switch				PTC
Maximum DC bus voltage		V_{DC}		330
Mass of forcer	M_f	kg	0.05	0.10
Unit mass of stator	M_s	kg/m		3.4
Length of forcer	L_f	mm	49	97
Length of stator	L_s	mm		72mm, 120mm
Heat sink dimension		mm		100x60x14

Note: 1. Values in this table are motor at 25 $^{\circ}C$ ambient temperature and no forced cooling.
 2. Thermal resistance data are the values measured of forcer on heat sink.
 3. Except diemensions, the electrical specifications are in $\pm 10\%$ of tolerance.
 4. We reserve the right of changes, please follow customer recognition drawings.

LMC-HUB series forcers and stators dimensions

■ Dimensions of LMC-HUB forcers

(Value for L_f : see Table2-13)

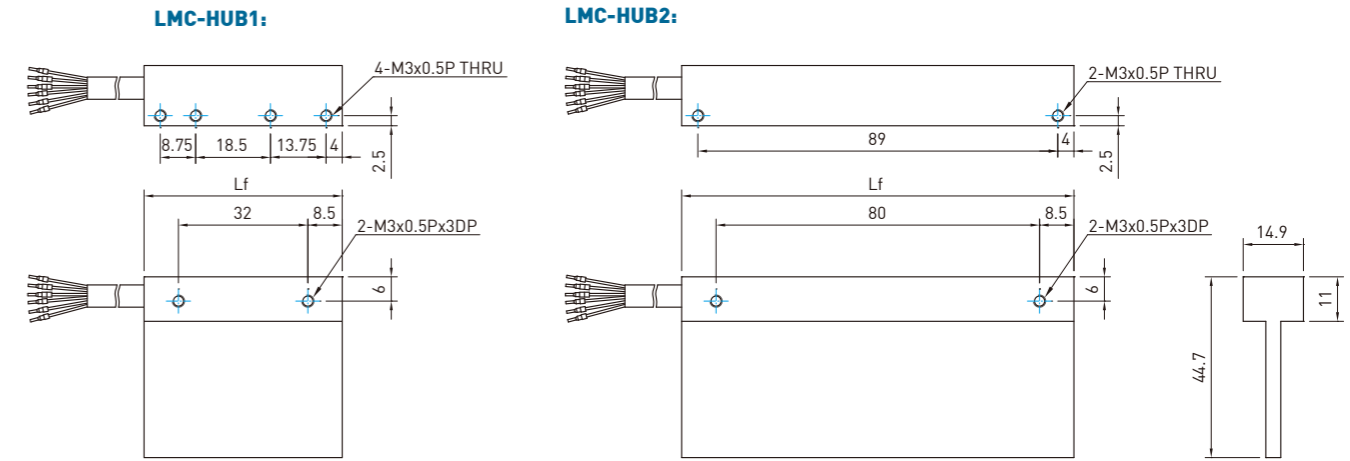

■ Dimensions of LMC-HUB stators

(Value for L_s : see Table2-13)

■ Mounting tolerances

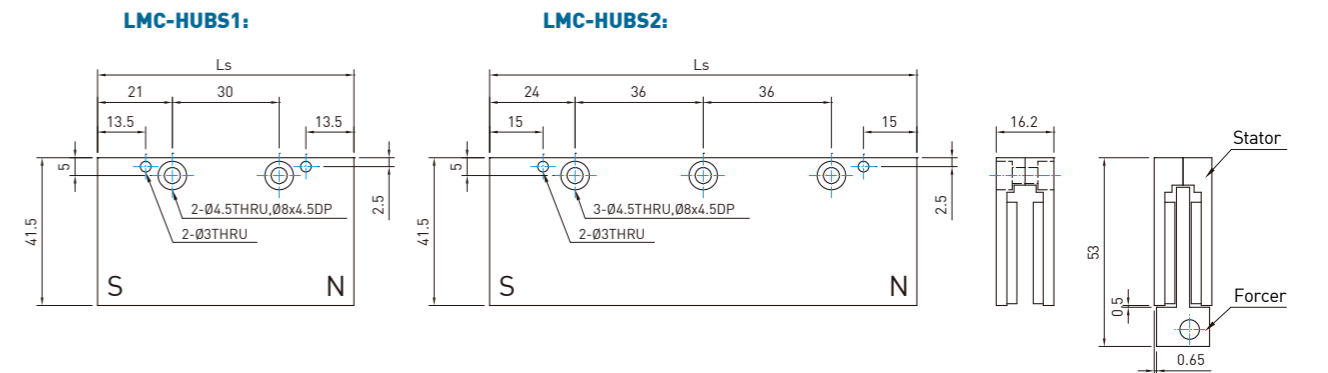

■ Force and velocity curve(DC bus voltage = 330 V_{DC})

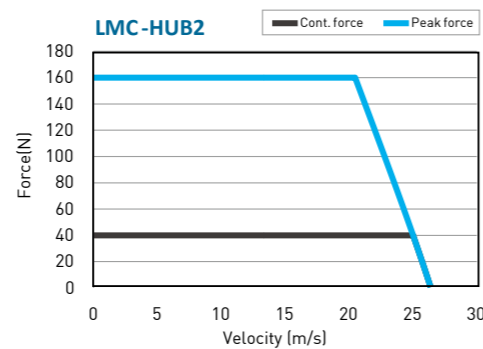
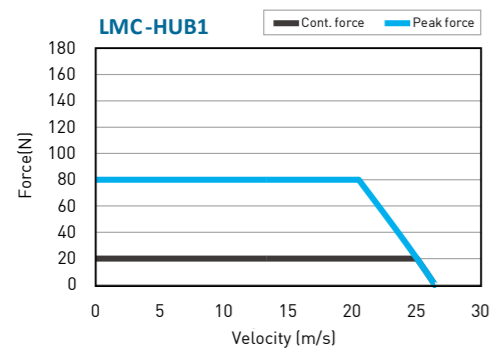

Order code of magnet track (stator)

Series	Height of stator	Model	Length of stator
LMC	HUB	S	1
	HUB:41.5mm	S: Standard	1:72mm 2:120mm

2.5 LMT series Linear motor

The HIWIN rod-shaped linear motor has a variety of size series, with complete specifications, and easy installation. The maximum peak force for this motor is up to about 2570N. It complies with international safety CE certification, has dustproof and a waterproof IP66 rating. Using direct drive technology, no other mechanical conversion components are needed to achieve linear transmission, with high-speed, no cogging and low velocity ripple along with other characteristics including; excellent dynamic performance, no wear, zero backlash, and easy maintenance. Compared to traditional mechanical linear solutions, the motor effectively enhances machine equipment production capacity and reduces maintenance costs to meet the needs of high-precision positioning control and smooth operation applications such as high-speed light-load automation equipment, dust-free environment, automation equipment, panel equipment, optical inspection equipment, tool line cutting equipment, scanning electron microscope equipment, medical automation and other industries.

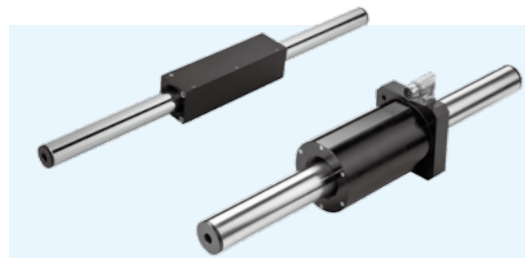

- Excellent dynamic characteristics: no cogging
- low velocity ripple
- Max. Acceleration up to 5G
- CE certification
- Ingress Protection rating: IP66
- No wear, zero backlash
- Similar to screw mechanism, easy to install

Force chart for LMT series

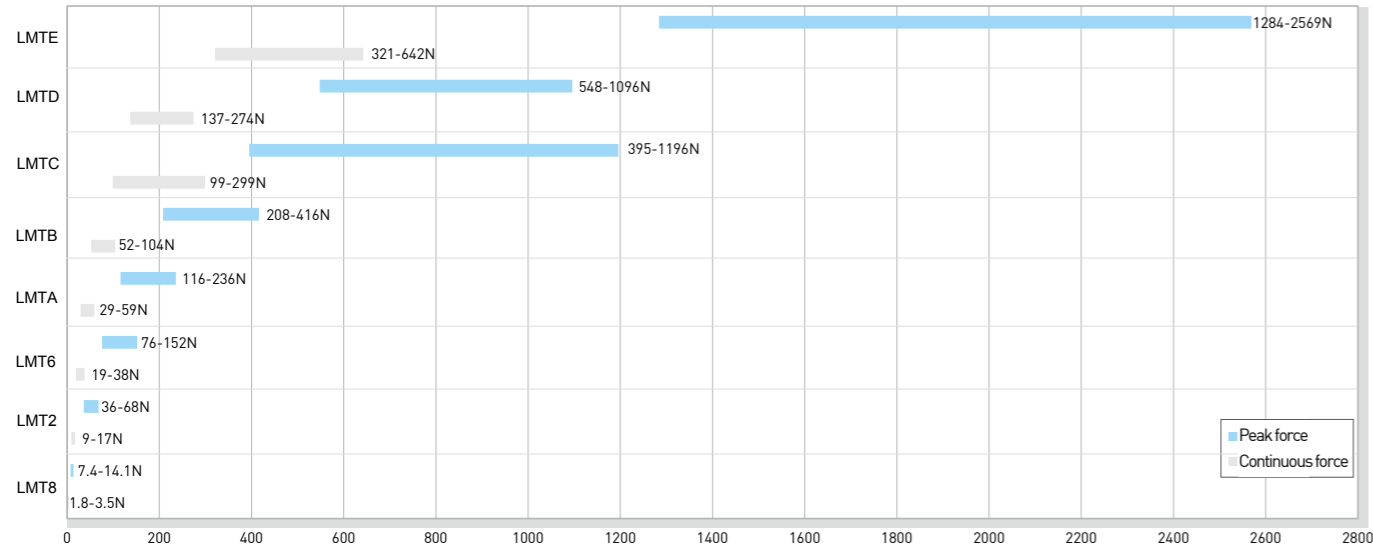

2.5.1 LMT8 series

Table 2-14 LMT8 series specifications

	Symbol	Unit	LMT8D	LMT8T	LMT8Q
Continuous force	F_c	N	1.8	2.7	3.5
Continuous current	I_c	A_{rms}		0.8	
Peak force (1s)	F_p	N	7.4	10.9	14.1
Peak current (1s)	I_p	A_{rms}		3.2	
Force constant	K_f	N/A_{rms}	2.3	3.4	4.4
Electrical time constant	K_e	ms		0.14	
Resistance (line to line · 25°C)	R_{25}	Ω	4.9	7.3	9.7
Inductance (line to line)	L	mH	0.7	1.0	1.4
Pole pair pitch	2τ	mm		30	
Minimum bending radius of cable	R_{bend}	mm		37.5	
Back emf constant (line to line)	K_v	$V_{rms}/(m/s)$	1.4	2.1	2.8
Motor constant(25°C)	K_m	N/\sqrt{W}	0.8	1.0	1.2
Thermal resistance	R_{TH}	$^{\circ}C/W$	14.8	9.9	7.5
Thermal switch				PTC	
Maximum DC bus voltage	V_{DC}			325	
Mass of forcer	M_f	kg	0.05	0.07	0.10
Unit mass of stator	M_s	kg/m		0.4	
Length of forcer	L_f	mm	40	55	70
Mounting pitch	$P_1 \times P_2$	mm	34x10	49x10	64x10
Stroke	S	mm		25,50,100,150,200	
Clamping length	L_1	mm		10	
Total stator length	L_s	mm	$L_s(\text{Total stator length})=S(\text{Stroke})+L_f(\text{Length of forcer})+2*L_1(\text{Clamping length})$		

Note: 1. Values in the table refer to operation without forced cooling.
2. Except dimensions, the electrical specifications are in $\pm 10\%$ of tolerance.
3. We reserve the right of changes, please follow customer recognition drawings.

Force and velocity curve (DC bus voltage = 325 V_{DC})

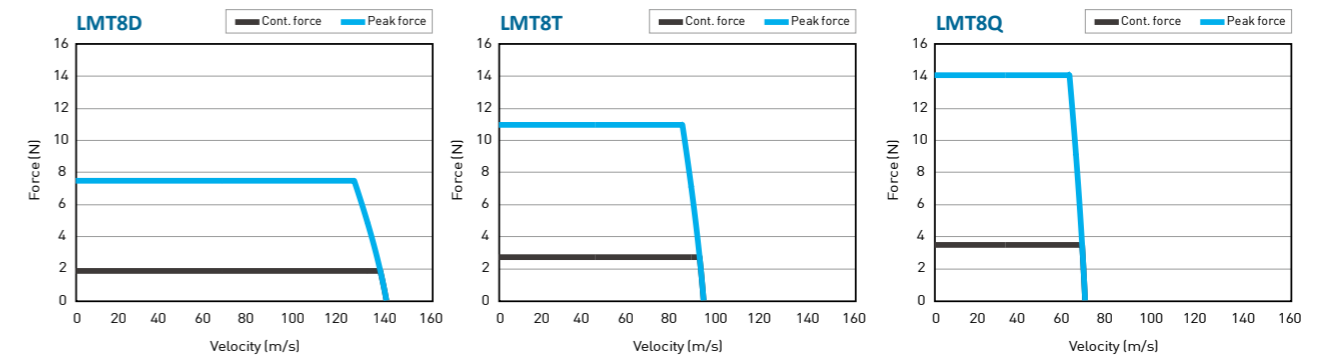

Dimensions of LMT8 forcers and stators

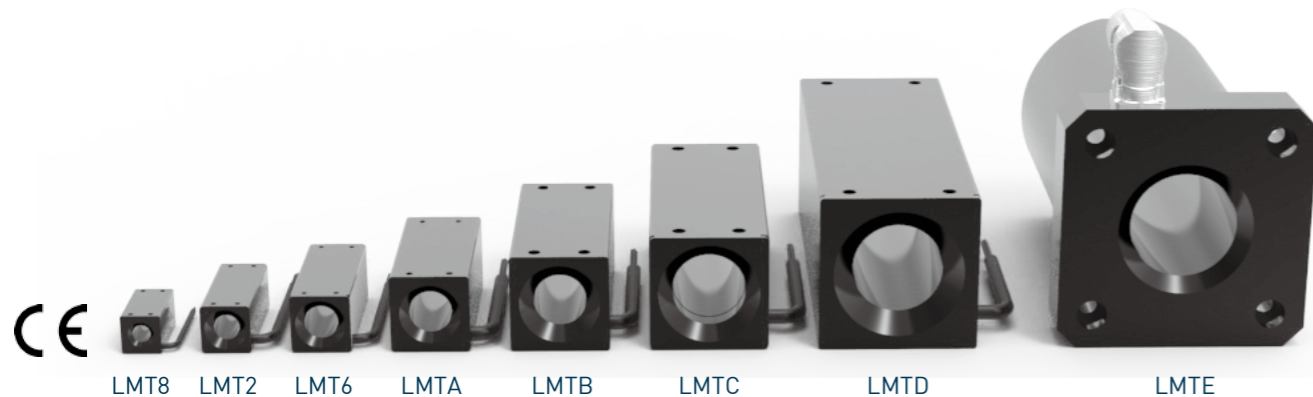
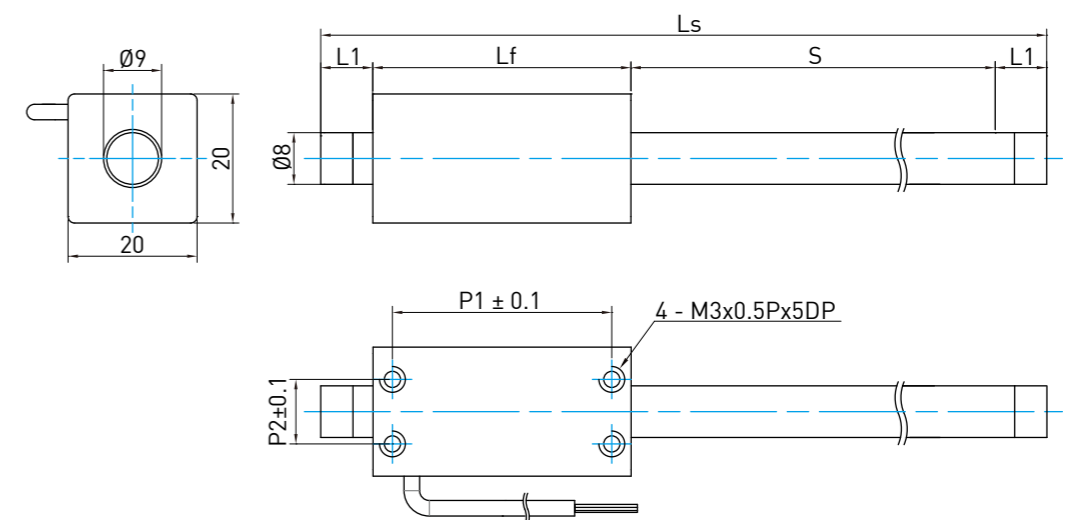

LMT8 LMT2 LMT6 LMTA LMTB LMTC LMTD LMTE

2.5.2 LMT2 series

Table 2-15 LMT2 series specifications

	Symbol	Unit	LMT2D	LMT2T	LMT2Q
Continuous force	F_c	N	9	13	17
Continuous current	I_c	A_{rms}		1.5	
Peak force (1s)	F_p	N	36	52	68
Peak current (1s)	I_p	A_{rms}		6	
Force constant	K_f	N/A_{rms}	5.7	8.6	11.4
Electrical time constant	K_e	ms		0.3	
Resistance (line to line · 25°C)	R_{25}	Ω	4.2	6.3	8.4
Inductance (line to line)	L	mH	1.1	1.7	2.2
Pole pair pitch	2τ	mm		48	
Minimum bending radius of cable	R_{bend}	mm		31	
Back emf constant (line to line)	K_v	$V_{rms}/(m/s)$	2.8	4.2	5.6
Motor constant(25°C)	K_m	N/\sqrt{W}	2.4	2.8	3.2
Thermal resistance	R_{TH}	$^{\circ}C/W$	5.4	3.6	2.7
Thermal switch				PTC	
Maximum DC bus voltage	V_{DC}			325	
Mass of forcer	M_f	kg	0.12	0.15	0.19
Unit mass of stator	M_s	kg/m		0.9	
Length of forcer	L_f	mm	64	88	112
Mounting pitch	$P_1 \times P_2$	mm	56x12	80x12	104x12
Stroke	S	mm	50~1050 (Take 50 mm as increase unit)		
Clamping length	L_1	mm	25 (Stroke=50 mm~350 mm) 40 (Stroke=400 mm~800 mm) 60 (Stroke=850 mm~1050 mm)		
Total stator length	L_s	mm	$L_s(\text{Total stator length})=S(\text{Stroke})+L_f(\text{Length of forcer})+2*L_1(\text{Clamping length})$		

Note: 1. Values in the table refer to operation without forced cooling.
2. Except dimensions, the electrical specifications are in $\pm 10\%$ of tolerance.
3. We reserve the right of changes, please follow customer recognition drawings.

Force and velocity curve (DC bus voltage = 325 V_{DC})

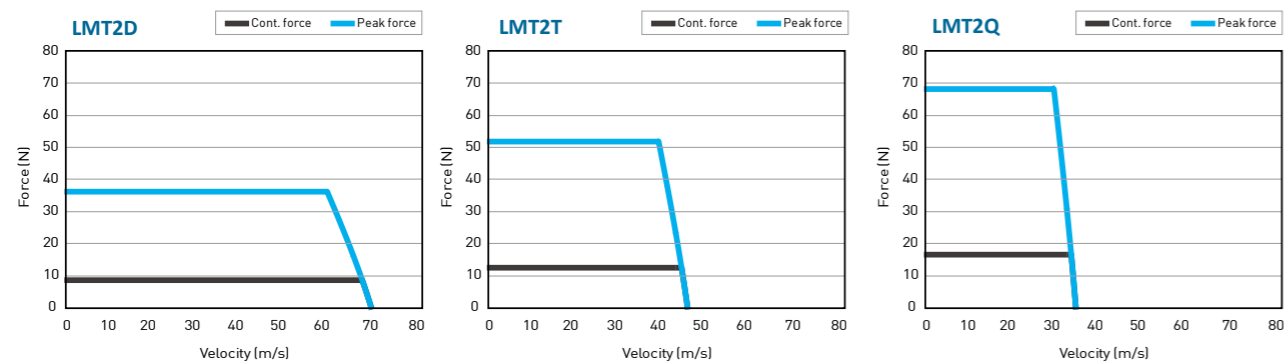

Dimensions of LMT2 forcers and stators

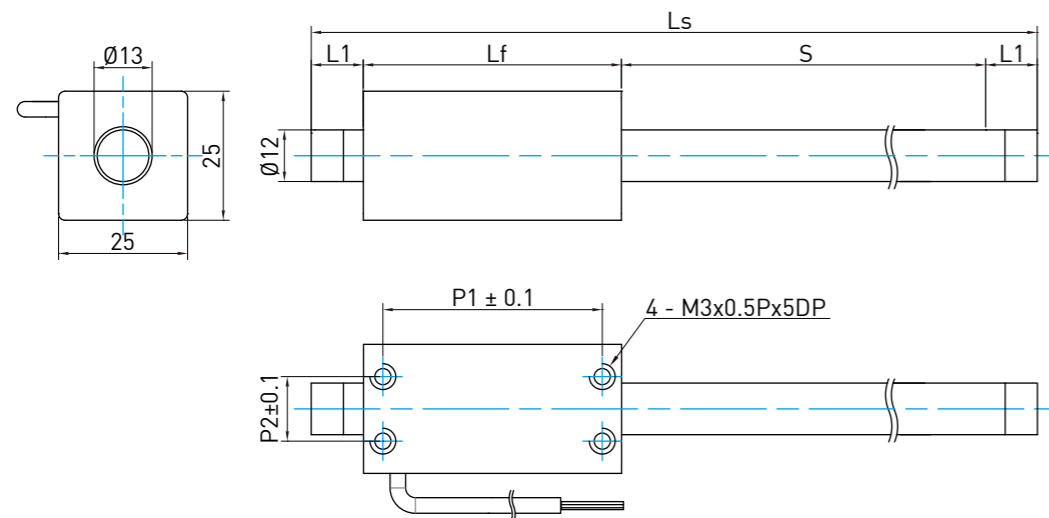

2.5.3 LMT6 series

Table 2-16 LMT6 series specifications

	Symbol	Unit	LMT6D	LMT6T	LMT6Q
Continuous force	F_c	N	19	28	38
Continuous current	I_c	A_{rms}		1.4	
Peak force (1s)	F_p	N	76	112	152
Peak current (1s)	I_p	A_{rms}		5.6	
Force constant	K_f	N/A_{rms}	13.4	20.1	26.8
Electrical time constant	K_e	ms		0.4	
Resistance (line to line · 25°C)	R_{25}	Ω	7.3	10.9	14.5
Inductance (line to line)	L	mH	2.8	4.3	5.7
Pole pair pitch	2τ	mm		60	
Minimum bending radius of cable	R_{bend}	mm		31	
Back emf constant (line to line)	K_v	$V_{rms}/(m/s)$	6.6	9.8	13.2
Motor constant(25°C)	K_m	N/\sqrt{W}	4.1	4.9	5.8
Thermal resistance	R_{TH}	$^{\circ}C/W$	3.6	2.4	1.8
Thermal switch				PTC	
Maximum DC bus voltage	V_{DC}			325	
Mass of forcer	M_f	kg	0.20	0.26	0.34
Unit mass of stator	M_s	kg/m		1.4	
Length of forcer	L_f	mm	80	110	140
Mounting pitch	$P_1 \times P_2$	mm	70x16	100x16	130x16
Stroke	S	mm	100~1050 (Take 50 mm as increase unit)		
Clamping length	L_1	mm	25 (Stroke=100 mm~350 mm) 40 (Stroke=400 mm~800 mm) 60 (Stroke=850 mm~1050 mm)		
Total stator length	L_s	mm	$L_s(\text{Total stator length})=S(\text{Stroke})+L_f(\text{Length of forcer})+2*L_1(\text{Clamping length})$		

Note: 1. Values in the table refer to operation without forced cooling.
2. Except dimensions, the electrical specifications are in $\pm 10\%$ of tolerance.
3. We reserve the right of changes, please follow customer recognition drawings.

Force and velocity curve (DC bus voltage = 325 V_{DC})

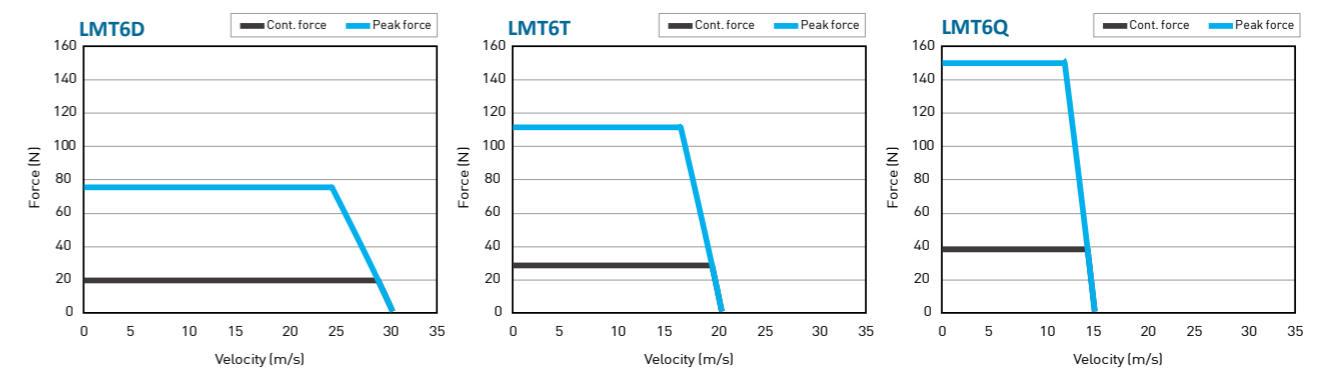

Dimensions of LMT6 forcers and stators

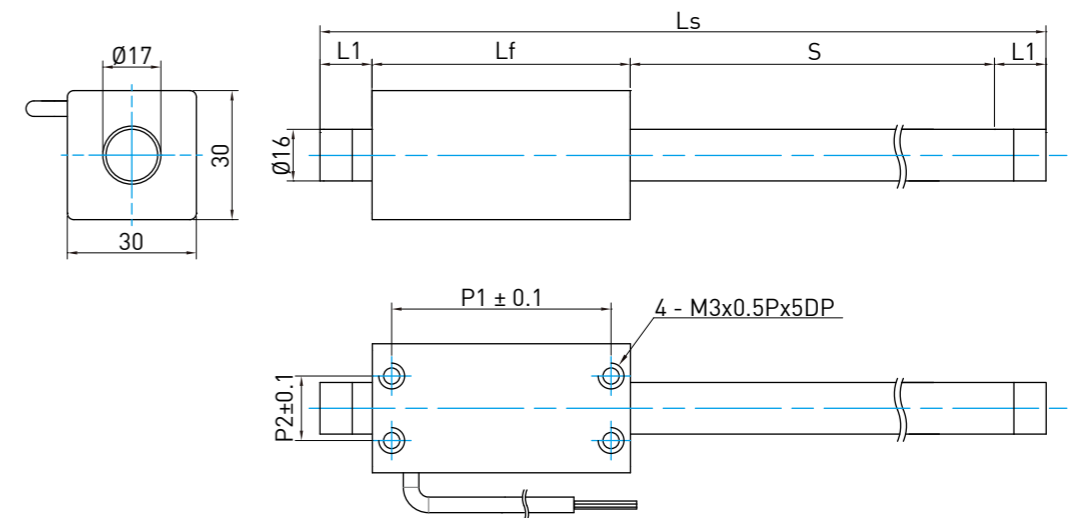

2.5.4 LMTA series

Table 2-17 LMTA series specifications

	Symbol	Unit	LMTA2	LMTA3	LMTA4
Continuous force	F_c	N	29	45	59
Continuous current	I_c	A_{rms}		1.6	
Peak force (1s)	F_p	N	116	180	236
Peak current (1s)	I_p	A_{rms}		6.4	
Force constant	K_f	N/A_{rms}	18	28	37
Electrical time constant	K_e	ms		0.7	
Resistance (line to line · 25°C)	R_{25}	Ω	7.4	11.1	14.8
Inductance (line to line)	L	mH	5.0	7.5	10.0
Pole pair pitch	2τ	mm		72	
Minimum bending radius of cable	R_{bend}	mm		37.5	
Back emf constant (line to line)	K_v	$V_{rms}/(m/s)$	11.7	17.5	23.3
Motor constant(25°C)	K_m	N/\sqrt{W}	5.4	6.9	7.9
Thermal resistance	R_{TH}	$^{\circ}C/W$	2.4	1.6	1.2
Thermal switch				PTC	
Maximum DC bus voltage		V_{DC}		325	
Mass of forcer	M_f	kg	0.45	0.63	0.80
Unit mass of stator	M_s	kg/m		2	
Length of forcer	L_f	mm	94	130	166
Mounting pitch	$P_1 \times P_2$	mm	84x20	120x20	156x20
Stroke	S	mm	100~1550 (Take 50 mm as increase unit)		
Clamping length	L_1	mm	25 (Stroke=100 mm~300 mm) 40 (Stroke=350 mm~700 mm) 60 (Stroke=750 mm~1550 mm)		
Total stator length	L_s	mm	$L_s(\text{Total stator length})=S(\text{Stroke})+L_f(\text{Length of forcer})+2*L_1(\text{Clamping length})$		

Note: 1. Values in the table refer to operation without forced cooling.
2. Except dimensions, the electrical specifications are in $\pm 10\%$ of tolerance.
3. We reserve the right of changes, please follow customer recognition drawings.

Force and velocity curve(DC bus voltage = 325 V_{DC})

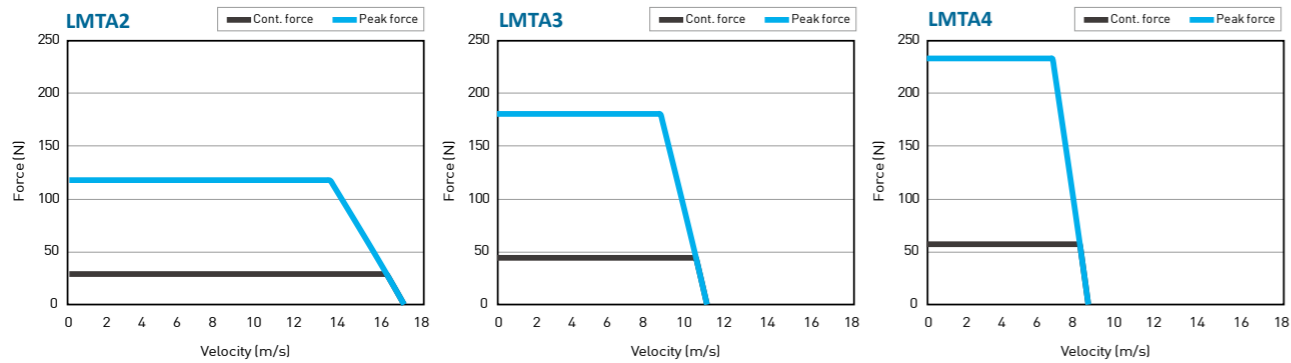

Dimensions of LMTA forcers and stators

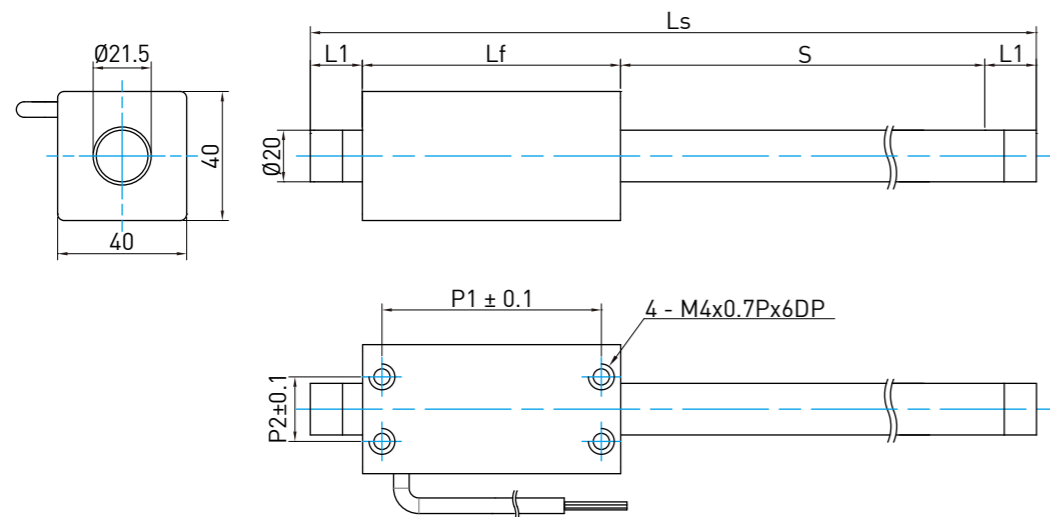

2.5.5 LMTB series

Table 2-18 LMTB series specifications

	Symbol	Unit	LMTB2	LMTB3	LMTB4
Continuous force	F_c	N	52	78	104
Continuous current	I_c	A_{rms}		1.3	
Peak force (1s)	F_p	N	208	312	416
Peak current (1s)	I_p	A_{rms}		5.2	
Force constant	K_f	N/A_{rms}	40	60	80
Electrical time constant	K_e	ms		1	
Resistance (line to line · 25°C)	R_{25}	Ω	16.0	24.0	32.4
Inductance (line to line)	L	mH	16.5	24.7	33.0
Pole pair pitch	2τ	mm		90	
Minimum bending radius of cable	R_{bend}	mm		37.5	
Back emf constant (line to line)	K_v	$V_{rms}/(m/s)$	22	33	44
Motor constant(25°C)	K_m	N/\sqrt{W}	8.2	10.0	11.6
Thermal resistance	R_{TH}	$^{\circ}C/W$	1.7	1.2	0.9
Thermal switch				PTC	
Maximum DC bus voltage		V_{DC}		325	
Mass of forcer	M_f	kg	0.88	1.25	1.65
Unit mass of stator	M_s	kg/m		3.2	
Length of forcer	L_f	mm	120	165	210
Mounting pitch	$P_1 \times P_2$	mm	105x25	150x25	195x25
Stroke	S	mm	100~1550 (Take 50 mm as increase unit)		
Clamping length	L_1	mm	50 (Stroke=100 mm~700 mm) 70 (Stroke=750 mm~1300 mm) 100 (Stroke=1350 mm~1550 mm)		
Total stator length	L_s	mm	$L_s(\text{Total stator length})=S(\text{Stroke})+L_f(\text{Length of forcer})+2*L_1(\text{Clamping length})$		

Note: 1. Values in the table refer to operation without forced cooling.
2. Except dimensions, the electrical specifications are in $\pm 10\%$ of tolerance.
3. We reserve the right of changes, please follow customer recognition drawings.

Force and velocity curve(DC bus voltage = 325 V_{DC})

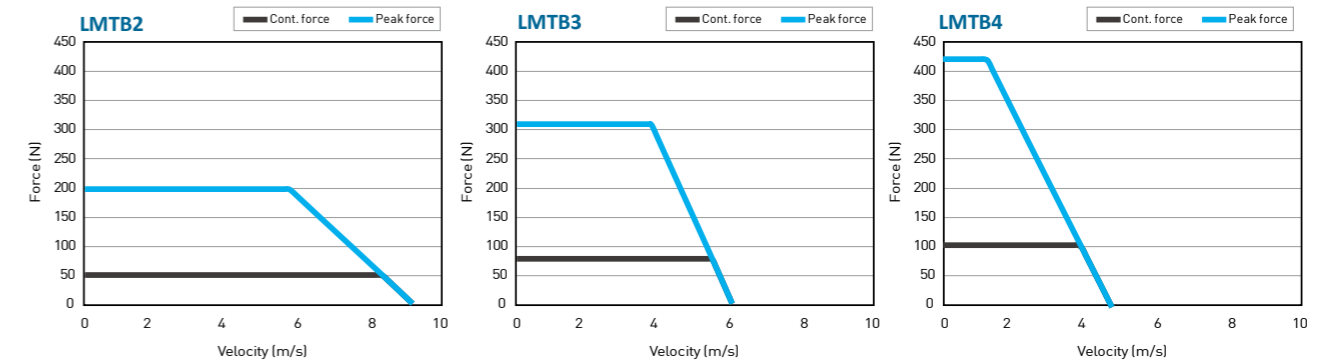

Dimensions of LMTB forcers and stators

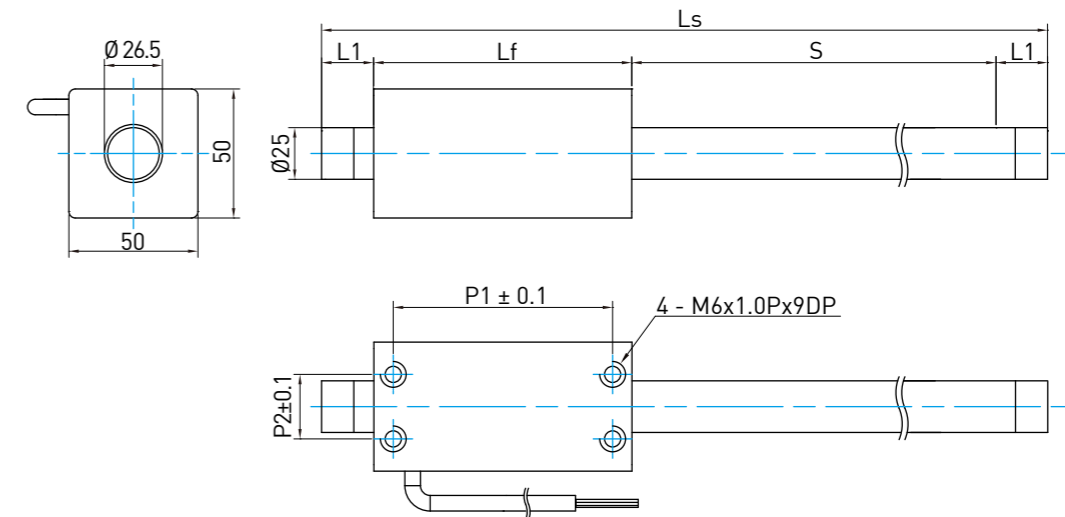

2.5.6 LMTC series

Table 2-19 LMTC series specifications

	Symbol	Unit	LMTC2	LMTC3	LMTC4	LMTC5	LMTC6
Continuous force	F_c	N	99	151	200	250	299
Continuous current	I_c	A_{rms}			2.6		
Peak force (1s)	F_p	N	395	603	801	998	1196
Peak current (1s)	I_p	A_{rms}			10.4		
Force constant	K_f	N/A_{rms}	38	58	77	96	115
Electrical time constant	K_e	ms			1.2		
Resistance (line to line · 25°C)	R_{25}	Ω	6.2	9.3	12.4	14.5	17.4
Inductance (line to line)	L	mH	7.2	10.8	14.7	17.3	20.7
Pole pair pitch	2τ	mm			120		
Minimum bending radius of cable	R_{bend}	mm			37.5		
Back emf constant (line to line)	K_v	$V_{rms}/(m/s)$	24.6	36.9	49.2	61.5	73.8
Motor constant(25°C)	K_m	N/\sqrt{W}	12.5	15.5	17.9	20.6	22.5
Thermal resistance	R_{TH}	$^{\circ}C/W$	1.1	0.7	0.6	0.4	0.3
Thermal switch					PTC		
Maximum DC bus voltage		V_{DC}			325		
Mass of forcer	M_f	kg	1.5	2.1	2.8	3.4	4.0
Unit mass of stator	M_s	kg/m			6.4		
Length of forcer	L_f	mm	160	220	280	340	400
Mounting pitch	$P_1 \times P_2$	mm	140x30	200x30	260x30	320x30	380x30
Stroke	S	mm	100~2000 (Take 50 mm as increase unit)				
Clamping length	L_1	mm	50 (Stroke=100 mm~750 mm) 70 (Stroke=800 mm~1500 mm) 100 (Stroke=1550 mm~2000 mm)				
Total stator length	L_s	mm	$L_s(\text{Total stator length})=S(\text{Stroke})+L_f(\text{Length of forcer})+2*L_1(\text{Clamping length})$				

Note:1.Values in the table refer to operation without forced cooling.
2.Except dimensions, the electrical specifications are in $\pm 10\%$ of tolerance.
3. We reserve the right of changes, please follow customer recognition drawings.

Force and velocity curve(DC bus voltage = 325 V_{DC})

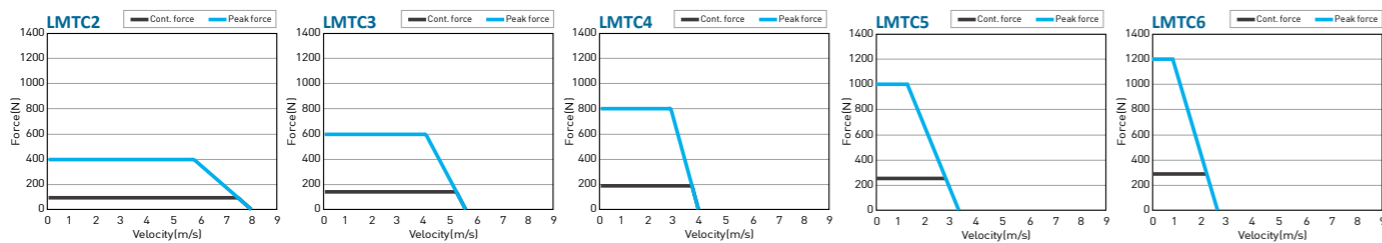

Dimensions of LMTC forcers and stators

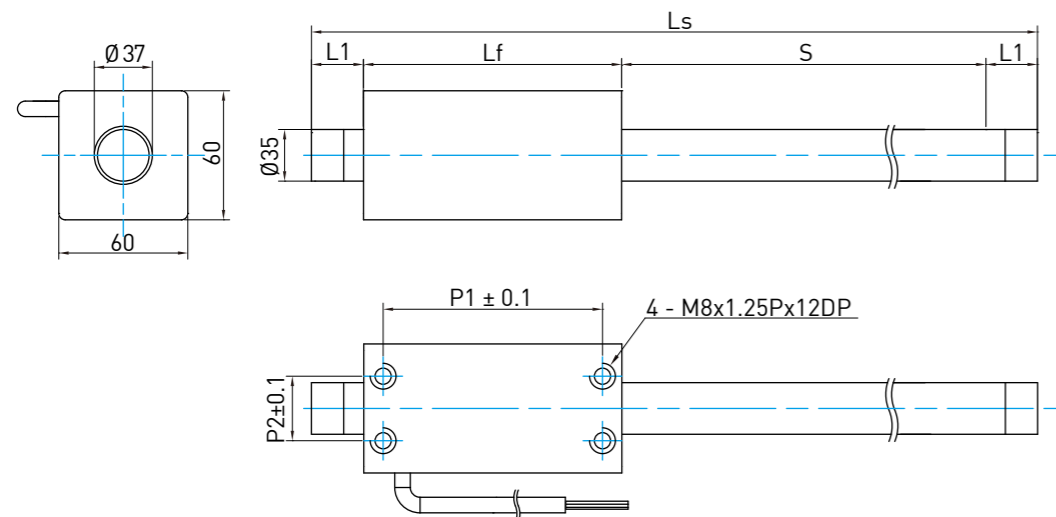

2.5.7 LMTD series

Table 2-20 LMTD series specifications

	Symbol	Unit	LMTD2	LMTD3	LMTD4
Continuous force	F_c	N	137	205	274
Continuous current	I_c	A_{rms}		1.9	
Peak force (1s)	F_p	N	548	820	1096
Peak current (1s)	I_p	A_{rms}		7.6	
Force constant	K_f	N/A_{rms}	72	108	144
Electrical time constant	K_e	ms		3.4	
Resistance (line to line · 25°C)	R_{25}	Ω	18.5	27.8	37.0
Inductance (line to line)	L	mH	62	93	124
Pole pair pitch	2τ	mm		180	
Minimum bending radius of cable	R_{bend}	mm		37.5	
Back emf constant (line to line)	K_v	$V_{rms}/(m/s)$	44	66	88
Motor constant(25°C)	K_m	N/\sqrt{W}	13.7	16.8	19.4
Thermal resistance	R_{TH}	$^{\circ}C/W$	0.7	0.5	0.4
Thermal switch				PTC	
Maximum DC bus voltage		V_{DC}		325	
Mass of forcer	M_f	kg	3.9	5.9	7.8
Unit mass of stator	M_s	kg/m		7.4	
Length of forcer	L_f	mm	220	310	400
Mounting pitch	$P_1 \times P_2$	mm	200x50	290x50	380x50
Stroke	S	mm	100~2000 (Take 50 mm as increase unit)		
Clamping length	L_1	mm	60 (Stroke=100 mm~550 mm) 80 (Stroke=600 mm~1000 mm) 100 (Stroke=1050 mm~2000 mm)		
Total stator length	L_s	mm	$L_s(\text{Total stator length})=S(\text{Stroke})+L_f(\text{Length of forcer})+2*L_1(\text{Clamping length})$		

Note:1.Values in the table refer to operation without forced cooling.
2.Except dimensions, the electrical specifications are in $\pm 10\%$ of tolerance.
3. We reserve the right of changes, please follow customer recognition drawings.

Force and velocity curve(DC bus voltage = 325 V_{DC})

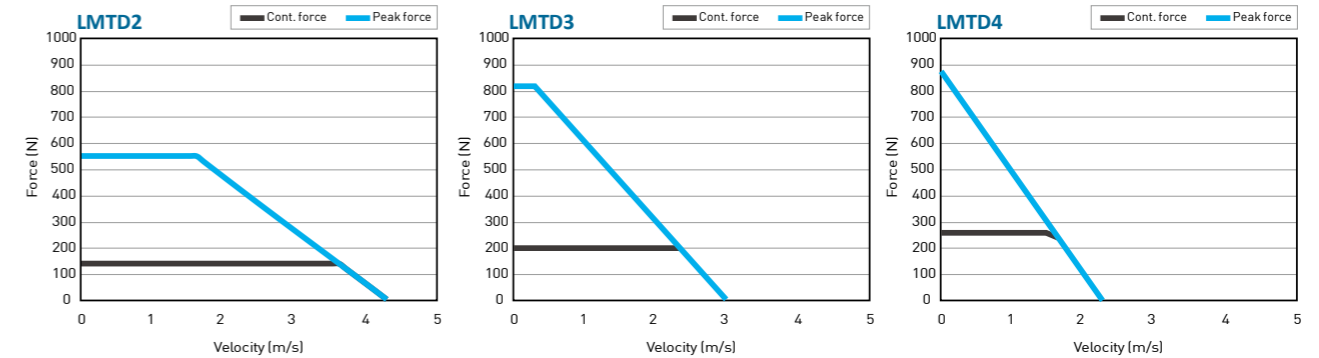

Dimensions of LMTD forcers and stators

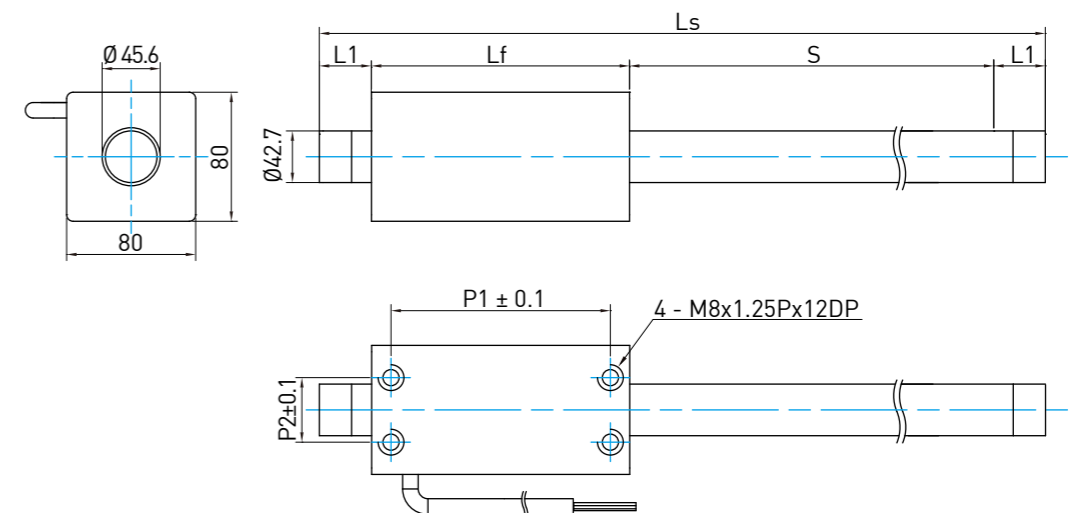

2.5.7 LMTE series

Table 2-21 LMTE series specifications

	Symbol	Unit	LMTE2	LMTE3	LMTE4
Continuous force	F_c	N	321	480	642
Continuous current	I_c	A_{rms}	7.7	11.5	15.4
Peak force (1s)	F_p	N	1284	1918	2569
Peak current (1s)	I_p	A_{rms}	30.8	46.0	61.6
Force constant	K_f	N/A_{rms}		41.7	
Electrical time constant	K_e	ms		6.5	
Resistance (line to line · 25°C)	R_{25}	Ω	1.8	1.2	0.9
Inductance (line to line)	L	mH	12	8	6
Pole pair pitch	2τ	mm		180	
Back emf constant (line to line)	K_v	$V_{rms}/(m/s)$		24.4	
Motor constant(25°C)	K_m	N/\sqrt{W}	25.1	30.7	35.5
Thermal resistance	R_{TH}	$^{\circ}C/W$	0.4	0.3	0.2
Thermal switch				PTC	
Maximum DC bus voltage		V_{DC}		325	
Mass of forcer	M_f	kg	7.8	11.3	14.7
Unit mass of stator	M_s	kg/m		12.5	
Length of forcer	L_f	mm	210	300	390
Mounting pitch	$P_1 \times P_2$	mm		90x90	
Stroke	S	mm	100~1000 (Take 50 mm as increase unit)		
Clamping length	L_1	mm	100(Stroke=1050 mm~2000)		
Total stator length	L_s	mm	$L_s(\text{Total stator length})=S(\text{Stroke})+L_f(\text{Length of forcer})+2*L_1(\text{Clamping length})$		

Note:1.Values in the table refer to operation without forced cooling.
2.Except dimensions, the electrical specifications are in $\pm 10\%$ of tolerance.
3. We reserve the right of changes, please follow customer recognition drawings.

Order code of magnet track (stator)

Series	Diameter of stator	Model	Width of stator
LMT	A	S	<input type="checkbox"/> <input type="checkbox"/> <input type="checkbox"/> <input type="checkbox"/>
	8: 8 mm	S: Standard	
	2: 12 mm	C: Customized	
	6: 16 mm		
	A: 20 mm		
	B: 25.4 mm		
	BS: 25 mm		
	C: 35 mm		
	D: 42.7 mm		
	E: 50 mm		

Force and velocity curve(DC bus voltage = 325 V_{DC})

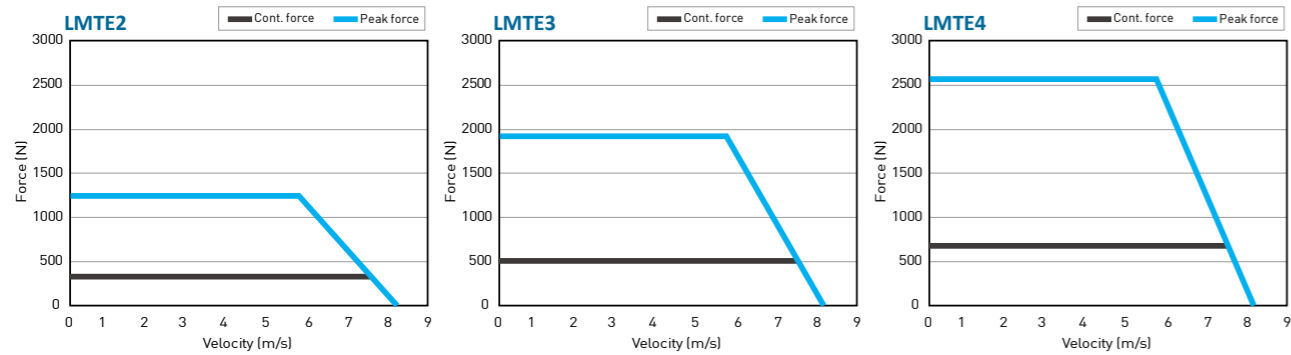

Dimensions of LMTE forcers and stators

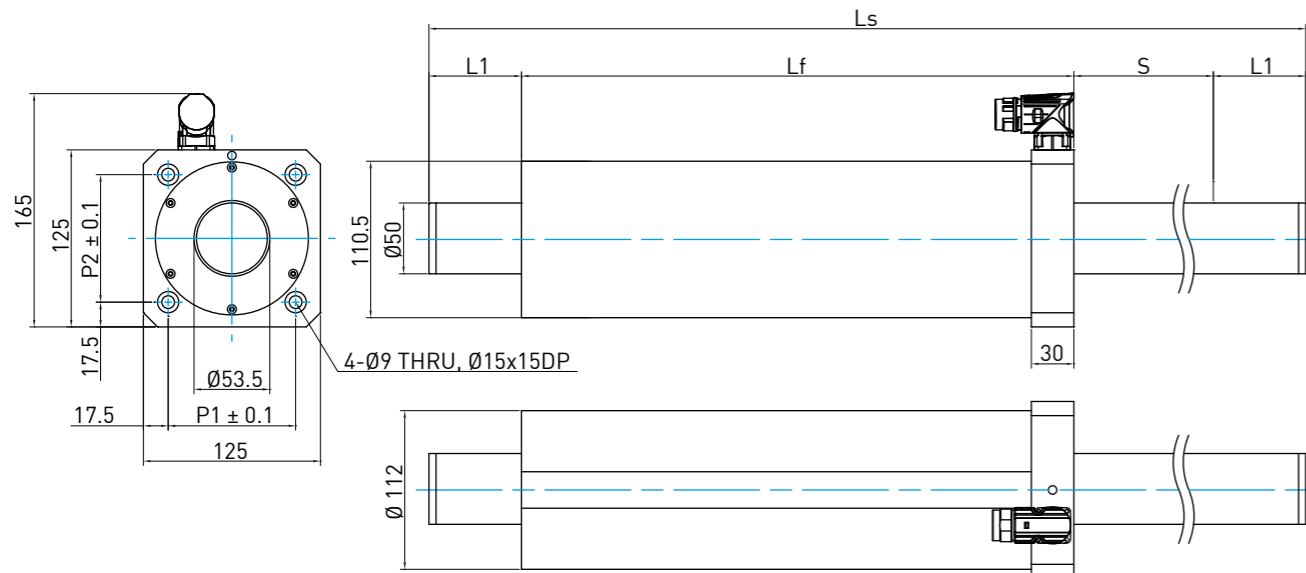

3 Drive

3.1 D1 Servo drive

- Digital drive
- Vector control
- Lightening human-machine interface
- 100-240VAC power input
- Support all kinds of pulse wave formats
- Support analog or digital optical rulers



3.1.1 Drive related accessories

Table3-1 Drive peripheral accessories

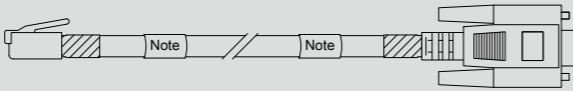
Name	Specification	Connector	Description
RS-232 communication wire	LMACR21D	D-sub connector and CN1	D-Sub9PIN to RJ-11 
	050100700001		Rated power is 100W, instant power is 500W
D1 drive connector kit	D1-CK1		All connectors (without CN3 connector)
	D1-CK2		All connectors (also includes CN3 connector)
EMC package	D1-EMC1		Single-phase power supply
	D1-EMC2		Three-phase power supply
Heat sink	D1-H1		Standard
	D1-H2		Small type
Digital Hall Sensor	LMAHC		Suitable for LMCA,LMCB and LMCC series,single-ended signals
	LMAHC2		Suitable for LMCD and LMCE series,single-ended signals
	LMAHC3		Suitable for LMCF series,single-ended signals
	LMDHTA		Suitable for LMTA series,single-ended signals
	LMDHTB		Suitable for LMTB series,single-ended signals
	LMDHTC		Suitable for LMTC series,single-ended signals
	LMAHSA	9PIN D type connector	Suitable for all LMSA series
	LMAHSA-W	Scattered wires	Suitable for all LMSA series
	LMAHF1	9PIN D type connector	Suitable for LMFA0-2 series
	LMAHF2	9PIN D type connector	Suitable for LMFA3-6 series
Analog Hall Sensor	LMAHF1-W	Scattered wires	Suitable for LMFA0-2 series
	LMAHF2-W	Scattered wires	Suitable for LMFA3-6 series
	LMAHCA-D		Suitable for LMCA,LMCB and LMCC series,differential signals
	LMAHSA-D	Scattered wires	Suitable for all LMSA series
	LMAHFA1-D	Scattered wires	Suitable for LMFA0-2 series
	LMAHFA2-D	Scattered wires	Suitable for LMFA3-6 series

Note: for Hall sensor accessories, if necessary, please contact HIWIN MIKROSYSTEM.

3.1.2 D1 drive related wires

Table3-2 Control signals, limit signals, motor power wires



Name	Specification	Connector	Description
Control signal wires	LMACK30R	CN2	To motion controller (about 3 meters long).  Drive connector(3M) Model : 10126-3000VE
Limit switch extension cable	LMACK□□S		Suitable for linear motor positioning platform.  D-Sub9Pin to scattered wires
	LMACS□□D		Suitable for LMSA series linear motor, LMC series linear motor LMC-EFE, LMC-EFF.  9W4S to loose wires & over temperature wire connector
Motor power wires and over temperature signal wires	LMACS□□L		Suitable for LMCF series linear motor.  9W4S to loose wires & over temperature wire connector
	LMACS□□K		Suitable for LMC series motor: A, B, C, D, E, F, EFC, HUB, LMT series linear motor: A, B, C, D.  Intercontec to scattered wires & over temperature wire connector
	LMACS□□P		Suitable for LMT series linear motor: E.  Intercontec to scattered wires & over temperature wire connector
	LMACS□□A	Motor power connector (U.V.W)	Suitable for LMFA series linear motor: LMFA0□□、LMFA1□□、LMFA2□□、LMFA31、LMFA31L、LMFA32、LMFA32L、LMFA41、LMFA41L、LMFA42、LMFA42L、LMFA52、LMFA52L、LMFA62[round metal connector, wire diameter 2.5mm ²] 
	LMACS□□C		Suitable for LMFA series linear motor: LMFA33、LMFA33L、LMFA34、LMFA43、LMFA43L、LMFA44、LMFA53、LMFA53L、LMFA54、LMFA62L、LMFA63、LMFA64 included KTY and PTC two sets of over temperature signals (two sets of over temperature signals 4.0mm ²) 
	LMACS□□X		Suitable for LMFA series linear motor: LMFA34L、LMFA44L、LMFA54L、LMFA63L included KTY and PTC two sets of over temperature signals (two sets of over temperature signals 4.0mm ²) 
	LMACS□□Y		Suitable for LMFA series linear motor: LMFA64L included KTY and PTC two sets of over temperature signals (two sets of over temperature signals 6.0mm ²) 

Table3-3 Position feedback wires

Drive	Specification	Connector	Description
HIWIN D1-XX-S2 series	LMACE□□Y	CN3	For Renishaw digital optical ruler, motor over temperature signal. Position feedback connector D-SUB 15 female  Drive connector(3M) Type:10120-3000VE
	LMACE□□Z		For Renishaw digital optical ruler, motor over temperature signal, digital Hall component signals. Position feedback connector D-SUB 15 female  Digital Hall component connector D-SUB 15 female Drive connector(3M) Type:10120-3000VE
	LMACE□□C		For Renishaw analog optical ruler, motor over temperature signal. Position feedback connector D-SUB 15 female  Drive connector(3M) Type:10120-3000VE
	LMACE□□J		For Renishaw analog optical ruler, motor over temperature signal, digital Hall component signals. Position feedback connector D-SUB 15 female  Digital Hall component connector D-SUB 15 female Drive connector(3M) Type:10120-3000VE
	HIWIN D1-XX-S3 series		LMACE□□AW
LMACE□□AV		For Renishaw digital optical ruler , motor over temperature signal, digital Hall component signals. 	

□□	03	04	05	06	07	08	09	10
Cable length (m)	3	4	5	6	7	8	9	10

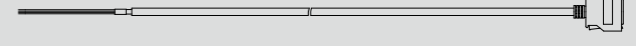
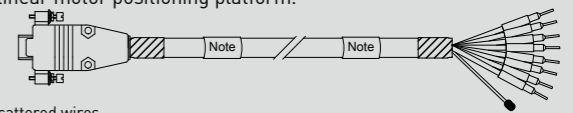
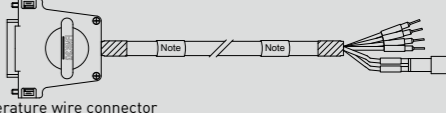
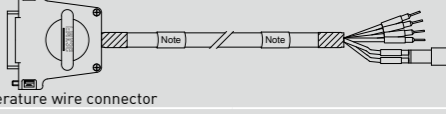
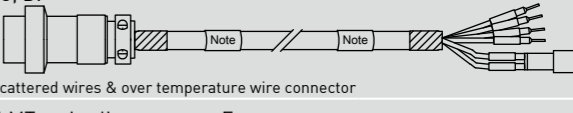
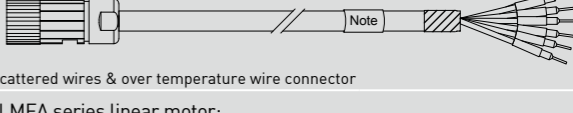
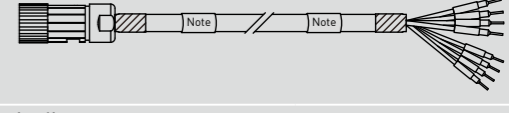
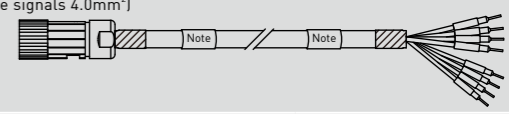
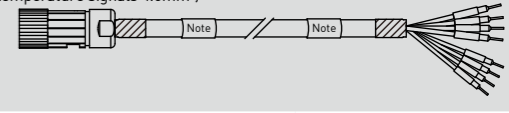
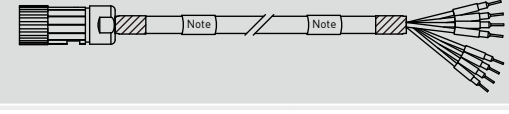
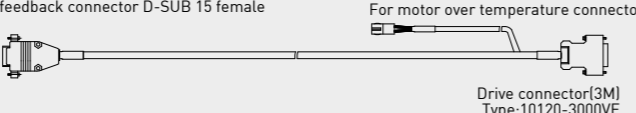
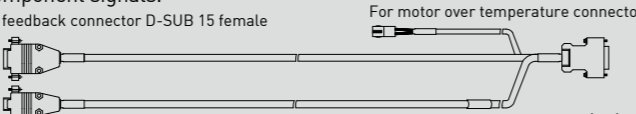
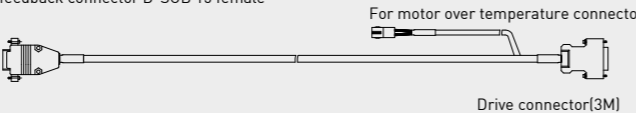
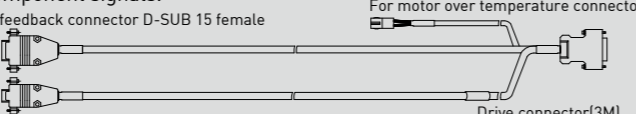
3.1.3 Pin assignments of D1

LMACE□□Z
LMACE□□Y (No Hall component)

Signal	D-SUB 15Pin female connector	Color (051400300063)	D-SUB 20Pin male connector
5V	7	Brown	3
0V	2	White	2
A+	14	Green	4
A-	6	Yellow	5
B+	13	Blue	6
B-	5	Red	7
Z+	12	Violet	8
Z-	4	Grey	9
Inner Shield	15	Inner shield	20
Case	-	Outer shield	1

Signal	2Pin female connector	Color (051400300133)	
T+	1	Brown	14
T-	2	Blue	15

Signal	D-SUB 9Pin female connector	Color (051400100075)	
5V	1	Brown	3
Hall A	2	White	11
Hall B	3	Grey	12
Hall C	4	Yellow	13
0V	5	Green	10
Shield	Case	Shield	1

LMACE□□AV
LMACE□□AW (No Hall component)

Signal	D-SUB 15Pin female connector	Color (051400300069)	D-SUB 20Pin male connector
5V	7	Brown	3
0V	2	White	2
A+	14	Green	4
A-	6	Yellow	5
B+	13	Blue	6
B-	5	Red	7
Z+	12	Violet	8
Z-	4	Gray	9
Encoder Alarm	3	Pink	18
Inner	15	Inner shield	20
Outer	Case	Outer shield	1

Signal	2Pin female connector	Color (051400100133)	
T+	1	Brown	14
T-	2	Blue	15

Signal	D-SUB 9Pin female connector	Color (051400100075)	
5V	1	Brown	3
Hall A	2	White	11
Hall B	3	Grey	12
Hall C	4	Yellow	13
0V	5	Green	10
Shield	Case	Shield	1

LMACE□□J
LMACE□□C (No Hall component)

Signal	D-SUB 15Pin female connector	Color (051400300063)	D-SUB 20Pin male connector
5V	4	Brown	3
0V	12	White	2
Sin(+)	9	Green	16
Sin(-)	1	Yellow	17
Cos(+)	10	Blue	18
Cos(-)	2	Red	19
Z+	3	Violet	8
Z-	11	Grey	9
Inner Shield	15	Inner shield	20
Case	-	Outer shield	1

Signal	2Pin female connector	Color (051400100133)	
T+	1	Brown	14
T-	2	Blue	15

Signal	D-SUB 9Pin female connector	Color (051400100075)	
5V	1	Brown	3
Hall A	2	White	11
Hall B	3	Grey	12
Hall C	4	Yellow	13
0V	5	Green	10
Shield	Case	Shield	1

LMACK30R

Signal	Pin	Color	Wire pair	Color	Pin	Signal
Frame Ground	1	Brown	1a 8a	Blue	14	[Out2]
Signal Ground	2	Brown/White	1b 8b	Blue/White	15	[Out3]
Enable [IN1]	3	Red	2a 9a	Light blue	16	Encoder A In/Out
GP Input [IN2]	4	Red/Black	2b 9b	Light blue /Black	17	Encoder /A In/Out
GP Input [IN3]	5	Orange	3a 10a	Purple	18	Encoder B In/Out
GP Input [IN4]	6	Orange/Black	3b 10b	Purple /White	19	Encoder /B In/Out
HS Input [IN6]	7	Green	6a 11a	Grey	20	Encoder X In/Out
HS Input [IN7]	8	Pink	4a 11b	Grey /Black	21	Encoder /X In/Out
HS Input [IN8]	9	Yellow	5a 12a	White/Red	22	+5 Vdc @ 400mA
HS Input [IN9]	10	Pink/Black	4b 12b	White/Blue	23	Signal Ground
HS Input [IN10]	11	Yellow/Black	5b 13a	White	24	Analog Ref In (+)
GP Input [IN11]	12	Green/Black	6b 13b	White /Black	25	Analog Ref In (-)
[Out1]	13	Light green	7a 7b	Light green/Black	26	[IN12] GP Input
Shield	Case					

NOTE: Wire pair 1a and 1b represent diagonal.

LMACK□□□

Signal	Pin	Color	Marker tube
Vcc	1	Yellow	+
GND	9	Green	-
Negative limit signal output	3	Grey	1-OUT
* Reference notes	2	White	1-L
Positive limit signal output	5	Pink	2-OUT
* Reference notes	4	Brown	2-L
Near home sensor signal output	7	Red	3-OUT
* Reference notes	6	Blue	3-L

NOTE: If connect wire set "L" to "+", can change wire set "OUT" output contact patterns.

3.2 D1 - N Servo Drive

- Current vector control
- Best for driving linear motors, shaft motors and torque motors
- 100-240VAC power input
- Supports STP / DIR, CW / CCW, A / B pulse formats (differential / single ended interace)
- supports ±10V voltage or digital commands for velocity or force/ torque modes
- PDL general motion language
- Supports analog and digital encoder and resolver



3.2.1 D1-N related accessories

Table3-4 Drive peripheral accessories

Name	Specification	Connector	Description
USB 2.0A to Mini-B Cable (5m)			051700800514
Regenerative resistor	050100700001		Rated power 100W, instant power 500W
D1-N Drive connector accessories kit bag	D1-CK		All connectors
EMC accessories kit bag	D1-N EMC2		Single phase power
	D1-N EMC1		Three phase power

3.2.2 D1-N related cables

Table3-5 Control signals, limit signals, motor power cables



Name	Specification	Connector	Description
Control signal cables	LMACK□□F	X6	Both ends are scattered lines,suitable for HIWIN D1-N drive series. 
	LMACS□□U		Suitable for LMC series linear motors: LMC-EFE \ LMC-EFF 
Motor power supply cables and over-temperature signal cables	LMACS□□V		Suitable for LMSA motors 
	LMACS□□M		Suitable for LMC series linear motors: A, B, C, D, E, EFC LMT series linear motors: A, B, C, D 
	LMACS□□N		Suitable for LMC series linear motors:F 
	LMACT□□D		Suitable for LMT series linear motors:E 
	LMACS□□Z	X3	Suitable for LMFA series linear motors: LMFA0□□ \ LMFA1□□ \ LMFA2□□ \ LMFA31 \ LMFA31L \ LMFA32 \ LMFA32L \ LMFA41 \ LMFA41L \ LMFA42 \ LMFA42L \ LMFA52 \ LMFA52L \ LMFA62L[round metal connector, wire diameter 1.5mm ²) 
	LMACT□□A		Suitable for LMFA series linear motors: LMFA33 \ LMFA33L \ LMFA34 \ LMFA43 \ LMFA43L \ LMFA44 \ LMFA53 \ LMFA53L \ LMFA54 \ LMFA62L \ LMFA63 \ LMFA64,includes KTY and PTC two sets of over-temperature signals.[round metal connector, wire diameter 2.5mm ²) 
	LMACT□□B		Suitable for LMFA series linear motors: LMFA34L \ LMFA44L \ LMFA54L \ LMFA63L,includes KTY and PTC two sets of over-temperature signals.[round metal connector, wire diameter 4.0mm ²) 
	LMACS□□C		Suitable for LMFA series linear motors:LMFA64L,includes KTY and PTC two sets of over-temperature signals.[Round metal connector, wire diameter 6.0mm ²) 

Table3-6 Position feedback cables

Drive	Specification	Connector	Description
Suitable for linear motors	LMACF□□C	X10	For Renishaw digital optical scale,connector is the D-type connector,doesn't include Hall sensor signal. 
	LMACF□□D		For Renishaw digital optical scale,connector is the D-type connector, include Hall sensor signal. 
	LMACF□□A	X11	For Renishaw analog optical scale,connector is the D-type connector,doesn't include Hall sensor signal. 
	LMACF□□H		For Renishaw analog optical scale,connector is the D-type connector, include Hall sensor signal. 

3.2.3 Pin assignments of D1-N

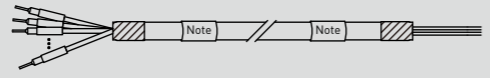
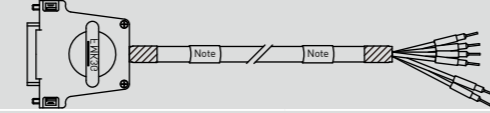
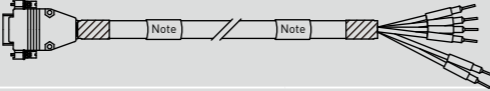
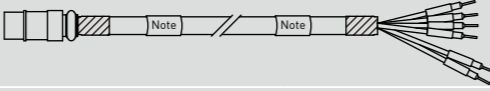
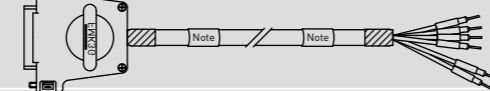
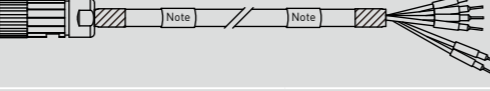
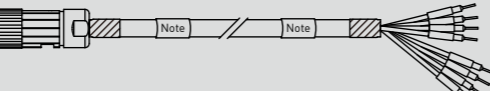
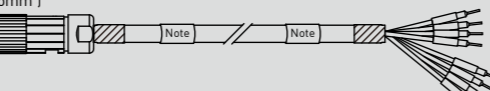
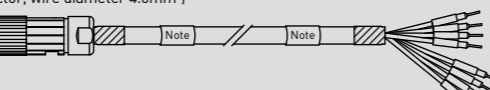
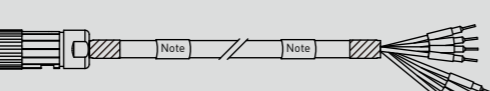
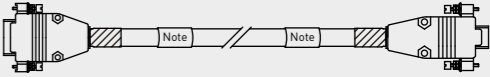
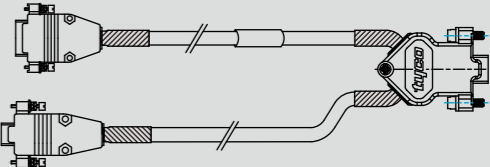
LMACF□□□□
LMACF□□□□ (No Hall component)

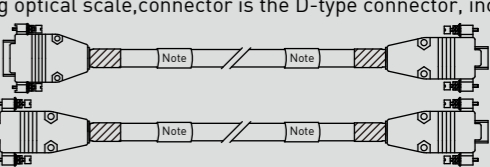
Signal	D-SUB 15Pin female connector	Color (051400300069)	X10HD-SUB 15Pin male connector
5V	7	Brown	5
	8	Brown/Yellow	
0V	2	White	15
	9	White/Yellow	
A+	14	Green	1
A-	6	Yellow	6
B+	13	Blue	2
B-	5	Red	7
Z+	12	Violet	3
Z-	4	Grey	8
Inner Shield	15	Inner shielding	15
Outer	Case	Outer shielding	Case

Signal	9Pin female connector	Color (051400100075)
5V	1	Brown
Hall A	2	White
Hall B	3	Grey
Hall C	4	Yellow
0V	5	Green
Shield	Case	Shield

LMACE□□□□H
LMACE□□□□A (No Hall component)

Signal	D-SUB 15Pin female connector	Color (051400300069)	X11HD-SUB 15Pin male connector
5V	4	Brown	5
	5	Brown/Yellow	
0V	12	White	15
	13	White/Yellow	
Sin(+)	9	Green	1
Sin(-)	1	Yellow	6
Cos(+)	10	Blue	2
Cos(-)	2	Red	7
Z+	3	Violet	3
Z-	11	Grey	8
Inner Shield	15	Inner shielding	15
Outer	Case	Outer shielding	Case

Signal	D-SUB 9Pin female connector	Color (051400100075)
5V	1	Brown
Hall A	2	White
Hall B	3	Grey
Hall C	4	Yellow
0V	5	Green
Shield	Case	Shield

LMACK□□□□

Signal	Pin	Color	Signal	Pin	Color
CWL	1	White	FG	21	Light blue
CCWL	2	White/Black	GND	22	Light blue/Black
CW+	3	Red	01+	23	Light green
CW-	4	Red/Black	01-	24	Light green /Black
CCW+	5	Yellow	02+	25	White/Red
CCW-	6	Yellow/Black	02-	26	White/Blue
I1	7	Green	03+	27	Red/White
I2	8	Green/Black	03-	28	Red/Blue
I3	9	Blue	PT+	29	Yellow/Red
I4	10	Blue/White	PT-	30	Yellow/Blue
I5	11	Brown	N/A	31	Green/White
I6	12	Brown/White	N/A	32	Light green /Blue
I7	13	Orange	A	33	Gray/Red
I8	14	Orange/Black	/A	34	Gray/Blue
I9	15	Gray	B	35	Pink/Red
I10	16	Gray/Black	/B	36	Pink/Blue
COM	17	Purple	Z	37	Light blue/Red
REF+	18	Pink	/Z	38	Light blue/Blue
REF-	19	Pink/Black	CZ	39	Light green /Red
DSF+	20	Violet/White	DSF-	40	Green/Blue

Appendix A: Motor Sizing

Start Motor Sizing

The following contents describe how to choose proper motor according to velocity, stroke, and loading. The basic process for sizing a motor is:

- Decide motion profile and required parameters
- Calculate peak and continuous force
- Select motor

Symbols

X : stroke (m)
 T : cycle time (sec)
 a : acceleration (m/s²)
 V : velocity (m/s)
 M_L: loading (kg)
 g : gravitation acceleration (m/s²)
 F_p: peak force (N)
 F_c: continuous force (N)
 F_a: attraction force between stator and forcer (N)
 F_i: inertia force (N)
 K_f: force constant (N/Arms)
 I_p: peak current (Arms)
 I_e: effective current (Arms)
 I_c: continuous current (Arms)
 V₀: starting velocity (mm/s)

STEP 1 Decide motion velocity profile and required parameters

In order to determine the correct motor for a particular application it is necessary to be familiar with the motion equation.

Motion equation

Basic kinematics equations are described as follows:

$$V = V_0 + aT$$

$$X = V_0T + \frac{1}{2}aT^2$$

Where V is velocity, a is acceleration, T is cycle time and X is stroke.

You can choose two of the four parameters (V, a, T and X) as your designed parameters, then the last two parameters can be calculated by above equations.

Motion velocity profile

1. 1/3-1/3-1/3 trapezoid profile

If X and T have been given, the most common and efficient velocity profile for point-to-point motion is the "1/3-1/3-1/3" trapezoid curve because it provides the optimal move by minimizing the power required to complete the move. It breaks the time of the acceleration, constant, and deceleration into three segments as shown below.

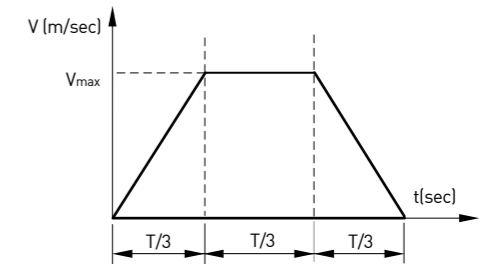

$$V_{max} = 1.5 \times \frac{X}{T} \quad (\text{Because } X = \frac{V}{2} \times \frac{T}{3} + V \times \frac{T}{3} + \frac{V}{2} \times \frac{T}{3})$$

$$a_{max} = \frac{V_{max}}{T/3} = \frac{4.5X}{T^2}$$

Herein the parameters are described as motion equation.

2. 1/2-1/2 triangle profile

If X and T are given, another common motion profile is the 1/2-1/2 triangle profile. The motion is divided into two parts, namely acceleration and deceleration. The second motion velocity profile is shown as follows.

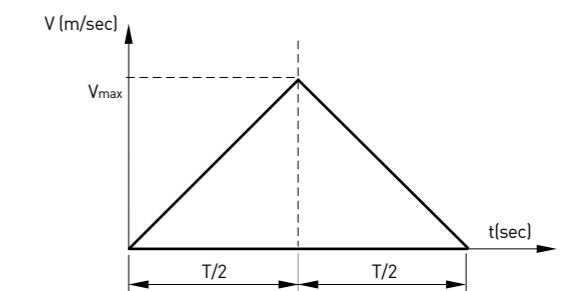

$$V_{max} = 2 \times \frac{X}{T}$$

$$a_{max} = \frac{4X}{T^2}$$

The acceleration required in the first motion velocity profile is bigger than that in the second motion velocity profile; therefore, the required motor size is bigger. When choosing second motion velocity profile, the chosen motor size is smaller, however, we need to verify the DC bus of drive is bigger enough, due to the higher velocity (V_{max}).

3. Some useful equations

	<p>1/3 -1/3-1/3 Trapezoid profile</p>	<p>Triangle profile</p>
V	$1.5 \times \frac{X}{T}$	$2 \times \frac{X}{T}$, or $\sqrt{a \times X}$
a	$\frac{4.5X}{T^2}$	$\frac{4X}{T^2}$
t	$\frac{X}{V_{max}} + \frac{V_{max}}{a}$ (if $\frac{X}{V_{max}} \geq \frac{V_{max}}{a}$)	

STEP 2 Determine peak force and effective force

The peak force can be calculated by the follow equation

$$F_p = M_L \times a_{max} + (M_L \times g + F_a) \times \mu = F_i + F_f$$

Where F_i is inertia force while F_f is friction force, and μ is friction factor.

In most cases, motions are cyclic point-to-point movements. Assuming a cyclic motion shown in the following profile with a pause time of t_4 second, the effective force can be calculated as following formula:

$$F_e = \sqrt{\frac{(F_i + F_f)^2 t_1 + F_f^2 t_2 + (F_i - F_f)^2 t_3}{t_1 + t_2 + t_3 + t_4}}$$

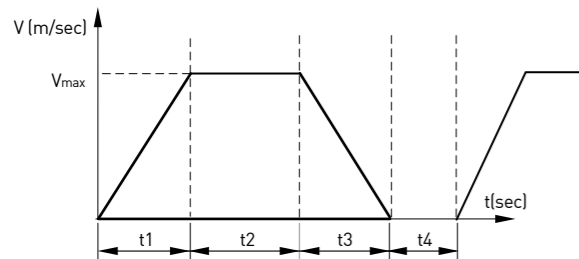

The peak current I_p and effective current I_e can be calculated by using motor force constant K_f .

$$I_p = \frac{F_p}{K_f}$$

$$I_e = \frac{F_e}{K_f}$$

STEP 3 Select motor by peak force and verify the current supply of motor

From the catalog of HIWIN, you can check the specifications of motor and choose an applicable motor by peak force, and then you can verify the current supply if it is fitted the specification as follows.

$$I_p = \frac{F_p}{K_f} < I_p \text{ (motor specification)}$$

$$I_e = \frac{F_e}{K_f} < I_c \text{ (motor specification)}$$

Regarding effective and continuous current, the ratio of I_e/I_c had better be less than 0.7 to attain some margin.

Linear Motor Sizing Example

For example, if load is 5 kg (moving mass of mechanism is 1 kg and payload is 4 kg), friction factor μ is 0.01, stroke is 500 mm, moving time is 400 ms and dwell time is 350 ms.

At first, we can calculate the V_{max} , a_{max} , F_p and F_e by the formulas described above (choose the first motion velocity profile and LMC series)

$$V_{max} = 1.5 \times \frac{X}{T} = 1.5 \times \frac{0.5}{0.4} = 1.875 \text{ (m/sec)}$$

$$a_{max} = \frac{4.5 \times X}{T^2} = \frac{4.5 \times 0.5}{(0.4)^2} = 14.06 \text{ (m/sec}^2\text{)}$$

$$F_p = M_L \times a_{max} + (M_L \times g + F_a) \times \mu$$

$$= 5 \times 14.06 + 5 \times 9.81 \times 0.01 = 70.3 + 0.49 = 70.79 \text{ (N)}$$

$$F_e = \sqrt{\frac{[(70.3 + 0.49)^2 + 0.49^2 + (70.3 - 0.49)^2] \times 0.1333}{0.4 + 0.35}}$$

$$= 41.92 \text{ (N)}$$

In this case, we can choose motor of type LMCA6 (p.32) which can provide up to 248(N) of peak force and continuous force 62(N), and the force constant is 33.8 N/A(rms). Then the current supply of motor can be determined as follows

$$I_p = \frac{F_p}{K_f} = \frac{70.79}{33.8} = 2.09 \text{ (Arms)} < 7.2 \text{ (Arms)}$$

$$I_p = \frac{F_e}{K_f} = \frac{41.92}{33.8} = 1.24 \text{ (Arms)} < 1.8 \text{ (Arms)}$$

$$I_e/I_c = \frac{1.24}{1.8} \times 100\% = 68.89\% < 70\%$$

Appendix B: Sizing a Regen Resistor

1. Gather required information

To calculate the power and resistance of the regen resistor requires information about the amplifier and the motor.

For all applications, gather the following information:

- Detail of motion profile, including acceleration and velocity
- Amplifier model number
- Applied line voltage to amplifier
- Torque/force constant of the motor
- Resistance (line-to-line) of the motor windings

For rotary motor applications, gather additional information

- Load inertia seen by the motor
- Inertia of the motor

For linear motor applications, gather additional information

- Moving mass

2. Observe the properties of each deceleration during a complete cycle of operation

For each deceleration during the motion cycle, determine:

- Speed at the start of the deceleration
- Speed at the end of the deceleration
- Time over which the deceleration takes place

3. Calculate energy returned for each deceleration

The energy returned during each deceleration can be calculated by the following formulas.

Rotary motor:

$$E_{\text{dec}} = \frac{1}{2} J_t (\omega_1^2 - \omega_2^2)$$

E_{dec} (joules): Energy returned by the deceleration

J_t (kg m^2): Load inertia on the motor shaft plus the motor inertia

ω_1 (radians/sec): Shaft speed at the start of deceleration

ω_2 (radians/sec): Shaft speed at the end of deceleration

I_e : effective current (Arms)

Linear motor:

$$E_{\text{dec}} = \frac{1}{2} M_t (V_1^2 - V_2^2)$$

E_{dec} (joules): Energy returned by the deceleration

M_t (kg): Moving mass

V_1 (meters/sec): Velocity at the start of deceleration

V_2 (meters/sec): Velocity at the end of deceleration

4. Determine the amount of energy dissipated by the motor

Calculate the amount of energy dissipated by the motor due to current flow through the motor winding resistance using the following formula.

$$P_{\text{motor}} = \frac{3}{4} R_{\text{winding}} \left(\frac{F}{K_t} \right)^2$$

P_{power} (watts): Power dissipated in the motor

R_{winding} (ohm): Line to Line resistance of the motor coil

F : Force need to decelerate the motor

Nm for rotary applications

N for linear applications

K_t : Torque constant for the motor

Nm/Amp for rotary applications

N/Amp for linear applications

$E_{\text{motor}} = P_{\text{motor}} T_{\text{decel}}$

E_{motor} (joules): Energy dissipated in the motor

T_{decel} (seconds): Time of deceleration

5. Determine the amount of energy returned to the amplifier

Calculate the amount of energy that will be returned to the amplifier for each deceleration using the following formula

$E_{\text{returned}} = E_{\text{dec}} - E_{\text{motor}}$

E_{returned} (joules): Energy returned to the amplifier

E_{dec} (joules): Energy returned by the deceleration

E_{motor} (joules): Energy dissipated by the motor

6. Determine if energy returned exceeds amplifier capacity

Compare the amount of energy returned to the amplifier in each deceleration with the amplifier's absorption capacity. The following formula is used to determine the energy that can be absorbed by the amplifier.

$$W_{\text{capacity}} = \frac{1}{2} C (V_{\text{regen}}^2 - (1.414 V_{\text{mains}})^2)$$

W_{capacity} (joules): The energy that can be absorbed by the bus capacitor

C (farads): Bus capacitance

V_{regen} (volts): Voltage at which the regen circuit turns on

V_{mains} (volts): Mains voltage (AC) applied to the amplifier

7. Calculated energy to be dissipated for each deceleration

For each deceleration where the energy exceeds the amplifier's capacity, using the following formula to calculate the energy that must be dissipated by the regen resistor.

$E_{\text{regen}} = E_{\text{returned}} - E_{\text{amp}}$

E_{regen} (joules): Energy that must be dissipated in the regen resistor

E_{returned} (joules): Energy delivered back to the amplifier from the motor

E_{amp} (joules): Energy that the amplifier will absorb

8. Calculate pulse power of each deceleration that exceeds amplifier capacity

For each deceleration where energy must be dissipated by the regen resistor, use the following formula to calculate the pulse power that will be dissipated by the regen resistor

$P_{\text{pulse}} = E_{\text{regen}} / T_{\text{decel}}$

P_{pulse} (watts): Pulse power

E_{regen} (joules): Energy that must be dissipated in the regen resistor

T_{decel} (seconds): Time of deceleration

9. Calculate resistance needed to dissipate the pulse power

Using the maximum pulse power from the previous calculation, calculate the resistance value of the regen resistor required to dissipate the maximum pulse power.

$R = V_{\text{regen}}^2 / P_{\text{pulse max}}$

R (ohms): Resistance

$P_{\text{pulse max}}$: The maximum pulse power

V_{regen} : The voltage at which the regen circuit turns on

Choose a standard value of resistance less than the calculated value. The value must also be greater than the minimum regen resistor value specified by the amplifier supplier.

10. Regen resistor sizing example

Gather required information

LM ROBOTS type: LMXL1L-S37L-1200-G200

Amplifier: mega-fabs D1

DC bus capacitance: 1880uF

Regen circuit turn on voltage: 390V

Minimum resistance: 15Ω

Moving mass: 86Kg (include payload 74 Kg)

V_{max} : 2 m/s

Acceleration, deceleration: 5 m/s²

Power supply (AC) of drive: 220VAC

Motor type: LMS37L

Force constant (Kf): 68N/A(rms)

R_{winding} : 2 ohms(line-to-line)

Calculate regen resistor as following step:

$$F = ma = 86 \times 5 = 430 \text{ (N)}$$

$$E_{\text{dec}} = \frac{1}{2} m_t V^2 = \frac{1}{2} \times 86 \times 2^2 = 172 \text{ (joule)}$$

$$P_{\text{motor}} = \frac{3}{4} \times R_{\text{winding}} \times \left(\frac{F}{K_t} \times \sqrt{2} \right)^2 = \frac{3}{4} \times 2 \times \left(\frac{430}{68} \times \sqrt{2} \right)^2 = 120 \text{ (Watt)}$$

$$E_{\text{motor}} = P_{\text{motor}} \times T_{\text{decel}} = 120 \times \left(\frac{2}{5} \right) = 48 \text{ (joule)}$$

$$E_{\text{returned}} = E_{\text{dec}} - E_{\text{motor}} = 172 - 48 = 124 \text{ (joule)}$$

$$W_{\text{capacity}} = \frac{1}{2} \times C \times (V_{\text{regen}}^2 - (1.414 V_{\text{mains}})^2) = \frac{1}{2} \times 1880 \times 10^{-6} \times (390^2 - (1.414 \times 220)^2) = 51.98 \text{ (joule)}$$

$$\because E_{\text{returned}} > W_{\text{capacity}}$$

$$E_{\text{regen}} = E_{\text{returned}} - E_{\text{amp}} = 124 - 51.98 = 72.02 \text{ (joule)}$$

$$P_{\text{pulse}} = E_{\text{regen}} / T_{\text{decel}} = 72.02 / 0.4 = 180.05 \text{ (Watt)}$$





$$R = \frac{V_{\text{regen}}^2}{P_{\text{pulse}}} = \frac{390^2}{180.05} = 844.77 \text{ (ohms)}$$

Because the total value of selected resistance must be less than 844.77 ohms and the power capacity must be more than 180.05 watts, we choose two resistors and connect them in series, in each resistor the resistance is 68 ohms and power capacity is 100W. The total resistance value is 136 ohms and power capacity is 200W. The resistance order number is 050100700001.

Appendix C: Inquiry form

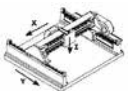
Fields marked with asterisk (*) are required.

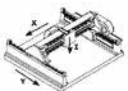
Date:

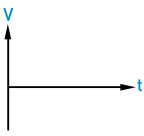
Customer name : _____		Contact HIWIN : _____		
Email : _____		Inquiry No. : _____		
Tel. : _____ Fax. : _____		Business owners : _____		
*Industry/Application	_____	Multi-forcers	<input type="checkbox"/> Yes, quantity : _____ pcs <input type="checkbox"/> No	
*Operational environment	<input type="checkbox"/> Indoor, general 25°C <input type="checkbox"/> Cleaning room, class : _____ <input type="checkbox"/> Vacuum , _____ <input type="checkbox"/> Others	Required measurement protocol	<input type="checkbox"/> Straightness(H) _____ μm <input type="checkbox"/> Straightness(V) _____ μm <input type="checkbox"/> Pitch _____ arc-sec <input type="checkbox"/> Yaw _____ arc-sec	
*Stage type	<input type="checkbox"/> Single <input type="checkbox"/> Dual axis Bridge <input type="checkbox"/> Gantry (single-driven) <input type="checkbox"/> Gantry (dual-driven) <input type="checkbox"/> Others _____	*Cover	<input type="checkbox"/> No <input type="checkbox"/> Metal cover <input type="checkbox"/> Bellows	
		Cable chain	<input type="checkbox"/> No <input type="checkbox"/> Horizontal <input type="checkbox"/> Vertical	
*Payload	<input type="checkbox"/> Mass : ___ kg <input type="checkbox"/> Dimensions : ___ mm <input type="checkbox"/> Offset, X : ___ mm, Y : ___ mm, Z : ___ mm	*Movement	<input type="checkbox"/> Point to point movement <input type="checkbox"/> Scanning	
		Firmware version	<input type="checkbox"/> Latest version <input type="checkbox"/> Specific version : _____	
External force (N)	X-axis Y-axis Z-axis _____	Drive	Voltage	<input type="checkbox"/> 110V <input type="checkbox"/> 220V <input type="checkbox"/> Other, _____ V
*Max. speed(m/s)	X-axis Y-axis Z-axis _____		command	<input type="checkbox"/> Pulse <input type="checkbox"/> STEP/DIR format <input type="checkbox"/> CW/CCW <input type="checkbox"/> A/B
*Max. acceleration(m/s ²)	X-axis Y-axis Z-axis _____			<input type="checkbox"/> Analog voltage command <input type="checkbox"/> Bus <input type="checkbox"/> mega-ulink <input type="checkbox"/> EtherCAT <input type="checkbox"/> Modbus
*Stroke(mm)	X-axis Y-axis Z-axis _____	Wiring board included	<input type="checkbox"/> Yes <input type="checkbox"/> No	
Repeatability(μm)	<input type="checkbox"/> Uni-dir. : ___ <input type="checkbox"/> Bi-dir. : ___	Software requirements	<input type="checkbox"/> Yes (Please fill in the remarks column) <input type="checkbox"/> No	
Accuracy(μm)	_____	Upper controller	<input type="checkbox"/> Specify	<input type="checkbox"/> Motion board
Encoder type(μm)	<input type="checkbox"/> Analog <input type="checkbox"/> Digital <input type="checkbox"/> Absolute : _____ Resolution : _____			Position trigger function
		<input type="checkbox"/> IPC		
*Stage installation	<input type="checkbox"/> Hang Axis : _____ 	Distance	_____ mm	<input type="checkbox"/> PLC
				<input type="checkbox"/> Customer provide
	<input type="checkbox"/> Vertical Axis : _____ 	Travel time	_____ sec	<input type="checkbox"/> HIWIN Design
		Dwelling time	_____ sec	
	<input type="checkbox"/> Upside-down Axis : _____ 	Motion profile		
		Others		
The information below is to be filled out by HIWIN or authorized agents. Recommended specification:				

Linear Motor Technical Information

Publication Date : June 2017, first edition

Print Date : June 2017, first edition

1. HIWIN is the registered trademark of HIWIN Mikrosystem Corp.. Please avoid buying the counterfeit goods that are from unknown sources to protect your rights.
 2. Actual products may be different from the specifications and photos in this catalog, and the differences in appearances or specifications may be caused by, among other things, product improvements.
 3. HIWIN will not sell or export those techniques and products restricted under the "Foreign Trade Act" and relevant regulations. Any export of restricted products should be approved by competent authorities in accordance with relevant laws, and shall not be used to manufacture or develop the nuclear, biochemical, missile and other military weapons.
-

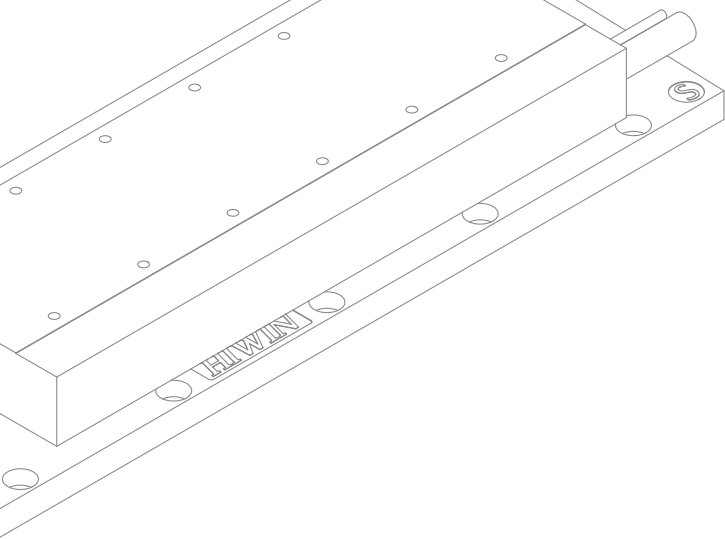

HIWIN®

Motion Control and System Technology

HIWIN MIKROSYSTEM CORP.

No.6, Jingke Central Rd.,
Taichung Precision Machinery Park,
Taichung 40852, Taiwan
Tel: +886-4-23550110
Fax: +886-4-23550123
www.hiwinmikro.tw
business@hiwinmikro.tw

Subsidiaries & R&D Centers

HIWIN GmbH
OFFENBURG, GERMANY
www.hiwin.de
www.hiwin.eu
info@hiwin.de

HIWIN JAPAN
KOBE · TOKYO · NAGOYA · NAGANO ·
TOHOKU · HOKURIKU · HIROSHIMA ·
KUMAMOTO · FUKUOKA, JAPAN
www.hiwin.co.jp
info@hiwin.co.jp

HIWIN USA
CHICAGO · SILICON VALLEY, U.S.A.
www.hiwin.com
info@hiwin.com

HIWIN Srl
BRUGHERIO, ITALY
www.hiwin.it
info@hiwin.it

HIWIN Schweiz GmbH
JONA, SWITZERLAND
www.hiwin.ch
info@hiwin.ch

HIWIN s.r.o.
BRNO, CZECH REPUBLIC
www.hiwin.cz
info@hiwin.cz

HIWIN SINGAPORE
SINGAPORE
www.hiwin.sg
info@hiwin.sg

HIWIN KOREA
SUWON, KOREA
www.hiwin.kr
info@hiwin.kr

HIWIN CHINA
SUZHOU, CHINA
www.hiwin.cn
info@hiwin.cn

Mega-Fabs Motion System, Ltd.
HAIFA, ISRAEL
www.mega-fabs.com
info@mega-fabs.com