

Control valve(3/2way)

M3 Series



Ordering code

Common type

M3 PM 210 06 R T



① Valve's type	② Model	③ Code	④ Port size	⑤ Button color	⑥ Thread type
M3: M type 3/2 Way	B: Basic type	110: 100 Series single control	06: 1/8"	No this code	T: NPT
	C: Long handle type				
	D: Short handle type				
	Y: Lever type				
	R: Roller type	210: 200 Series single control	06: 1/8" 08: 1/4"	R: Red	
	L: Roller with free return type				
	PL: Latching type			R: Red G: Green B: Black	
	PP: Protruding type				
	PF: Flat type				
	PM: Mushroom type				
HS: Selector type					

Mini type

M3 R 05



① Valve's type	② Model	③ Port size
M3: M type 3/2 Way	B: Basic type R: Roller type L: Roller with free return type	05: M5

Specification

Model	M3B	M3C	M3D	M3R	M3L	M3Y	M3PM	M3PP	M3PF	M3PL	M3HS
Fluid	Air (to be filtered by 40 μm filter element)										
Operating	External control direct acting type										
Port size [Note1]	05: M5 06: 1/8" 08: 1/4"										
Orifice size	Mini type	05: 2.5mm ² (Cv=0.14)									
	110	06: 8.0mm ² (Cv=0.45)									
	210	06: 9.0mm ² (Cv=0.50)					08: 12.0mm ² (Cv=0.67)				
Valve type	3/2 Way										
Lubrication [Note2]	Not required										
Pressure range	0~145psi(0~1.0MPa)										
Proof pressure	215psi(1.5MPa)										
Temperature	-20~70°C										
Material body	Aluminum alloy										

[Note1] NPT thread is available.

[Note2] Once lubricated air is used, continue with same medium to optimise valve life span.

It is suggested to use ISO VG32 lubricant or the oil with the same grade.

M3 Series

Product feature

1. Exhaust outlet locates over the body, which is convenient to install muffler to decrease noise and pollution.
2. The external force required by direction-change of series of M3B, M3R and M3L is provided by external mechanism, which can be used for position test or stroke switch limit switch.
3. M3C, M3D, M3Y, M3PF, M3PM, M3PP, M3PL and M3HS are operated manually, owning control joints with several structure forms and suitable for application under different conditions.
4. It is in sliding column structure that the control force is not influenced by working pressure (that is, there is no back pressure effect); internal circle is sealed with good tightness and the direction-change is sensitive.
5. No need to add oil for lubrication.
6. Multi-mounting makes it convenient to install and apply;
7. The control joints of series of M3C, M3D, M3Y, M3R, and M3L are made of metal which has long service life and more reliable and steady performance.

Reversal stroke

Unit:mm

Common type						Mini type		
Type	Spool stroke	Button stroke	Type	Spool stroke	Roller(handle) stroke	Type	Spool stroke	Roller stroke
M3B	2.0~3.3	-	M3R	2.0~3.0	4.6~6.8	M3B05	2.0~3.3	-
M3PF	2.0~3.3	3.8~5.1	M3L	2.0~3.0	5.0~7.8	M3R05	2.0~3.0	6.0~8.5
M3PP	2.0~3.3	3.8~5.1	M3C	2.0~3.0	11.0~16.0	M3L05	2.0~3.0	7.0~10.0
M3PM	2.0~3.3	3.8~5.1	M3D	2.0~3.0	5.5~8.0			
M3PL	2.0~3.3	5.9~7.2						
M3HS	2.0~3.3	5.1~6.4						

Flow chart

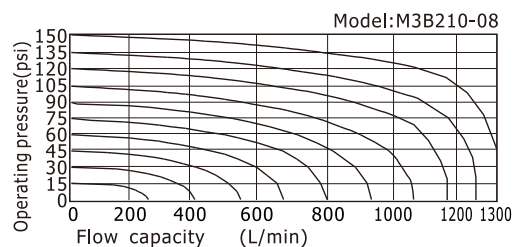
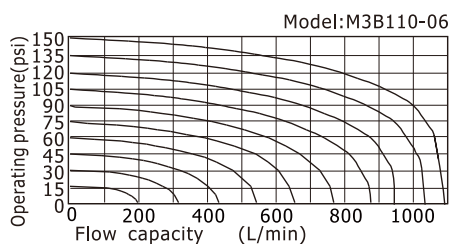
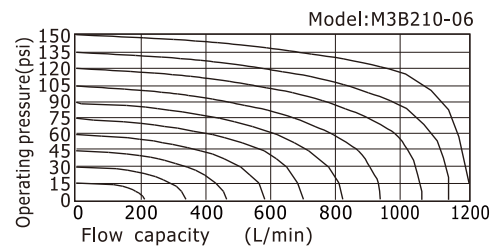
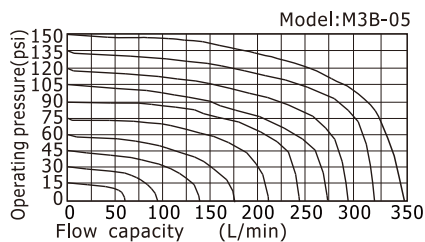

Control valve(3/2way)

M3 Series

Installation and Application

- 1) Body and panel installation (picture at right) :
- 2)The control set is made of engineering plastic which only allows manual operation and switching valves through metal impact is forbidden.
- 3)The series of M3B, M3C, M3D, M3PM, M3PF and M3PP get the function of automatic restoration. The hand valves of M3Y, M3HS and M3PL are in the type of manual restoration.M3PL will be restored by turning the revolve button after being pressed into orientation.
- 4) Pay attention to the reversing stroke. The reversing stroke can not surpass its stroke stipulated in stroke control table when the direction-change of the valve is forced by any external forces, otherwise it will cause the damage of the valve.
- 5) The M3L can only switch the valve in single direction (impact from right to left).
The impact from the other direction is invalid (from left to right).
- 6) Control joint combination can be ordered individually. Please refer to the table on the right for order details.

Fixation way of body

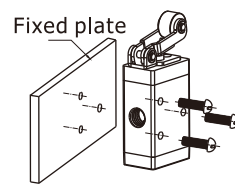

Fixation way of panel

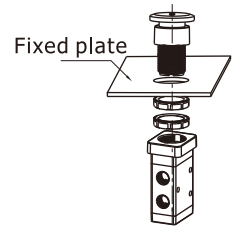

Dimensions

Common type

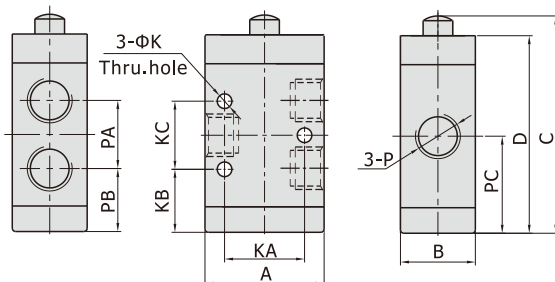

Model\Item	A	B	C	D	K	KA	KB	KC	P	PA	PB	PC
M3B11006	27	18	52	46.5	3.3	18	15.5	16	1/8"	16	15.5	23.5
M3B21006	35	22	64	58	4.3	23.5	18.5	20	1/8"	20	18.5	28.5
M3B21008									1/4"			

Mini type

[Unit: mm]

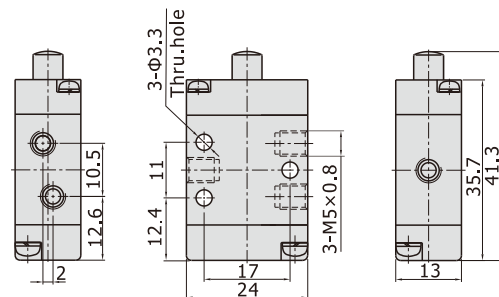

Short handle type(D)

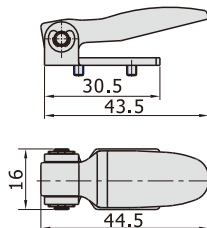

Model	Short handle type(D)
How to order	Ordering code
	Type
Applicable products	

Long handle type(C)

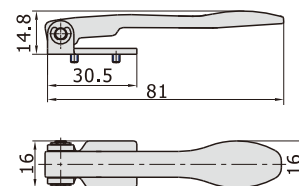

Model	Long handle type(C)
How to order	Ordering code
	Type
Applicable products	

Control valve(3/2way)

M3 Series

Roller type(R)

Mini type

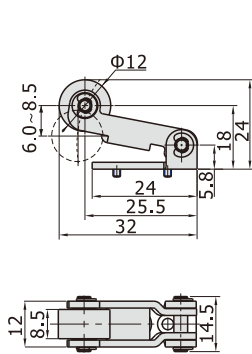

Common type

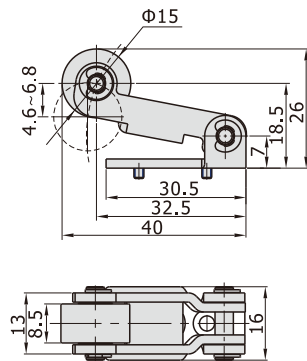

Model		Roller type(R)
How to order	Ordering code	M3R05-P14A
	Type	M3R05 Roller type control set
Applicable products		M3R05
How to order	Ordering code	M3R210-P14A
	Type	M3R210 Roller type control set
Applicable products		M3R110, M3R210

Roller with free return type(L)

Mini type

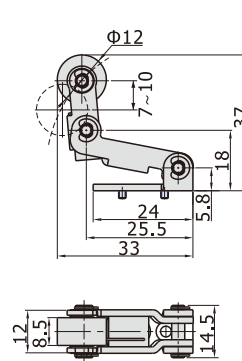

Common type

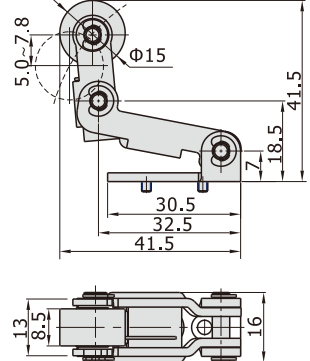

Model		Roller with free return type(L)
How to order	Ordering code	M3L05-P14A
	Type	M3L05 Roller with free return type control set
Applicable products		M3L05
How to order	Ordering code	M3L210-P14A
	Type	M3L210 Roller with free return type control set
Applicable products		M3L110, M3L210

Lever type(Y)

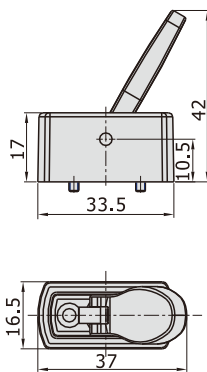

Model		Lever type(Y)
How to order	Ordering code	M3Y210-P13A
	Type	M3Y210 Lever type control set
Applicable products		M3Y110, M3Y210

Latching type(PL)

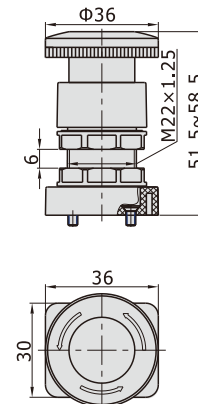

Model		Latching type (only red)(PL)
How to order	Ordering code	S3PL05-P12A
	Type	S3PL Latching type control set (Red)
Applicable products		M3PL110, M3PL210

Control valve(3/2way)

M3 Series

Mushroom type(PM)

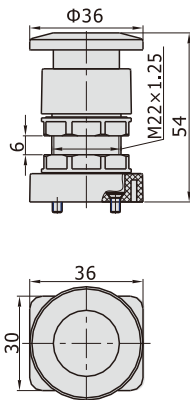

Model		Mushroom type(PM)
How to order	Ordering code	S3PM05-P11A
	Type	S3PM mushroom type control set (Green)
	Ordering code	S3PM05-P12A
	Type	S3PM mushroom type control set (Red)
	Ordering code	S3PM05-P13A
	Type	S3PM mushroom type control set (Black)
Applicable products		M3PM110, M3PM210

Protruding type(PP)

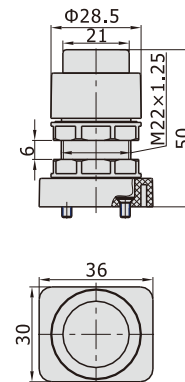

Model		Protruding type(PP)
How to order	Ordering code	S3PP05-P11A
	Type	S3PP protruding type control set (Green)
	Ordering code	S3PP05-P12A
	Type	S3PP protruding type control set (Red)
	Ordering code	S3PP05-P13A
	Type	S3PP protruding type control set (Black)
Applicable products		M3PP110, M3PP210

Flat type(PF)

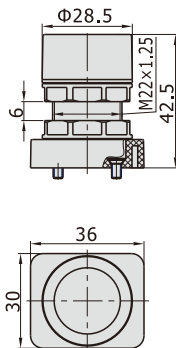

Model		Flat type(PF)
How to order	Ordering code	S3PF05-P11A
	Type	S3PF flat type control set (Green)
	Ordering code	S3PF05-P12A
	Type	S3PF flat type control set (Red)
	Ordering code	S3PF05-P13A
	Type	S3PF flat type control set (Black)
Applicable products		M3PF110, M3PF210

Selector type(HS)

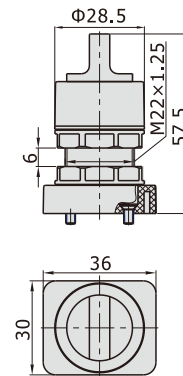

Model		Selector type(HS)
How to order	Ordering code	S3HS05-P11A
	Type	S3HS selector type control set (Green)
	Ordering code	S3HS05-P12A
	Type	S3HS selector type control set (Red)
	Ordering code	S3HS05-P13A
	Type	S3HS selector type control set (Black)
Applicable products		M3HS110, M3HS210