

Switch Mode Power Supply

S8VK-T (120/240/480/960 W Models)

Worldwide 3-phase Power Supply
Resistant in tough environments
Easy and fast installation
The most compact class on the market

- Wide input range for worldwide applications:
380 to 480 VAC (320 to 576 VAC)
- Possible for 2-phase input usage*:
380 to 480 VAC (340 to 576 VAC)
*When using the 960 W at 2-phase input, the power rating is 768 W.
- DC input can be available*:
450 to 600 VDC (450 to 810 VDC)
*Excluding 960 W
- High efficiency 91% typ. at 480 W model
- Wide operation temperature range: -40 to 70°C
- Power Boost function at 120%
- Meets LR maritime standards
- EMS: Conforms to EN 61204-3
EMI: EN61204-3 Class B
- RoHS Compliant
- Three years Warranty

Note: Three years warranty conditions: Rated input voltage, 80% load,
Ambient operating temperature: 40°C, Standard mounting



 Refer to *Safety Precautions for All Power Supplies and Safety Precautions* on page 13.

Related Products

DC Electronic Circuit Protector S8V-CP



Note: Refer to the S8V-CP Datasheet (Cat. No. T226-E1)
for details.

S8VK-T

Model Number Structure

Model Number Legend

S8VK-T□□□□□□
 1 2

1. Power Ratings

120: 120 W
240: 240 W
480: 480 W
960: 960 W

2. Output voltage

24: 24 V

Ordering Information

Note: For details on normal stock models, contact your nearest OMRON representative.

Power ratings	Input voltage	Output Voltage	Output current	Boost Current	Model number
120 W	2-phase and 3-phase 380 to 480 VAC 450 to 600 VDC	24 V	5 A	6 A	S8VK-T12024
240 W		24 V	10 A	12 A	S8VK-T24024
480 W		24 V	20 A	24 A	S8VK-T48024
960 W	3-phase 380 to 480 VAC	24 V	40 A	48 A	S8VK-T96024
	2-phase 380 to 480 VAC	24 V	32 A	-	

Specifications

Ratings, Characteristics, and Functions

Item	Power rating		120 W	240 W
	Output voltage		24 V	24 V
Efficiency	3-phase, 400 VAC input *11		89% typ.	89% typ.
Input	Voltage range *1		3-phase, 380 to 480 VAC (allowable range: 320 to 576 VAC) 2-phase, 380 to 480 VAC (allowable range: 340 to 576 VAC) 450 to 600 VDC (allowable range: 450 to 810 VDC) *8	
	Frequency *1		50/60 Hz (47 to 63 Hz)	
	Current	3-phase, 400 VAC input *11	0.38 A typ.	0.69 A typ.
	Power factor		-	
	Leakage current	3-phase, 400 VAC input	3.5 mA max./1.3 mA typ.	
	Inrush current (for a cold start at 25°C) *2	3-phase, 400 VAC input	28 A typ.	29 A typ.
Output	Rated output current		5 A	10 A
	Boost current		6 A	12 A
	Voltage adjustment range *3		22.5 to 29.5 VDC (with V.ADJ) (guaranteed)	
	Ripple & Noise voltage *4	3-phase, 400 VAC input *11	160 mV p-p max. at 20 MHz of bandwidth	190 mV p-p max. at 20 MHz of bandwidth
	Input variation influence *13		0.5% max.	
	Load variation influence *12		1.5% max.	
	Temperature variation influence	3-phase, 400 VAC input	0.05%/°C max.	
	Start up time *2	3-phase, 400 VAC input *11	700 ms typ.	600 ms typ.
Hold time *2	3-phase, 400 VAC input *11	30 ms typ.	20 ms typ.	
Additional functions	Overload protection		Yes, automatic reset	Yes, automatic reset
	Overvoltage protection		Yes, 130% or higher of rated output voltage, power shut off (shut off the input voltage and turn on the input again) *5	
	Series operation		Yes (For up to two Power Supplies, external diodes are required.)	
	Parallel operation		Yes (Refer to Engineering Data) (For up to two Power Supplies)	
	Output indicator		Yes (LED: Green), lighting from 80% to 90% or more of rated voltage	
Insulation	Withstand voltage		3.0 kVAC for 1 min. (between all input terminals and output terminals) cutoff current 20 mA 2.5 kVAC for 1 min. (between all input terminals and PE terminal) cutoff current 20 mA 1.0 kVAC for 1 min. (between all output terminals and PE terminal) cutoff current 30 mA	
	Insulation resistance		100 MΩ min. (between all output terminals and all input terminals / PE terminal) at 500 VDC	
Environment	Ambient operating temperature		-40 to 70°C (However, only startup is guaranteed for between -40°C to -25°C. (3-phase only)) (Derating is required according to the temperature.) (with no condensation or icing)	
	Storage temperature		-40 to 85°C (with no condensation or icing)	
	Ambient operating humidity		0% to 95% (Storage humidity: 0% to 95%)	
	Vibration resistance		10 to 55 Hz, 0.375-mm half amplitude for 2 h each in X, Y, and Z directions	
	Shock resistance		150 m/s ² , 3 times each in ±X, ±Y, and ±Z directions	
Reliability	MTBF		135,000 hrs min.	
	Life expectancy *10		10 years min.	
Construction	Weight		700 g max.	1,000 g max.
	Cooling fan		No	
	Degree of protection		IP20 by EN / IEC 60529	
Standards	Harmonic current emissions		Conforms to EN 61000-3-2	
	EMI	Conducted Emission	Conforms to EN 61204-3 Class B EN 55011 Class B	
		Radiated Emission	Conforms to EN 61204-3 Class B EN 55011 Class B	
	EMS		Conforms to EN 61204-3 high severity levels	
	Approved Standards *6		UL Listed: UL 508 *7 EN: EN 50178 Lloyd's standards *9 ANSI/ISA 12.12.01 *7	UL Listed: UL 508 *7 UL UR: UL 60950-1 (Recognition) cUR: CSA C22.2 No.60950-1 CSA: CSA C22.2 No.60950-1 EN: EN 50178, EN 60950-1 Lloyd's standards *9 ANSI/ISA 12.12.01 *7
	Conformed Standards		SELV (EN 50178), PELV(EN 60204-1, EN 50178) Safety of Power Transformers (EN 61558-2-16) EN 50274 for Terminal parts	SELV (EN 60950-1/EN 50178/UL 60950-1) PELV (EN 60204-1, EN 50178) Safety of Power Transformers (EN 61558-2-16) EN 50274 for Terminal parts
SEMI		Conforms to F47-0706 (3-phase, 380 to 480 VAC input)		

Note: Refer to page 5 for notes 1 to 13.

S8VK-T

Item	Power rating		480 W	960 W (768 W *18)
	Output voltage		24 V	24 V
Efficiency	3-phase, 400 VAC input *11		91% typ.	92% typ.
Input	Voltage range *1		3-phase, 380 to 480 VAC (allowable range: 320 to 576 VAC) 2-phase, 380 to 480 VAC (allowable range: 340 to 576 VAC) 450 to 600 VDC (allowable range: 450 to 810 VDC) *8	3-phase, 380 to 480 VAC (allowable range: 320 to 576 VAC) 2-phase, 380 to 480 VAC (allowable range: 340 to 576 VAC)
	Frequency *1		50/60 Hz (47 to 63 Hz)	
	Current	3-phase, 400 VAC input *11	1.2 A typ.	2.1 A typ.
	Power factor		-	
	Leakage current	3-phase, 400 VAC input	3.5 mA max./1.0 mA typ.	3.5 mA max./1.2 mA typ.
Inrush current (for a cold start at 25°C) *2	3-phase, 400 VAC input	28 A typ.		
Output	Rated output current		20 A	40 A at 3-phase (32 A at 2-phase)
	Boost current		24 A	48 A at 3-phase (Not possible at 2-phase)
	Voltage adjustment range *3		22.5 to 29.5 VDC (with V.ADJ) (guaranteed)	22.5 to 29.5 VDC (with V.ADJ) (guaranteed) *14
	Ripple & Noise voltage *4	3-phase, 400 VAC input *11	130 mV p-p max. at 20 MHz of bandwidth	90 mV p-p max. at 20 MHz of bandwidth
	Input variation influence *13		0.5% max.	
	Load variation influence *12		1.5% max.	
	Temperature variation influence	3-phase, 400 VAC input	0.05%/°C max.	
	Start up time *2	3-phase, 400 VAC input *11	500 ms typ.	700 ms typ.
Hold time *2	3-phase, 400 VAC input *11	20 ms typ.	20 ms typ.	
Additional functions	Overload protection		Yes, automatic reset	
	Overvoltage protection		Yes, 130% or higher of rated output voltage, power shut off (shut off the input voltage and turn on the input again) *5	
	Series operation		Yes (For up to two Power Supplies, external diodes are required.)	
	Parallel operation		Yes (Refer to Engineering Data) (For up to two Power Supplies)	
	Output indicator		Yes (LED: Green), lighting from 80% to 90% or more of rated voltage	
Insulation	Withstand voltage		3.0 kVAC for 1 min. (between all input terminals and output terminals) cutoff current 20 mA 2.5 kVAC for 1 min. (between all input terminals and PE terminal) cutoff current 20 mA 1.0 kVAC for 1 min. (between all output terminals and PE terminal) cutoff current 30 mA	
	Insulation resistance		100 MΩ min. (between all output terminals and all input terminals / PE terminal) at 500 VDC	
Environment	Ambient operating temperature		-40 to 70°C (However, only startup is guaranteed for between -40°C to -25°C. (3-phase only)) (Derating is required according to the temperature.) (with no condensation or icing)	
	Storage temperature		-40 to 85°C (with no condensation or icing)	
	Ambient operating humidity		0% to 95% (Storage humidity: 0% to 95%)	
	Vibration resistance		10 to 55 Hz, 0.375-mm half amplitude for 2 h each in X, Y, and Z directions	
	Shock resistance		150 m/s ² , 3 times each in ±X, ±Y, and ±Z directions	
Reliability	MTBF		135,000 hrs min.	
	Life expectancy *10		10 years min.	
Construction	Weight		1,600 g max.	2,700 g max.
	Cooling fan		No	
	Degree of protection		IP20 by EN / IEC 60529	
Standards	Harmonic current emissions		Conforms to EN 61000-3-2 *15	
	EMI	Conducted Emission	Conforms to EN 61204-3 Class B EN 55011 Class B *16	
		Radiated Emission	Conforms to EN 61204-3 Class B EN 55011 Class B *16	
	EMS		Conforms to EN 61204-3 high severity levels	
	Approved Standards *6		UL Listed: UL 508 *7 UL UR: UL 60950-1 (Recognition) cUR: CSA C22.2 No.60950-1 CSA: CSA C22.2 No.60950-1 EN: EN 50178, EN 60950-1 Lloyd's standards ANSI/ISA 12.12.01 *7	
	Conformed Standards		SELV (EN 60950-1/EN 50178/UL 60950-1) PELV (EN 60204-1, EN 50178) Safety of Power Transformers (EN 61558-2-16) EN 50274 for Terminal parts	
SEMI		Conforms to F47-0706 (3-phase, 380 to 480 VAC input) *17		

Note: Refer to page 5 for notes 1 to 18.

-
- *1. Do not use an inverter output for the Power Supply. Inverters with an output frequency of 50/60 Hz are available, but the rise in the internal temperature of the Power Supply may result in ignition or burning.
 - *2. For a cold start at 25°C. Refer to *Engineering Data* on page 8 to 9 for details.
 - *3. If the output voltage adjuster (V. ADJ) is turned, the voltage will increase by more than 29.5 VDC of the voltage adjustment range.
When adjusting the output voltage, confirm the actual output voltage from the Power Supply and be sure that the load is not damaged.
 - *4. A characteristic when the ambient operating temperature is between -25 to 70°C.
 - *5. Refer to *Overvoltage Protection* on page 9 for the time when input voltage shuts off and input turns on again.
 - *6. To meet safety standards, the S8VK-T must be protected with an external circuit-breaker or a fuse.
Be sure to use an external circuit-breaker or a fuse. Refer to *Precautions for Safe Use* on page 14 for details.
 - *7. The following supplementary Fuse/Circuit Breaker must be installed in accordance with NEC.:
Model FAZ-D5/3-NA, FAZ-D5/3-RT or FAZ-D5/3-DU, EATON INDUSTRIES (AUSTRIA) GMBH (E235139), Model KLKD5, LITTELFUSE INC. (E10480)
 - *8. Safety Standards for a DC Input
The following standards apply to a 450 to 600 VDC input: UL 60950-1, EN 50178, EN 60950-1, and Lloyd's standards.
 - *9. In the case of using side-mounting bracket (S82Y-VK10S, S82YVK20S), Lloyd's Standards are not applicable.
 - *10. The value is when rated output current is 50% or less, the ambient operating temperature is 40°C or less, standard mounting, and rated input voltage.
 - *11. The value is when both rated output voltage and rated output current are satisfied.
 - *12. 380 to 480 VAC input, in the range of 0 A to the rated output current.
 - *13. This is the maximum variation in the output voltage when the input voltage is gradually changed within the allowable input voltage range at the rated output voltage and rated output current.
 - *14. Use at 26.4 VDC or lower for 2-phase input.
 - *15. The S8VK-T Power Supply conforms to EN 61000-3-2 under the following conditions for 2-phase input.
480 W: rated output voltage, and 65% or less of rated output current
960 W: rated output voltage, and 45% or less of rated output current
 - *16. The S8VK-T Power Supply conforms to EMI under the following conditions for 2-phase input.
480 W: Conforms to class B: rated output voltage, and 65% or less of rated output current/
Conforms to class A: rated output voltage, and 65% to 100% of rated output current
960 W: Conforms to class B: rated output voltage, and 45% or less of rated output current/
Conforms to class A: rated output voltage, and 45% to 100% of rated output current
 - *17. 480 W: rated output voltage, and 50% or less of rated output current.
960 W: rated output voltage, and 92.5% or less of rated output current.
 - *18. When using 2-phase input. Refer to *2-Phase Input Operation For 960 W Model in Precautions for Safe Use* on page 17 for details.

S8VK-T

Connections

Block Diagrams

S8VK-T12024 (120 W)

S8VK-T24024 (240 W)

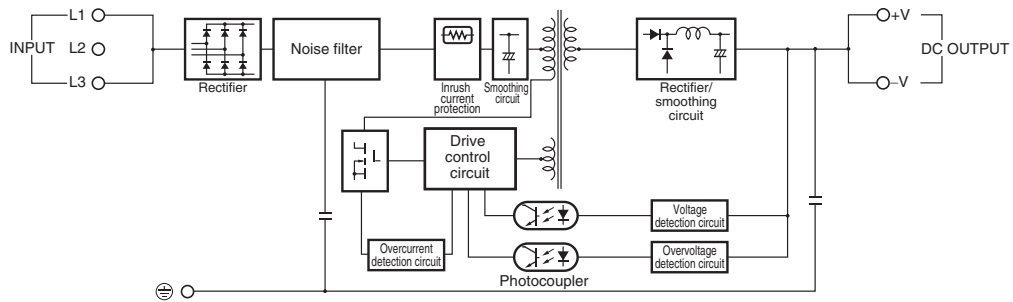

S8VK-T48024 (480 W)

S8VK-T96024 (960 W)

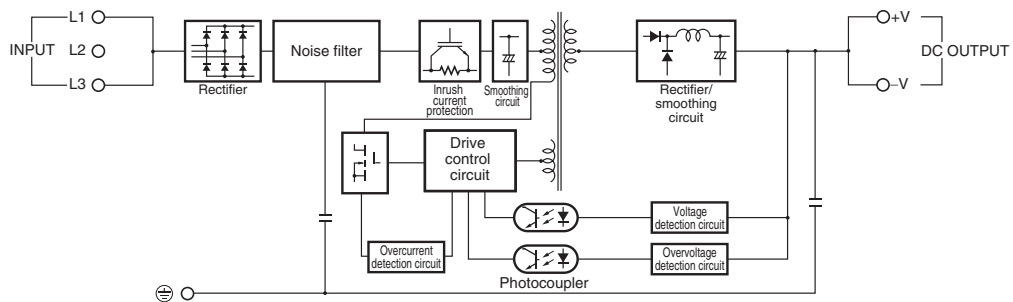

Construction and Nomenclature

Nomenclature

120 W Model

S8VK-T12024

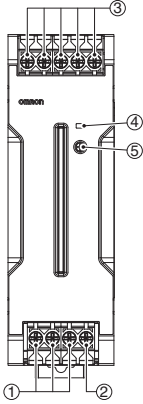

240 W Model

S8VK-T24024

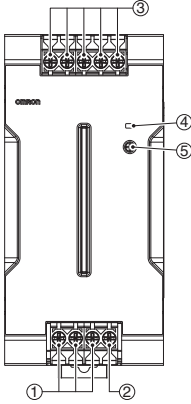

480 W Model

S8VK-T48024

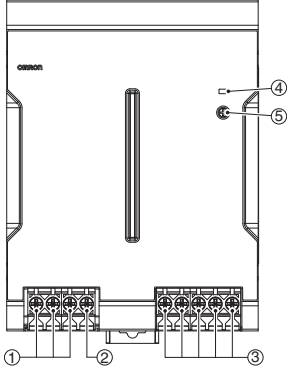

960 W Model

S8VK-T96024

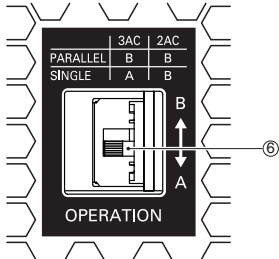
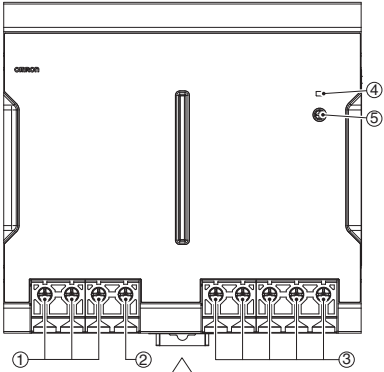

Note:
 A: The output current can use 100% of the rated output current.
 B: Overcurrent protection limits the output current to 80% of the rated output current.

No.	Name	Function
1	Input terminals (L1), (L2), (L3)	Connect the input lines to these terminals. *1
2	Protective Earth terminal (PE) / Ground	Connect the ground line to this terminal. *2
3	DC Output terminals (-V), (+V)	Connect the load lines to these terminals.
4	Output indicator (DC ON: Green)	Lights while a direct current (DC) output is ON.
5	Output voltage adjuster (V.ADJ)	Use to adjust the voltage.
6	Operation Switch *3 *4	To operate in parallel or 2-phase input, set the switch to the "B" side. (960 W model only).

*1. For wiring, refer to *Wiring in Precautions for Safe Use* on page 14.
 *2. This is the protective earth terminal specified in the safety standards. Always ground this terminal.
 *3. For parallel operation, refer to *Parallel Operation in Precautions for Safe Use* on page 16.
 *4. For 2-phase input, refer to *2-Phase Input Operation For 960 W Model in Precautions for Safe Use* on page 17.

S8VK-T

Engineering Data

Derating Curve

120 W (S8VK-T12024)

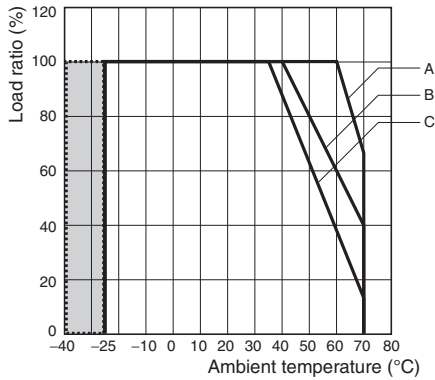

Note: This is the guaranteed value for startup. (3-phase only)

- A. Standard mounting
- B. Face-up mounting at 480 VAC or lower or 678 VDC or lower
- C. Face-up mounting at 576 VAC or lower or 810 VDC or lower

240 W (S8VK-T24024)

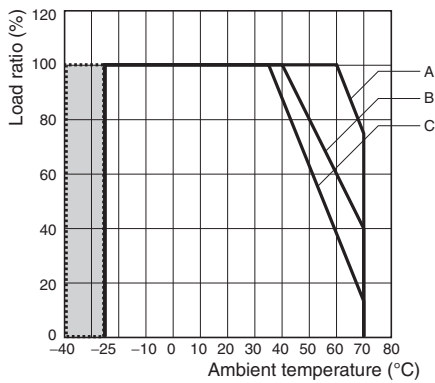

Note: This is the guaranteed value for startup. (3-phase only)

- A. Standard mounting
- B. Face-up mounting at 480 VAC or lower or 678 VDC or lower
- C. Face-up mounting at 576 VAC or lower or 810 VDC or lower

480 W (S8VK-T48024)

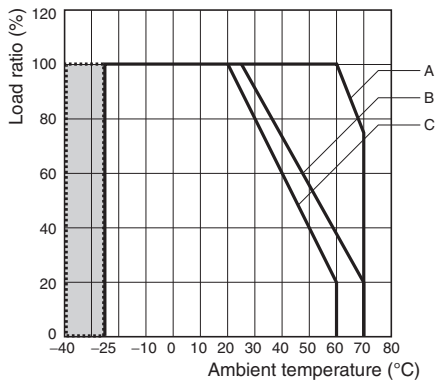

Note: This is the guaranteed value for startup. (3-phase only)

- A. Standard mounting
Over 528 VAC: the derating is 0.21%/VAC
Over 746 VAC: the derating is 0.16%/VDC
- B. Face-up mounting at 480 VAC or lower or 678 VDC or lower
- C. Face-up mounting at 576 VAC or lower or 810 VDC or lower

960 W (S8VK-T96024): Standard mounting

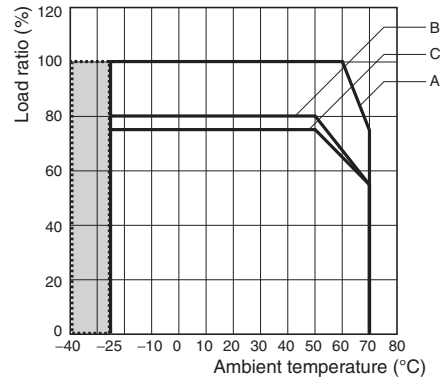

Note: This is the guaranteed value for startup. (3-phase only)

- A. 3-Phase (340 VAC or over to 576 VAC or lower)
For less than 340 VAC, it is possible to use with output voltage at 28.5 VDC or lower and load rate 60% or lower.
- B. 2-Phase (380 VAC or over to 576 VAC or lower, and output voltage 26.4 VDC or lower)
- C. 2-Phase (360 VAC or over to 380 VAC or lower, and output voltage 26.4 VDC or lower)
For 340 VAC or over to less than 360 VAC, it is possible to use with output voltage at 26.4 VDC or lower, and whichever is the smaller of the load rate 60% or lower or the value of C.

960 W (S8VK-T96024): Face-up mounting

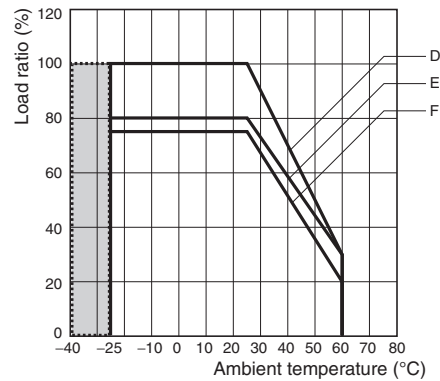

Note: This is the guaranteed value for startup. (3-phase only)

- D. 3-Phase (340 VAC or over to 576 VAC or lower)
For less than 340 VAC, it is possible to use with output voltage at 28.5 VDC or lower and load rate 60% or lower.
- E. 2-Phase (380 VAC or over to 480 VAC or lower, and output voltage 26.4 VDC or lower)
- F. 2-Phase (Over 480 VAC to 576 VAC or lower)
For 340 VAC or over to less than 380 VAC, it is possible to use with output voltage at 26.4 VDC or lower, and whichever is the smaller of the load rate 60% or lower or the value of F.

Mounting

(A) Standard (Vertical) mounting

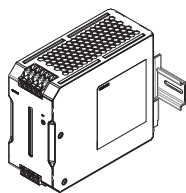

(B) Face-up mounting

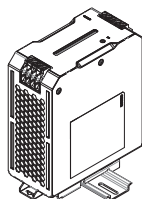

Overload Protection

The load and the power supply are automatically protected from overcurrent damage by this function.

Overload protection is activated if the output current rises above 121% of the rated current.

When the output current returns within the rated range, overload protection is automatically cleared.

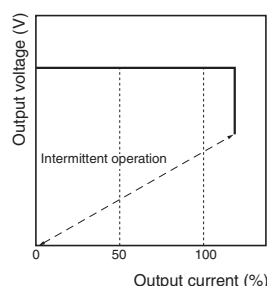

The values shown in the above diagrams are for reference only.

- Note:**
- Internal parts may occasionally deteriorate or be damaged if a short-circuited or overcurrent state continues during operation.
 - Internal parts may possibly deteriorate or be damaged if the Power Supply is used for applications with frequent inrush current or overloading at the load end. Do not use the Power Supply for such applications.

Overvoltage Protection

Consider the possibility of an overvoltage and design the system so that the load will not be subjected to an excessive voltage even if the feedback circuit in the Power Supply fails. If an excessive voltage that is approximately 130% of the rated voltage or more is output, the output voltage is shut OFF. Reset the input power by turning it OFF for at least five minutes and then turning it back ON again.

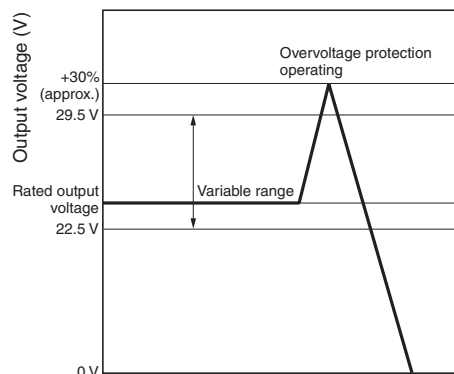

The values shown in the above diagram is for reference only.

Note: Do not turn ON the power again until the cause of the overvoltage has been removed.

Inrush Current, Startup Time, Output Hold Time

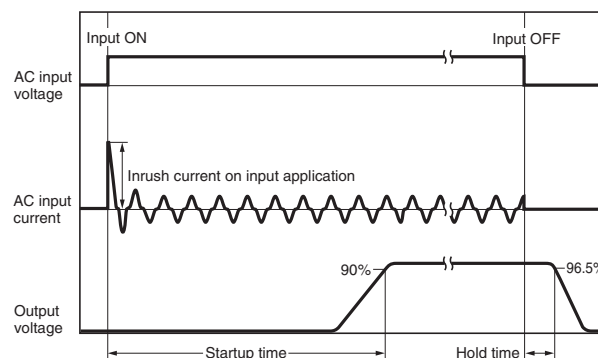

Note: Twice the input current or above will flow during the parallel operation or redundant system. Therefore, check the fusing characteristics of fuses and operating characteristics of breakers making sure that the external fuses will not burn out and the circuit breakers will not be activated by the inrush current.

Reference Value

	Value
Reliability (MTBF)	120 W: 390,000 h 240 W: 350,000 h 480 W: 280,000 h 960 W: 260,000 h
Definition	MTBF stands for Mean Time Between Failures, which is calculated according to the probability of accidental device failures, and indicates reliability of devices. Therefore, it does not necessarily represent a life of the product.
Life expectancy	10 years. Min.
Definition	The life expectancy indicates average operating hours under the ambient temperature of 40°C and a load rate of 50%. Normally this is determined by the life expectancy of the built-in aluminum electrolytic capacitor.

S8VK-T

Dimensions

(Unit: mm)

S8VK-T12024 (120 W)

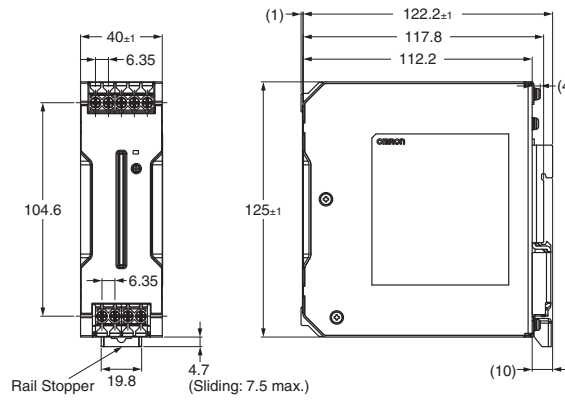

S8VK-T24024 (240 W)

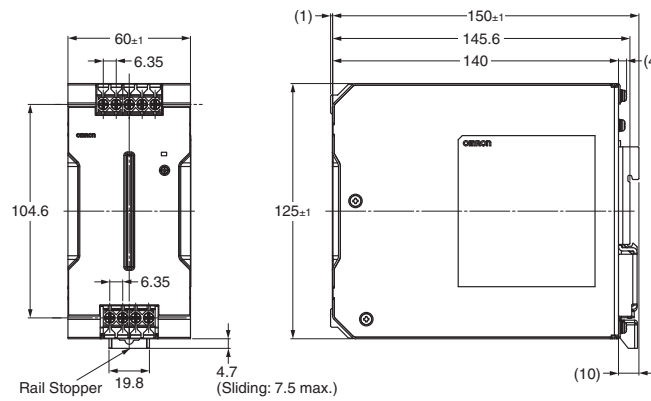

S8VK-T48024 (480 W)

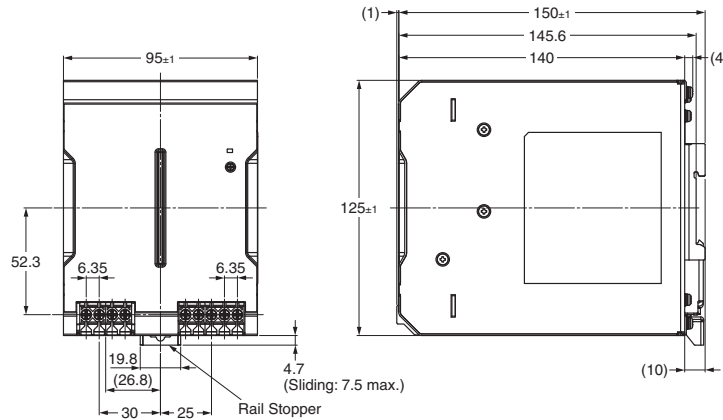

S8VK-T96024 (960 W)

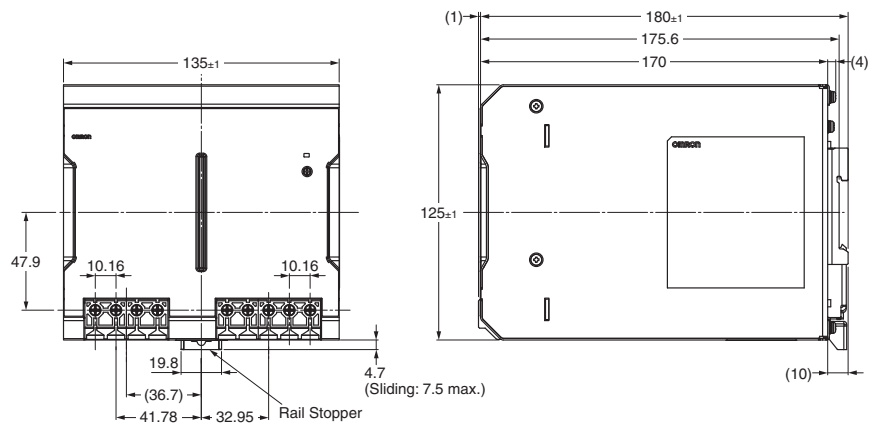

DIN Rail (Order Separately)

Note: All units are in millimeters unless otherwise indicated.

Mounting Rail (Material: Aluminum)

PFP-100N
PFP-50N

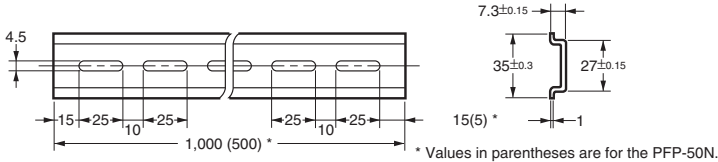
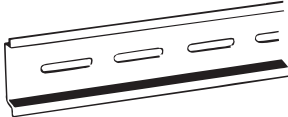

Mounting Rail (Material: Aluminum)

PFP-100N2

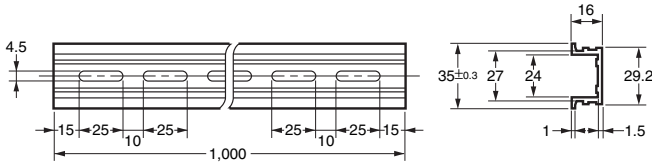
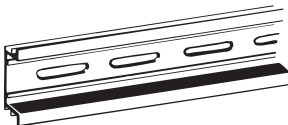

End Plate

PFP-M

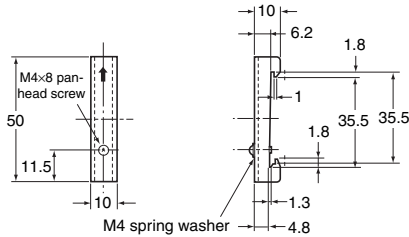

Note: If there is a possibility that the Unit will be subject to vibration or shock, use a steel DIN Rail. Otherwise, metallic filings may result from aluminum abrasion.

Mounting Brackets

Name	Model	Qty used
Front-mounting bracket (for 120, 240 and 480 W models)	S82Y-VK10F	1
Front-mounting bracket (for 960 W model)	S82Y-VK10F	2
Side-mounting bracket (for 120 W model)	S82Y-VK10S	1
Side-mounting bracket (for 240 W model)	S82Y-VK20S	1

Note: Be sure to use the accessory screws.

Mounting screw tightening torque (recommended): 4.43 to 5.31 lb-in (0.5 to 0.6 N·m)

Type	Model	Dimensions	Appearance
Front-mounting bracket (for 120, 240, 480 W and 960 W models)	S82Y-VK10F		<p>120 W model 240 W model</p> <p>960 W model</p>
			<p>Left-side mounting Right-side mounting</p> <p>Left-side mounting (DIN Rail) * Right-side mounting (DIN Rail) *</p>
Side-mounting bracket (For 240 W model)	S82Y-VK20S		<p>Left-side mounting Right-side mounting</p> <p>Left-side mounting (DIN Rail) * Right-side mounting (DIN Rail) *</p>





* You can mount the side of the Power Supply to a DIN Rail by removing the DIN Rail Back-mounting Bracket and then attaching a Side-mounting Bracket to the Power Supply.

Safety Precautions

Warning Indications

 CAUTION	Indicates a potentially hazardous situation which, if not avoided, may result in minor or moderate injury or in property damage.
Precautions for Safe Use	Supplementary comments on what to do or avoid doing, to use the product safely.
Precautions for Correct Use	Supplementary comments on what to do or avoid doing, to prevent failure to operate, malfunction or undesirable effect on product performance.

Meaning of Product Safety Symbols

	Used to warn of the risk of electric shock under specific conditions.
	Used to warn of the risk of minor injury caused by high temperatures.
	Used for general mandatory action precautions for which there is no specified symbol.
	Used to indicate prohibition when there is a risk of minor injury from electrical shock or other source if the product is disassembled.

CAUTION

Minor electric shock, fire, or Product failure may occasionally occur. Do not disassemble, modify, or repair the Product or touch the interior of the Product.



Minor burns may occasionally occur. Do not touch the Product while power is being supplied or immediately after power is turned OFF.



Fire may occasionally occur. Tighten terminal screws to the specified torque.

S8VK-T12024, S8VK-T24024, S8VK-T48024:

4.43 to 5.31 lb-in (0.5 to 0.6 N·m)

S8VK-T96024:

10.62 to 13.28 lb-in (1.2 to 1.5 N·m)



Minor injury due to electric shock may occasionally occur. Do not touch the terminals while power is being supplied.



Minor electric shock, fire, or Product failure may occasionally occur. Do not allow any pieces of metal or conductors or any clippings or cuttings resulting from installation work to enter the Product.



If the external breaker or fuse is tripped, the equipment may have been seriously damaged. Do not turn ON the input again.



Precautions for Safe Use

Wiring

- Connect the ground completely. A protective earthing terminal stipulated in safety standards is used. Electric shock or malfunction may occur if the ground is not connected completely.
- Minor fire may possibly occur. Ensure that input and output terminals are wired correctly.
- Do not apply more than 75-N force to the terminal block when tightening it.
- Be sure to remove the sheet covering the Product for machining before power-ON so that it does not interfere with heat dissipation.
- To comply with safety standards and to ensure equipment safety, connect the input to the S8VK-T through one of the following Breakers or Fuses.

- Use the following material for the wires to be connected to the S8VK-T to prevent smoking or ignition caused by abnormal loads or phase failure.
- Wire the input as shown in the following figures depends on your power distribution system. Do not connect the neutral line in a 3-phase, 4-wire system.

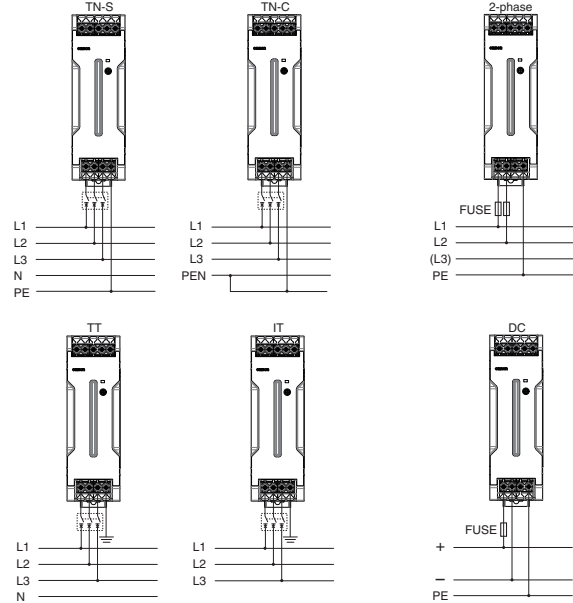

Power circuit-breakers

Model	Input	Power circuit-breakers
S8VK-T12024 S8VK-T24024	3-phase	Circuit breaker Conforming UL/CE 480 V, 5 A, characteristic D, 3-pole, or equivalent breaker
	2-phase/DC	Fuse Conforming UL/CE 600 V, 5 A Fast Acting or identical function fuse
S8VK-T48024 S8VK-T96024	3-phase	Circuit breaker Conforming UL/CE 480 V, 5 A, characteristic D, 3-pole, or equivalent breaker
	2-phase/DC	Fuse Conforming UL/CE 600 V, 10 A Fast Acting or identical function fuse

Note: Do not use the S8VK-T96024 with a DC input.

Recommended Wire Type/Cross-sectional Area and Stripping Length

Model	INPUT		OUTPUT		PE / Ground		Wire stripping Length
	American Wire Gauge	Solid Wire /Stranded Wire	American Wire Gauge	Solid Wire /Stranded Wire	American Wire Gauge	Solid Wire /Stranded Wire	
S8VK-T12024	AWG22 to 10	0.35 to 6 mm ² /0.35 to 4 mm ²	AWG18 to 10	0.75 to 6 mm ² /0.75 to 4 mm ²	AWG14 to 10	2.5 to 6 mm ² /2.5 to 4 mm ²	8 to 10 mm
S8VK-T24024	AWG22 to 10	0.35 to 6 mm ² /0.35 to 4 mm ²	AWG14 to 10	2.5 to 6 mm ² /2.5 to 4 mm ²			
S8VK-T48024	AWG20 to 10	0.5 to 6 mm ² /0.5 to 4 mm ²	AWG12 to 10	4 to 6 mm ² /4 mm ²			
S8VK-T96024	AWG16 to 6	1.5 to 16 mm ² /1.5 to 16 mm ²	AWG8 to 6	10 to 16 mm ² /10 to 16 mm ²	AWG14 to 6	2.5 to 16 mm ² /2.5 to 16 mm ²	13 to 16 mm

- The wire insertion hole, and applicable screwdriver of the terminal block are as follows.

Model	Wire Insertion Hole (Refer to the diagram on the right)		Applicable Screwdriver		
	W	L	No.	Driver Diameter	Length
S8VK-T12024	2.9	2.9	#2	4.9 mm max.	10 mm min.
S8VK-T24024					
S8VK-T48024					
S8VK-T96024	5.4	5	#2	5.1 mm max.	12 mm min.



Installation Environment

- Do not use the Power Supply in locations subject to shocks or vibrations. In particular, install the Power Supply as far away as possible from contactors or other devices that are a vibration source. For usage onboard a ship, always attach an End Plate (PFP-M) to both sides of the Power Supply to hold the Power Supply in place.
- Install the Power Supply well away from any sources of strong, high-frequency noise and surge.

Operating Life

- The life of a Power Supply is determined by the life of the electrolytic capacitors used inside. Here, Arrhenius Law applies, i.e., the life will be cut in half for each rise of 10°C or the life will be doubled for each drop of 10°C. The life of the Power Supply can

thus be increased by reducing its internal temperature.

Ambient Operating and Storage Environments

- Store the Power Supply at a temperature of -40 to 85°C and a humidity of 0% to 95%.
- Do not use the Power Supply in areas outside the derating curve otherwise, internal parts may occasionally deteriorate or be damaged.
- Use the Power Supply at a humidity of 0% to 95%.
- Do not use the Power Supply in locations subject to direct sunlight.
- Do not use the Power Supply in locations where liquids, foreign matter, or corrosive gases may enter the interior of Products.

Mounting

- Take adequate measures to ensure proper heat dissipation to increase the long-term reliability of the Product. Be sure to allow convection in the atmosphere around devices when mounting. Do not use in locations where the ambient temperature exceeds the range of the derating curve.
- When cutting out holes for mounting, make sure that cuttings do not enter the interior of the Products.

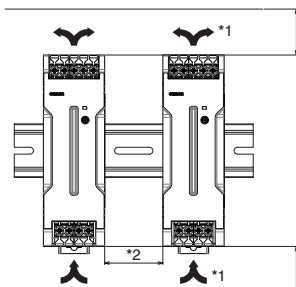

*1. Convection of air
*2. 20 mm min.

- Improper mounting will interfere with heat dissipation and may occasionally result in deterioration or damage of internal parts. Use the Product within the derating curve for the mounting direction that is used.

Overload Protection

- Internal parts may possibly deteriorate or be damaged if a short-circuited or overcurrent state continues during operation.
- Internal parts may possibly deteriorate or be damaged if the Power Supply is used for applications with frequent inrush current or overloading at the load end. Do not use the Power Supply for such applications.
- The DC ON indicator (green) flashes if the overload protection function operates.

Charging a Battery

If you connect a battery as the load, install overcurrent control and overvoltage protection circuits.

Output Voltage Adjuster (V.ADJ)

- The output voltage adjuster (V.ADJ) may possibly be damaged if it is turned with unnecessary force. Do not turn the adjuster with excessive force.
- After completing output voltage adjustment, be sure that the output capacity or output current does not exceed the rated output capacity or rated output current.

DIN Rail Mounting

To mount the Block on a DIN Rail, hook portion (A) of the Block onto the rail and press the Block in direction (B).

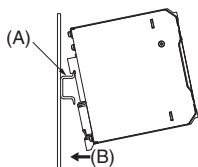

To dismount the Block, pull down portion (C) with a flat-blade screwdriver and pull out the Block.

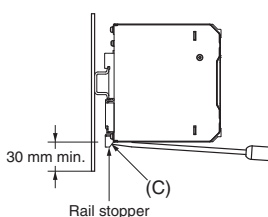

Power Boost Function

For All Models

Power Boost is a function that can output the temporary repeated boost current larger than the rated current. However, it should meet the following four Boost current conditions.

1. Time that the boost current flows: t1
2. The maximum value of the boost current: I_p
3. The average output current: I_{ave}
4. The time ratio of the boost current flow: Duty

Note: Boost current conditions

- t1 ≤ 10 s
- I_p ≤ Rated boost current
- I_{ave} ≤ Rated current

$$\text{Duty} = \frac{t_1}{t_1 + t_2} \times 100 [\%] \leq 30\%$$

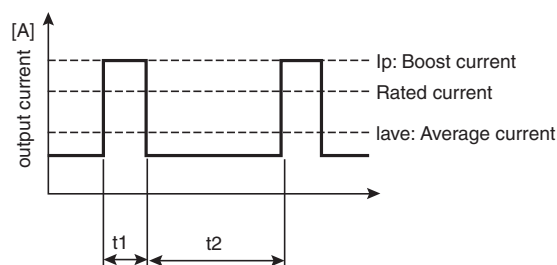

- Do not allow the boost current to continue for more than 10 seconds. Also, do not let the duty cycle exceed the boost current conditions. These conditions may damage the Power supply.
- Ensure that the average current of one cycle of the boost current does not exceed the rated output current. This may damage the Power Supply.
- Lessen the load of the boost load current by adjusting the ambient temperature and the mounting direction.
- Power Boost Function is not possible for the S8VK-T 960 W at 2-phase input or in parallel operation.

Series Operation

Two power supplies can be connected in series.

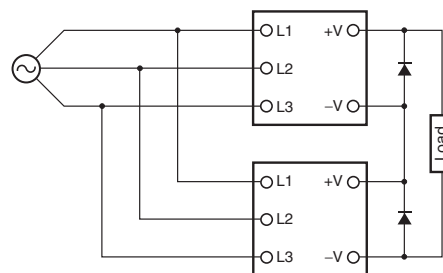

- Note: 1.** The diode is connected as shown in the figure. If the load is short-circuited, a reverse voltage will be generated inside the Power Supply. If this occurs the Power Supply may possibly deteriorate or be damaged. Always connect a diode as shown in the figure. Select a diode having the following ratings.

Type	Schottky Barrier diode
Dielectric strength (VRRM)	Twice the rated output voltage or above
Forward current (I _F)	Twice the rated output current or above

- 2.** Although Products having different specifications can be connected in series, the current flowing through the load must not exceed the smaller rated output current.

Making Positive/Negative Outputs

- The outputs are floating outputs (i.e., the primary circuits and secondary circuits are separated). You can therefore make positive and negative outputs by using two Power Supplies. You can make positive and negative outputs with any of the models.

If positive and negative outputs are used, connect Power Supplies of the same model as in the following figure. (Combinations with different output capacities or output voltages can be made. However, use the lower of the two maximum rated output currents as the current to the loads.)

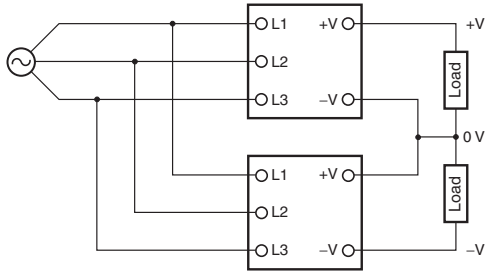

- Depending on the model, internal circuits may be damaged due to startup failure when the power is turned ON if loads such as a servomotor or operational amplifier may operate in series. Therefore, connect bypass diodes (D₁, D₂) as shown in the following figure.

If the list of models that support series connection of outputs says that an external diode is not required, an external diode is also not required for positive/negative outputs.

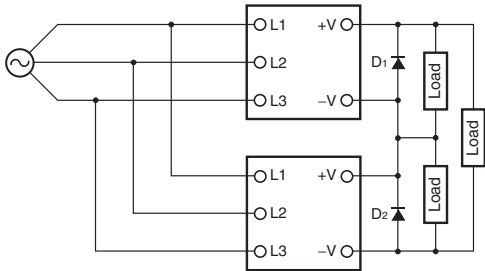

- Use the following information as a guide to the diode type, dielectric strength, and current.

Type	Schottky Barrier diode
Dielectric strength (VRRM)	Twice the rated output voltage or above
Forward current (IF)	Twice the rated output current or above

Parallel Operation

Parallel operation is used when the output current from one Power Supply is insufficient for the load. Power Supplies are connected in parallel to increase the output current.

Two Power Supplies can be connected in parallel.

- Parallel operation is possible only if the standard mounting and 3-phase input is used. Maintain an ambient temperature of between -25 and 40°C.
- For parallel operation, always use two Power Supplies with the same capacity.
- Use the output voltage adjusters (V. ADJ) to adjust the difference in the output voltages between the two Power Supplies to 50 mV or less.
- If the output current from the two Power Supplies is not balanced, the Power Supply with the higher output voltage will operate in an overcurrent protection state, which will extremely reduce its service life. After you adjust the difference in the output voltages between the two Power Supplies, make sure that the currents are well balanced.
- The length and thickness of each wire connected to the load and each unit must be the same so that there is no difference in the voltage drop value between the load and the output terminals of each Power Supply.
- For Parallel Operation with units 120 W, 240 W S8VK-T Power Supplies, connect diodes or S8VK-R to the outputs of each unit if sudden load variation influence occurs in the ambient operation environment. Refer to the S8VK-R datasheet (Catalog No.: T059) for S8VK-R specifications and the model number for each capacity.

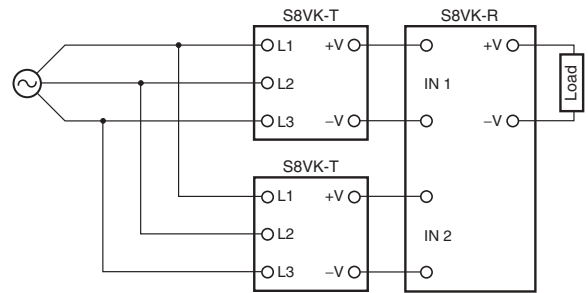

- The internal parts may occasionally be deteriorated or broken. Be sure to set the OPERATION SWITCH to B when using S8VK-T 480 W, 960 W for Parallel Operation. For Parallel Operation with units 960 W S8VK-T Power Supplies, connect diodes to the outputs of each unit if sudden load variation influence occurs in the ambient operation environment.

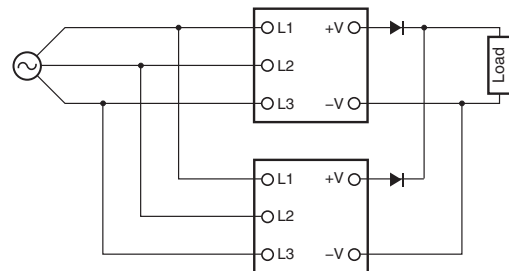

- Use the following information as a guide to the diode type, dielectric strength, and current.

Type	Schottky Barrier diode
Dielectric strength (VRRM)	Twice the rated output voltage or above
Forward current (IF)	Twice the rated output current or above

Backup Operation

Backup operation is possible if you use two Power Supplies of the same model. Even if one Power Supply fails, operation can be continued with the other Power Supply. Make sure that the maximum load does not exceed the capacity of one Power Supply. For backup operation, connect the S8VK-R for 120 W, 240 W, and 480 W. Refer to the S8VK-R datasheet (Catalog No.: T059) for S8VK-R specifications and the model number for each capacity.

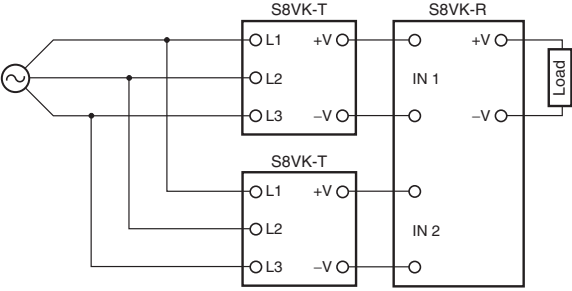

For 960 W, always connect diodes to the output sides of the two Power Supplies as shown in the following diagram.

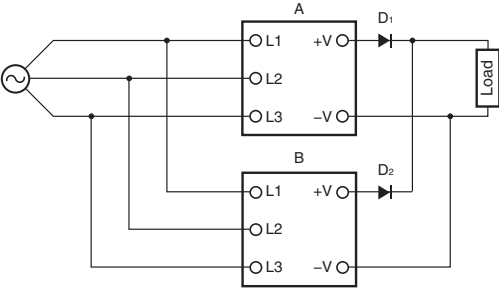

- Use the following information as a guide to the diode type, dielectric strength, and current.

Type	Schottky Barrier diode
Dielectric strength (VRRM)	Twice the rated output voltage or above
Forward current (IF)	Twice the rated output current or above

- Increase the output voltage setting of Power Supply A and Power Supply B by the drop in the forward voltage (VF) of diodes D1 and D2. Also, the diodes will cause a power loss equivalent to the Power Supply output current (IOUT) times the diode forward voltage (VF). Therefore, cooling measures must be implemented so that the temperature of the diodes decreases to the catalog value or lower.
- Because of the load power and power loss due to the diodes, do not exceed the rated power of one Power Supply (rated output voltage × rated output current).

In Case There Is No Output Voltage

The possible cause for no output voltage may be that the overcurrent or overvoltage protection has operated. The internal protection may operate if a large amount of surge voltage such as a lightning surge occurs while turning ON the power supply. In case there is no output voltage, please check the following points before contacting us:

- Checking overload protected status: Check whether the load is in overload status or is short-circuited. Remove wires to load when checking.
- Checking overvoltage or internal protection: Turn the power supply OFF once, and leave it OFF for at least 5 minutes. Then turn it ON again to see if this clears the condition.

2-Phase Input Operation For 960 W Model

The internal parts may occasionally be deteriorated or broken. Be sure to set the OPERATION SWITCH to B when using S8VK-T 960 W at 2-phase input.

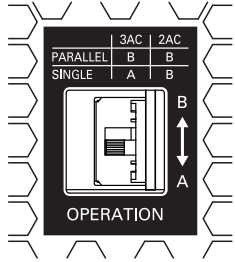

- Note:**
- A: The output current can use 100% of the rated output current.
 - B: Overcurrent protection limits the output current to 80% of the rated output current.

S8VK-T

Period and Terms of Warranty

Warranty Period

The product warranty is valid for a period of three years from the date of shipment from the factory.

Terms of Warranty

The warranty is valid only for the following operating conditions.

1. Average ambient operating temperature of the product: 40°C max.
2. Average load rate: 80% max.
3. Mounting method: Standard mounting

* The maximum ratings must be within the derating curve.

If the product fails for reasons attributable to OMRON within the above warranty period, OMRON will repair or replace the faulty part of the product at the place of purchase or the place where the product delivered without charge.

This warranty does not cover the following types of failures.

- (1) Failures that result from handling or operation of the product under conditions or in environments that are not given in this document and not given in any other specifications exchanged between OMRON and the customer
 - (2) Failures that originate in causes other than the delivered product itself
 - (3) Failures caused by disassembly, modification, or repair of the product by anyone other than OMRON
 - (4) Failures caused by applications or uses for which the product was not originally intended
 - (5) Failures caused by factors that could not be anticipated with the scientific or technical knowledge available when the product was shipped
 - (6) Failures caused by other causes for which OMRON is not responsible, such as natural disasters and other acts of God
- This warranty is limited to the individual product that was delivered and does not cover any secondary, subsequent, or related damages.

Recommended Replacement Periods and Periodic Replacement for Preventive Maintenance

The recommended replacement period for preventive maintenance is greatly influenced by the application environment of the product. As a guideline, the recommended replacement period is 7 to 10 years.*

To prevent failures or accidents that can be caused by using a product beyond its service life, we recommend that you replace the product as early as possible within the recommended replacement period.

However, bear in mind that the recommended replacement period is for reference only and does not guarantee the life of the product.

Many electronic components are used in the product and the product depends on the correct operation of these components to achieve the original product functions and performance.

However, the influence of the ambient temperature on aluminum electrolytic capacitors is large, and the service life is reduced by half for each 10°C rise in temperature (Arrhenius law).

When the capacity reduction life of the electrolytic capacitor is reached, the product failures or accidents may occur.

We therefore recommend that you replace the product periodically to minimize product failures or accidents in advance.

* The recommended replacement period applies under the following conditions: rated input voltage, load rate of 50% max., ambient temperature of 40°C max., and the standard mounting method. (The fan is excluded for models with fans.)

This product model is designed with a service life of 10 years minimum under the above conditions.

Terms and Conditions Agreement

Read and understand this catalog.

Please read and understand this catalog before purchasing the products. Please consult your OMRON representative if you have any questions or comments.

Warranties.

- (a) Exclusive Warranty. Omron's exclusive warranty is that the Products will be free from defects in materials and workmanship for a period of twelve months from the date of sale by Omron (or such other period expressed in writing by Omron). Omron disclaims all other warranties, express or implied.
- (b) Limitations. OMRON MAKES NO WARRANTY OR REPRESENTATION, EXPRESS OR IMPLIED, ABOUT NON-INFRINGEMENT, MERCHANTABILITY OR FITNESS FOR A PARTICULAR PURPOSE OF THE PRODUCTS. BUYER ACKNOWLEDGES THAT IT ALONE HAS DETERMINED THAT THE PRODUCTS WILL SUITABLY MEET THE REQUIREMENTS OF THEIR INTENDED USE.

Omron further disclaims all warranties and responsibility of any type for claims or expenses based on infringement by the Products or otherwise of any intellectual property right. (c) Buyer Remedy. Omron's sole obligation hereunder shall be, at Omron's election, to (i) replace (in the form originally shipped with Buyer responsible for labor charges for removal or replacement thereof) the non-complying Product, (ii) repair the non-complying Product, or (iii) repay or credit Buyer an amount equal to the purchase price of the non-complying Product; provided that in no event shall Omron be responsible for warranty, repair, indemnity or any other claims or expenses regarding the Products unless Omron's analysis confirms that the Products were properly handled, stored, installed and maintained and not subject to contamination, abuse, misuse or inappropriate modification. Return of any Products by Buyer must be approved in writing by Omron before shipment. Omron Companies shall not be liable for the suitability or unsuitability or the results from the use of Products in combination with any electrical or electronic components, circuits, system assemblies or any other materials or substances or environments. Any advice, recommendations or information given orally or in writing, are not to be construed as an amendment or addition to the above warranty.

See <http://www.omron.com/global/> or contact your Omron representative for published information.

Limitation on Liability; Etc.

OMRON COMPANIES SHALL NOT BE LIABLE FOR SPECIAL, INDIRECT, INCIDENTAL, OR CONSEQUENTIAL DAMAGES, LOSS OF PROFITS OR PRODUCTION OR COMMERCIAL LOSS IN ANY WAY CONNECTED WITH THE PRODUCTS, WHETHER SUCH CLAIM IS BASED IN CONTRACT, WARRANTY, NEGLIGENCE OR STRICT LIABILITY.

Further, in no event shall liability of Omron Companies exceed the individual price of the Product on which liability is asserted.

Suitability of Use.

Omron Companies shall not be responsible for conformity with any standards, codes or regulations which apply to the combination of the Product in the Buyer's application or use of the Product. At Buyer's request, Omron will provide applicable third party certification documents identifying ratings and limitations of use which apply to the Product. This information by itself is not sufficient for a complete determination of the suitability of the Product in combination with the end product, machine, system, or other application or use. Buyer shall be solely responsible for determining appropriateness of the particular Product with respect to Buyer's application, product or system. Buyer shall take application responsibility in all cases.

NEVER USE THE PRODUCT FOR AN APPLICATION INVOLVING SERIOUS RISK TO LIFE OR PROPERTY OR IN LARGE QUANTITIES WITHOUT ENSURING THAT THE SYSTEM AS A WHOLE HAS BEEN DESIGNED TO ADDRESS THE RISKS, AND THAT THE OMRON PRODUCT(S) IS PROPERLY RATED AND INSTALLED FOR THE INTENDED USE WITHIN THE OVERALL EQUIPMENT OR SYSTEM.

Programmable Products.

Omron Companies shall not be responsible for the user's programming of a programmable Product, or any consequence thereof.

Performance Data.

Data presented in Omron Company websites, catalogs and other materials is provided as a guide for the user in determining suitability and does not constitute a warranty. It may represent the result of Omron's test conditions, and the user must correlate it to actual application requirements. Actual performance is subject to the Omron's Warranty and Limitations of Liability.

Change in Specifications.

Product specifications and accessories may be changed at any time based on improvements and other reasons. It is our practice to change part numbers when published ratings or features are changed, or when significant construction changes are made. However, some specifications of the Product may be changed without any notice. When in doubt, special part numbers may be assigned to fix or establish key specifications for your application. Please consult with your Omron's representative at any time to confirm actual specifications of purchased Product.

Errors and Omissions.

Information presented by Omron Companies has been checked and is believed to be accurate; however, no responsibility is assumed for clerical, typographical or proofreading errors or omissions.

OMRON Corporation Industrial Automation Company
Kyoto, JAPAN

Contact: www.ia.omron.com

Regional Headquarters

OMRON EUROPE B.V.

Wegalaan 67-69, 2132 JD Hoofddorp
The Netherlands
Tel: (31)2356-81-300/Fax: (31)2356-81-388

OMRON ELECTRONICS LLC

2895 Greenspoint Parkway, Suite 200
Hoffman Estates, IL 60169 U.S.A.
Tel: (1) 847-843-7900/Fax: (1) 847-843-7787

OMRON ASIA PACIFIC PTE. LTD.

No. 438A Alexandra Road # 05-05/08 (Lobby 2),
Alexandra Technopark,
Singapore 119967
Tel: (65) 6835-3011/Fax: (65) 6835-2711

OMRON (CHINA) CO., LTD.

Room 2211, Bank of China Tower,
200 Yin Cheng Zhong Road,
PuDong New Area, Shanghai, 200120, China
Tel: (86) 21-5037-2222/Fax: (86) 21-5037-2200

Authorized Distributor:

© OMRON Corporation 2014-2019 All Rights Reserved.
In the interest of product improvement,
specifications are subject to change without notice.

CSM_8_3_0120

Cat. No. T061-E1-03

1019 (0414)