

# Vacuum / Release Unit

## VQD1000-V Series

Rubber Seal

- Response speed *Adaptable to 0603 chip*  [Option]  
**13 msec** (at 500 mm\*) / **18.5 msec** (at 1000 mm\*)  
\* Distance from the unit to the work area
- **Smooth detachment of a work piece without over-blow**  
 The work piece will not be blown away when the air is released.
- **No need to adjust the timing when switching between vacuum and positive pressure.** (single signal control)
- **No need to design a restrictor circuit for release air.**
- **N.O.** (Vacuum absorption type when de-energized) and **N.C.** (Vacuum shutoff type when de-energized) **specifications are available.**

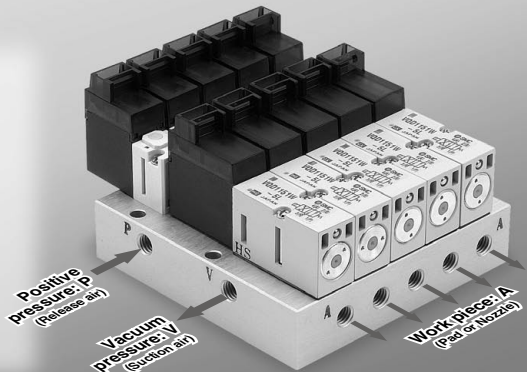
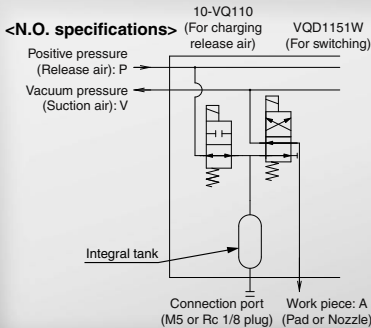
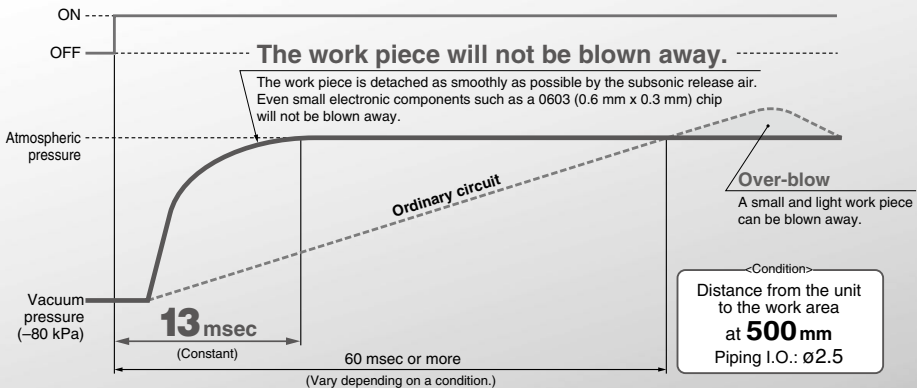

VV061
VV100
V100
S070
VQD
VQD-V
VK
VT

# Vacuum / Release Unit

VQD1000-V Series

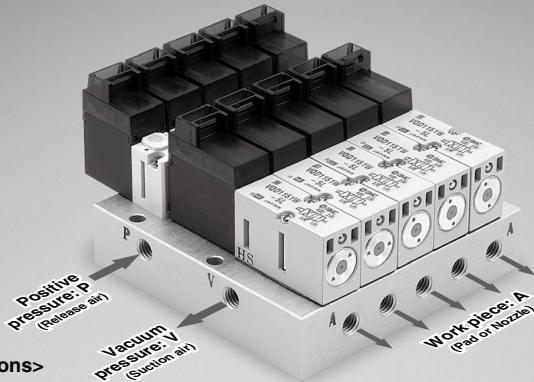

<N.O. specifications>

Positive pressure  
(Release air): P  
Vacuum pressure  
(Suction air): V

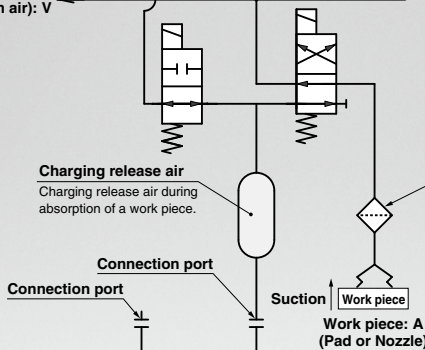

**Charging release air**  
Charging release air during  
absorption of a work piece.

**Connection port**

**Suction**  
Work piece: A  
(Pad or Nozzle)

## Suction filter can be cleaned.

If you energize the VQD1151W, you can clean the suction filter using positive-pressure air blowing.

### Suction filter

Recommended:  
ZFC050-M5X50  
(Filtration rating 20 μm)



Details ▶ P.1408

When the distance between work pieces is fluctuated.

## Compatible with an atmospheric release pressure circuit

Possible to make it an atmospheric release type by installing a check valve on the connecting port and by setting the release air pressure (P) lower.

(When the release air is running low, the pressure inside the tank changes to vacuum from the positive pressure. In this case, the pressure is rapidly released to the atmosphere due to the check valve.)

Atmospheric pressure  
suction port  
Recommended check valve  
AKH04B-M5

When the release pressure is running low.

## Additionally a tank can be installed.

Possible to add a tank for charging release air in accordance with the distance (volume) between the unit from the work piece.

Added tank  
(using piping materials)

[Example of tank addition]

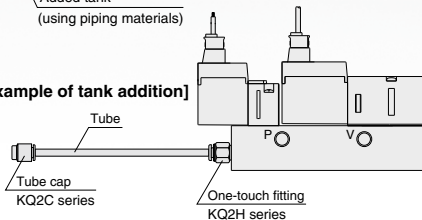

# Working principle

<N.O. specifications>

## When de-energized Vacuum absorption

De-energizing 2 solenoid valves simultaneously  
Charging release air during absorption of a work piece

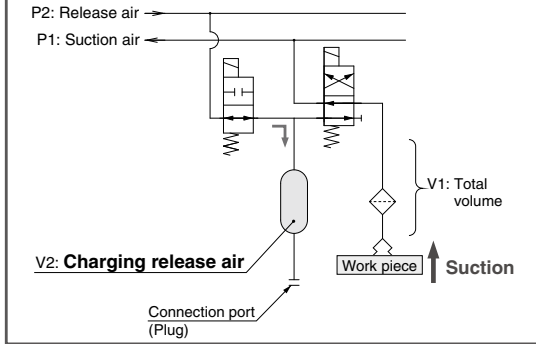

## When energized Release → Shut

Energizing 2 solenoid valves simultaneously  
Release air is discharged and the pressure required for detaching / releasing a work piece turns to atmospheric pressure, resulting in smooth detachment.

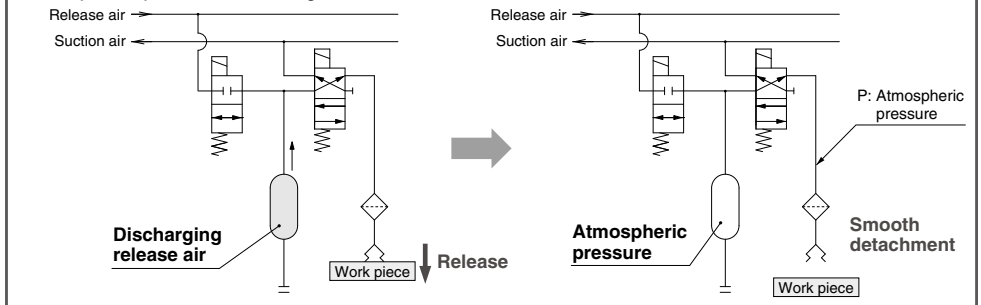

### <Relationship between pressure and a release air tank>

$$P_2 = \frac{(P + 0.1) \times (V_1 + V_2) - (P_1 + 0.1) \times V_1}{V_2} - 0.1$$

P1: Suction vacuum pressure / Negative pressure (MPa)

P2: Release pressure / Positive pressure (MPa)

P: Detaching (Release) pressure (MPa)

\* 0 MPa (atmospheric pressure) is normal.

V1: Total volume from a unit to a work piece (cm<sup>3</sup>)

V2: Volume of a release air tank (cm<sup>3</sup>)

(VQD1000-V type: 0.8 cm<sup>3</sup>)  
(VQD1000-VL type: 3.2 cm<sup>3</sup>)

P2: Release Air Guideline

Distance between the unit and the work area (mm)	300	500	1000	2000	
V1: Total volume from the unit to the work area (cm <sup>3</sup> )	1.67	2.65	5.10	10.01	
P2: Release pressure (MPa)	VQD1000-V	0.19	0.30	0.58	—
	VQD1000-VL	—	0.08	0.14	0.28

<Conditions> • Suction vacuum pressure (P1): -90 kPa (-0.090 MPa)

• Piping tube size: ø4 (I.D. ø2.5)

• Suction filter: When mounting ZFC050-M5X50 (internal volume: 0.2 cm<sup>3</sup>)

### [How to Adjust]

- Adjust P2 release pressure, using a regulator, in accordance with V1 volume. We recommend that you use our precision type, IR series.
- When V1 volume differs in the same manifold, equalize it by adjusting the length or internal diameter of the piping. Even when the piping length is extended a good response is ensured.
- It is recommended for the electrical control of the valve that the release and switching valves are turned ON or OFF at the same time (single signal control). An overshoot of the release air pressure can also be generated by changing the electrical control.

# Vacuum / Release Unit

# VQD1000-V Series



## How to Order

Vacuum /  
Release Unit

VQD1000-V   - 05 - 5  -  -

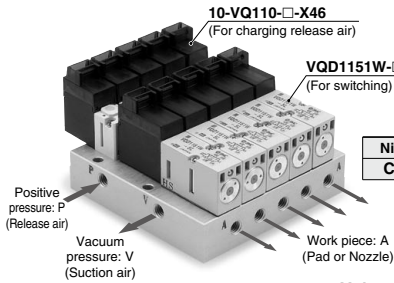

**Valve type**

<b>NII</b>	N.O. specifications
<b>C</b>	N.C. specifications

**Volume of release air tank**

<b>NII</b>	0.8 cm <sup>3</sup>	Guideline: 1 m or shorter distanced from a work piece
<b>L</b>	3.2 cm <sup>3</sup>	Guideline: 1 m or longer distanced from a work piece

Note) Calculate and set the volume using the formula for the relationship between pressure and the release air tank on page 1403.

### Symbol

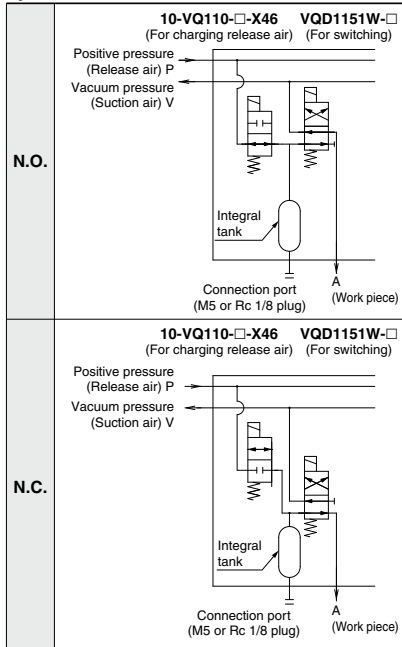

### Stations

<b>01</b>	1 unit (1 station)
<b>02</b>	2 units (2 stations)
⋮	⋮
<b>10</b>	10 units (10 stations)

### Voltage

<b>5</b>	24 VDC
<b>6</b>	12 VDC

### Electrical entry

**NII:** L plug connector  
• Standard type

**LO:** Without L plug connector

**M:** M plug connector  
• The operability of attaching and detaching connectors and manual override will decrease.

**MO:** Without M plug connector

**CE-compliant**

<b>NII</b>	—
<b>Q</b>	CE-compliant

### Blanking plate

<b>NII</b>	Without blanking plate
<b>B1</b>	1 set
<b>B2</b>	2 sets
⋮	⋮
<b>B9</b>	9 sets

Note) The blanking plates are mounted in order starting on the U side of the vacuum/release unit.

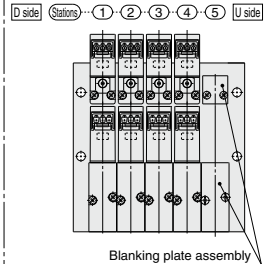

<Example>  
VQD1000-V-05-5-B1

## Specifications

Valve specifications	Valve construction		Direct operated poppet valve	
	Fluid		Air	
	Operating pressure range	Suction (negative pressure)	0 to -100 kPa	
		Release (positive pressure)	0 to 0.7 MPa	
	Response time	N.O. specifications	Suction (OFF)	2 ± 1 msec
		N.C. specifications	Release (ON)	4 ± 1 msec
			Suction (ON)	4 ± 1 msec
		Release (OFF)	2 ± 1 msec	
	Suction flow rate/Sonic conductance		16 L/min/0.27 dm <sup>3</sup> /(s·bar)	
	Manual override		Non-locking push type	
Impact/Vibration resistance		150/30 m/s <sup>2</sup>		
Mounting position		Unrestricted		
Enclosure		Dusttight		
Electric specifications	Coil rated voltage		24 VDC, 12 VDC	
	Allowable rated voltage		±10% of rated voltage	
	Coil insulation type		Class B or equivalent	
	Power consumption	VQD1151W (for switching)	3.2 W energy saving type (Inrush: 3.2 W, Holding: 2.4 W)	
		10-VQ110 (for release supply)	1 W	
	Electrical entry		L/M plug connector (with light/surge voltage suppressor)	

## Replacement Parts

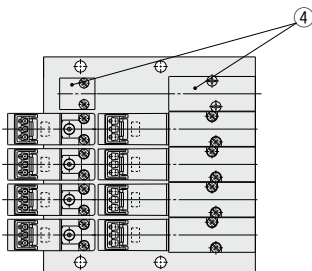
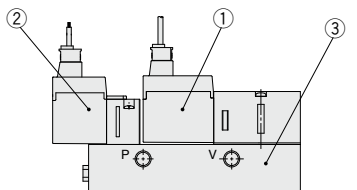

### Product Weight (Formula)

VQD1000-V(C)	W = 80n + 31
VQD1000-V(C)L	W = 84n + 49

W: Weight (g)

N: No. of unit (Stations)

### \* Connector assembly

**AXT661 - 14A -**

#### Lead wire length

Nil	300 mm
6	600 mm
10	1000 mm
20	2000 mm
30	3000 mm

For the product with the lead wire, the lead wire length is 300 mm. To extend the lead wire length to 600 mm or more, select the valve without connector and order the connector assembly separately.

### ① Solenoid valve for switching

**VQD1151W - 5 L -**

Voltage	
5	24 VDC
6	12 VDC

#### CE-compliant

Nil	—
Q	CE-compliant

#### Electrical entry\*

L	L plug connector
LO	L plug connector (Without connector)
M	M plug connector
MO	M plug connector (Without connector)

### ② Solenoid valve for charging release air

**10-VQ110 - 5 L - X46 -**

Voltage	
5	24 VDC
6	12 VDC

#### CE-compliant

Nil	—
Q	CE-compliant

#### Electrical entry\*

L	L plug connector
LO	L plug connector (Without connector)
M	M plug connector
MO	M plug connector (Without connector)

Note) Product with specification on pressure charging A port.

If a standard product is used, external leakage may occur.

### ③ Manifold base unit

**VVQD1000 - 1A - 01 - V**

Stations	
01	1 unit (1 station)
02	2 units (2 stations)
:	:
10	10 units (10 stations)

#### Valve type

Nil	N.O. specifications
C	N.C. specifications

#### Volume of release air tank

Nil	0.8 cm <sup>3</sup>	Guideline: 1 m or shorter distanced from a work piece
L	3.2 cm <sup>3</sup>	Guideline: 1 m or longer distanced from a work piece

### ④ Blanking plate assembly

**VVQD1000 - 10A - V**

Note) One set includes a blanking plate assembly for the solenoid valve for switching and one for the solenoid valve for charging release air.

# VQD1000-V Series

## Dimensions

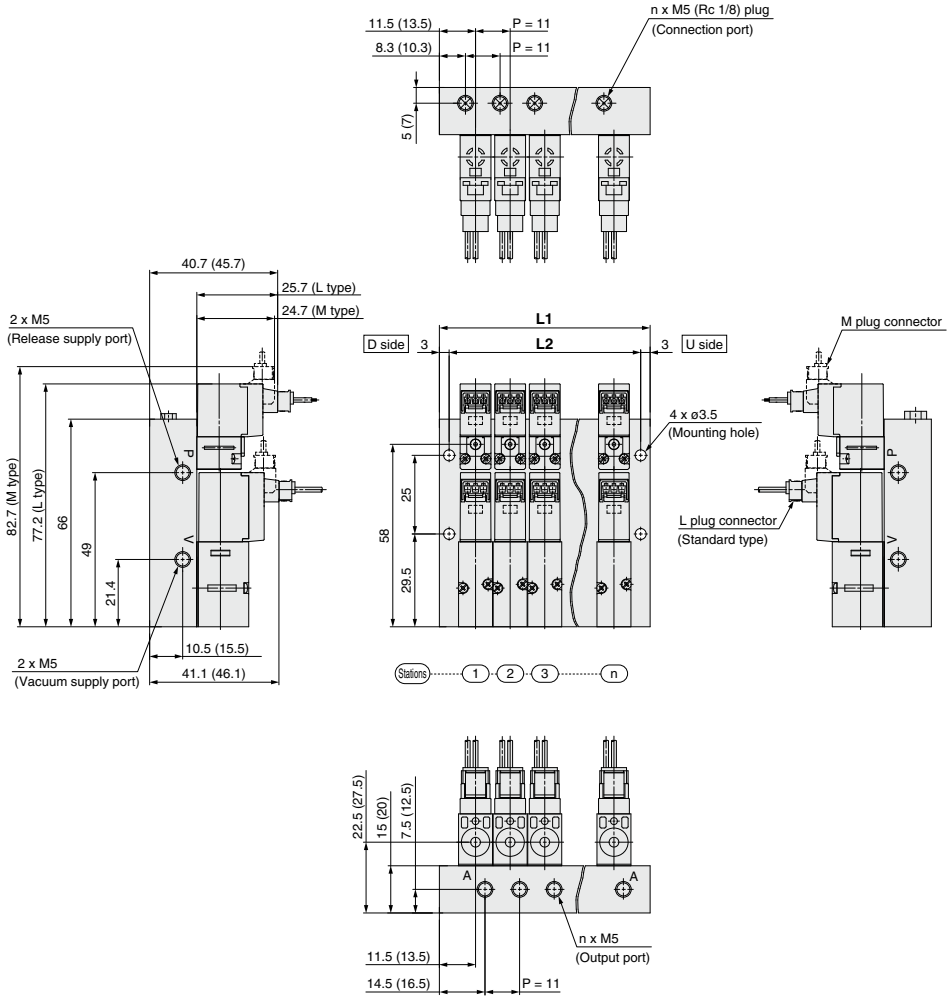

### L: Dimensions (VQD1000-V(C)-□□ / Standard type: Tank volume 0.8 cm<sup>3</sup>)

L \ n	1	2	3	4	5	6	7	8	9	10
L1	23	34	45	56	67	78	89	100	111	122
L2	17	28	39	50	61	72	83	94	105	116

Formula: L1 = 11n + 12, L2 = 11n + 6 (Max. 10 stations)

### L: Dimensions (VQD1000-V(C)L-□□ / Tank volume 3.2 cm<sup>3</sup>)

L \ n	1	2	3	4	5	6	7	8	9	10
L1	25	36	47	58	69	80	91	102	113	124
L2	19	30	41	52	63	74	85	96	107	118

Formula: L1 = 11n + 14, L2 = 11n + 8 (Max. 10 stations)

The dimensions shown in brackets indicate the VQD1000-V(C)L-□□ / tank volume 3.2 cm<sup>3</sup>.



# VQD1000-V Series Specific Product Precautions

Be sure to read this before handling the products.  
Refer to back page 50 for Safety Instructions and pages 3 to 9 for 3/4/5 Port Solenoid Valve Precautions.

## Manual Override Operation

### ⚠ Warning

Connected actuator is started by manual operation. Use the manual override after confirming that there is no danger.

#### ■ Non-locking push type (Tool required)

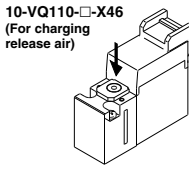
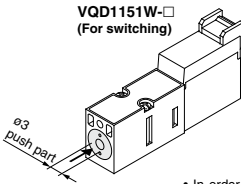

\* In order to turn it ON, push down the manual override button in the direction the arrow (→) indicates until it stops (approx. 0.5 mm), and release it to turn it OFF.

## Wiring Specifications

### ⚠ Caution

VQD1151W-□  
(For switching)

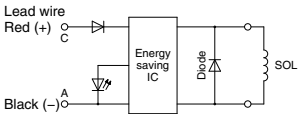

For the VQD1151W specifications (energy saving type), power consumption at holding is reduced with the above circuit. Refer to electrical power waveform as shown below.

<Energy saving type's electrical power waveform>  
(Rated voltage: at 24 VDC)

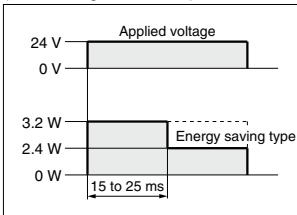

10-VQ110-□-X46  
(For charging release air)

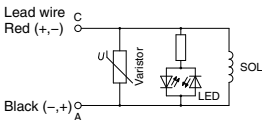

## Continuous Energization

### ⚠ Warning

Coil temperature may get high due to ambient temperature or energizing duration. Do not touch the valve by hand directly. When there is such a dangerous case to be touched by hand directly, install a protective cover.

### ⚠ Caution

When simultaneously energizing 3 stations or more, make sure to place an energized and non-energized valve alternatively.

However, if 3 stations or more need to be energized simultaneously at the time of installing or adjusting, the energizing time should be less than 30 minutes to achieve an energized status not exceeding 50%.

## Valve Mounting

### ⚠ Caution

After confirming the gasket is correctly placed under the valve, securely tighten the bolts with the proper torque shown in the table below.

Proper tightening torque (N·m)
0.18 to 0.25

## How to Use Plug Connector

### ⚠ Caution

#### Attaching and detaching connectors

- To attach a connector, hold the lever and connector unit between your fingers and insert straight onto the pins of the solenoid valve so that the lever's pawl is pushed into the groove and locks.
- To detach a connector, remove the pawl from the groove by pushing the lever downward with your thumb, and pull the connector straight out.

(Note) Gently pull the lead wire, otherwise it may cause contact failure or disconnection.

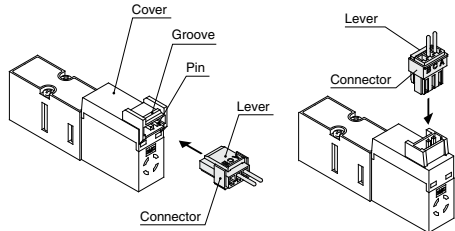

## When Piping to a Product

### ⚠ Caution

When piping to a product, check the supply port, etc.

Also, when tightening the piping tube, clamp the base unit to avoid any undue force from being applied to the valve.

If a force of 120 N or more is applied to the coil especially, the connecting pin may be deformed, resulting in malfunction.

VV061

VV100

V100

S070

VQD

VQD-V

VK

VT

# Related Products



## Suction Filter

### ZFC050-M5X50

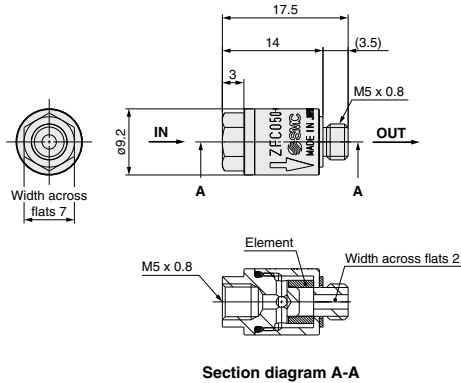

Example of mounting to the manifold base (A port) of the vacuum/release unit VQD1000-V series

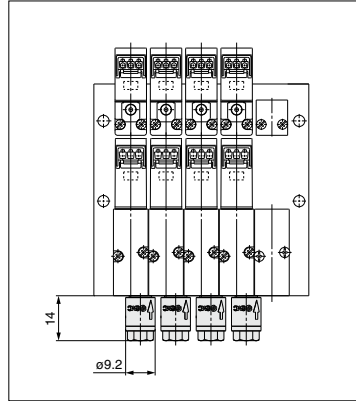

### Specifications

<b>Filtration degree</b>	20 Mm (Nominal)
<b>Fluid</b>	Air
<b>Operating pressure range</b>	-100 to 700 kPa
<b>Ambient temperature</b>	0 to 60°C (No freezing)

Replacement element part no. ... ZFC-EL050-X50

### ⚠ Caution

1. To screw in OUT side port (M5 male thread), tighten by hand before giving it an additional 1/4 turn with a tightening tool.
2. When replacing the element, remove the IN side body using the hexagon surface on the IN side, then replace the element. After replacing the element, tighten the IN side body with the tightening torque 0.5 to 0.7 N·m.
3. As a rule, replace the element when the pressure drops by 20 kPa.