

Metal One-touch Fittings

KQB2 Series

Compact and Light

Dimensions **Approx. 30%** **Shorter**
* Comparison with KQBL06-01S

Weight **Approx. 62%** **Lighter**
* Comparison with KQBL06-01S

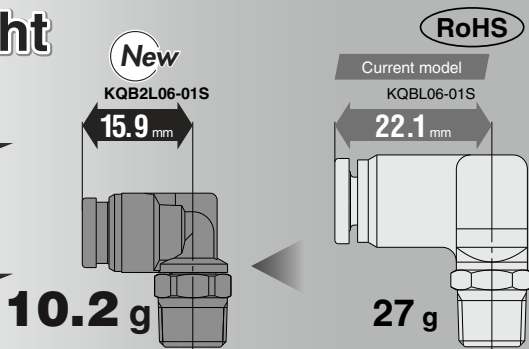

Fluid temperature **-5 to 150°C**

Connection thread **M, R, Rc, UNF, NPT, G**

Applicable tubing material **FEP • PFA • Nylon • Soft nylon
Polyurethane • Polyolefin**

Electroless nickel plated
(Brass parts)

Grease-free

KQ2

KQB2

KS
KX

KM

KF

M

H/DL
L/LL

KC

KK

KK130

DM

KDM

KB

KR

KA

KQG2

KG

KFG2

MS

KKA

KP

LQ

MQR

T

IDK

Variations

	Applicable tubing O.D. (mm)						
	ø3.2	ø4	ø6	ø8	ø10	ø12	ø16
M5	●	●	●				
R1/8	●	●	●	●	●		
G1/8	●	●	●	●	●		
R1/4	●	●	●	●	●	●	
G1/4		●	●	●	●	●	
R3/8			●	●	●	●	●
G3/8			●	●	●	●	●
R1/2				●	●	●	●
G1/2				●	●	●	●
No thread	●	●	●	●	●	●	●

	Applicable tubing O.D. (inch)					
	ø1/8"	ø5/32"	ø1/4"	ø5/16"	ø3/8"	ø1/2"
10-32 UNF	●	●	●			
NPT1/8	●	●	●	●	●	
NPT1/4	●	●	●	●	●	●
NPT3/8		●	●	●	●	●
NPT1/2			●	●	●	●
No thread	●	●	●	●	●	●

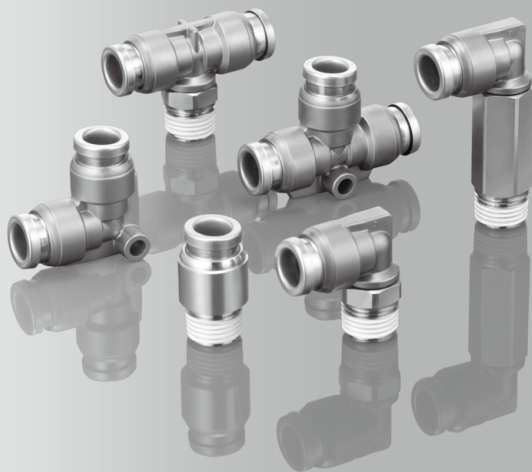

Compact and light

Dimensions: Approx. **30%** shorter

* Comparison with KQBL06-01S

Weight: Approx. **62%** lighter

* Comparison with KQBL06-01S

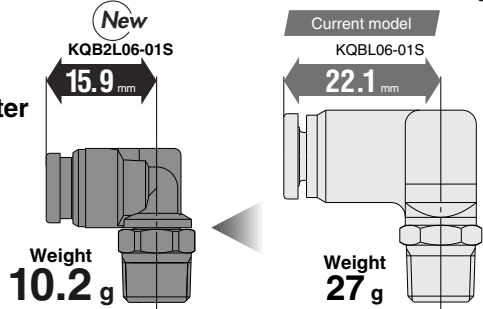

○ Inch size x UNF/NPT thread,
Metric size x G thread

○ Applicable tubing size

∅3.2 to ∅16, ∅1/8" to ∅1/2"

○ Connection thread: M, R, Rc, UNF, NPT, G

○ Fluid temperature: **-5 to 150°C**

○ Grease-free

○ Applicable tubing material

FEP • PFA • Nylon • Soft nylon
Polyurethane • Polyolefin

○ Electroless nickel plated
(Brass parts)

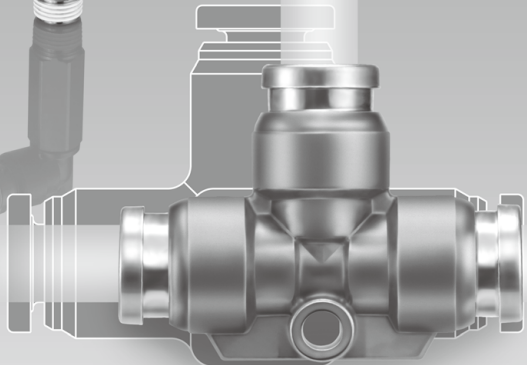
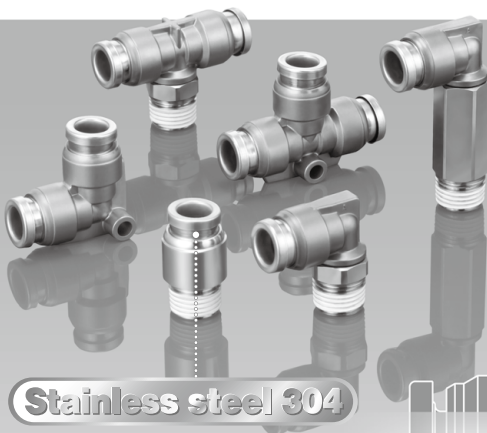
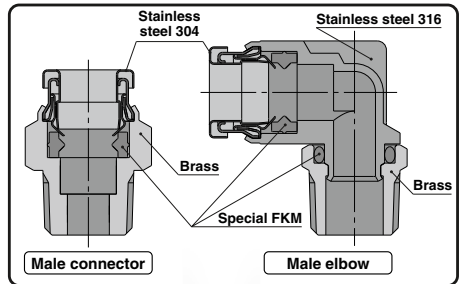

Variations

Male Connector **KQB2H**



Metric
R thread ...P. 143
G thread ...P. 156
Inch P. 150

Hexagon Socket Head Male Connector **KQB2S**



Metric
R thread ...P. 143
G thread ...P. 156
Inch P. 150

Straight Union **KQB2H**



Metric ...P. 143
Inch P. 150

Male Elbow **KQB2L**



Metric
R thread ...P. 144
G thread ...P. 157
Inch P. 151

Male Branch Tee **KQB2T**



Metric
R thread ...P. 144
G thread ...P. 157
Inch P. 151

Union Elbow **KQB2L**



Metric ...P. 145
Inch P. 151

Bulkhead Union **KQB2E**



Metric ...P. 145
Inch P. 152

Union Tee **KQB2T**



Metric ...P. 145
Inch P. 152

Union "Y" **KQB2U**



Metric ...P. 145
Inch P. 152

Different Diameter Tee **KQB2T**



Metric ...P. 146
Inch P. 152

Plug-in Reducer **KQB2R**



Metric ...P. 146
Inch P. 152

Different Diameter Straight **KQB2H**



Metric ...P. 146
Inch P. 153

Different Diameter Union "Y" **KQB2U**



Metric ...P. 146
Inch P. 153

Bulkhead Connector **KQB2E**



Metric
Rc thread ...P. 147
G thread ...P. 158
Inch P. 153

Extended Male Elbow **KQB2W**



Metric
R thread ...P. 147
G thread ...P. 158
Inch P. 153

Female Connector **KQB2F**



Metric
Rc thread ...P. 148
G thread ...P. 158
Inch P. 154

Plug **KQB2P**



Metric ...P. 148
Inch P. 154

KQ2

KQB2

**KS
KX**

KM

KF

M

**H/DL
L/LL**

KC

KK

KK130

DM

KDM

KB

KR

KA

KQG2

KG

KFG2

MS

KKA

KP

LQ

MQR

T

IDK

Metal One-touch Fittings

Applicable Tubing: Metric Size, Connection Thread: M, R, Rc

KQB2 Series

RoHS



Applicable Tubing

Tubing material	FEP, PFA, Nylon, Soft nylon, Polyurethane, Polyolefin
Tubing O.D.	ø3.2, ø4, ø6, ø8, ø10, ø12, ø16

Specifications

Fluid	Air, Water ^{Note 2)}
Operating pressure range ^{Note 1)}	-100 kPa to 1 MPa ^{Note 3)}
Proof pressure	3.0 MPa
Ambient and fluid temperature ^{Note 4)}	-5 to 150°C (No freezing) ^{Note 3)}
Lubricant	Grease-free specification
Seal on the threads	With sealant

- Note 1) Avoid using in a vacuum holding application such as a leak tester, since there is leakage.
 Note 2) Deionized water is not recommended for use as it may affect the material used in the fittings. In addition, it is known to degrade the water quality.
 Note 3) Check the operating pressure range and operating temperature range of the tubing.
 Note 4) It is recommended that you use the inner sleeve in the following conditions (Except ø3.2):
- When using in an environment where the fluid temperature changes drastically.
 - When using at a high temperature.

* Temperature Condition of Mounting the Inner Sleeve

Tubing	Temperature
FEP tubing/TH Series	80°C or more
Super PFA tubing/TL Series	120°C or more

Spare Parts

Description	Tubing O.D.	Part no.	Material
Gasket	—	M-5G3	Stainless steel 316, Special FKM
Bulkhead nut	ø3.2	KQB223-P01	C3604 (Electroless nickel plated)
	ø4		
	ø6		
	ø8		
	ø10		
	ø12	KQB212-P01	
	ø16	KQB216-P01	

Cross Reference Table of the Inner Sleeve

Tubing O.D.	Tubing material			Applicable inner sleeve	
	TUS (Soft polyurethane)	TH/THI (FEP)	TL/TIL (Super PFA)	Part no.	Length
ø4	—	TH0402	—	TJ-0402	18
	TUS0425	TH0425	—	TJ-0425	18
	—	—	TL0403	TJ-0403	18
ø6	TUS0604	TH0604	TL0604	TJ-0604	19
	TUS0805	—	—	TJ-0805	20.5
ø8	—	TH0806	TL0806	TJ-0806	20.5
	TUS1065	—	—	TJ-1065	23
ø10	—	TH1075	—	TJ-1075	23
	—	TH1008	TL1008	TJ-1008	24
	TUS1208	—	—	TJ-1208	24
ø12	—	TH1209	—	TJ-1209	24
	—	TH1210	TL1210	TJ-1210	24
	—	—	—	—	—

* C2700 + Electroless nickel plated is used for the TJ series.

Construction

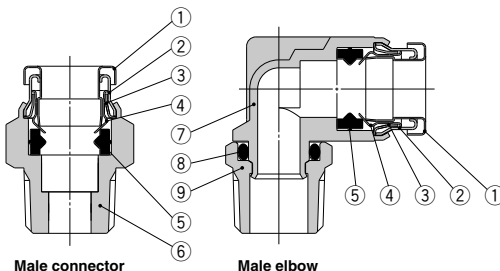

Component Parts

No.	Description	Material
1	Release button	Stainless steel 304
2	Guide 1	Stainless steel 304
3	Guide 2	Stainless steel 304
4	Chuck	Stainless steel 304
5	Seal	Special FKM (Fluoro coated)
6	Male connector body	C3604 (Electroless nickel plated)
7	Male elbow body	Stainless steel 316
8	O-ring	Special FKM (Fluoro coated)
9	Stud	C3604 (Electroless nickel plated)

Metal One-touch Fittings **KQB2 Series**

Applicable Tubing: Metric Size, Connection Thread: M, R, Rc

Dimensions

Male Connector: KQB2H



Applicable tubing O.D. (mm)	Connection thread R, M	Model	H (Width across flat)	øD	L	A*	M	Note 1) Effective area (mm ²)	Weight (g)
ø3.2	M5 x 0.8	KQB2H23-M5	8	—	16.5	13.5	12	3	3.4
	1/8	KQB2H23-01S	10		15.4	12.3		3.4	6
	1/4	KQB2H23-02S	14		21	16.3		5.6	17.8
ø4	M5 x 0.8	KQB2H04-M5	10	—	17.1	14.1	12.6	4	5.3
	1/8	KQB2H04-01S			15.3	12.2		5.6	5.6
	1/4	KQB2H04-02S			14	20.9		16.2	5.6
ø6	M5 x 0.8	KQB2H06-M5	12	—	19.1	16.1	13.6	4	8
	1/8	KQB2H06-01S	14		18.1	15		7.3	7.3
	1/4	KQB2H06-02S	14		20.8	16.1		13.1	15.2
	3/8	KQB2H06-03S	17		23	17.9		28.8	28.8
ø8	1/8	KQB2H08-01S	14	—	24.5	21.4	16.1	26.1	13.5
	1/4	KQB2H08-02S			22.3	17.6		26	26
	3/8	KQB2H08-03S			17	23.7		18.6	26
ø10	1/8	KQB2H10-01S	17	—	25.5	22.4	17	26.1	19.8
	1/4	KQB2H10-02S			27.9	23.2		41.5	22.7
	3/8	KQB2H10-03S			23	17.9		21.6	21.6
	1/2	KQB2H10-04S			22	28.6		22.2	53.9
ø12	1/4	KQB2H12-02S	19	—	30.5	25.8	18.6	58.3	28.8
	3/8	KQB2H12-03S			24.7	19.6		21.5	21.5
	1/2	KQB2H12-04S			22	28.7		22.3	47
ø16	3/8	KQB2H16-03S	24	24.6	33.6	28.5	20.8	81	48.3
	1/2	KQB2H16-04S			29.5	23.1		113	39.2

* Reference dimensions after installation for R thread
Note 1) Value of FEP tubing.

Value of nylon tubing for ø16 only.

(M5)

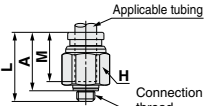

(R)

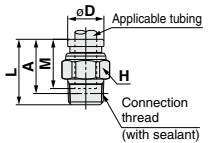

Hexagon Socket Head Male Connector: KQB2S



Applicable tubing O.D. (mm)	Connection thread R, M	Model	H (Width across flat)	Note 1) øD	L	A*	M	Note 2) Effective area (mm ²)	Weight (g)
ø3.2	M5 x 0.8	KQB2S23-M5	2	9	16.5	13.5	12	3	4
ø4	M5 x 0.8	KQB2S04-M5	2	9	17.1	14.1	12.6	4	3.9
	1/8	KQB2S04-01S	3	10	20.4	17.3		4.1	7.9
ø6	M5 x 0.8	KQB2S06-M5	2	12	19.6	16.6	13.6	4	7.8
	1/8	KQB2S06-01S	4		20.6	17.5		10	9.1
	1/4	KQB2S06-02S	4		14	20.6		15.9	10.7
ø8	1/8	KQB2S08-01S	5	14	24.7	21.6	16.1	17.2	13
	1/4	KQB2S08-02S	6		22.9	18.2		23.3	13.5
	3/8	KQB2S08-03S	6		17	23.1		18	24
ø10	1/8	KQB2S10-01S	5	17	25.6	22.5	17	17.2	18.6
	1/4	KQB2S10-02S	8		27.5	22.8		39	22
	3/8	KQB2S10-03S	8		24	18.9		39.2	39.2
	1/2	KQB2S10-04S	22		24	17.6		46	26
ø12	1/4	KQB2S12-02S	8	19	30.6	25.9	18.6	60	20.2
	3/8	KQB2S12-03S	10		24.9	19.8		35.3	35.3
	1/2	KQB2S12-04S	22		24.9	18.5		81	43.6
ø16	3/8	KQB2S16-03S	10	24.6	33.2	28.1	20.8	113	43.6
	1/2	KQB2S16-04S	12		29.4	23		81	40.3

* Reference dimensions after installation for R thread

Note 1) For the ø16, this dimension refers to the O.D. of the release button.

Note 2) Value of FEP tubing.

Value of nylon tubing for ø16 only.

(M5)

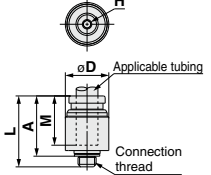

(R)

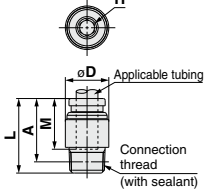

Straight Union: KQB2H



Applicable tubing O.D. (mm)	Model	øD Note 1)	L	M	Note 2) Effective area (mm ²)	Weight (g)
ø3.2	KQB2H23-00	9	25	12	3.4	6.8
ø4	KQB2H04-00	9	26.2	12.6	5.6	6.8
ø6	KQB2H06-00	12	28.2	13.6	13.1	12
ø8	KQB2H08-00	14	33.2	16.1	26.1	17.4
ø10	KQB2H10-00	17	35	17	41.5	27.2
ø12	KQB2H12-00	19	38.2	18.6	58.3	33.7
ø16	KQB2H16-00	24.6	42.6	20.8	113	56.1

Note 1) For the ø16, this dimension refers to the O.D. of the release button.

Note 2) Value of FEP tubing.

Value of nylon tubing for ø16 only.

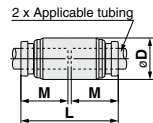

KQ2

KQB2

KS
KX

KM

KF

M

H/DL
L/LL

KC

KK

KK130

DM

KDM

KB

KR

KA

KQG2

KG

KFG2

MS

KKA

KP

LQ

MQR

T

IDK

KQB2 Series

Applicable Tubing: Metric Size, Connection Thread: M, R, Rc

Dimensions

Male Elbow: KQB2L



Applicable tubing O.D. (mm)	Connection Thread R, M	Model	H (With across flange)	Note 1) ϕ D	L1	L2	A*	M	Note 2) Effective area (mm ²)	Weight (g)
ϕ 3.2	M5 x 0.8	KQB2L23-M5	8	8.3	13.1	14.8	16	12	2.6	6.5
	1/8	KQB2L23-01S	10		13.6	14.9	15.9		3	8
	1/4	KQB2L23-02S	14		13.7	15.2	16.8		3.5	7
ϕ 4	M5 x 0.8	KQB2L04-M5	8	9.1	13.7	15.2	16.8	12.6	3.5	7
	1/8	KQB2L04-01S	10		14.4	15.3	16.7		4.2	8.6
	1/4	KQB2L04-02S	14		14.7	16.3	19		3.5	9
ϕ 6	M5 x 0.8	KQB2L06-M5	8	11.4	14.7	16.3	19	13.6	3.5	9
	1/8	KQB2L06-01S	10		15.9	16.4	21.2		11.4	10.2
	1/4	KQB2L06-02S	14		20.2	21.6	22.2		31.2	14.8
ϕ 8	3/8	KQB2L06-03S	17	13.7	18.6	18.3	22	16.1	21.6	20.8
	1/4	KQB2L08-02S	14		19.1	21.5	23.6		32.8	14.8
	3/8	KQB2L08-03S	17		20	22.9	24.6		21.6	20.4
ϕ 10	1/8	KQB2L10-01S	12	16.6	21	19.7	24.9	17	35.2	23.7
	1/4	KQB2L10-02S	14		22.9	26.5	34.5		62.6	27.4
	3/8	KQB2L10-03S	17		24.3	27.5	34.5		50.2	34.3
ϕ 12	1/2	KQB2L10-04S	22	18.7	28.5	30.4	37	18.6	71	47
	1/4	KQB2L12-02S	14		22.6	24	28.6		100	62.6
	3/8	KQB2L12-03S	17		23.6	25.3	29.5		71	47
ϕ 16	1/2	KQB2L12-04S	22	24.6	29.5	32.4	37	20.8	71	47
	3/8	KQB2L16-03S	19		26.3	28	34.5		100	62.6
	1/2	KQB2L16-04S	22		27.3	31.8	37		100	62.6

* Reference dimensions after installation for R thread

Note 1) For the ϕ 16, this dimension refers to the O.D. of the release button.

Note 2) Value of FEP tubing.

Value of nylon tubing for ϕ 16 only.

(M5)

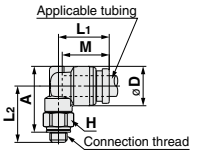

(R)

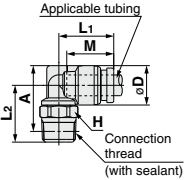

Male Branch Tee: KQB2T



Applicable tubing O.D. (mm)	Connection Thread R, M	Model	H (With across flange)	Note 1) ϕ D	L1	L2	A*	M	Note 2) Effective area (mm ²)	Weight (g)
ϕ 3.2	M5 x 0.8	KQB2T23-M5	8	8.3	13.1	14.8	16	12	3.2	8.2
	1/8	KQB2T23-01S	10		13.6	14.9	15.9		3.4	9.6
	1/4	KQB2T23-02S	14		13.7	15.2	16.8		4.5	9.1
ϕ 4	M5 x 0.8	KQB2T04-M5	8	9.1	13.7	15.2	16.8	12.6	4.5	9.1
	1/8	KQB2T04-01S	10		14.4	15.3	16.7		6	10.6
	1/4	KQB2T04-02S	14		14.7	16.3	19		4.5	12.1
ϕ 6	M5 x 0.8	KQB2T06-M5	8	11.4	14.7	16.3	19	13.6	4.5	12.1
	1/8	KQB2T06-01S	10		15.9	16.4	21.2		13.9	22.5
	1/4	KQB2T06-02S	14		20.2	21.6	22.2		35	20
ϕ 8	3/8	KQB2T06-03S	17	13.7	18.6	18.3	22	16.1	26.3	26.1
	1/4	KQB2T08-02S	14		19.1	21.5	23.6		38	28.6
	3/8	KQB2T08-03S	17		20	22.9	24.6		40.8	31.5
ϕ 10	1/8	KQB2T10-01S	12	16.6	21	19.7	24.9	17	40.8	28.6
	1/4	KQB2T10-02S	14		22.9	26.5	31.5		70.4	38.1
	3/8	KQB2T10-03S	17		24.3	27.5	34.5		57.2	39.7
ϕ 12	1/2	KQB2T10-04S	22	18.7	28.5	30.4	37	18.6	71	70.8
	1/4	KQB2T12-02S	14		22.6	24	28.6		71	64.4
	3/8	KQB2T12-03S	17		23.6	25.3	29.5		100	79
ϕ 16	1/2	KQB2T12-04S	22	24.6	29.5	32.4	37	20.8	71	64.4
	3/8	KQB2T16-03S	19		26.3	28	34.5		100	79
	1/2	KQB2T16-04S	22		27.3	31.8	37		100	79

* Reference dimensions after installation for R thread

Note 1) For the ϕ 16, this dimension refers to the O.D. of the release button.

Note 2) Value of FEP tubing.

Value of nylon tubing for ϕ 16 only.

(M5)

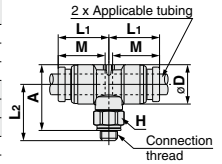

(R)

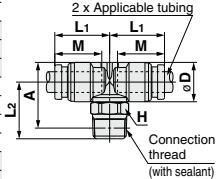

Metal One-touch Fittings **KQB2 Series**

Applicable Tubing: Metric Size, Connection Thread: M, R, Rc

Dimensions

Union Elbow: KQB2L



Applicable tubing O.D. (mm)	Model	Note 1) ϕD	L	A	Q	M	ϕN	ϕO	Note 2) Effective area (mm ²)	Weight (g)
$\phi 3.2$	KQB2L23-00	8.3	13.6	19.3	2.9	12	3.2	5.6	3	6.3
$\phi 4$	KQB2L04-00	9.1	14.6	20.5	3.1	12.6	3.2	5.6	4.2	7.4
$\phi 6$	KQB2L06-00	11.4	16.6	23	3.6	13.6	3.2	5.6	11.4	11
$\phi 8$	KQB2L08-00	13.7	20.1	29.1	5	16.1	4.2	8	21.6	20.2
$\phi 10$	KQB2L10-00	16.6	22	31.7	5.7	17	4.2	8	35.2	29.6
$\phi 12$	KQB2L12-00	18.7	24.6	35	6.4	18.6	4.2	8	50.2	37.1
$\phi 16$	KQB2L16-00	24.6	28.8	40.5	7.7	20.8	4.2	8	100	59.7

Note 1) For the $\phi 16$, this dimension refers to the O.D. of the release button.

Note 2) Value of FEP tubing.

Value of nylon tubing for $\phi 16$ only.

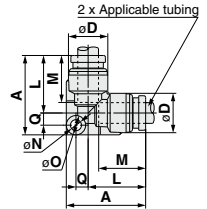

Bulkhead Union: KQB2E



Applicable tubing O.D. (mm)	Model	T (M)	H (Width across flat)	L	Mounting hole	M	Note) Effective area (mm ²)	Weight (g)
$\phi 3.2$	KQB2E23-00	M10 x 1	12	32.2	11	12	3.4	14.8
$\phi 4$	KQB2E04-00	M10 x 1	12	32.4	11	12.6	5.6	14.7
$\phi 6$	KQB2E06-00	M14 x 1	17	35.4	15	13.6	13.1	29.2
$\phi 8$	KQB2E08-00	M15 x 1	19	38.8	16	16.1	26.1	34.9
$\phi 10$	KQB2E10-00	M18 x 1	21	40	19	17	41.5	47.1
$\phi 12$	KQB2E12-00	M20 x 1	24	42.4	21	18.6	58.3	58.7
$\phi 16$	KQB2E16-00	M27 x 1	30	46.8	28	20.8	113	107.2

Note) Value of FEP tubing.

Value of nylon tubing for $\phi 16$ only.

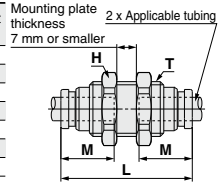

Union Tee: KQB2T



Applicable tubing O.D. (mm)	Model	Note 1) ϕD	L	A	Q	M	ϕN	ϕO	Note 2) Effective area (mm ²)	Weight (g)
$\phi 3.2$	KQB2T23-00	8.3	13.6	20.5	4.1	12	3.2	5.6	3.4	7.9
$\phi 4$	KQB2T04-00	9.1	14.6	21.8	4.4	12.6	3.2	5.6	6.4	9.5
$\phi 6$	KQB2T06-00	11.4	16.6	24.6	5.2	13.6	3.2	5.6	13.4	14.2
$\phi 8$	KQB2T08-00	13.7	20.1	31.1	7	16.1	4.2	8	25.6	24.4
$\phi 10$	KQB2T10-00	16.6	22	34	8	17	4.2	8	40	36.8
$\phi 12$	KQB2T12-00	18.7	24.6	37.7	9.1	18.6	4.2	8	57.4	47
$\phi 16$	KQB2T16-00	24.6	28.8	43.4	10.6	20.8	4.2	8	100	75.5

Note 1) For the $\phi 16$, this dimension refers to the O.D. of the release button.

Note 2) Value of FEP tubing.

Value of nylon tubing for $\phi 16$ only.

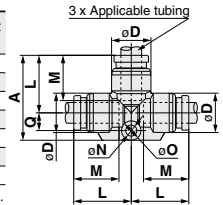

Union "Y": KQB2U



Applicable tubing O.D. (mm)	Model	Note 1) ϕD	W	L1	L2	P	M	ϕN	ϕO	Note 2) Effective area (mm ²)	Weight (g)
$\phi 3.2$	KQB2U23-00	8.3	16.4	29	11	8.1	12	3.2	5.6	3.4	9.2
$\phi 4$	KQB2U04-00	9.1	18.2	30.4	11.3	9.1	12.6	3.2	5.6	4.2	11.1
$\phi 6$	KQB2U06-00	11.4	22.9	34.9	12.2	11.5	13.6	3.2	5.6	13.4	18.8
$\phi 8$	KQB2U08-00	13.7	28.3	40.1	14.1	14.6	16.1	4.2	8	25.6	29.7
$\phi 10$	KQB2U10-00	16.6	34.2	44	14.4	17.6	17	4.2	8	40	47.4
$\phi 12$	KQB2U12-00	18.7	38.5	48.4	15.8	19.8	18.6	4.2	8	57.4	62.1
$\phi 16$	KQB2U16-00	24.6	49.3	56.6	17.3	26	20.8	4.2	8	113	110.2

Note 1) For the $\phi 16$, this dimension refers to the O.D. of the release button.

Note 2) Value of FEP tubing.

Value of nylon tubing for $\phi 16$ only.

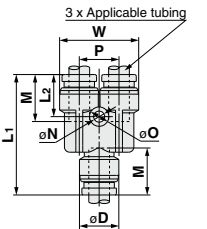

KQ2

KQB2

KS
KX

KM

KF

M

H/DL
L/L

KC

KK

KK130

DM

KDM

KB

KR

KA

KQG2

KG

KFG2

MS

KKA

KP

LQ

MQR

T

IDK

KQB2 Series

Applicable Tubing: Metric Size, Connection Thread: M, R, Rc

Dimensions

Different Diameter Tee: KQB2T



Applicable tubing O.D. (mm)		Model	Note 1)		L1	L2	L3	Q	M1	M2	øN	øO	Note 2) Effective area (mm ²)	Weight (g)
a	b		øD1	øD2										
ø3.2	ø4	KQB2T23-04	9.1	8.3	14.2	14.1	21.1	4.1	12.6	12	3.2	5.6	3.8	8.5
ø4	ø6	KQB2T04-06	11.4	9.1	15.6	15.7	22.8	4.4	13.6	12.6	3.2	5.6	7.1	11
ø6	ø8	KQB2T06-08	13.7	11.4	19.1	17.7	29.5	6.4	16.1	13.6	4.2	8	16.4	20
ø8	ø10	KQB2T08-10	16.6	13.7	21	21.2	32.1	7.1	17	16.1	4.2	8	36	29.8
ø10	ø12	KQB2T10-12	18.7	16.6	23.6	23.1	35.7	8.1	18.6	17	4.2	8	56	41.3
ø12	ø16	KQB2T12-16	24.6	18.7	26.8	26.7	39.9	9.1	20.8	18.6	4.2	8	108.5	58

Note 1) For the ø16, this dimension refers to the O.D. of the release button.
Note 2) Value of FEP tubing.

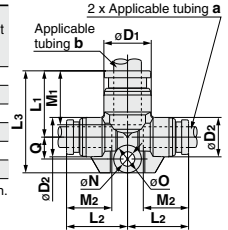

Plug-in Reducer: KQB2R



Applicable tubing O.D. (mm)	Applicable fitting size ød	Model	øD	L	A	M	Note) Effective area (mm ²)	Weight (g)
ø3.2	ø4	KQB2R23-04	9	32.9	20.3	12	3.4	4.9
ø4	ø6	KQB2R04-06	9	34.4	20.8	12.6	5.6	7
ø6	ø8	KQB2R06-08	12	38.4	22.3	13.6	13.1	12.7
ø8	ø10	KQB2R08-10	14	41.9	24.9	16.1	26.1	19.2
ø10	ø12	KQB2R10-12	17	44.8	26.2	17	41.5	27.8
ø12	ø16	KQB2R12-16	19	42.9	22.1	18.6	58.3	37.2

Note) Value of FEP tubing.

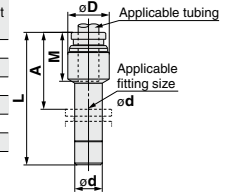

Different Diameter Straight: KQB2H



Applicable tubing O.D. (mm)		Model	øD Note 1)	L	M1	M2	Note 2) Effective area (mm ²)	Weight (g)
a	b							
ø3.2	ø4	KQB2H23-04	9	25.6	12	12.6	3.4	6.8
ø4	ø6	KQB2H04-06	12	27.2	12.6	13.6	5.6	12.1
ø6	ø8	KQB2H06-08	14	30.7	13.6	16.1	13.1	17.1
ø8	ø10	KQB2H08-10	17	34.1	16.1	17	26.1	27.2
ø10	ø12	KQB2H10-12	19	36.6	17	18.6	41.5	34.8
ø12	ø16	KQB2H12-16	24.6	40.4	18.6	20.8	58.3	57.3

Note 1) For the ø16, this dimension refers to the O.D. of the release button.
Note 2) Value of FEP tubing.

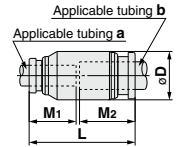

Different Diameter Union "Y": KQB2U



Applicable tubing O.D. (mm)		Model	Note 1) øD	L1	L2	P	W	M1	M2	øN	øO	Note 2) Effective area (mm ²)	Weight (g)
a	b												
ø3.2	ø4	KQB2U23-04	9.1	27	10.8	8.1	16.4	12	12.6	3.2	5.6	3.2	8.5
ø4	ø6	KQB2U04-06	11.4	29.3	11.2	9.1	18.2	12.6	13.6	3.2	5.6	4.2	11.9
ø6	ø8	KQB2U06-08	13.7	33.7	12.2	11.5	22.9	13.6	16.1	4.2	8	13.4	19.3
ø8	ø10	KQB2U08-10	16.6	38.3	13.8	14.6	28.3	16.1	17	4.2	8	25.6	32
ø10	ø12	KQB2U10-12	18.7	43	14	17.6	34.2	17	18.6	4.2	8	40	47.6
ø12	ø16	KQB2U12-16	24.6	47.4	15.6	19.8	38.5	18.6	20.8	4.2	8	57.4	67.6

Note 1) For the ø16, this dimension refers to the O.D. of the release button.
Note 2) Value of FEP tubing.

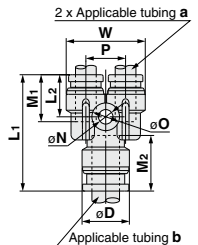

Metal One-touch Fittings **KQB2 Series**

Applicable Tubing: Metric Size, Connection Thread: M, R, Rc

Dimensions

Bulkhead Connector: KQB2E



Applicable tubing O.D. (mm)	Connection Thread Rc	Model	T (M)	Width across flat		L1	L2	Mounting hole	M	Note 1 Effective area (mm ²)	Weight (g)
				H1	H2						
ø3.2	1/4	KQB2E23-02	M10 x 1	17	12	31	14.8	11	12	3.4	27.5
	1/8	KQB2E04-01		14	12	25.8	9.7				16.9
ø4	1/4	KQB2E04-02	M10 x 1	17	12	30.9	14.8	11	12.6	5.6	27.1
	1/8	KQB2E06-01		17	17	24.2	6.1				25
ø6	1/4	KQB2E06-02	M14 x 1	17	17	31.6	13.5	15	13.6	13.1	33.2
	3/8	KQB2E06-03		19	17	33	14.9				34.8
ø8	1/8	KQB2E08-01		17	19	26.3	6.9				28.7
	1/4	KQB2E08-02	M15 x 1	19	19	32.4	13	16	16.1	26.1	34.2
	3/8	KQB2E08-03		19	34	34	14.6				35.9
ø10	1/4	KQB2E10-02	M18 x 1	19	21	31.6	11.6	19	17	41.5	44
	3/8	KQB2E10-03		24	24	33.6	13.6				40.2
ø12	3/8	KQB2E12-03	M20 x 1	21	24	34	12.8	21	18.6	58.3	52
	1/2	KQB2E12-04		29	29	39.6	18.4				62.5
ø16	3/8	KQB2E16-03	M27 x 1	29	30	35.3	11.2	28	20.8	96	111
	1/2	KQB2E16-04		40.6	40.6	40.6	16.5			113	118.2

Note) Value of FEP tubing.
Value of nylon tubing for ø16 only.

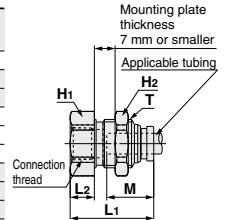

Extended Male Elbow: KQB2W



Applicable tubing O.D. (mm)	Connection thread R, M	Model	H (Width across flat)	Note 1) øD	L1	L2	A*	M	Note 2) Effective area (mm ²)	Weight (g)
ø4	1/8	KQB2W23-01S	10	8.3	13.6	31.3	32.3	12	2.8	15.3
	1/4	KQB2W23-02S	14			35.1	34.5			34.7
ø6	M5 x 0.8	KQB2W04-M5	8		13.7	31.6	33.2		3	14.1
	1/8	KQB2W04-01S	10	9.1	14.4	31.7	33.1	12.6	4	16.2
ø8	1/4	KQB2W04-02S	14			35.5	35.3			35.6
	M5 x 0.8	KQB2W06-M5	8		14.7	32.7	35.4		3	16
	1/8	KQB2W06-01S	10	11.4	15.9	36.6	37.6	13.6	10.9	17.8
ø10	1/4	KQB2W06-02S	14			38	38.6			37.2
	3/8	KQB2W06-03S	17			38	38.6			60.3
	1/8	KQB2W08-01S	12		18.6	37	40.7			28.9
ø12	1/4	KQB2W08-02S	14	13.7	19.1	40.2	42.3	16.1	20.5	39.2
	3/8	KQB2W08-03S	17			41.6	43.3			63.7
	1/4	KQB2W10-02S	14			46.6	50.2			42.1
ø16	3/8	KQB2W10-03S	17	16.6	21	45.9	49.1	17	33.5	64.5
	1/2	KQB2W10-04S	22			50.1	52			123
ø12	1/4	KQB2W12-02S	14		22.6	47.7	52.3			46
	3/8	KQB2W12-03S	17	18.7	23.6	49	53.2	18.6	47.7	58.2
ø16	1/2	KQB2W12-04S	22			53.2	56.1			118
	3/8	KQB2W16-03S	19	24.6	26.3	57.6	64.1	20.8	71	89.6
	1/2	KQB2W16-04S	22		27.3	61.4	66.6		100	116

* Reference dimensions after installation for R thread
Note 1) For the ø16, this dimension refers to the O.D. of the release button.
Note 2) Value of FEP tubing.
Value of nylon tubing for ø16 only.

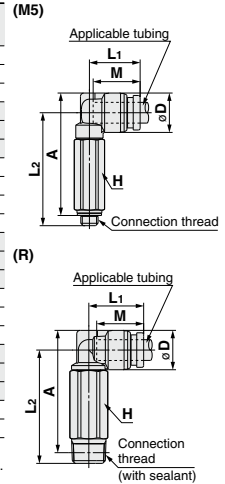

- KQ2
- KQB2**
- KS
- KX
- KM
- KF
- M
- H/DL
- L/LL
- KC
- KK
- KK130
- DM
- KDM
- KB
- KR
- KA
- KQG2
- KG
- KFG2
- MS
- KKA
- KP
- LQ
- MQR
- T
- IDK

KQB2 Series

Applicable Tubing: Metric Size, Connection Thread: M, R, Rc

Dimensions

Female Connector: KQB2F

Applicable tubing O.D. (mm)	Connection Thread Rc	Model	H (Width across flat)	Note 1) ϕD	L1	L2	M	Note 2) Effective area (mm ²)	Weight (g)
$\phi 3.2$	1/8	KQB2F23-01	12	8	23.3	9.8	12	3.4	9.3
	1/8	KQB2F04-01	12	8.7	23.7	9.8	12.6	5.6	9.7
$\phi 4$	1/4	KQB2F04-02	17		28.7	13.2			22.7
	$\phi 6$	1/8	KQB2F06-01	12	11.1	24.2	10	13.6	13.1
1/4		KQB2F06-02	17	29.2		13.4	24.3		
$\phi 8$	3/8	KQB2F06-03	19	13.4	30.6	14.2	16.1	26.1	25.8
	1/8	KQB2F08-01	14		26.3	9.6			17.1
$\phi 10$	1/4	KQB2F08-02	17	18.5	31.3	13.7	17	41.5	26.8
	3/8	KQB2F08-03	19		32.7	14.4			28.4
$\phi 12$	1/2	KQB2F10-03	19	16.4	31.6	13.9	18.6	58.3	30.3
	3/8	KQB2F10-02	17		33	14.7			32
$\phi 16$	1/2	KQB2F12-02	19	24	32.6	13.3	20.8	81	39.4
	3/8	KQB2F12-03	19		34	14.7			33.9
$\phi 16$	1/2	KQB2F16-04	24	24.6	39.3	18.4	20.8	113	52.9
	3/8	KQB2F16-03	24		35.3	13.5			62.8
$\phi 16$	1/2	KQB2F16-04	24	24.6	40.6	18.8	20.8	113	59.9

Note 1) For the $\phi 10$, $\phi 12$, and $\phi 16$, this dimension refers to the O.D. of the release button.

Note 2) Value of FEP tubing.

Value of nylon tubing for $\phi 16$ only.

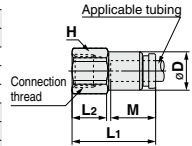

Plug: KQB2P

Applicable fitting size ϕd	Model	ϕD	L	A	Weight (g)
$\phi 3.2$	KQB2P-23	5	28.9	16.9	2.8
$\phi 4$	KQB2P-04	6	29.6	17	4.3
$\phi 6$	KQB2P-06	8	30.8	17.2	9
$\phi 8$	KQB2P-08	10	33.7	17.6	16.3
$\phi 10$	KQB2P-10	12	34.6	17.6	25.4
$\phi 12$	KQB2P-12	14	36.5	17.9	37.8
$\phi 16$	KQB2P-16	18	38.6	17.8	69.2

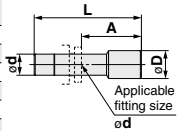

Related Equipment

Spatter cover

(Applicable tubing: FR soft nylon, FR double layer, FR three-layer)

Applicable tubing O.D. (mm)	Model
$\phi 6$	KQB2-06C-X1124
$\phi 8$	KQB2-08C-X1124
$\phi 10$	KQB2-10C-X1124



* Since the spatter cover is designed for multi-layer (double layer, three-layer) tubing, sufficient effects cannot be obtained in foreign matter flow-in or followability for single-layer tubing.

* The cover can be attached regardless of the single-layer/multi-layer tubing.

* Cannot be used for union "Y" (KQB2U) 2-port side.

Metal One-touch Fittings

Applicable Tubing: Inch Size, Connection Thread: UNF, NPT

KQB2 Series

RoHS



Applicable Tubing

Tubing material	FEP, PFA, Nylon, Soft nylon, Polyurethane, Polyolefin
Tubing O.D.	ø1/8", ø5/32", ø1/4", ø5/16", ø3/8", ø1/2"

Specifications

Fluid	Air, Water ^{Note 2)}
Operating pressure range ^{Note 1)}	-100 kPa to 1 MPa ^{Note 3)}
Proof pressure	3.0 MPa
Ambient and fluid temperature ^{Note 4)}	-5 to 150°C (No freezing) ^{Note 3)}
Lubricant	Grease-free specification
Seal on the threads	With sealant

Note 1) Avoid using in a vacuum holding application such as a leak tester, since there is leakage.
 Note 2) Deionized water is not recommended for use as it may affect the material used in the fittings. In addition, it is known to degrade the water quality.
 Note 3) Check the operating pressure range and operating temperature range of the tubing.
 Note 4) It is recommended that you use the inner sleeve in the following conditions (Except ø1/8"):

- When using in an environment where the fluid temperature changes drastically.
- When using at a high temperature.

* Temperature Condition of Mounting the Inner Sleeve

Tubing	Temperature
FEP tubing/TH Series	80°C or more
Super PFA tubing/TL Series	120°C or more

Spare Parts

Description	Tubing O.D.	Part no.	Material
Gasket	—	M-5G3	Stainless steel 316, Special FKM
Bulkhead nut	ø1/8" ø5/32"	KQB201-P01	C3604 (Electroless nickel plated)
	ø1/4"	KQB207-P01	
	ø5/16"	KQB209-P01	
	ø3/8"	KQB211-P01	
	ø1/2"	KQB213-P01	

Cross Reference Table of the Inner Sleeve

Tubing O.D.	Tubing material		Applicable inner sleeve	
	TH/THI (FEP)	TL/TIL (Super PFA)	Part no.	Length
ø5/32"	TH0402	—	TJ-0402	18
	TH0425	—	TJ-0425	18
ø1/4"	—	TL0403	TJ-0403	18
	TIHB07	TIL07	TJ-0604	19
ø5/16"	TIHA07	—	TJ-0746	19
	TH0806	TL0806	TJ-0806	20.5
ø3/8"	TIHB11	TIL11	TJ-1065	23
	TIHA11	—	TJ-1107	23
ø1/2"	TIH13	TIL13	TJ-1395	24

* C2700 + Electroless nickel plated is used for the TJ series.

Construction

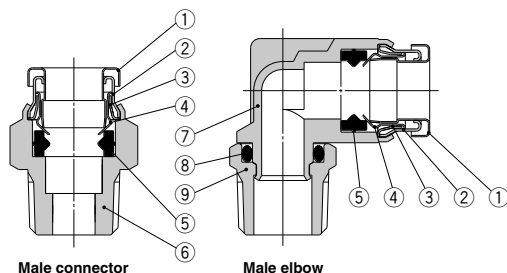

Component Parts

No.	Description	Material
1	Release button	Stainless steel 304
2	Guide 1	Stainless steel 304
3	Guide 2	Stainless steel 304
4	Chuck	Stainless steel 304
5	Seal	Special FKM (Fluoro coated)
6	Male connector body	C3604 (Electroless nickel plated)
7	Male elbow body	Stainless steel 316
8	O-ring	Special FKM (Fluoro coated)
9	Stud	C3604 (Electroless nickel plated)

KQB2 Series

Applicable Tubing: Inch Size, Connection Thread: UNF, NPT

Dimensions

Male Connector: KQB2H



Applicable tubing O.D. (inch)	Connection thread UNF, NPT	Model	H (Width across flat)	L	A*	M	Note) Effective area (mm ²)	Weight (g)	
ø1/8"	10-32UNF	KQB2H01-32	8	16.5	13.5	12	3	3.5	
	1/8	KQB2H01-N01S	11.11	17.1	13.9		3.4	7.9	
	1/4	KQB2H01-N02S	14.29	20.9	16.5		18		
ø5/32"	10-32UNF	KQB2H03-32	11.11	17.1	14.1	12.6	4	6.5	
	1/8	KQB2H03-N01S		17	13.8		5.6	7.4	
	1/4	KQB2H03-N02S		14.29	20.9		16.5	17.5	
ø1/4"	10-32UNF	KQB2H07-32	12.7	19	16	13.5	4	9	
	1/8	KQB2H07-N01S	20	16.8	13.1		9.8		
	1/4	KQB2H07-N02S	14.29	20.6			16.2	15.1	
	3/8	KQB2H07-N03S	17.46	23.8			19.1	31	
ø5/16"	1/8	KQB2H09-N01S	14.29	24.2	21	16.1	26.1	13.8	
	1/4	KQB2H09-N02S		23.1	18.7		14.9		
	3/8	KQB2H09-N03S		17.46	24.6		19.9	28.3	
ø3/8"	1/8	KQB2H11-N01S	17.46	25	21.8	16.6	26.1	21.5	
	1/4	KQB2H11-N02S		26.3	21.9		22.3		
	3/8	KQB2H11-N03S		23.6	18.9		24.4		
	1/2	KQB2H11-N04S		22.23	28.3		21.9	55	
	1/4	KQB2H13-N02S		30.5	26.1		39.4		
ø1/2"	3/8	KQB2H13-N03S	22.23	28.4	23.7	18.5	58.3	36.8	
	1/2	KQB2H13-N04S		22	22		46.1		

* Reference dimensions after installation for NPT thread
Note) Value of FEP tubing.

(10-32UNF)

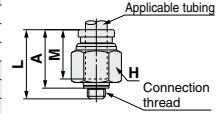

(NPT)

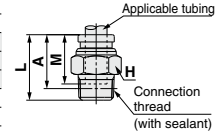

Hexagon Socket Head Male Connector: KQB2S



Applicable tubing O.D. (inch)	Connection thread UNF, NPT	Model	H (Width across flat)	øD	L	A*	M	Note) Effective area (mm ²)	Weight (g)
ø1/8"	10-32UNF	KQB2S01-32	2	9	16.5	13.5	12	3	3.9
	10-32UNF	KQB2S03-32	2	9	17.1	14.1	12.6	4	3.9
ø5/32"	1/8	KQB2S03-N01S	2.78	11	21.4	18.2		13.5	4.1
	10-32UNF	KQB2S07-32	2	12	19.5	16.5	4		7.5
	1/8	KQB2S07-N01S	4.76	14	20.5	17.3	10		8.5
1/4	KQB2S07-N02S	18		21.5	16.1	10.7	14.1		
3/8	KQB2S07-N03S	14		24.7	21.5	17.2	12.6		
ø5/16"	1/4	KQB2S09-N02S	5.56	14	23.1	18.7	16.1	23.3	13.4
	3/8	KQB2S09-N03S	6.35	18	23.1	18.4		17.2	24.7
	1/8	KQB2S11-N01S	5.56	17	25.2	22		17.2	18.7
ø3/8"	1/4	KQB2S11-N02S	6.35	17	27.1	22.7	16.6	39	22.2
	3/8	KQB2S11-N03S		18	23.6	18.9		25	
	1/2	KQB2S11-N04S		22	23.6	17.2		40.6	
ø1/2"	1/4	KQB2S13-N02S	8	20	30.5	26.1	18.5	46	27.9
	3/8	KQB2S13-N03S	9.53	20	29.4	24.7		60	30.4
	1/2	KQB2S13-N04S		22	25.5	19.1		36.5	

* Reference dimensions after installation for NPT thread
Note) Value of FEP tubing.

(10-32UNF)

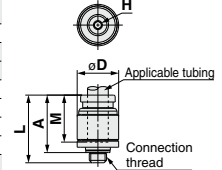

(NPT)

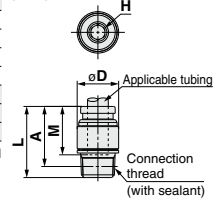

Straight Union: KQB2H



Applicable tubing O.D. (inch)	Model	øD	L	M	Note) Effective area (mm ²)	Weight (g)
ø1/8"	KQB2H01-00	9	25	12	3.4	6.8
ø5/32"	KQB2H03-00	9	26.2	12.6	5.6	6.8
ø1/4"	KQB2H07-00	12	28	13.5	13.1	11.5
ø5/16"	KQB2H09-00	14	33.2	16.1	26.1	17.4
ø3/8"	KQB2H11-00	16	34.2	16.6	41.5	23.7
ø1/2"	KQB2H13-00	20	38	18.5	58.3	37

Note) Value of FEP tubing.

2 x Applicable tubing

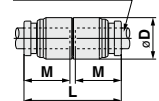

Metal One-touch Fittings **KQB2 Series**

Applicable Tubing: Inch Size, Connection Thread: UNF, NPT

Dimensions

Male Elbow: KQB2L



Applicable tubing O.D. (inch)	Connection thread UNF, NPT	Model	H (With across flat)	øD	L1	L2	A*	M	Note) Effective area (mm ²)	Weight (g)
ø1/8"	10-32UNF	KQB2L01-32	8	8.3	13.1	14.8	16	12	2.6	6.5
	1/8	KQB2L01-N01S	11.11		13.6	14.9	15.8		3	8.8
	1/4	KQB2L01-N02S	14.29		13.7	15.2	16.8		3.5	7
ø5/32"	10-32UNF	KQB2L03-32	8	9.1	14.4	15.3	16.6	12.6	4.2	9.7
	1/8	KQB2L03-N01S	11.11		14.4	15.3	16.6		4.2	18.5
	1/4	KQB2L03-N02S	14.29		14.7	16.5	19.3		3.5	9.1
ø1/4"	10-32UNF	KQB2L07-32	8	11.7	15.9	16.6	19.2	13.5	11.4	11.4
	1/8	KQB2L07-N01S	11.11		22.2	23.3	33.7			
	1/4	KQB2L07-N02S	14.29		18.6	18.3	21.9		15.8	
ø5/16"	10-32UNF	KQB2L09-N01S	12.7	13.7	19.1	21.5	23.9	16.1	21.6	21.9
	1/4	KQB2L09-N02S	14.29		23.3	25.4	35			
	3/8	KQB2L09-N03S	17.46		20	19.4	24.2		21.6	20.5
ø3/8"	10-32UNF	KQB2L11-N01S	12.7	16	21	22.6	26.2	16.6	35.2	23.9
	1/4	KQB2L11-N02S	14.29		24.4	27.7	35.8			
	3/8	KQB2L11-N03S	17.46		28.2	29.8	63.1			
ø1/2"	10-32UNF	KQB2L13-N01S	12.7	19.6	22.7	24.4	29.8	18.5	50.2	30.1
	1/4	KQB2L13-N02S	14.29		26.1	31.2	37.9			
	3/8	KQB2L13-N03S	17.46		29.9	33.3	63.8			

* Reference dimensions after installation for NPT thread
Note) Value of FEP tubing.

(10-32UNF)

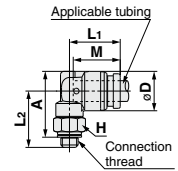

(NPT)

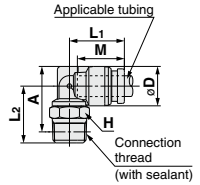

Male Branch Tee: KQB2T



Applicable tubing O.D. (inch)	Connection thread UNF, NPT	Model	H (With across flat)	øD	L1	L2	A*	M	Note) Effective area (mm ²)	Weight (g)
ø1/8"	10-32UNF	KQB2T01-32	8	8.3	13.1	14.8	16	12	3.2	8.2
	1/8	KQB2T01-N01S	11.11		13.6	14.9	15.8		3.4	10.6
	1/4	KQB2T01-N02S	14.29		13.7	15.2	16.8		4.5	9.1
ø5/32"	10-32UNF	KQB2T03-32	8	9.1	14.4	15.3	16.6	12.6	6	11.6
	1/8	KQB2T03-N01S	11.11		14.4	15.3	16.6		6	20.5
	1/4	KQB2T03-N02S	14.29		14.7	16.5	19.3		4.5	12.3
ø1/4"	10-32UNF	KQB2T07-32	8	11.7	15.9	16.6	19.2	13.5	13.9	14.9
	1/8	KQB2T07-N01S	11.11		22.2	23.3	37.1			
	1/4	KQB2T07-N02S	14.29		18.6	18.3	21.9		21.2	
ø5/16"	10-32UNF	KQB2T09-N01S	12.7	13.7	19.1	21.5	23.9	16.1	26.3	27.1
	1/4	KQB2T09-N02S	14.29		23.3	25.4	40.3			
	3/8	KQB2T09-N03S	17.46		20	19.4	24.2		28.1	
ø3/8"	10-32UNF	KQB2T11-N01S	12.7	16	21	22.6	26.2	16.6	40.8	31.1
	1/4	KQB2T11-N02S	14.29		24.4	27.7	43.1			
	3/8	KQB2T11-N03S	17.46		28.2	29.8	70.4			
ø1/2"	10-32UNF	KQB2T13-N01S	12.7	19.6	22.7	24.4	29.8	18.5	57.2	41.8
	1/4	KQB2T13-N02S	14.29		26.1	31.2	49			
	3/8	KQB2T13-N03S	17.46		29.9	33.3	74.9			

* Reference dimensions after installation for NPT thread
Note) Value of FEP tubing.

(10-32UNF)

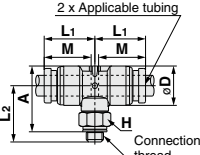

(NPT)

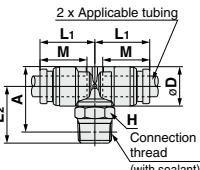

Union Elbow: KQB2L



Applicable tubing O.D. (inch)	Model	øD	L	A	Q	M	øN	øO	Note) Effective area (mm ²)	Weight (g)
ø1/8"	KQB2L01-00	8.3	13.6	19.3	2.9	12	3.2	5.6	3	6.3
ø5/32"	KQB2L03-00	9.1	14.6	20.5	3.1	12.6	3.2	5.6	4.2	7.4
ø1/4"	KQB2L07-00	11.7	16.7	23.2	3.7	13.5	3.2	5.6	11.4	11.5
ø5/16"	KQB2L09-00	13.7	20.1	29.1	5	16.1	4.2	8	21.6	20.2
ø3/8"	KQB2L11-00	16	21.4	31.1	5.7	16.6	4.2	8	35.2	28.2
ø1/2"	KQB2L13-00	19.6	24.9	35.3	6.4	18.5	4.2	8	50.2	41.7

Note) Value of FEP tubing.

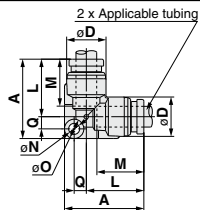

- KQ2
- KQB2**
- KS
- KX
- KM
- KF
- M
- H/DL
- L/L
- KC
- KK
- KK130
- DM
- KDM
- KB
- KR
- KA
- KQG2
- KG
- KFG2
- MS
- KKA
- KP
- LQ
- MQR
- T
- IDK

KQB2 Series

Applicable Tubing: Inch Size, Connection Thread: UNF, NPT

Dimensions

Bulkhead Union: KQB2E



Applicable tubing O.D. (inch)	Model	T (UNF)	H (Width across flat)	L	Mounting hole	M	Note) Effective area (mm ²)	Weight (g)
ø1/8"	KQB2E01-00	7/16-20UNF	14.29	34.2	12.5	12	3.4	21.8
ø5/32"	KQB2E03-00	7/16-20UNF	14.29	34.4	12.5	12.6	5.6	21.6
ø1/4"	KQB2E07-00	1/2-20UNF	17.46	36.2	14	13.5	13.1	30.2
ø5/16"	KQB2E09-00	5/8-18UNF	22.23	41.2	17	16.1	26.1	43.9
ø3/8"	KQB2E11-00	3/4-16UNF	22.23	42.4	20.5	16.6	41.5	64.2
ø1/2"	KQB2E13-00	7/8-14UNF	25.4	47	23.5	18.5	58.3	94.2

(Note) Value of FEP tubing.

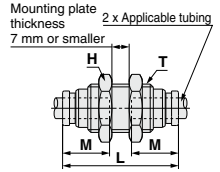

Union Tee: KQB2T



Applicable tubing O.D. (inch)	Model	øD	L	A	Q	M	øN	øO	Note) Effective area (mm ²)	Weight (g)
ø1/8"	KQB2T01-00	8.3	13.6	20.5	4.1	12	3.2	5.6	3.4	7.9
ø5/32"	KQB2T03-00	9.1	14.6	21.8	4.4	12.6	3.2	5.6	6.4	9.5
ø1/4"	KQB2T07-00	11.7	16.7	24.7	5.2	13.5	3.2	5.6	13.4	14.7
ø5/16"	KQB2T09-00	13.7	20.1	31.1	7	16.1	4.2	8	25.6	24.4
ø3/8"	KQB2T11-00	16	21.4	33.4	8	16.6	4.2	8	40	34.7
ø1/2"	KQB2T13-00	19.6	24.9	37.9	9	18.5	4.2	8	57.4	52.3

(Note) Value of FEP tubing.

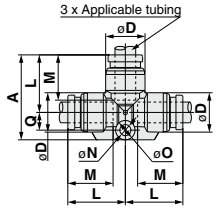

Union "Y": KQB2U



Applicable tubing O.D. (inch)	Model	øD	W	L1	L2	P	M	øN	øO	Note) Effective area (mm ²)	Weight (g)
ø1/8"	KQB2U01-00	8.3	16.4	29	11	8.1	12	3.2	5.6	3.4	9.2
ø5/32"	KQB2U03-00	9.1	18.2	30.4	11.3	9.1	12.6	3.2	5.6	4.2	11.1
ø1/4"	KQB2U07-00	11.7	23.9	34.5	12.1	12.2	13.5	3.2	5.6	13.4	19.6
ø5/16"	KQB2U09-00	13.7	28.3	40.1	14.1	14.6	16.1	4.2	8	25.6	29.7
ø3/8"	KQB2U11-00	16	33.2	42.2	14	17.2	16.6	4.2	8	40	43.1
ø1/2"	KQB2U13-00	19.6	40.2	47.3	15.8	20.6	18.5	4.2	8	57.4	66.4

(Note) Value of FEP tubing.

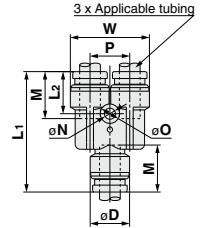

Different Diameter Tee: KQB2T



Applicable tubing O.D. (inch)	Model	øD1	øD2	L1	L2	L3	Q	M1	M2	øN	øO	Note) Effective area (mm ²)	Weight (g)
a ø1/8" b ø5/32"	KQB2T01-03	9.1	8.3	14.2	14.1	21.1	4.1	12.6	12	3.2	5.6	3.8	8.5
ø5/32" ø1/4"	KQB2T03-07	11.7	9.1	15.5	15.9	22.7	4.4	13.5	12.6	3.2	5.6	7.1	11.7
ø1/4" ø5/16"	KQB2T07-09	13.7	11.7	19.3	17.6	29.6	6.3	16.1	13.5	4.2	8	16.4	20.2
ø5/16" ø3/8"	KQB2T09-11	16	13.7	20.6	21	31.7	7.1	16.6	16.1	4.2	8	36	28.9
ø3/8" ø1/2"	KQB2T11-13	19.6	16	23.3	23	35.4	8.1	18.5	16.6	4.2	8	56	41.8

(Note) Value of FEP tubing.

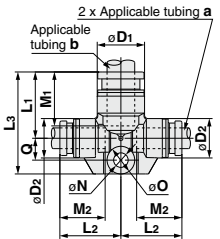

Plug-in Reducer: KQB2R



Applicable tubing O.D. (inch)	Applicable fitting size ød	Model	øD	L	A	M	Note) Effective area (mm ²)	Weight (g)
ø1/8"	ø5/32"	KQB2R01-03	9	32.9	20.3	12	3.4	4.9
ø5/32"	ø1/4"	KQB2R03-07	9	33.7	20.2	12.6	5.6	7.4
ø1/4"	ø5/16"	KQB2R07-09	12	38.4	22.3	13.5	13.1	12.5
ø5/16"	ø3/8"	KQB2R09-11	14	41.6	25	16.1	26.1	17.7
ø3/8"	ø1/2"	KQB2R11-13	17	39.8	21.3	16.6	41.5	24.7

(Note) Value of FEP tubing.

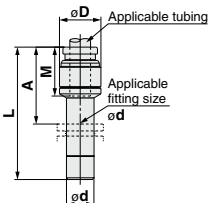

Metal One-touch Fittings **KQB2 Series**

Applicable Tubing: Inch Size, Connection Thread: UNF, NPT

Dimensions

Different Diameter Straight: KQB2H



Applicable tubing O.D. (inch)		Model	øD	L	M1	M2	Note) Effective area (mm ²)	Weight (g)
a	b							
ø1/8"	ø5/32"	KQB2H01-03	9	25.6	12	12.6	3.4	6.8
ø5/32"	ø1/4"	KQB2H03-07	12	27.1	12.6	13.5	5.6	11.9
ø1/4"	ø5/16"	KQB2H07-09	14	30.6	13.5	16.1	13.1	16.8
ø5/16"	ø3/8"	KQB2H09-11	16	33.7	16.1	16.6	26.1	23.9
ø3/8"	ø1/2"	KQB2H11-13	20	36.1	16.6	18.5	41.5	38.8

Note) Value of FEP tubing.

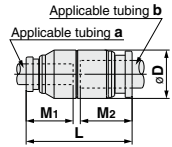

Different Diameter Union "Y": KQB2U



Applicable tubing O.D. (inch)		Model	øD	L1	L2	P	W	M1	M2	øN	øO	Note) Effective area (mm ²)	Weight (g)
a	b												
ø1/8"	ø5/32"	KQB2U01-03	9.1	27	10.8	8.1	16.4	12	12.6	3.2	5.6	3.2	8.5
ø5/32"	ø1/4"	KQB2U03-07	11.7	28.8	11.4	9.1	18.2	12.6	13.5	3.2	5.6	4.2	11.8
ø1/4"	ø5/16"	KQB2U07-09	13.7	33.8	12	12.2	23.9	13.5	16.1	4.2	8	13.4	20
ø5/16"	ø3/8"	KQB2U09-11	16	38.3	13.8	14.6	28.3	16.1	16.6	4.2	8	25.6	31
ø3/8"	ø1/2"	KQB2U11-13	19.6	40.5	13.7	17.2	33.2	16.6	18.5	4.2	8	40	45

Note) Value of FEP tubing.

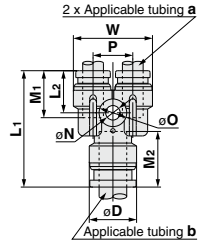

Bulkhead Connector: KQB2E



Applicable tubing O.D. (inch)	Connection thread NPT	Model	T (UNF)	Width across flat		L1	L2	Mounting hole	M	Note) Effective area (mm ²)	Weight (g)
				H1	H2						
ø1/8"	1/4	KQB2E01-N02	7/16-20UNF	17.46	14.29	32.8	15.3	12.5	12	3.4	34.1
ø5/32"	1/4	KQB2E03-N02	7/16-20UNF	17.46	14.29	32.6	15.3	12.5	12.6	5.6	33.5
ø1/4"	1/4	KQB2E07-N02	12-20UNF	17.46	17.46	33.1	14.8	14	13.5	13.1	36.5
ø5/16"	3/8	KQB2E09-N03	5/8-18UNF	22.23	22.23	35.8	15.1	17	16.1	26.1	56.1
ø3/8"	3/8	KQB2E11-N03	3/4-18UNF	22.23	22.23	35.2	13.7	20.5	16.6	41.5	62.9
ø1/2"	3/8	KQB2E13-N03	7/8-14UNF	23.81	25.4	34.6	11	23.5	18.5	58.3	76.6
	1/2	KQB2E13-N04	7/8-14UNF	23.81	25.4	42.2	18.6				80.2

Note) Value of FEP tubing.

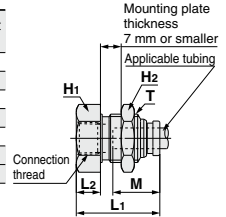

Extended Male Elbow: KQB2W



Applicable tubing O.D. (inch)	Connection thread NPT	Model	H (Width across flat)	øD	L1	L2	A*	M	Note) Effective area (mm ²)	Weight (g)
1/4	KQB2W01-N02S	14.29	35.4	35.1	4	20.3				
ø5/32"	1/8	KQB2W03-N01S	11.11	9.1			14.4	32	33.3	12.6
	1/4	KQB2W03-N02S	14.29		35.8	35.9				
ø1/4"	1/8	KQB2W07-N01S	11.11	11.7	15.9	33.3	35.9	13.5	10.9	39.9
	1/4	KQB2W07-N02S	14.29							
ø5/16"	3/8	KQB2W09-N01S	12.7	13.7	18.6	34.7	38.3	16.1	20.5	30.4
	1/4	KQB2W09-N02S	14.29							
ø3/8"	3/8	KQB2W09-N03S	17.46	16	21	42	44.1	16.6	33.5	44.9
	1/4	KQB2W11-N02S	14.29							
ø1/2"	3/8	KQB2W11-N03S	17.46	19.6	22.7	45.4	48.7	18.5	47.7	51.1
	1/2	KQB2W11-N04S	22.23							
ø1/2"	1/4	KQB2W13-N02S	14.29	23.7	22.7	49	54.4	18.5	47.7	51.1
	3/8	KQB2W13-N03S	17.46							
1/2	KQB2W13-N04S	22.23	54.5	57.9						125.9

* Reference dimensions after installation of NPT thread
Note) Value of FEP tubing.

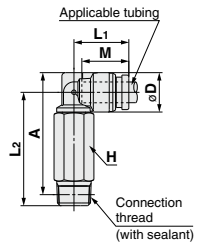

KQ2

KQB2

KS
KX

KM

KF

M

H/DL
L/L

KC

KK

KK130

DM

KDM

KB

KR

KA

KQG2

KG

KFG2

MS

KKA

KP

LQ

MQR

T

IDK

KQB2 Series

Applicable Tubing: Inch Size, Connection Thread: UNF, NPT

Dimensions

Female Connector: KQB2F

Applicable tubing O.D. (inch)	Connection thread NPT	Model	H (Width across flat)	Note 1) ϕD	L1	L2	M	Note 2) Effective area (mm ²)	Weight (g)
$\phi 1/8"$	1/8	KQB2F01-N01	12.7	8	24.1	10.4	12	3.4	11.3
	1/4	KQB2F01-N02	17.46		29.1	13.7			25.4
$\phi 5/32"$	1/8	KQB2F03-N01	12.7	8.7	24.6	10.5	12.6	5.6	11.8
	1/4	KQB2F03-N02	17.46		29.6	13.8			25.9
$\phi 1/4"$	1/8	KQB2F07-N01	12.7	11.2	25	10.7	13.5	13.1	13
	1/4	KQB2F07-N02	17.46		30	14.1			27.5
	3/8	KQB2F07-N03	22.23		31.2	14.6			41.1
$\phi 5/16"$	1/8	KQB2F09-N01	14.29	13.4	27.2	10.3	16.1	26.1	18.8
	1/4	KQB2F09-N02	17.46		32.2	14.3			30.1
	3/8	KQB2F09-N03	22.23		33.4	14.8			44
$\phi 3/8"$	1/4	KQB2F11-N02	17.46	16	32.1	14.4	16.6	41.5	32.9
	3/8	KQB2F11-N03	22.23		33.3	14.9			47
	1/2	KQB2F11-N04	23.81		38.6	18.6			50.4
$\phi 1/2"$	3/8	KQB2F13-N03	22.23	19.3	34.6	14.7	18.5	58.3	51.3
	1/2	KQB2F13-N04	23.81		39.9	18.8			55.1

Note 1) For the $\phi 3/8"$, this dimension refers to the O.D. of the release button.
Note 2) Value of FEP tubing.

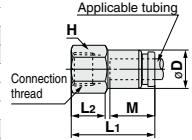

Plug: KQB2P

Applicable fitting size ϕd	Model	ϕD	L	A	Weight (g)
$\phi 1/8"$	KQB2P-01	5	28.9	16.9	2.8
$\phi 5/32"$	KQB2P-03	6	29.6	17	4.3
$\phi 1/4"$	KQB2P-07	8	30.3	16.8	9.4
$\phi 5/16"$	KQB2P-09	10	33.7	17.6	16.3
$\phi 3/8"$	KQB2P-11	11	34.1	17.5	22.2
$\phi 1/2"$	KQB2P-13	14	36.4	17.9	40.7

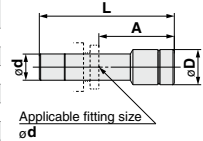

Metal One-touch Fittings

Applicable Tubing: Metric Size, Connection Thread: G*

* Conforming to ISO16030

KQB2 Series

RoHS



Applicable Tubing

Tubing material	FEP, PFA, Nylon, Soft nylon, Polyurethane, Polyolefin
Tubing O.D.	ø4, ø6, ø8, ø10, ø12, ø16

Specifications

Fluid	Air, Water ^{Note 2)}
Operating pressure range ^{Note 1)}	-100 kPa to 1 MPa ^{Note 3)}
Proof pressure	3.0 MPa
Ambient and fluid temperature ^{Note 4)}	-5 to 150°C (No freezing) ^{Note 3)}
Lubricant	Grease-free specification
Seal on the threads	O-ring seal

- Note 1) Avoid using in a vacuum holding application such as a leak tester, since there is leakage.
 Note 2) Deionized water is not recommended for use as it may affect the material used in the fittings. In addition, it is known to degrade the water quality.
 Note 3) Check the operating pressure range and operating temperature range of the tubing.
 Note 4) It is recommended that you use the inner sleeve in the following conditions:
- When using in an environment where the fluid temperature changes drastically.
 - When using at a high temperature.

* Temperature Condition of Mounting the Inner Sleeve

Tubing	Temperature
FEP tubing/TH Series	80°C or more
Super PFA tubing/TL Series	120°C or more

Spare Parts

Description	Tubing O.D.	Part no.	Material
Bulkhead nut	ø4	KQB223-P01	C3604 (Electroless nickel plated)
	ø6	KQB206-P01	
	ø8	KQB208-P01	
	ø10	KQB210-P01	
	ø12	KQB212-P01	
	ø16	KQB216-P01	

Description	Thread size	Part no.	Material
G thread O-ring	G1/8	KQB2-G01	Special FKM (Fluoro coated)
	G1/4	KQB2-G02	
	G3/8	KQB2-G03	
	G1/2	KQB2-G04	

Cross Reference Table of the Inner Sleeve

Tubing O.D.	Tubing material			Applicable inner sleeve	
	TUS (Soft polyurethane)	TH/THI (FEP)	TL/TIL (Super PFA)	Part no.	Length
ø4	—	TH0402	—	TJ-0402	18
	TUS0425	TH0425	—	TJ-0425	18
	—	—	TL0403	TJ-0403	18
ø6	TUS0604	TH0604	TL0604	TJ-0604	19
	TUS0805	—	—	TJ-0805	20.5
ø8	—	TH0806	TL0806	TJ-0806	20.5
	TUS1065	—	—	TJ-1065	23
ø10	—	TH1075	—	TJ-1075	23
	—	TH1008	TL1008	TJ-1008	23
	TUS1208	—	—	TJ-1008	24
ø12	—	TH1209	—	TJ-1209	24
	—	TH1210	TL1210	TJ-1210	24
	—	—	—	TJ-1210	24

* C2700 + Electroless nickel plated is used for the TJ series.

Construction

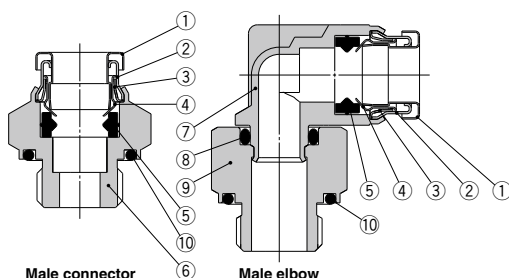

Component Parts

No.	Description	Material
1	Release button	Stainless steel 304
2	Guide 1	Stainless steel 304
3	Guide 2	Stainless steel 304
4	Chuck	Stainless steel 304
5	Seal	Special FKM (Fluoro coated)
6	Male connector body	C3604 (Electroless nickel plated)
7	Male elbow body	Stainless steel 316
8	O-ring	Special FKM (Fluoro coated)
9	Stud	C3604 (Electroless nickel plated)
10	G thread O-ring	Special FKM (Fluoro coated)

KQB2 Series

Applicable Tubing: Metric Size, Connection Thread: G

Dimensions

Male Connector: KQB2H



Applicable tubing O.D. (mm)	Connection thread G	Model	H (Width across flat)	øD	ød	L	A	M	Note 1) Effective area (mm ²)	Weight (g)
ø4	1/8	KQB2H04-G01	14	—	13.8	16.6	11.1	12.6	5.6	9.2
	1/4	KQB2H04-G02	19		17.8	20.6	14.1			23.6
ø6	1/8	KQB2H06-G01	14	—	13.8	17.6	12.1	13.6	13.1	8.9
	1/4	KQB2H06-G02	19		17.8	20.5	14			21.6
	3/8	KQB2H06-G03	22		21.8	23.4	15.9			38.3
ø8	1/8	KQB2H08-G01	14	—	13.8	23.9	18.4	16.1	26.1	13.2
	1/4	KQB2H08-G02	19		17.8	21.2	14.7			19.1
	3/8	KQB2H08-G03	22		21.8	24	16.5			35.2
ø10	1/8	KQB2H10-G01	17	—	13.8	25.1	19.6	17	41.5	26.1
	1/4	KQB2H10-G02	19		17.8	24.9	18.4			24.8
	3/8	KQB2H10-G03	22		21.8	23.3	15.8			30.9
	1/2	KQB2H10-G04	27		26.5	27.7	18.7			64.4
ø12	1/4	KQB2H12-G02	19	—	17.8	27.7	21.2	18.6	58.3	26.3
	3/8	KQB2H12-G03	22		21.8	23.5	16			25.5
	1/2	KQB2H12-G04	27		26.5	27.9	18.9			58
ø16	3/8	KQB2H16-G03	24	24.6	21.8	31.3	23.8	20.8	81	44.5
	1/2	KQB2H16-G04	27		26.5	27.3	18.3			113

Note) Value of FEP tubing.
Value of nylon tubing for ø16 only.

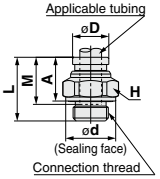

Hexagon Socket Head Male Connector: KQB2S



Applicable tubing O.D. (mm)	Connection thread G	Model	H (Width across flat)	Note 1) øD	ød	L	A	M	Note 2) Effective area (mm ²)	Weight (g)	
ø4	1/8	KQB2S04-G01	3	14	14	20.4	14.9	12.6	4.1	13.5	
	1/4	KQB2S06-G02	4	18	18	20.6	15.1			10	12.1
ø6	1/8	KQB2S06-G01	4	—	18	18	14.1	13.6	10.7	19.9	
	1/4	KQB2S06-G02	6		22	23.1	15.6			20.1	
	3/8	KQB2S08-G03	6		22	22	15.6			31.1	
ø8	1/8	KQB2S08-G01	5	—	18	18	22.9	16.1	17.2	12.5	
	1/4	KQB2S08-G02	6		22	23.1	15.6			20.1	
	3/8	KQB2S08-G03	6		22	22	15.6			31.1	
ø10	1/8	KQB2S10-G01	5	—	17	14	25.1	17	39	18.5	
	1/4	KQB2S10-G02	8		18	18	24.9			18.4	20.4
	3/8	KQB2S10-G03	8		22	22	16.5			31.2	
	1/2	KQB2S10-G04	8		27	26.5	15			45.3	
ø12	1/4	KQB2S12-G02	8	—	19	18	27.7	18.6	60	23.6	
	3/8	KQB2S12-G03	10		22	22	17.4			27.4	
	1/2	KQB2S12-G04	10		27	26.5	15.9			42.6	
ø16	3/8	KQB2S16-G03	10	24.6	22	31.3	23.8	20.8	81	41	
	1/2	KQB2S16-G04	12		27	26.5	18.8			113	42.9

Note 1) For the KQB2S16-G03, this dimension refers to the O.D. of the release button.
Note 2) Value of FEP tubing.
Value of nylon tubing for ø16 only.

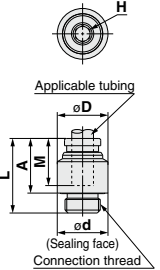

Dimensions

Male Elbow: KQB2L



Applicable tubing O.D. (mm)	Connection thread G	Model	H (With across flat)	Note 1) ϕD	ϕd	L ₁	L ₂	A	M	Note 2) Effective area (mm ²)	Weight (g)
$\phi 4$	1/8	KQB2L04-G01	14	9.1	13.8	14.4	18.9	17.9	12.6	4.2	15.6
	1/4	KQB2L04-G02	19		17.8	22.3	20.3	33			
$\phi 6$	1/8	KQB2L06-G01	14	11.4	13.8		20	20.2	13.6	11.4	17.2
	1/4	KQB2L06-G02	19		17.8	15.9	23.4	22.6			34.6
	3/8	KQB2L06-G03	22		21.8	25.9	24.1	54.5			
$\phi 8$	1/8	KQB2L08-G01	14	13.7	13.8	18.6	21.3	22.6	16.1	21.6	20.2
	1/4	KQB2L08-G02	19		17.8	19.1	24.7	25			36
	3/8	KQB2L08-G03	22		21.8	27.2	26.5	55.6			
$\phi 10$	1/8	KQB2L10-G01	14	16.6	13.8	20	22.7	25.5	17	35.2	25.7
	1/4	KQB2L10-G02	19		17.8		26.1	27.9			38.2
	3/8	KQB2L10-G03	22		21.8	21	28.6	29.4			56.2
	1/2	KQB2L10-G04	27		26.5	32.6	31.9	97.9			
$\phi 12$	1/4	KQB2L12-G02	19	18.7	17.8	22.6	27.2	30	18.6	50.2	41.9
	3/8	KQB2L12-G03	22		21.8	23.6	29.6	31.4			54.3
	1/2	KQB2L12-G04	27		26.5	33.6	33.9	94.6			
$\phi 16$	3/8	KQB2L16-G03	22	24.6	21.8	26.3	32.4	36.5	20.8	71	64.7
	1/2	KQB2L16-G04	27		26.5	27.3	36.4	39			100

Note 1) For the $\phi 16$, this dimension refers to the O.D. of the release button.

Note 2) Value of FEP tubing.

Value of nylon tubing for $\phi 16$ only.

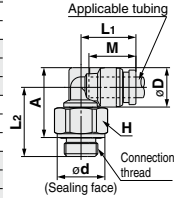

Male Branch Tee: KQB2T



Applicable tubing O.D. (mm)	Connection thread G	Model	H (With across flat)	Note 1) ϕD	ϕd	L ₁	L ₂	A	M	Note 2) Effective area (mm ²)	Weight (g)
$\phi 4$	1/8	KQB2T04-G01	14	9.1	13.8	14.4	18.9	17.9	12.6	6	17.5
	1/4	KQB2T04-G02	19		17.8	22.3	20.3	34.9			
$\phi 6$	1/8	KQB2T06-G01	14	11.4	13.8		20	20.2	13.6	13.9	21
	1/4	KQB2T06-G02	19		17.8	15.9	23.4	22.6			38
	3/8	KQB2T06-G03	22		21.8	25.9	24.1	57.9			
$\phi 8$	1/8	KQB2T08-G01	14	13.7	13.8	18.6	21.3	22.6	16.1	26.3	25.6
	1/4	KQB2T08-G02	19		17.8	19.1	24.7	25			41.2
	3/8	KQB2T08-G03	22		21.8	27.2	26.5	60.8			
$\phi 10$	1/8	KQB2T10-G01	14	16.6	13.8	20	22.7	25.5	17	40.8	34
	1/4	KQB2T10-G02	19		17.8		26.1	27.9			46
	3/8	KQB2T10-G03	22		21.8	21	28.6	29.4			64
	1/2	KQB2T10-G04	27		26.5	32.6	31.9	105.8			
$\phi 12$	1/4	KQB2T12-G02	19	18.7	17.8	22.6	27.2	30	18.6	57.2	53
	3/8	KQB2T12-G03	22		21.8	23.6	29.6	31.4			54.3
	1/2	KQB2T12-G04	27		26.5	33.6	33.9	105			
$\phi 16$	3/8	KQB2T16-G03	22	24.6	21.8	26.3	32.4	36.5	20.8	71	82.2
	1/2	KQB2T16-G04	27		26.5	27.3	36.4	39			100

Note 1) For the $\phi 16$, this dimension refers to the O.D. of the release button.

Note 2) Value of FEP tubing.

Value of nylon tubing for $\phi 16$ only.

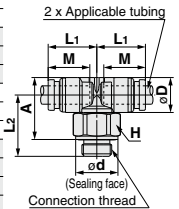

KQ2

KQB2

KS

KX

KM

KF

M

H/DL

L/LL

KC

KK

KK130

DM

KDM

KB

KR

KA

KQG2

KG

KFG2

MS

KKA

KP

LQ

MQR

T

IDK

KQB2 Series

Applicable Tubing: Metric Size, Connection Thread: G

Tubing One-touch fittings
Plug-in reducer/Plug

Tubing Tubing
Union elbow/Union tee/Straight union etc.

Refer to page 141 and after for details.

Dimensions

Bulkhead Connector: KQB2E



Applicable tubing O.D. (mm)	Connection thread G	Model	T (M)	Width across flat		L1	L2	Mounting hole	M	Note) Effective area (mm ²)	Weight (g)
				H1	H2						
ø4	1/8	KQB2E04-G01	M10 x 1	17	12	27.1	11	11	12.6	5.6	25.1
	1/4	KQB2E04-G02		19		32.7	16.6				36.9
	3/8	KQB2E06-G01		17		25.5	7.4				26.8
ø6	1/4	KQB2E06-G02	M14 x 1	19	17	33.5	15.4	15	13.6	13.1	42.7
	3/8	KQB2E06-G03		24		35	16.9				62
	1/2	KQB2E08-G01		17		27.6	8.2				30.4
ø8	1/4	KQB2E08-G02	M15 x 1	19	19	34.5	15.1	16	16.1	26.1	43.9
	3/8	KQB2E08-G03		24		36	16.6				66.2
	1/2	KQB2E10-G02		19		33.5	13.5				46.8
ø10	3/8	KQB2E10-G03	M18 x 1	24	21	35.6	15.6	19	17	41.5	65.4
	1/2	KQB2E12-G03		24		35.9	14.7				119.2
	3/8	KQB2E12-G04		27		42.2	21				91.9
ø12	1/2	KQB2E16-G03	M20 x 1	24	24	37.2	13.1	21	18.6	58.3	118.2
	3/8	KQB2E16-G04		29		43.1	19				96
	1/2	KQB2E16-G04		29		43.1	19				113

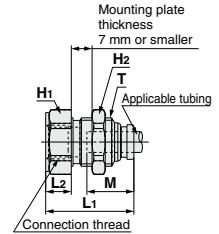

Note) Value of FEP tubing.
Value of nylon tubing for ø16 only.

Extended Male Union: KQB2W



Applicable tubing O.D. (mm)	Connection thread G	Model	H (Width across flat)	Note 1) øD	ød	L1	L2	A	M	Note 2) Effective area (mm ²)	Weight (g)
1/4	KQB2W04-G02	19	38.7	36.7	70.6						
1/8	KQB2W06-G01	14	36.4	36.6	36.1						
ø6	1/4	KQB2W06-G02	19	11.4	17.8	15.9	39.8	39	13.6	10.9	72.2
	3/8	KQB2W06-G03	22				42.3	40.5			106.7
	1/2	KQB2W08-G01	14				43.4	43.7			41.3
ø8	1/4	KQB2W08-G02	19	13.7	17.8	19.1	43.4	43.7	16.1	20.5	76.7
	3/8	KQB2W08-G03	22				45.9	45.2			112.9
	1/2	KQB2W10-G02	19				49.8	51.6			84.8
ø10	3/8	KQB2W10-G03	22	16.6	21.8	21	50.2	51	17	33.5	116.6
	1/2	KQB2W10-G04	27				54.2	53.5			196.6
	1/4	KQB2W12-G02	19				50.9	53.7			88.7
ø12	3/8	KQB2W12-G03	22	18.7	21.8	23.6	53.3	55.1	18.6	47.7	111.6
	1/2	KQB2W12-G04	27				57.3	57.6			193.8
	3/8	KQB2W16-G03	22				62	66.1			133.6
ø16	1/2	KQB2W16-G04	27	24.6	26.5	27.3	66	68.6	20.8	71	100
	3/8	KQB2W16-G03	22				66	68.6			201.6

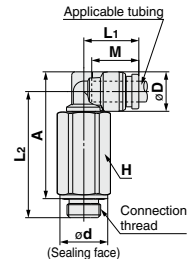

Note 1) For the ø16, this dimension refers to the O.D. of the release button.

Note 2) Value of FEP tubing.
Value of nylon tubing for ø16 only.

Female Connector: KQB2F



Applicable tubing O.D. (mm)	Connection thread G	Model	H (Width across flat)	Note 1) øD	L1	L2	M	Note 2) Effective area (mm ²)	Weight (g)		
										ø4	1/8
1/4	KQB2F04-G02	19	30.6	14.5	32						
1/8	KQB2F06-G01	17	25.5	9.7	22.6						
ø6	1/4	KQB2F06-G02	19	11.1	31.1	14.7	13.6	13.1	33		
	3/8	KQB2F06-G03	24						32.6	14.6	51.1
	1/2	KQB2F08-G01	17						27.6	10	25.1
ø8	1/4	KQB2F08-G02	19	13.4	33.2	14.9	16.1	26.1	36.3		
	3/8	KQB2F08-G03	24						34.6	14.7	53.8
	1/2	KQB2F10-G02	19						33.5	15.2	39.9
ø10	3/8	KQB2F10-G03	24	16.4	34.9	15	17	41.5	57.7		
	1/2	KQB2F12-G02	19						34.5	15.2	41.8
	3/8	KQB2F12-G03	24						35.9	15	59.7
ø12	1/2	KQB2F12-G04	27	18.5	41.8	19.9	18.6	58.3	81.6		
	3/8	KQB2F16-G03	24						37.2	15.4	66.6
	1/2	KQB2F16-G04	27						43.1	20.4	113

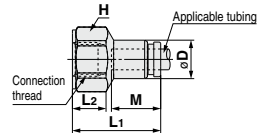

Note 1) For the ø10, ø12, and ø16, this dimension refers to the O.D. of the release button.

Note 2) Value of FEP tubing.
Value of nylon tubing for ø16 only.

Related Equipment

Spatter cover

(Applicable tubing: FR soft nylon, FR double layer, FR three-layer)



Applicable tubing O.D. (mm)	Model
ø6	KQB2-06C-X1124
ø8	KQB2-08C-X1124
ø10	KQB2-10C-X1124

* Since the spatter cover is designed for multi-layer (double layer, three-layer) tubing, sufficient effects cannot be obtained in foreign matter flow-in or followability for singlelayer tubing.

* The cover can be attached regardless of the single-layer/multi-layer tubing.

* Cannot be used for union "Y" (KQB2U) 2-port side.



KQB2 Series

Specific Product Precautions

Be sure to read this before handling the products.

Refer to back page 50 for Safety Instructions and pages 13 to 17 for Fittings and Tubing Precautions.

Selection

⚠ Caution

1. The surge pressure must be under the maximum operating pressure. If the surge pressure exceeds the maximum operating pressure, it will result in damage to fittings and tubing or the tubing may result in being fallen out.
2. If using a fluororesin tubing in an environment where the fluid temperature changes drastically, it is recommended to use an inner sleeve. Otherwise, air leakage may occur or the tube may release from fitting due to deformation of the tubing.
3. The particle generation of the KQB2 series depends on the operating conditions and operating environment. If you are concerned about the effects on machinery and equipment, check the particle generation with your machine before use.

The components of the KQB2 series may slide due to changes in the internal pressure, which may generate particles. When using male elbow, male branch tee, and extended male elbow fittings, particles may be generated by rotation for positioning after connecting.

Mounting

⚠ Caution

1. When performing the piping work, turn the tightening tool in the horizontal direction to the hex across flats of the stud so that any moment is not applied to the body.

If the tool is in contact with the body, this may cause the stud to come off.

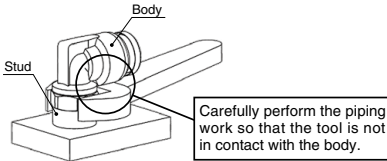

2. The union elbow, union tee, union "Y", different diameter tee and different diameter union "Y" should be fixed through the mounting hole.

Otherwise, air leakage or breaking can occur due to a pulling force or moment load created by the product's weight.

3. The elbow union, branch tee, and long elbow union can be turned for positioning after connecting, but they cannot be used while turning them.

Doing so may cause worn out metallic particles to enter the fluid or the fitting to break.

4. If the connection tube oscillates or turns, do not use this product.

Doing so may cause the fitting to break. In particular, for the product with the stud, this may cause the stud to come off.

Installation and Removal of Tubing

⚠ Caution

1. Installation of tubing

1) Grease is not used for the KQB2 series, therefore a greater insertion force is required when the tube is installed. In particular, polyurethane tubing may fold when inserted due to its softness. Hold the end of the tubing, and insert it all the way in slowly and securely. Refer to dimension "M" in the dimension drawings for guidance on the insertion depth of tubing.

2. Removal of tubing

1) For tubing used at a high temperature or for an extended period of time, there is a possibility that it will not fit into a One-touch fitting again due to an enlarged O.D. Dispose of the tubing and replace it with a new one.

Proper Tightening Torque of Fittings

⚠ Caution

1. Tighten fittings with sealant using the proper tightening torques in the table below. As a rule, they should be tightened 2 to 3 turns with a tool after first tightening by hand.

If tightened using a torque exceeding the proper torque level, this may cause the fitting to break.

In particular, for the product with the stud, the stud may come off.

R thread/NPT thread Proper tightening torque

Connection thread size	Proper tightening torque N·m
NPT, R1/8	3 to 5
NPT, R1/4	8 to 12
NPT, R3/8	15 to 20
NPT, R1/2	20 to 25

G thread Proper tightening torque

Connection thread size	Proper tightening torque N·m
G1/8	2.9 to 3.2
G1/4	5.7 to 6.3
G3/8	9.5 to 10.5
G1/2	14.3 to 15.8

KQ2

KQB2

KS

KX

KM

KF

M

H/DL

L/LL

KC

KK

KK130

DM

KDM

KB

KR

KA

KQG2

KG

KFG2

MS

KKA

KP

LQ

MQR

T

IDK