

Compact Direct Operated 2/3 Port Solenoid Valve for Water and Air

VDW Series

The production was discontinued. VDW200/300: 3 Port

The production of the VDW10/20/30 series was discontinued.
(Except for VDW10/20 manifold and 3 port type)
For details about new series: VDW10/20 → page 453
VDW30 → VX2 series



- VCH
- VDW
- SX10
- VQ
- LVM

Molded coil specifications have been added!

IP65



Grommet/Molded



Flat terminal/Molded

For Water and Air Compact Direct Operated 2/3 Port Solenoid Valve

VDW Series

The production of the VDW10/20/30 series was discontinued.
 (Except for VDW10/20 manifold and 3 port type)
 For details about new series: VDW10/20 → page 453
 VDW30 → VX2 series

Improved durability (Nearly twice the life of the previous series)

The use of a unique magnetic material reduces the operating resistance of moving parts, while improving service life, wear and corrosion resistance.

Improved corrosion resistance
 Special material introduced

High flow rate: Cv factor
 0.04 to 0.46 (2 port)

Universal porting
 VDW200/300 (3 port)

Improved environment resistance
 Environment resistance is improved by using a molded coil. (Enclosure IP65 or equivalent, grommet mold)



Grommet/Molded

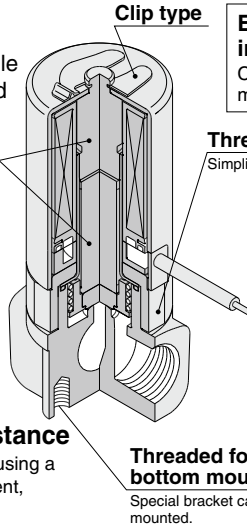

Ease of maintenance has been improved.

Changing of the coil is made easy by means of clip design. (2 port)

Threaded assembly
 Simplifies maintenance.

Brass (C37)/Stainless steel manifolds added to series (2 port)

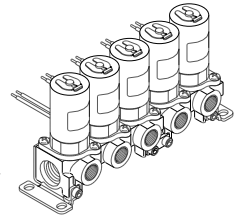

Lineup by Compact Design

2 Port			3 Port	
P.473			P.484	
ø17	ø20.5	ø28	ø20.5	ø28
<p>The production was discontinued.</p>				
VDW10	VDW20	VDW30	VDW200	VDW300

The production of the VDW10/20/30 series was discontinued.
 (Except for VDW10/20 manifold and 3 port type)
 For details about new series: VDW10/20 → page 453
 VDW30 → VX2 series

Compact Direct Operated 2 Port Solenoid Valve for Water and Air VDW10/20/30 Series



How to Order Valves (Single Unit)

VDW **2** **1** - **1** **G** - **2** - **01** □ - □ - □ - □ - □

For Water, Air, Vacuum

Series

1	10
2	20
3	30

Valve type

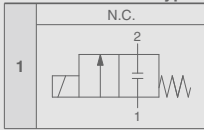

CE-compliant

Nil	—
Q	CE-compliant

Made to Order (Refer to page 474.)

Option

Nil	None
F	Foot bracket

Note) The foot bracket is packed with a valve.

Voltage

Symbol	Voltage	Grommet / Tape winding (G)	Flat terminal, Molded (F)	Grommet / Molded (W)
1	100 VAC (50/60 Hz)	●	—	●
2	200 VAC (50/60 Hz)	●	—	●
3	110 VAC (50/60 Hz)	●	—	●
4	220 VAC (50/60 Hz)	●	—	●
5	24 VDC	●	●	●
6	12 VDC	●	●	●
V	6 VDC	●	●	●
S	5 VDC	●	●	●
R	3 VDC	●	●	●

The production was discontinued.

Material and insulation type

Symbol	Body material	Seal material	Coil insulation
Nil		NBR	Class B
A	Brass (C37)	FKM	
B		EPDM	
G		NBR	
H	Stainless steel	FKM	
J		EPDM	
L (Note)		FKM	

Note) The armature assembly is a corrosion resistant construction.

Please consult with SMC regarding other voltages.

Coil type

G – Grommet / Tape winding W – Grommet / Molded

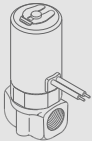

Magnet wire protection: Tape winding

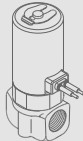

Magnet wire protection: Resin Molded

F – Flat terminal / Molded

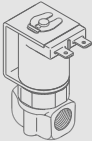

Magnet wire protection: Resin Molded

Thread type

Nil	Rc
F	G
N	NPT

Port size

Symbol	Port size	Series		
		10	20	30
M5	M5	○	○	—
01	1/8 (6A)	—	○	○
02	1/4 (8A)	—	—	○

Orifice diameter

Symbol	Orifice diameter (mm ø)	Series
1	1	10
2	1.6	
1	1.6	
2	2.3	20
3	3.2	
2	2	
3	3	30
4	4	

Series and Coil Type Combinations

Series	Grommet / Tape winding	Flat terminal / Molded	Grommet / Molded
10	●	—	●
20	●	●	●
30	●	●	●

VCH □
 VDW
 SX10
 VQ
 LVM

VDW10/20/30 Series

The production of the VDW10/20/30 series was discontinued.
 (Except for VDW10/20 manifold and 3 port type)
 For details about new series: VDW10/20 → page 453
 VDW30 → VX2 series

Standard Specifications



Valve specifications	Valve construction	Direct operated poppet	
	Fluid <small>Note 2)</small>	Water (except waste water or agricultural water), Air, Low vacuum	
	Withstand pressure (MPa)	2.0	
	Ambient temperature (°C)	-10 to 50	
	Fluid temperature (°C)	1 to 50 (No freezing)	
	Environment	Location without corrosive or explosive gases	
	Valve leakage (cm³/min)	0 (with water pressure) 1 or less (Air)	
Coil specifications	Mounting orientation	Unrestricted	
	Vibration/Impact (m/s²) <small>Note 4)</small>	30/150	
	Rated voltage	24 VDC, 12 VDC, 6 VDC, 5 VDC, 3 VDC, 100 VAC, 110 VAC, 200 VAC, 220 VAC (50/60 Hz)	
	Allowable voltage fluctuation (%)	±10% of rated voltage	
	Coil insulation type	Class B	
	Enclosure	Grommet / Tape winding	Dust-proof (equivalent to IP40)
		Flat terminal / Molded	Dust-tight (equivalent to IP60) <small>Note 5)</small>
Grommet / Molded		Dust-tight / Low jetproof (equivalent to IP65)	
Power consumption (W) <small>Note 3)</small>	2.5 (VDW10), 3 (VDW20/30)		

- Note 1) When used under conditions which may cause condensation on the exterior of the product, select Grommet / Molded.
- Note 2) When used with deionized water, select "L" (Stainless steel, FKM) for the material type.
- Note 3) Since the AC coil specification includes a rectifier element, there is no difference in power consumption between inrush and holding.
- In the case of 110/220 VAC, the VDW10 is 3 W and the VDW20/30 is 3.5 W.**
- Note 4) Vibration resistance No malfunction when tested with one sweep of 5 to 200 Hz in the axial direction and at a right angle to the armature, in both energized and deenergized states.
 Impact resistance No malfunction when tested with a drop tester in the axial direction and at a right angle to the armature, one time each in energized and deenergized states.
- Note 5) Since electrical connections are exposed, there is no water resistance.

Made to Order	Made to Order (For details, refer to page 489.)
Symbol	Specifications
The production was discontinued.	
-X23	Oil-free specification
-X60	Lead wire length: 600 mm specification
-X133	Seal material: Perfluoroelastomer specification

Characteristic Specifications

Model	Port size	Orifice dia. (mm ø)	Max. operating pressure differential (MPa) <small>Note 1)</small>		Operating Pressure range (MPa) <small>Note 2)</small>	Weight (kg)
			Pressure port 1			
VDW10	M5	1	0.9		0 to 1.0	0.08
		1.6	0.4			
VDW20	M5 1/8 (6A)	1.6	0.7			
		2.3	0.4			
		3.2	0.2			
VDW30	1/8 (6A) 1/4 (8A)	2	0.8			
		3	0.4			
		4	0.2			

- Note 1) The maximum operating pressure differential changes depending on the flow direction of the fluid. Refer to page 494 for details.
- Note 2) For low vacuum specifications, the operating pressure range is 1 Torr (1.33 x 10² Pa) to 1.0 MPa. Please consult with SMC if using below 1 Torr (1.33 x 10² Pa).

Flow Rate Characteristics

Model	Port size	Orifice dia. (mm ø)	Water			Air		
			1→2 (IN→N.C.)			1→2 (IN→N.C.)		
			N.C.	Kv	Cv converted	C [dm ³ /(s·bar)]	b	Cv
VDW10	M5	1	0.03	0.04	0.14	0.40	0.04	
		1.6	0.06	0.07	0.30	0.25	0.07	
VDW20	M5 1/8 (6A)	1.6	0.06	0.07	0.30	0.45	0.07	
		2.3	0.15	0.18	0.58	0.45	0.18	
		3.2	0.25	0.30	1.1	0.38	0.30	
VDW30	1/8 (6A) 1/4 (8A)	2	0.14	0.16	0.52	0.52	0.16	
		3	0.24	0.28	1.0	0.52	0.30	
		4	0.39	0.44	1.5	0.49	0.46	

Compact Direct Operated 2 Port Solenoid Valve for Water and Air **VDW10/20/30 Series**

The production of the VDW10/20/30 series was discontinued. (Except for VDW10/20 manifold and 3 port type)
For details about new series: VDW10/20 → page 453
VDW30 → VX2 series

Construction

VDW11

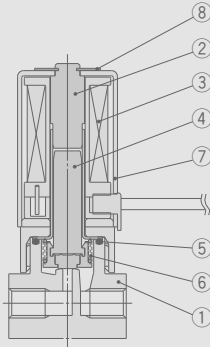

VDW21

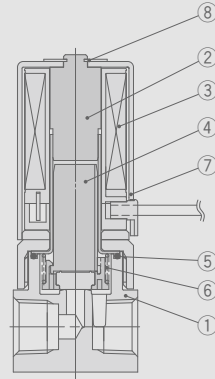

VDW31

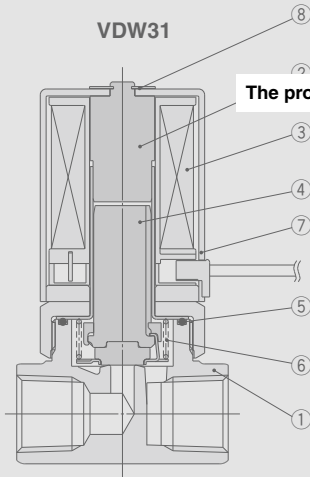

The production was discontinued.

Component Parts

No.	Description	Material	
		Standard	Option
1	Body	Brass (C37)	Stainless steel
2	Tube assembly	Stainless steel	—
3	Coil assembly	—	—
4	Armature assembly	Stainless steel, PPS, NBR	FKM, EPDM
5	O-ring (Body)	NBR	FKM, EPDM
6	Return spring	Stainless steel	—
7	Cover	SPCE	—
8	Clip	Stainless steel	—

VCH □

VDW

SX10

VQ

LVM

VDW10/20/30 Series

The production of the VDW10/20/30 series was discontinued. (Except for VDW10/20 manifold and 3 port type)
 For details about new series: VDW10/20 → page 453
 VDW30 → VX2 series

Dimensions

VDW11-□^G/_W

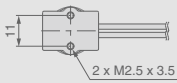
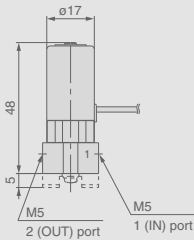
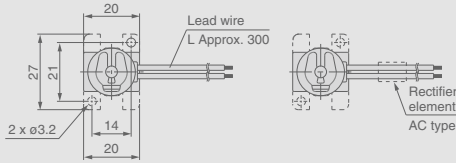

VDW21-□^G/_W

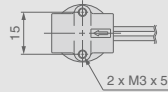
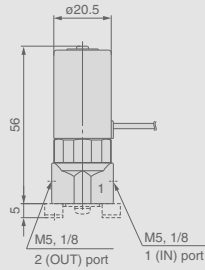
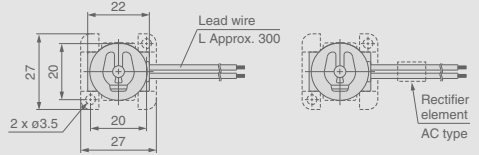

The production was discontinued.

VDW31-□^G/_W

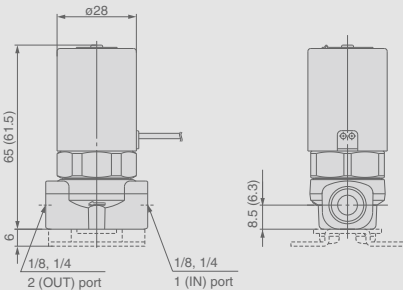
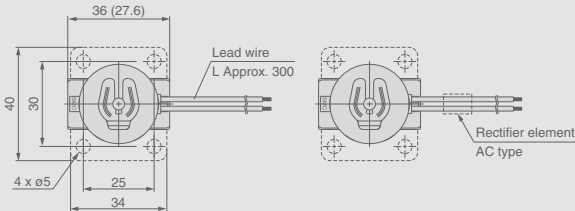

Dimensions inside () are for port size 1/8.

Bracket assembly part no.

- 10, 20 series

VDW **2** 0-15A-1

Series

1	10
2	20

- 30 series

VCW20-12-01A

Compact Direct Operated 2 Port Solenoid Valve for Water and Air **VDW10/20/30 Series**

The production of the VDW10/20/30 series was discontinued. (Except for VDW10/20 manifold and 3 port type)
For details about new series: VDW10/20 → page 453
VDW30 → VX2 series

Dimensions

VDW21-□F

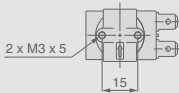
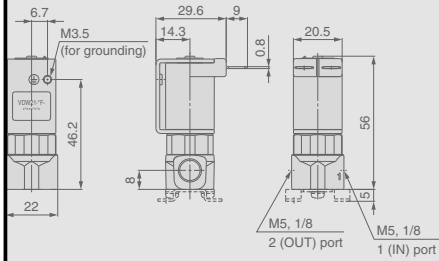
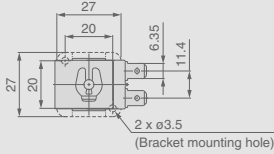

VDW31-□F

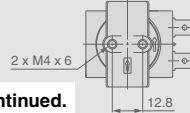
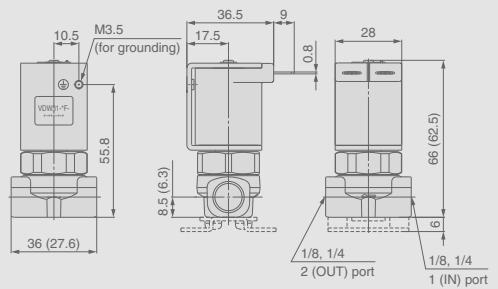
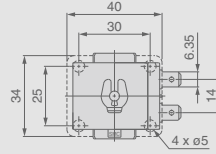

The production was discontinued.

Bracket assembly part no.

- 20 series

VDW20 – 15A – 1

- 30 series

V CW20 – 12 – 01A

VCH □

VDW

SX10

VQ

LVM

VDW10/20/30 Series



How to Order Manifold

VV2DW **2** - **05** **01** - - -

Series

1	10
2	20
3	30

Material

Symbol	Manifold material	Seal material
NII	Brass (C37)	NBR
A		FKM
B		EPDM
G	Stainless steel	NBR
H		FKM
J		EPDM

Stations

02	2 stations
:	:
10	10 stations

CE-compliant

NII	—
Q	CE-compliant

Option

NII	None
F	With bracket

Note) 30 series is available with bracket only.

Thread type

NII	Rc
F	G*
N	NPT

* For connection, prepare a fitting compliant with ISO 16030 and JIS B 8674.

OUT port size

Symbol	Port size	Series		
		10	20	30
M5	M5	○	○	—
01	1/8 (6A)	—	○	○
02	1/4 (8A)	—	—	○

Note) IN port sizes are as follows.
 10: 1/8 (6A)
 20: 1/4 (8A)
 30: 3/8 (10A)

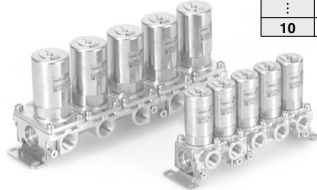

How to Order Manifold Assembly

Enter the mounting valve and option part numbers under the manifold base part number.

<Ordering example>
 VV2DW2-0501 (-Q) 1 set Manifold part no.
 *VDW23-5G-2 (-Q) 5 sets Valve part no.
 (Stations 1 to 5)

*"s" is the symbol for assembly. Add an "s" in front of the part numbers to have solenoid valves, etc. mounted on manifold.

Enter together in order, counting from station 1 on the D side.

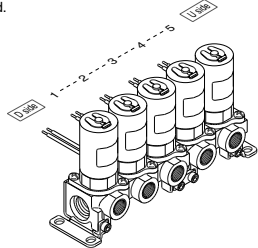

How to Order Valves (For Manifold)

VDW **2** **3** - **5** **G** - **2** - - -

Series

1	10
2	20
3	30

Valve type

3	N.C. for manifold
---	-------------------

Voltage

Symbol	Voltage	Grommet / Tape winding (G)	Flat terminal, Molded (F)	Grommet / Molded (W)
1	100 VAC (50/60 Hz)	●	—	●
2	200 VAC (50/60 Hz)	●	—	●
3	110 VAC (50/60 Hz)	●	—	●
4	220 VAC (50/60 Hz)	●	—	●
5	24 VDC	●	●	●
6	12 VDC	●	●	●
V	6 VDC	●	●	●
S	5 VDC	●	●	●
R	3 VDC	●	●	●

* Please consult with SMC regarding other voltages.

CE-compliant

NII	—
Q	CE-compliant

Material and insulation type

Symbol	Body material	Seal material	Coil insulation
NII	Brass (C37)	NBR	Class B
A		FKM	
B		EPDM	
G	Stainless steel	NBR	
H		FKM	
J		EPDM	
L (Note)		FKM	

Note) The armature assembly is a corrosion resistant construction.

Orifice diameter

Symbol	Orifice diameter (mmø)	Series
1	1	10
2	1.6	
1	1.6	20
2	2.3	
3	3.2	
2	2	
3	3	30
4	4	

Coil type (Note)

G	Grommet / Tape winding
F	Flat terminal / Molded
W	Grommet / Molded

Note) About series and coil type combinations, refer to page 473.

Manifold Options

Blanking plate assembly

• 10, 20 series

VVDW **2** **0** - **3A** - -

Series

1	10
2	20

Material

Symbol	Plate material	Seal material
G	Stainless steel	NBR
H		FKM
J		EPDM

* Plate material is stainless steel only.

• 30 series

VVCW20 - 3A - -

The production was discontinued.

Symbol	Plate material	Seal material
G	Stainless steel	NBR
H		FKM
J		EPDM

Compact Direct Operated 2 Port Solenoid Valve for Water and Air **VDW10/20/30 Series**

Dimensions

VV2DW1

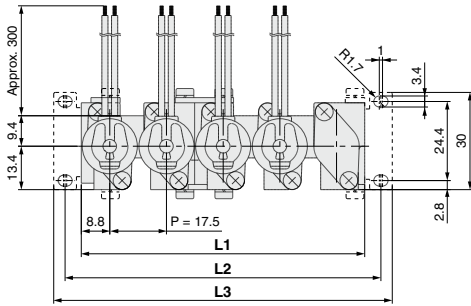
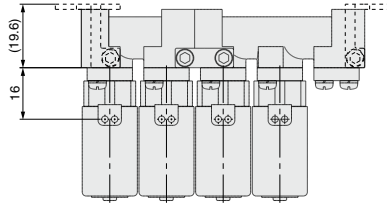
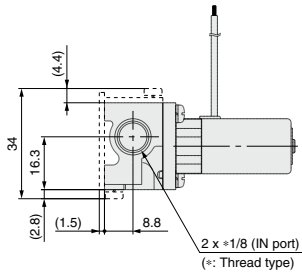

D side

Stations 1 2 3 4 5 n

U side

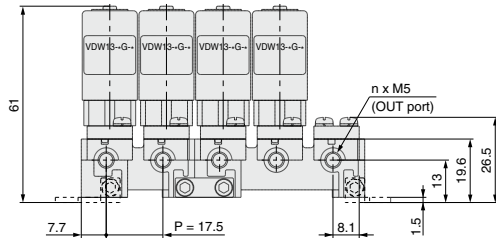

4 x M3 x 0.5
* When w/o bracket, M3 threads at both ends (4 locations) can be used for other purposes.

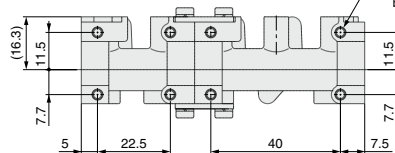

L Dimension

Dimension	n (stations)									
	2	3	4	5	6	7	8	9	10	
L1	35	52.5	70	87.5	105	122.5	140	157.5	175	
L2	45	62.5	80	97.5	115	132.5	150	167.5	185	
L3	52	69.5	87	104.5	122	139.5	157	174.5	192	
Manifold composition	2 stns. x 1	3 stns. x 1	2 stns. x 2	2 stns. + 3 stns.	3 stns. x 2	2 stns. x 2 + 3 stns.	2 stns. + 3 stns. x 2	3 stns. x 3	2 stns. x 2 + 3 stns. x 2	

Note) Manifold base is consisted of the junction of 2 and 3 station bases.

Refer to pages 482 and 483 regarding manifold additions.

VDW10/20/30 Series

Dimensions

VV2DW2

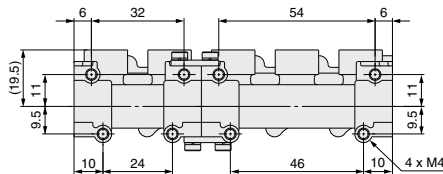
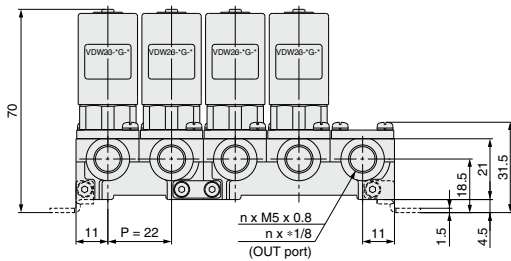
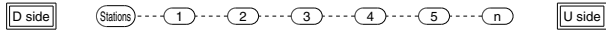
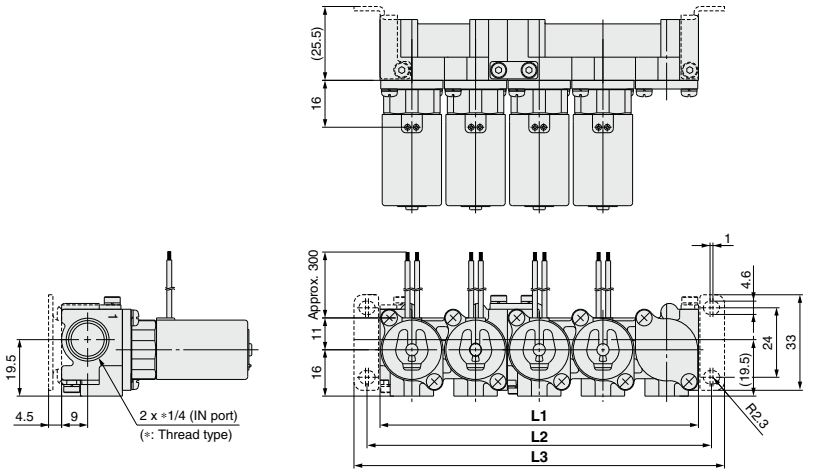

* When w/o bracket, M4 threads at both ends (4 locations) can be used for other purposes.

L Dimension

Dimension	n (stations)									
	2	3	4	5	6	7	8	9	10	
L1	44	66	88	110	132	154	176	198	220	
L2	53	75	97	119	141	163	185	207	229	
L3	62	84	106	128	150	172	194	216	238	
Manifold composition	2 stns. x 1	3 stns. x 1	2 stns. x 2	2 stns. + 3 stns.	3 stns. x 2	2 stns. x 2 + 3 stns.	2 stns. + 3 stns. x 2	3 stns. x 3	2 stns. x 2 + 3 stns. x 2	

Note) Manifold base is consisted of the junction of 2 and 3 station bases.
Refer to pages 482 and 483 regarding manifold additions.

Compact Direct Operated 2 Port Solenoid Valve for Water and Air **VDW10/20/30 Series**

VV2DW3

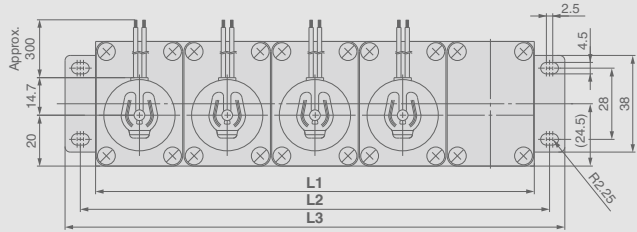
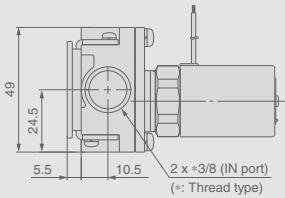
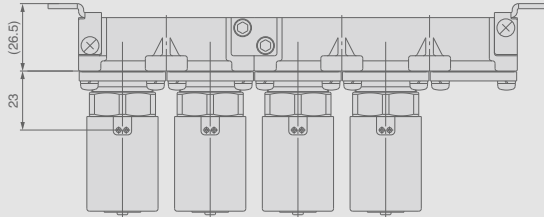

D side
The production was discontinued.
----- 4 ----- 5 ----- n -----
U side

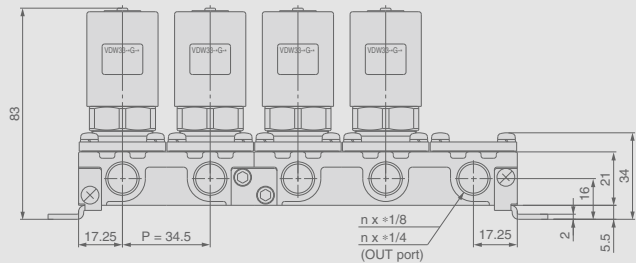

- VCH
- VDW
- SX10
- VQ
- LVM

L Dimension

Dimension	n (stations)									
	2	3	4	5	6	7	8	9	10	
L1	70	105	140	175	210	245	280	315	350	
L2	82	117	152	187	222	257	292	327	362	
L3	94	129	164	199	234	269	304	339	374	

Manifold composition 2 stns. x 1 3 stns. x 1 2 stns. x 2 2 stns. + 3 stns. 3 stns. x 2 2 stns. x 2 + 3 stns. 2 stns. + 3 stns. x 2 3 stns. x 3 2 stns. x 2 + 3 stns. x 2

Note) Manifold base is consisted of the junction of 2 and 3 station bases.
Refer to pages 482 and 483 regarding manifold additions.

VDW10/20/30 Series

Manifold Exploded View

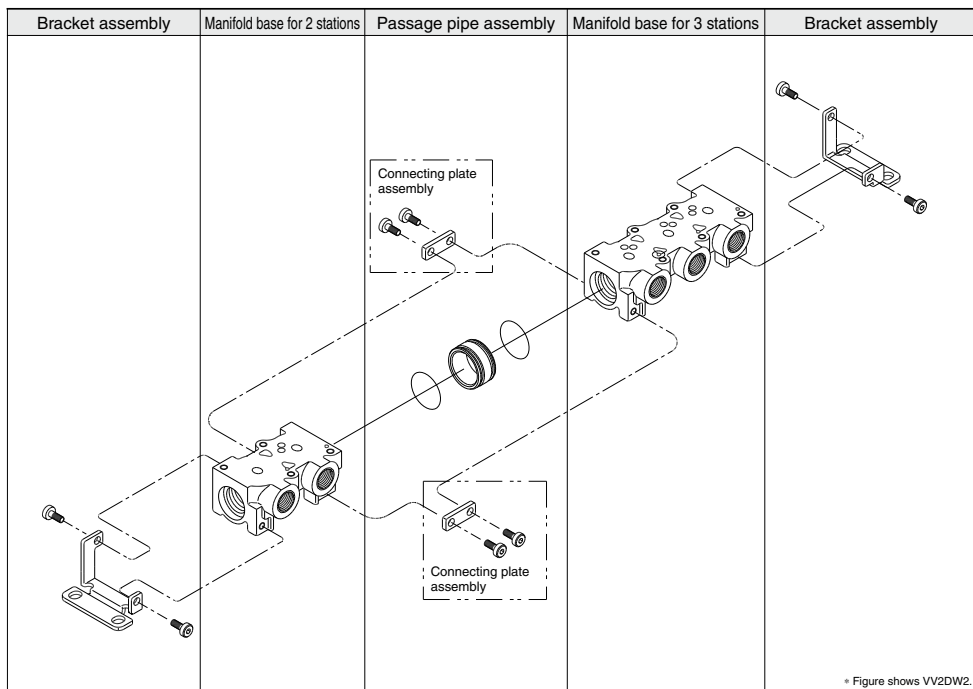

Manifold additions

- 1 Install a passage pipe assembly in between the manifold bases to be added.
- 2 Connect the respective manifold bases with a connecting plate assembly. (Tightening torque: 0.9 ± 0.1 N·m)
- 3 Attach brackets to the manifold bases. (when equipped with brackets) (Tightening torque: 0.9 ± 0.1 N·m)

Note) Manifold can be increased by every 2 or 3-station unit.

Order one set each of manifold base, connection plate assembly and passage pipe assembly.

Compact Direct Operated 2 Port Solenoid Valve for Water and Air **VDW10/20/30 Series**

<Manifold base>

- 10, 20 series

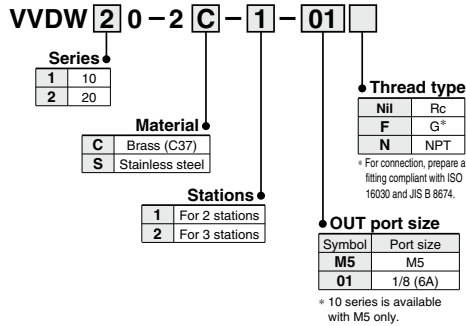

<Connecting plate assembly>

- 10, 20 series

VVDW **2** 0 - 4A

Note) Two sets of connecting plate and mounting screws.

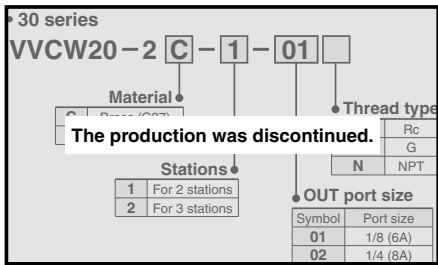
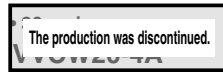
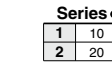

<Passage pipe assembly>

- 10, 20 series

VVDW **2** 0 - 6A -



Material

Symbol	Pipe material	Seal material
Nil		NBR
A	Brass (C37)	FKM
B		EPDM
G		NBR
H	Stainless steel	FKM
J		EPDM

<Bracket assembly>

- 10, 20 series

VVDW **2** 0 - 5A



Note) Consists of a set for D and U sides.

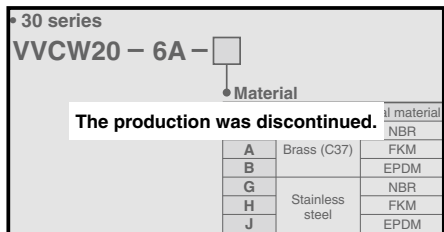
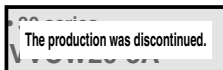

VCH

VDW

SX10

VQ

LVM

Compact Direct Operated 3 Port Solenoid Valve for Water and Air VDW200/300 Series



How to Order Valves (Single Unit)

VDW **2** 50 - **1** **G** - **2** - **01** - - - - -

For Water, Air, Vacuum

Series

2	200
3	300

Valve type

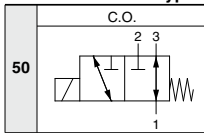

CE-compliant

Nil	—
Q	CE-compliant

Made to Order
(Refer to page 485.)

Option

Nil	None
F	Foot bracket

Note) The foot bracket is packed with a valve.

Voltage

Symbol	Voltage	Grommet / Tape winding (G)	Flat terminal / Molded (F)	Grommet / Molded (W)
1	100 VAC (50/60 Hz)	●	—	●
2	200 VAC (50/60 Hz)	●	—	●
3	110 VAC (50/60 Hz)	●	—	●
4	220 VAC (50/60 Hz)	●	—	●
5	24 VDC	●	●	●
6	12 VDC	●	●	●
V	6 VDC	●	●	●
S	5 VDC	●	●	●
R	3 VDC	●	●	●

* Please consult with SMC regarding other voltages.

Material and insulation type

Symbol	Body material	Seal material	Coil insulation
Nil	Brass (C37)	NBR	Class B
A		FKM	
B		EPDM	
G	NBR		
H	Stainless steel	FKM	
J	Stainless steel	EPDM	
L ^{Note)}		FKM	

Note) The armature assembly is a corrosion resistant construction.

Thread type

Nil	Rc
F	G*
N	NPT

* For connection, prepare a fitting compliant with ISO 16030 and JIS B 8674.

Coil type

G – Grommet / Tape winding	W – Grommet / Molded
<p>Magnet wire protection: Tape winding</p>	<p>Magnet wire protection: Resin Molded</p>
<p>F – Flat terminal / Molded</p> <p>Magnet wire protection: Resin Molded</p>	

Port size

Symbol	Port size	Series	
		200	300
M5	M5	○	—
01	1/8 (6A)	○	○
02	1/4 (8A)	—	○

Orifice diameter

Symbol	N.C. Orifice diameter (mm ø)	N.O. Orifice diameter (mm ø)	Series
1	1	1	200
2	1.6		
2	2	1.8	300
3	3		
4	4		

Compact Direct Operated 3 Port Solenoid Valve for Water and Air **VDW200/300 Series**

Standard Specifications



Valve specifications	Valve construction		Direct operated poppet
	Fluid ^{Note 2)}		Water (except waste water or agricultural water), Air, Low vacuum
	Withstand pressure (MPa)		2.0
	Ambient temperature (°C)		-10 to 50
	Fluid temperature (°C)		1 to 50 (No freezing)
	Environment		Location without corrosive or explosive gases
	Valve leakage (cm³/min)		0 (with water pressure) 1 (Air)
Coil specifications	Mounting orientation		Unrestricted
	Vibration/Impact (m/s²) ^{Note 4)}		30/150
	Rated voltage		24 VDC, 12 VDC, 100 VAC, 110 VAC, 200 VAC, 220 VAC (50/60 Hz)
	Allowable voltage fluctuation (%)		±10% of rated voltage
	Coil insulation type		Class B
	Enclosure ^{Note 6)}	Grommet / Tape winding	Dust-proof (equivalent to IP40)
Flat terminal / Molded		Dust-tight (equivalent to IP60) ^{Note 5)}	
		Grommet / Molded	Dust-tight / Low jetproof (equivalent to IP65)
Power consumption (W) ^{Note 3)}		3	

Note 1) Please consult with SMC when used under conditions which may cause condensation on the exterior of the product.

Note 2) When used with deionized water, select "L" (Stainless steel, FKM) for the material type.

Note 3) Since the AC coil specification includes a rectifier element, there is no difference in power consumption between inrush and holding.

3.5 W in the case of 110/220 VAC

Note 4) Vibration resistance No malfunction when tested with one sweep of 5 to 200 Hz in the axial direction and at a right angle to the armature, in both energized and deenergized states.

Impact resistance No malfunction when tested with a drop tester in the axial direction and at a right angle to the armature, one time each in energized and deenergized states.

Note 5) Since electrical connections are exposed, there is no water resistance.

Note 6) For enclosure, refer to "Glossary of Terms" on page 495. When using the product in a place which requires water resistance, please contact SMC.

Made to Order

Made to Order
(For details, refer to page 489.)

Symbol	Specifications
-X22	Non-leak (10 ⁻⁶ Pa·m ³ /sec) / Vacuum (0.1Pa-abs) specification
-X23	Oil-free specification
-X60	Lead wire length: 600 mm specification
-X133	Seal material: Perfluoroelastomer specification

Characteristic Specifications

Model	Port size	Orifice dia. (mm ø)	Max. operating pressure differential (MPa) ^{Note 2)}		Operating pressure range (MPa) ^{Note 3)}	Weight (kg)
			Pressure port 1	Pressure port 2, 3 ^{Note 1)}		
VDW200	M5 1/8 (6A)	1	0.9	0.3	0 to 1.0	0.12
		1.6	0.7	0.1		
VDW300	1/8 (6A) 1/4 (8A)	2	0.8	0.2		
		3	0.4	0.1		
		4	0.2	0.05		

Note 1) Indicates the maximum operating pressure differential of pressure ports 2 and 3.

Note 2) The maximum operating pressure differential changes depending on the flow direction of the fluid. Refer to page 494 for details.

Note 3) For low vacuum specifications, the operating pressure range is 1 Torr (1.33 x 10² Pa) to 1.0 MPa. Please consult with SMC if using below 1 Torr (1.33 x 10² Pa).

Flow Rate Characteristics

Model	Port size	Orifice dia. (mm ø)		Water				Air					
				1→2 (IN→N.C.)		1→3 (IN→N.O.)		1→2 (IN→N.C.)			1→3 (IN→N.O.)		
		N.C.	N.O.	Kv	Cv converted	Kv	Cv converted	C [dm ³ /(s·bar)]	b	Cv	C [dm ³ /(s·bar)]	b	Cv
VDW200	M5 1/8 (6A)	1	1	0.03	0.03	0.03	0.04	0.12	0.35	0.03	0.13	0.52	0.04
		1.6		0.06	0.07			0.30	0.45	0.07			
VDW300	1/8 (6A) 1/4 (8A)	2	1.8	0.14	0.16	0.11	0.13	0.52	0.52	0.16	0.38	0.50	0.12
		3		0.24	0.28			1.0	0.52	0.30			
		4		0.39	0.44			1.5	0.49	0.46			

VDW200/300 Series

Construction

VDW250

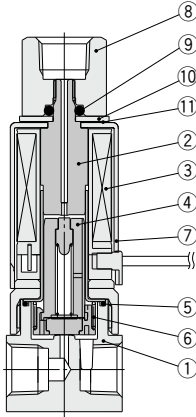

VDW350

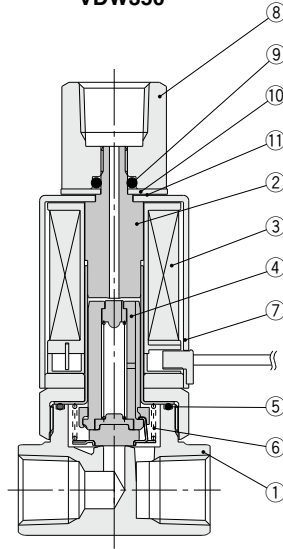

Component Parts

No.	Description	Material	
		Standard	Option
1	Body	Brass (C37)	Stainless steel
2	Tube assembly	Stainless steel	—
3	Coil assembly	—	—
4	Armature assembly	Stainless steel, PPS, NBR	Stainless steel, PPS, FKM, EPDM
5	O-ring (Body)	NBR	FKM, EPDM
6	Return spring	Stainless steel	—
7	Cover	SPCE	—
8	Socket	C36	Stainless steel
9	O-ring	NBR	FKM, EPDM
10	Plate	SPCC	—
11	Wave washer	Stainless steel	—

Compact Direct Operated
3 Port Solenoid Valve for Water and Air **VDW200/300 Series**

Dimensions

VDW250-□^G_W

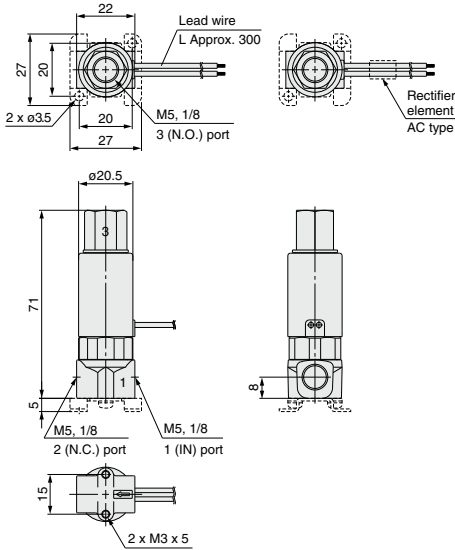

VDW350-□^G_W

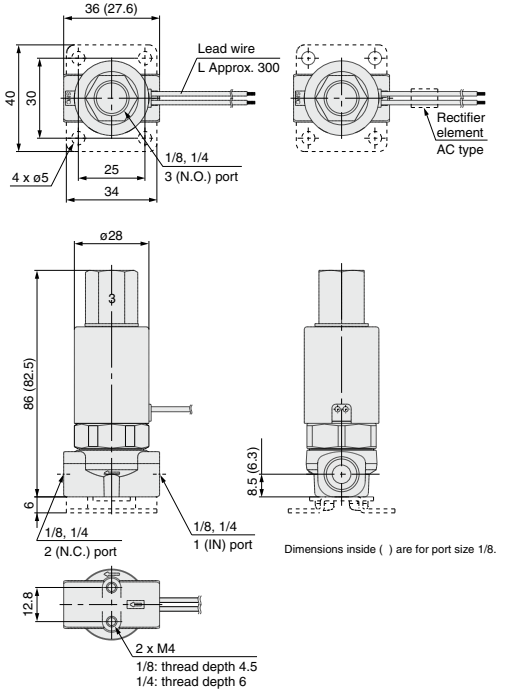

Bracket assembly part no.

- 200 series

VDW20-15A-1

- 300 series

VCW20-12-01A

VCH□

VDW

SX10

VQ

LVM

VDW200/300 Series

Dimensions

VDW250-□F

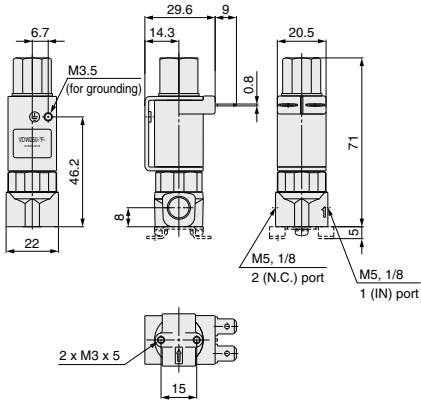
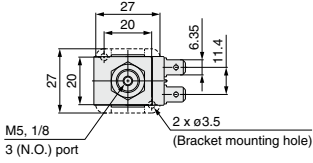

VDW350-□F

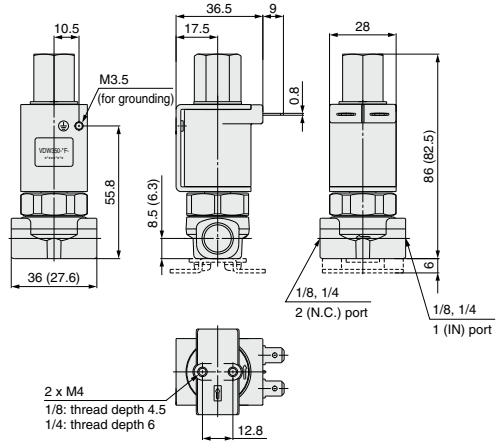
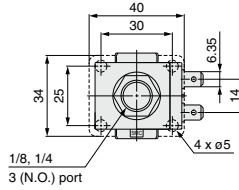

Bracket assembly part no.

- 200 series

VDW20-15A-1

- 300 series

V CW20-12-01A

VDW Series

Made to Order Specifications:

Please consult with SMC for detailed size, specifications and delivery.

The production of the VDW10/20/30 series was discontinued.
(Except for VDW10/20 manifold and 3 port type)
For details about new series:
VDW10/20 → page 453
VDW30 → VX2 series



1 Non-leak (10^{-6} Pa·m³/sec)/Vacuum (0.1 Pa-abs) Specification

Symbol **-X22**

VDW — X22(-Q)

2 Oil-free Specification

Symbol **-X23**

VDW — X23(-Q)

3 Lead Wire Length: 600 mm Specification

Symbol **-X60**

VDW — X60(-Q)

4 Seal Material: Perfluoroelastomer Specification

Symbol **-X133**

VDW — X133(-Q)

Note) Select from A, H, or L for the material and insulation type.

VCH

VDW

SX10

VQ

LVM

Glossary of Terms

The production of the VDW10/20/30 series was discontinued.
 (Except for VDW10/20 manifold and 3 port type)
 For details about new series: VDW10/20 → page 453
 VDW30 → VX2 series

Pressure Terminology

1. Maximum operating pressure differential

This indicates the maximum pressure differential (inlet and outlet pressure differential) which can be allowed for operation with the valve closed or open. When the outlet pressure is 0 MPa, this becomes the maximum operating pressure.

2. Maximum operating pressure

This indicates the limit of pressure that can be applied inside the pipelines. (Line pressure)
 (The pressure differential of the solenoid valve unit must be no more than the maximum operating pressure differential.)

3. Withstand pressure

The pressure which must be withstood without a drop in performance after returning to the operating pressure range (The value under the prescribed conditions).

Electrical Terminology

1. Surge voltage

A high voltage which is momentarily generated in the shut-off unit by shutting off the power.

2. Enclosure

A degree of protection defined in the "JIS C 0920: Waterproof test of electric machinery/appliance and the degree of protection against the intrusion of solid foreign objects".

Verify the degree of protection for each product.

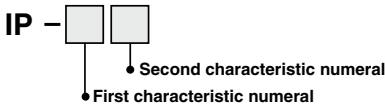

● First Characteristics: Degrees of protection against solid foreign objects

0	Non-protected
1	Protected against solid foreign objects of 50 mm ϕ and greater
2	Protected against solid foreign objects of 12 mm ϕ and greater
3	Protected against solid foreign objects of 2.5 mm ϕ and greater
4	Protected against solid foreign objects of 1.0 mm ϕ and greater
5	Dust-protected
6	Dusttight

● Second Characteristics: Degrees of protection against water

0	Non-protected	—
1	Protected against vertically falling water drops	Dripproof type 1
2	Protected against vertically falling water drops when enclosure tilted up to 15°	Dripproof type 2
3	Protected against rainfall when enclosure tilted up to 60°	Rainproof type
4	Protected against splashing water	Splashproof type
5	Protected against water jets	Low jetproof type
6	Protected against powerful water jets	Strong jetproof type
7	Protected against the effects of temporary immersion in water	Immersible type
8	Protected against the effects of continuous immersion in water	Submersible type

Example) IP65: Dusttight, Low jetproof type
 "Low jetproof type" means that no water intrudes inside an equipment that could hinder from operating normally by means of applying water for 3 minutes in the prescribed manner. Take appropriate protection measures, since a device is not usable in an environment where a droplet of water is splashed constantly.

Other

1. Material

NBR: Nitrile rubber
 FKM: Fluororubber
 EPDM: Ethylene propylene rubber
 C37: Brass
 SUS: Stainless steel

Flat Terminal

1. Flat terminal/Electrical connection size of molded coil

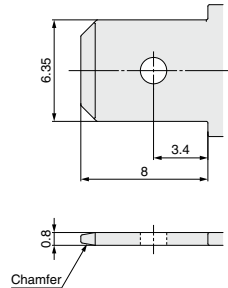

2. When providing a body ground, please use the frame ground (M3.5).

(Recommended fastening bolt: M3.5, length 5 mm)



VDW Series

Specific Product Precautions 1

Be sure to read this before handling the products.

Refer to back page 50 for Safety Instructions and pages 17 to 19 for 2 Port Solenoid Valve for Fluid Control Precautions.

The production of the VDW10/20/30 series was discontinued.
(Except for VDW10/20 manifold and 3 port type)
For details about new series: VDW10/20 → page 453
VDW30 → VX2 series

Design

Warning

1. Cannot be used as an emergency shutoff valve, etc.

The valves presented in this catalog are not designed for safety applications such as an emergency shutoff valve. If the valves are used in this type of system, other reliable safety assurance measures should also be adopted.

2. Extended periods of continuous energization

Please consult with SMC when using with energization for long periods of time.

3. Closed liquid circuit

In a closed circuit, when liquid is static, pressure could rise due to changes in temperature. This pressure rise could cause malfunction and damage to components such as valves. To prevent this, install a relief valve in the system.

4. This solenoid valve cannot be used for explosion proof applications.

5. Maintenance space

The installation should allow sufficient space for maintenance activities (removal of valve, etc.).

Selection

Warning

1. Confirm the specifications.

Give careful consideration to the operating conditions such as the application, fluid and environment, and use within the operating ranges specified in this catalog.

2. Fluid temperature

Please use within the operating fluid temperature range.

3. Fluid quality

In the case of water

The use of a fluid which contains foreign matter can cause problems such as malfunction and seal failure by promoting wear of the valve seat and armature, and by sticking to the sliding parts of the armature, etc. Install a suitable filter (strainer) immediately upstream from the valve. In general, a mesh of about 80 to 100 is a guideline for the filter.

In the case of air

Please use ordinary compressed air where a filter of 40 μm or less is provided on the inlet side piping. (Except dry air)

Selection

Caution

1. Leakage voltage

When the solenoid valve is operated using the controller, etc., the leakage voltage should be the product allowable leakage voltage or less.

Particularly when using a resistor in parallel with a switching element and using a C-R element (surge voltage suppressor) to protect the switching element, take note that leakage current will flow through the resistor, C-R element, etc., creating a possible danger that the valve may not turn off.

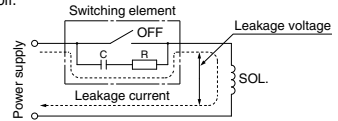

AC coil

10% or less of rated voltage

DC coil

2% or less of rated voltage

2. Low temperature operation

1) The valves can be used up to an ambient temperature of -10°C , however take measures to prevent solidification of impurities or freezing etc.

2) When using valves for water application in cold climates, first stop the water supply/discharge of the pump etc., and then take measures to prevent freezing such as draining water in pipe. When heating by steam, be careful not to expose the coil portion to steam. Also, please take measures to prevent freezing such as heating the body.

Mounting

Warning

1. If air leakage increases or equipment does not operate properly, stop operation.

After mounting is completed, confirm that it has been done correctly by performing a suitable function test.

2. Do not apply external force to the coil section.

When tightening is performed, apply a wrench or other tool to the outside of the piping connection parts.

3. Do not warm the coil assembly with a heat insulator, etc.

Use tape, heaters, etc., for freeze prevention on the piping and body only. They can cause the coil to burn out.

4. Secure with brackets, except in the case of steel piping and copper fittings.

5. Avoid sources of vibration, or adjust the arm from the body to the minimum length so that resonance will not occur.

6. Operation manual

The product should be mounted and operated after the Operation Manual is thoroughly read and its contents are understood. Keep the Operation Manual where it can be referred to as needed.

7. Painting and coating

Warnings or specifications printed or labeled on the product should not be erased, removed or covered up.

VCH □

VDW

SX10

VQ

LVM



VDW Series

Specific Product Precautions 2

Be sure to read this before handling the products.

Refer to back page 50 for Safety Instructions and pages 17 to 19 for 2 Port Solenoid Valve for Fluid Control Precautions.

The production of the VDW10/20/30 series was discontinued.
(Except for VDW10/20 manifold and 3 port type)
For details about new series: VDW10/20 → page 453
VDW30 → VX2 series

Piping

⚠ Caution

1. Preparation before piping

Before piping is connected, it should be thoroughly blown out with air (flushing) or washed to remove chips, cutting oil and other debris from inside the pipe.

2. Winding of sealant tape

When connecting pipes, fittings, etc., be sure that chips from the pipe threads and sealing material do not enter the valve. Furthermore, when sealant tape is used, leave 1.5 to 2 thread ridges exposed at the end of the threads.

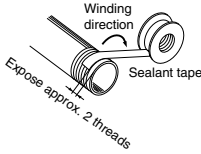

3. Avoid connecting ground lines to piping, as this may cause electric corrosion of the system.

4. Connection of piping and fittings

When screwing piping or fittings into the valve, tighten them as follows.

○ When using SMC's fittings, follow the procedures below to tighten them.

• Connection thread: M5

First, tighten by hand, then use a suitable wrench to tighten the hexagonal portion of the body an additional 1/6 to 1/4 turn.

The reference value for the tightening torque is 1 to 1.5 N·m.

• Fittings with sealant: R, NPT

First, tighten the fitting by hand, then use a suitable wrench to tighten the hexagonal portion of the body a further two or three turns.

For the tightening torque, refer to the table below.

Connection thread size (R, NPT)	Proper tightening torque (N·m)
1/8	3 to 5
1/4	8 to 12
3/8	15 to 20

○ When using a fitting other than an SMC fitting, follow the instructions given by the fitting manufacturer.

5. Connection of piping to products

- When connecting piping to a product, refer to its operation manual to avoid mistakes regarding the supply port, etc.
- Do not apply external force to the coil when holding it to connect piping, as the tube may deform.

Wiring

⚠ Caution

1. As a rule, use electrical wire with a cross sectional area of 0.5 to 1.25 mm² for wiring.

Furthermore, do not allow excessive force to be applied to the lines.

2. Use electrical circuits which do not generate chattering in their contacts.

3. Use voltage which is within ±10% of the rated voltage.

In cases with a DC power supply where importance is placed on responsiveness, stay within ±5% of the rated value. The voltage drop is the value in the lead wire section connecting the coil.

Electrical Connections

⚠ Caution

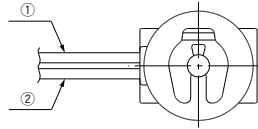

Rated voltage	Lead wire color	
	1	2
DC	Black	Red
100 VAC	Blue	Blue
200 VAC	Red	Red
Other AC	Gray	Gray

* There is no polarity for DC.

* Lead wire: AWG20, outside diameter of insulator 1.79

Electrical Circuit

⚠ Caution

DC circuit

AC circuit

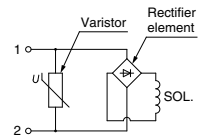
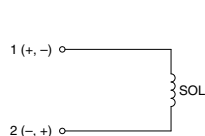



VDW Series

Specific Product Precautions 3

Be sure to read this before handling the products.

Refer to back page 50 for Safety Instructions and pages 17 to 19 for 2 Port Solenoid Valve for Fluid Control Precautions.

The production of the VDW10/20/30 series was discontinued.
(Except for VDW10/20 manifold and 3 port type)
For details about new series: VDW10/20 → page 453
VDW30 → VX2 series

Operating Environment

Warning

1. Do not use the valves in an atmosphere having corrosive gases, chemicals, salt water, water, steam, or where there is direct contact with any of these.
2. Do not use in explosive atmospheres.
3. Do not use in locations subject to vibration or impact.
4. Do not use in locations where radiated heat will be received from nearby heat sources.
5. Employ suitable protective measures in locations where there is contact with water droplets, oil or welding spatter, etc.

Maintenance

Warning

1. Perform maintenance according to the procedure in the operation manual.

Incorrect handling will cause damage or malfunction to devices or equipment.

2. Removing the product

- 1) Shut off the fluid supply and release the fluid pressure in the system.
- 2) Shut off the power supply.
- 3) Dismount the product.

3. Low frequency operation

Switch valves at least once every 30 days to prevent malfunction. Also, in order to use it under the optimum state, conduct a regular inspection once a half year.

Caution

1. Filters and strainers

- 1) Be careful regarding clogging of filters and strainers.
- 2) Replace filter elements after one year of use, or earlier if the pressure drop reaches 0.1 MPa.
- 3) Clean strainers when the pressure drop reaches 0.1 MPa.
- 4) Exhaust the drain from an air filter periodically.

2. Storage

When not using for a long time (more than approx. one month) after use with water, thoroughly remove all moisture to prevent rust and deterioration of rubber materials, etc.

Replacing the Solenoid Coils

Caution

2 port valve

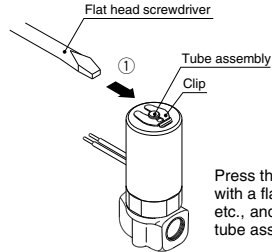

Press the clip in direction ① with a flat head screwdriver, etc., and remove it from the tube assembly groove.

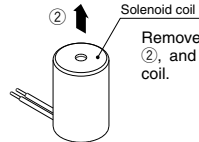

Remove the cover in direction ②, and replace the solenoid coil.

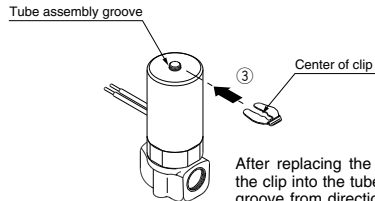
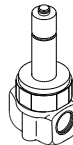

After replacing the coil, insert the clip into the tube assembly groove ③. After inserting it into the groove, confirm the position and condition of the clip.

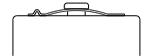

Inserted position

Inserted condition

VCH □

VDW

SX10

VQ

LVM



VDW Series Specific Product Precautions 4

Be sure to read this before handling the products.
Refer to back page 50 for Safety Instructions and pages 17 to 19 for 2 Port Solenoid Valve for Fluid Control Precautions.

The production of the VDW10/20/30 series was discontinued.
(Except for VDW10/20 manifold and 3 port type)
For details about new series: VDW10/20 → page 453
VDW30 → VX2 series

Replacing the Solenoid Coils

Caution

3 port valve

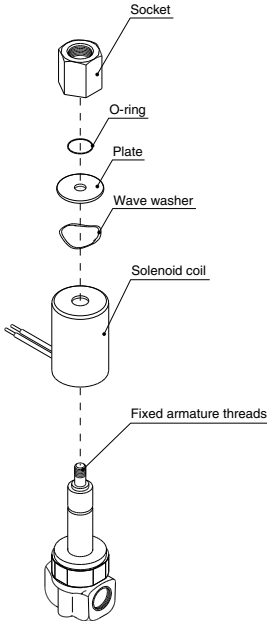

After removing the socket with a wrench, etc., lift off the plate, wave washer and cover, and replace the coil assembly. After replacing the coil, first tighten the socket by hand while holding down the plate and wave washer, and then tighten it further with a torque of 0.8 to 1 N·m.

- * Precautions when attaching and removing the socket
- Be careful that the O-ring installed on the bottom (plate side) of the socket does not fall out or become chewed up, etc.
- Be sure to secure the body by wrench, etc., and tighten the socket within the tightening torque range given above. If the torque is applied excessively, there is a danger of damaging the threads.

Replacement Parts

- Solenoid coil part no.

VDW **2** 0-1 **C** 1-1-□

Series

1	10
2	20, 200
3	30, 300

Coil type

C	Grommet / Tape winding
F	Flat terminal / Molded
W	Grommet / Molded

Type

1	10, 20, 30
2	200, 300

Lead wire length

Nil	300 mm
L1 (Note)	600 mm

Note) Type L1 is optional.

Voltage

1	100 VAC
2	200 VAC
3	110 VAC
4	220 VAC
5	24 VDC
6	12 VDC
V	6 VDC
S	5 VDC
R	3 VDC

Coil Type and Voltage Combinations

Voltage	Grommet / Tape winding	Flat terminal / Molded	Grommet / Molded
100 VAC	●	—	●
200 VAC	●	—	●
110 VAC	●	—	●
220 VAC	●	—	●
24 VDC	●	●	●
12 VDC	●	●	●
6 VDC	●	●	●
5 VDC	●	●	●
3 VDC	●	●	●

Note) To have a label on the cover, enter the part number below together with the coil part number.

AZ-T-VDW Valve model no. on pages 473, 478, 484

- Clip part no. (2 port)

VDW **2** 0-10

Series

2	10, 20
---	--------

- Socket assembly part no. (3 port)

VDW **2** 0-12A-01 □ - □

Series

2	200
3	300

Port size

Symbol	Port size	Series	
		200	300
M5	M5	○	—
01	1/8 (6A)	○	○
02	1/4 (8A)	—	○

Material

Symbol	Socket material	Seal material
Nil	Brass (C37)	NBR
A		FKM
B		EPDM
G	Stainless steel	NBR
H		FKM
J		EPDM
L		FKM

Thread type

Nil	Rc
F	G
N	NPT



VDW Series

Specific Product Precautions 5

Be sure to read this before handling the products.

Refer to back page 50 for Safety Instructions and pages 17 to 19 for 2 Port Solenoid Valve for Fluid Control Precautions.

The production of the VDW10/20/30 series was discontinued.
(Except for VDW10/20 manifold and 3 port type)
For details about new series: VDW10/20 → page 453
VDW30 → VX2 series

Piping to 3 Port Valve N.O. Port

⚠ Caution

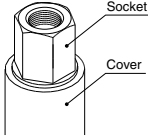

When piping to an N.O. port, be sure to perform piping work while securing the socket by using wrench or other tool. Refer to back page 491 for other precautions related to piping.

Fluid Flow Direction

⚠ Caution

The maximum operating pressure differential differs depending on the flow direction of the fluid. If the pressure differential at each port exceeds the values in the table below, valve leakage may occur.

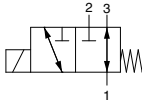

3 Port Valve

Model	Orifice diameter (mm ø)	Max. operating pressure differential (MPa)	
		Pressure port 1	Pressure port 2, 3 ^{Note 1)}
VDW200	1	0.9	0.3
	1.6	0.7	0.1
VDW300	2	0.8	0.2
	3	0.4	0.1
	4	0.2	0.05

Note 1) Indicates the maximum operating pressure differential of pressure ports 2 and 3.

Note 2) When the port 2 pressure is in the higher pressure side, be careful to avoid vibration and impacts, etc.

VCH □

VDW

SX10

VQ

LVM