



Air Gripper Unit for Collaborative Robots

Compliant with the TM Series
OMRON Corporation collaborative robot
and the TM Series
TECHMAN ROBOT Inc. collaborative robot

Plug and Play
configuration for immediate use

TMComponent Easy programming

TMPlug&Play
CERTIFIED



JMHZ2-X7400B-TM



More information
can be viewed here.

P-E20-19

Plug and Play

Air Gripper Unit for Collaborative Robots

OMRON Corporation and TECHMAN ROBOT Inc.

TM5, TM12, and TM14 compliant



- Compact, lightweight product with high gripping force due to air operation
- An air gripper that realizes high rigidity and high precision due to its guide-integrated construction

With high-precision linear guide

Repeatability: ± 0.01 mm

Linear guide of the higher rigidity and precision is used.

Higher rigidity (Compared with the same size of the existing MHZ2)

- Operate by simply connecting 1 air supply tube and an electrical wiring M8 connector.
- Integrated solenoid valve, speed adjustment mechanism, and auto switch
- TMComponent
- A split protective cover for easy air gripper maintenance

Allows you to maintain the air gripper without removing the user-specific attachment

Component Parts

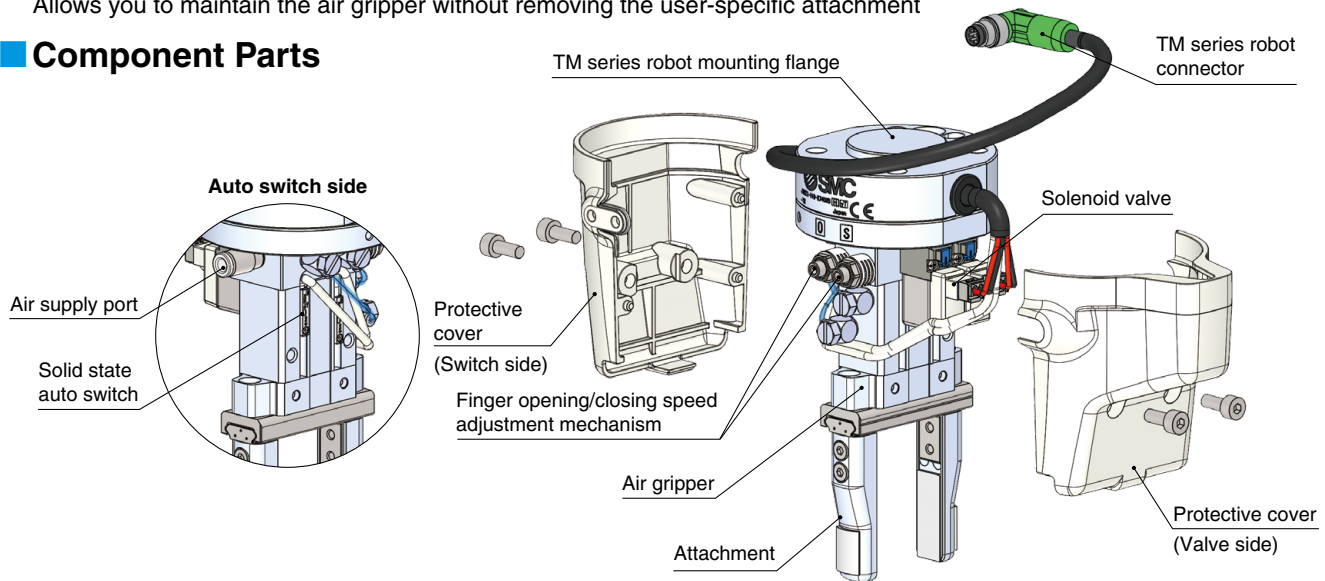

How to Order



JMHZ2-16D-X7400B-TM

Specifications

Bore size [mm]	16	
Fluid	Air	
Action	Double acting	
Operating pressure [MPa]	0.1 to 0.7	
Repeatability [mm]	± 0.01	
Number of fingers	2	
Gripping force	External	32.7
Effective value per finger [N]	Internal	43.5
Opening/Closing stroke (Both sides) [mm]	10	
Weight [g]	430	
Standards	ISO 9409-1-50-4-M6	
Auto switch model	D-M9N-5	
Connector type	M8 8-pin connector (Plug)	

■ Included parts: Piping tube (2 m)

Model Selection

Gripping force

● Indication of effective gripping force

The gripping force shown in the graphs below represents the gripping force of one finger when all fingers and attachments are in contact with the workpiece. **F** = One finger thrust

External gripping force

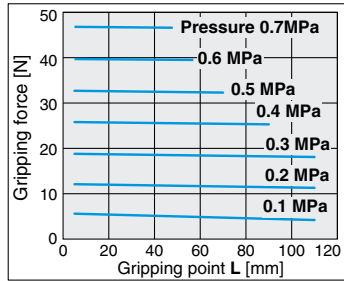
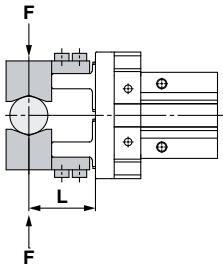

Internal gripping force

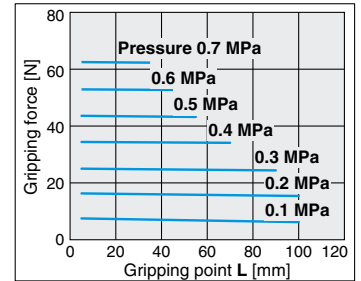
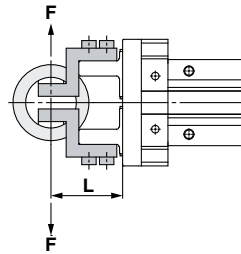

Gripping point

- The air gripper should be operated so that the workpiece gripping point "L" and the amount of overhang "H" stay within the range shown for each operating pressure given in the graphs below.
- If the workpiece gripping point goes beyond the range limits, this will have an adverse effect on the life of the air gripper.

External grip

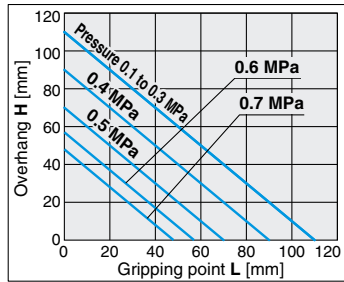
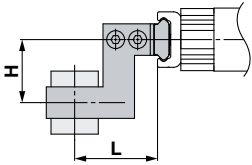

Internal grip

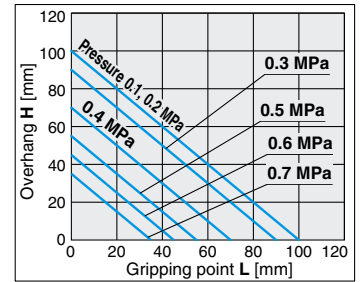
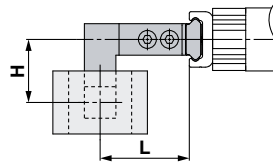

Dimensions

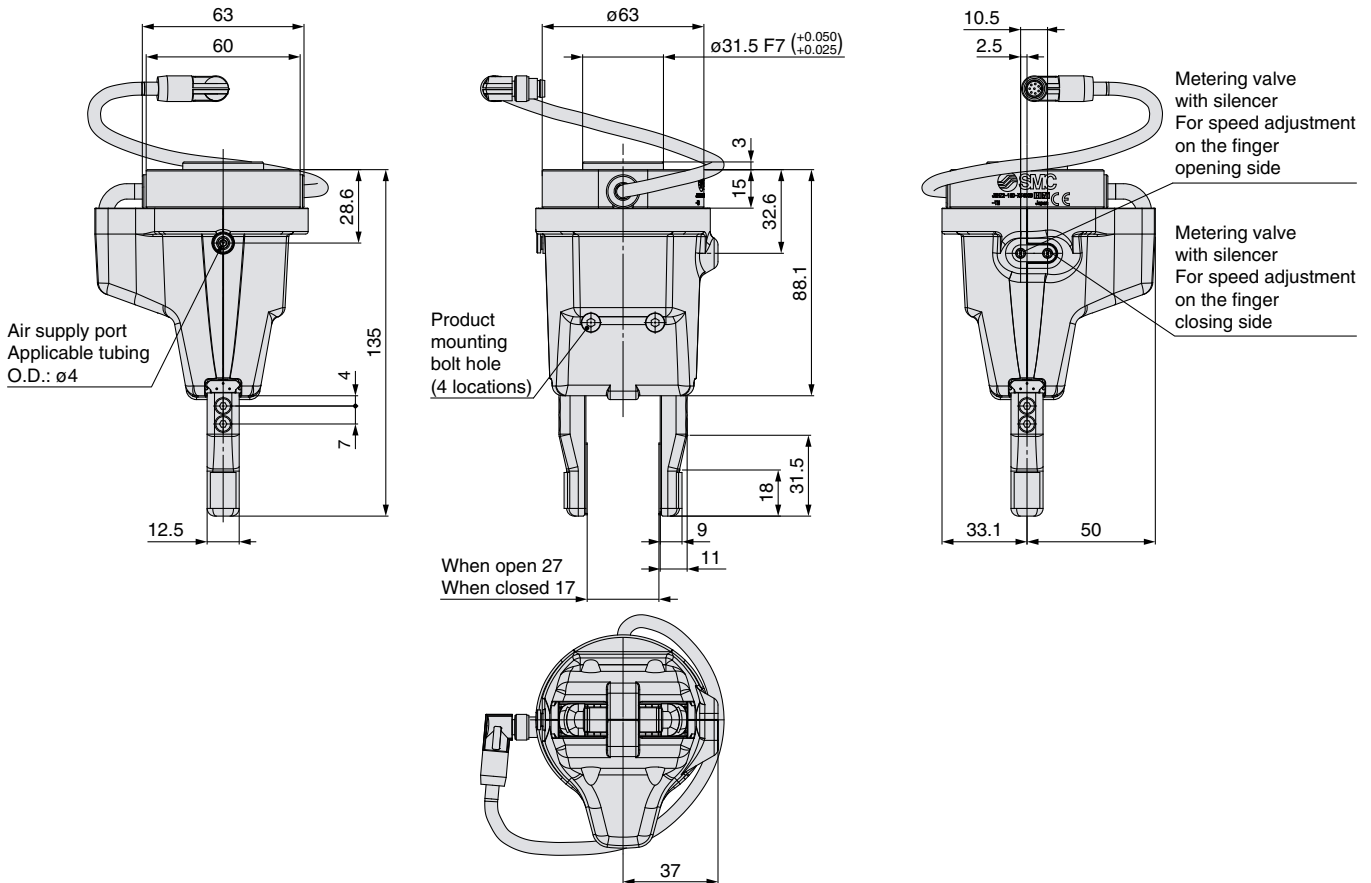

TMComponent

More information
on the TMComponent
software can be
viewed here.



Easy programming

Using the certified software TMComponent of OMRON Corporation and TECHMAN ROBOT Inc., various operations and sensor signals can be easily programmed by using a control box equipped with the dedicated software tool “TMflow” or by using graphical flowcharts on a Windows computer.

You can easily install the software by inserting a USB with the TMComponent software package into a control box or Windows computer.

* Please download the TMComponent software package from the SMC website, and save it to a USB memory.

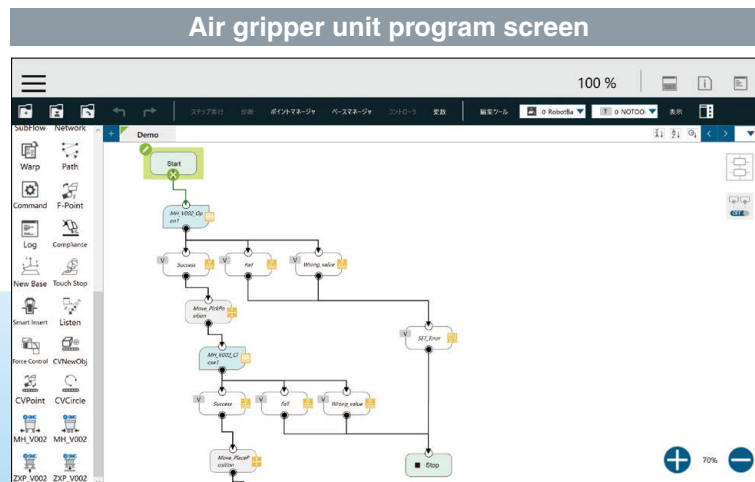
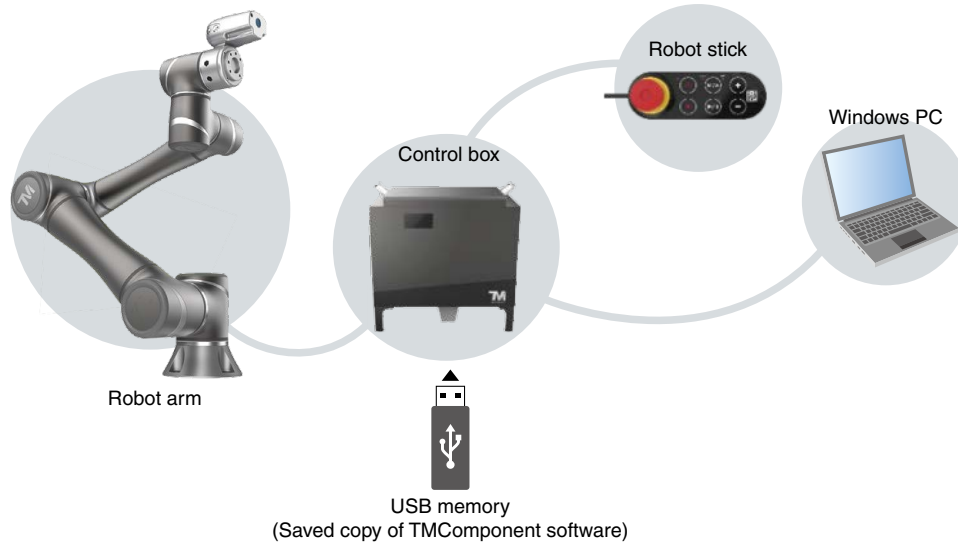

⚠ Safety Instructions Be sure to read the “Handling Precautions for SMC Products” (M-E03-3) and “Operation Manual” before use.