

# Dust-tight/Water-jet-proof (IP65 Equivalent/IP67 Equivalent) Battery-less Absolute Encoder Type Electric Actuator/Rod Type

**Enclosure: IP65<sup>\*1</sup> equivalent/IP67 equivalent**

**Scraper**

**Lube-retainer**  
Retains grease oil film

**Metal connector**  
Prevents dust and water droplets from entering between the cable and motor cover

**Aluminum cover**  
Protects the motor

**Grease supply holes**

**Tubing**  
\* Order the tubing separately.

**Vent hole**  
Reduces internal pressure fluctuations in order to prevent dust and water droplets from entering the device  
\* Be sure to attach tubing.

**Mounting groove for auto switches**  
Water-resistant type  
For checking the limit and the intermediate signal  
\* Order the water-resistant 2-color indicator solid state auto switch separately.

<sup>\*1</sup> Testing of IP65 has also been carried out.

## Battery-less absolute encoder compatible

**Application Examples**

For pushing operations

For delivery

**LEY-X8 Series**



# LEY-X8 Series Enclosure

## Degrees of Protection

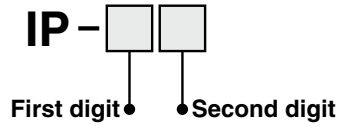

### First Digit: Degree of protection against solid foreign objects

Degrees	Degree of protection
0	Not protected
1	Protected against solid foreign objects of 50 mmø and larger
2	Protected against solid foreign objects of 12 mmø and larger
3	Protected against solid foreign objects of 2.5 mmø and larger
4	Protected against solid foreign objects of 1.0 mmø and larger
5	Dust protected
6	Dust-tight

### Second Digit: Degree of protection against water

Degrees	Degree of protection	
0	Not protected	—
1	Protected against vertically falling water droplets	Dripproof type 1
2	Protected against vertically falling water droplets when enclosure is tilted up to 15°	Dripproof type 2
3	Protected against rainfall when enclosure is tilted up to 60°	Rainproof type
4	Protected against splashing water	Splashproof type
5	Protected against water jets	Water-jet-proof type
6	Protected against powerful water jets	Powerful water-jet-proof type
7	Protected against the effects of temporary immersion in water	Immersible type
8	Protected against the effects of continuous immersion in water	Submersible type

### Example) Degrees of protection

Degrees of protection			Details
IP65	Solid foreign objects	Dust-tight	Dust particles are prevented from entering the device.
	Entry of water	Water-jet-proof*1	The direct application of water jets to the device from any direction will not cause any damage.
IP67	Solid foreign objects	Dust-tight	Dust particles are prevented from entering the device.
	Entry of water	Immersible*1	The amount of water that enters the device when the actuator (in the stopped state) is submersed in up to 1 m of water for up to 30 mins will not cause any damage.

\*1 Be sure to take appropriate protective measures if the product is to be used in an environment where it will be constantly exposed to water or fluids other than water splash. In particular, the product cannot be used in environments where oils, such as cutting oil or cutting fluid, are present.

# Model Selection

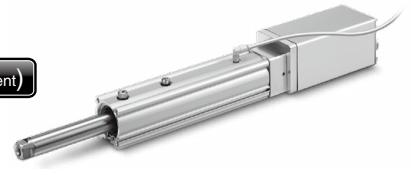

## Speed-Work Load Graph (Guide)

### Horizontal

**LEY25□E-X8**    ▨ for acceleration/deceleration: 2000 mm/s<sup>2</sup>

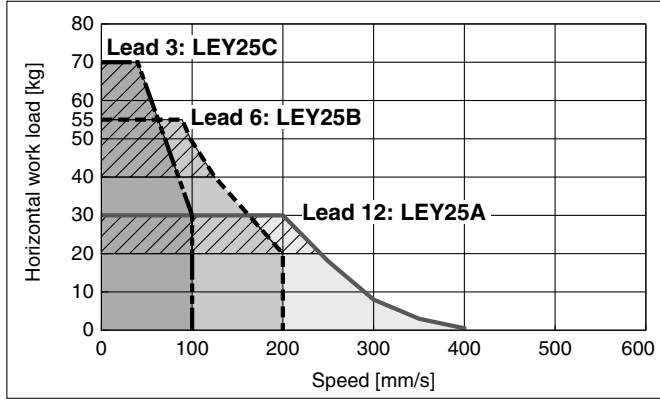

### Vertical

**LEY25□E-X8**

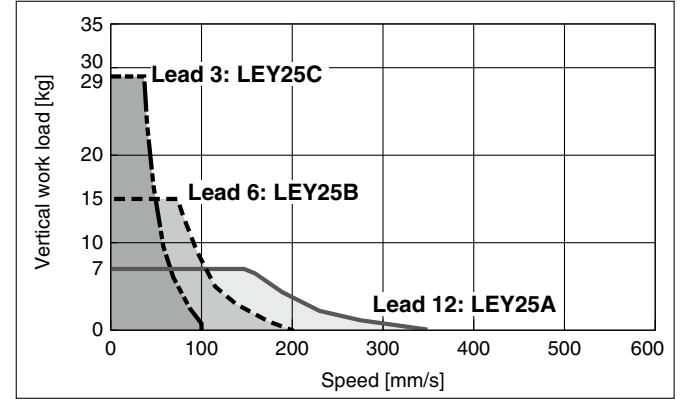

**LEY32□E-X8**    ▨ for acceleration/deceleration: 2000 mm/s<sup>2</sup>

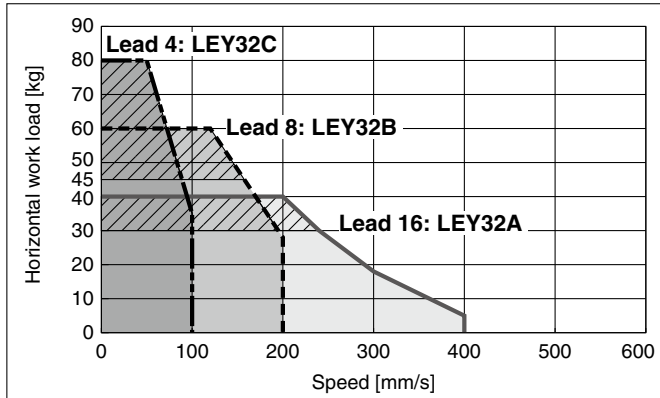

**LEY32□E-X8**

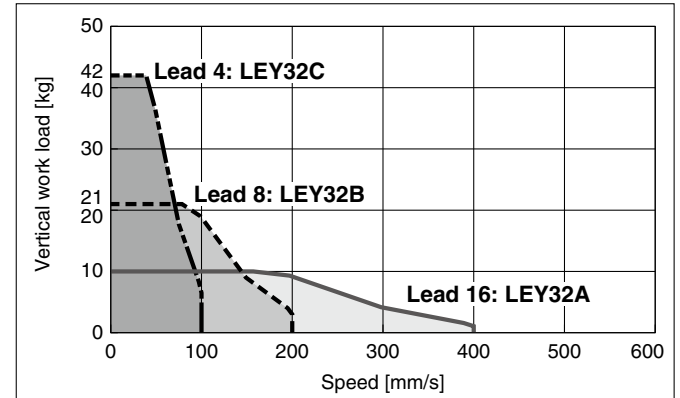

**LEY40□E-X8**    ▨ for acceleration/deceleration: 2000 mm/s<sup>2</sup>

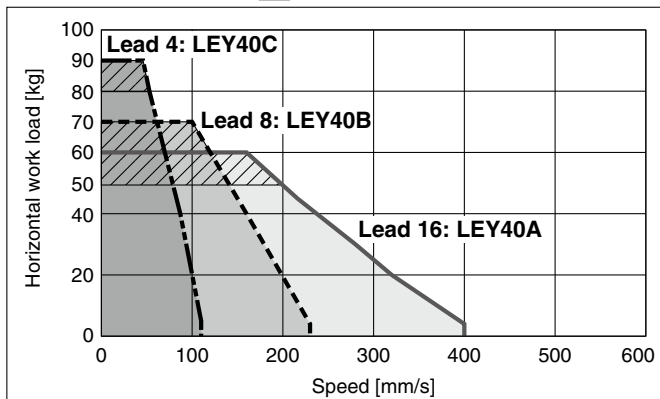

**LEY40□E-X8**

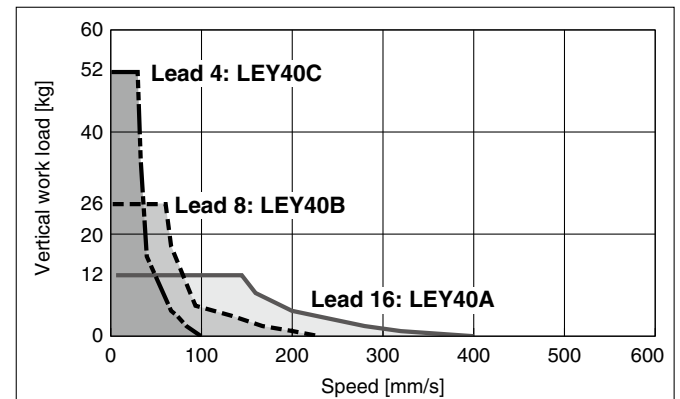

# LEY-X8 Series

Battery-less Absolute (Step Motor 24 VDC)

Dust-tight/Water-jet-proof (IP65 Equivalent/IP67 Equivalent)

Items not listed are the same as those of the standard product. For details, refer to the **Web Catalog**.

## Force Conversion Graph (Guide)

### Battery-less Absolute (Step Motor 24 VDC)

#### LEY25□E-X8

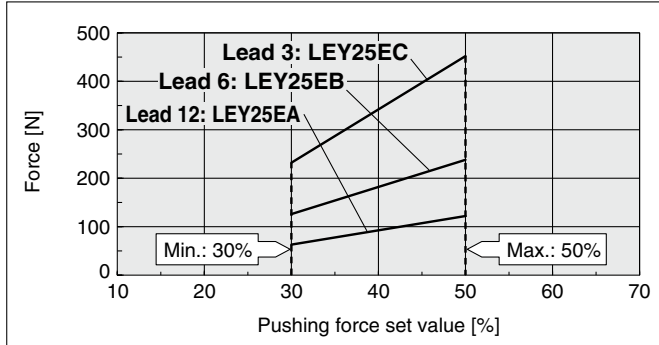

Ambient temperature	Pushing force set value [%]	Duty ratio [%]	Continuous pushing time [min]
40°C or less	50 or less	100	No restriction

#### LEY32□E-X8

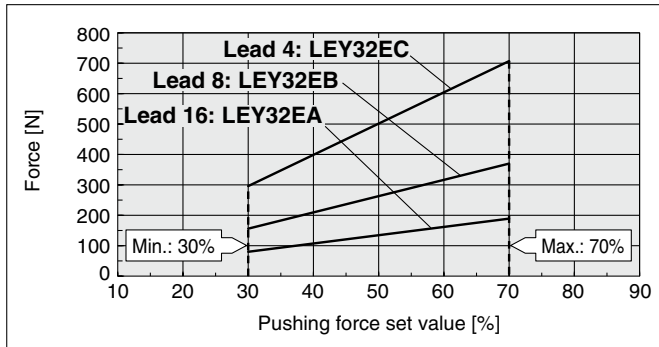

Ambient temperature	Pushing force set value [%]	Duty ratio [%]	Continuous pushing time [min]
40°C or less	70 or less	100	No restriction

#### LEY40□E-X8

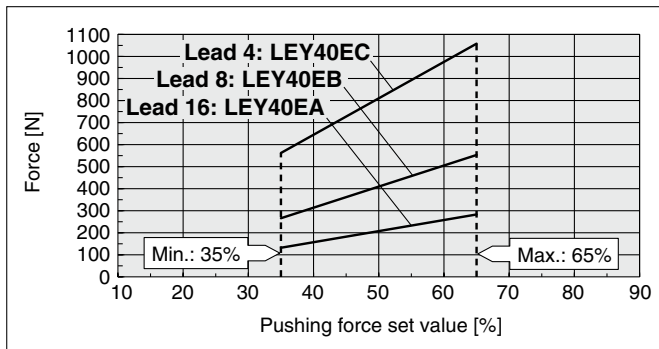

Ambient temperature	Pushing force set value [%]	Duty ratio [%]	Continuous pushing time [min]
40°C or less	65 or less	100	No restriction

### <Limit Values for Pushing Force and Trigger Level in Relation to Pushing Speed>

Model	Lead	Pushing speed [mm/s]	Pushing force (Setting input value)
LEY25□E	A/B/C	21 to 35	40 to 50%
LEY32□E	A	24 to 30	50 to 70%
	B/C	21 to 30	
LEY40□E	A	24 to 30	50 to 65%
	B/C	21 to 30	

### <Set Values for Vertical Upward Transfer Pushing Operations>

Model	LEY25□E			LEY32□E			LEY40□E			
	Lead	A	B	C	A	B	C	A	B	C
Work load [kg]		2.5	5	10	4.5	9	18	7	14	28
Pushing force		50%			70%			65%		

## Graph of Allowable Lateral Load on the Rod End (Guide)

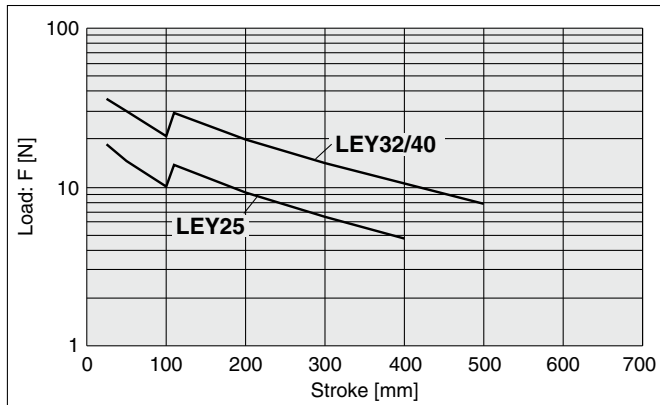

[Stroke] = [Product stroke] + [Distance from the rod end to the center of gravity of the workpiece]

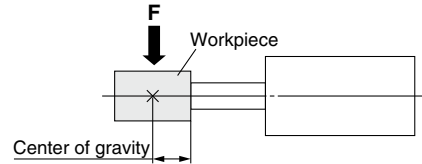

## Rod Displacement: $\delta$ [mm]

Stroke \ Size	30	50	100	150	200	250	300	350	400	450	500
<b>25</b>	±0.3	±0.4	±0.7	±0.7	±0.9	±1.1	±1.3	±1.5	±1.7	—	—
<b>32/40</b>	±0.3	±0.4	±0.7	±0.6	±0.8	±1.0	±1.1	±1.3	±1.5	±1.7	±1.8

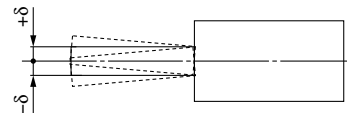

## Non-rotating Accuracy of Rod

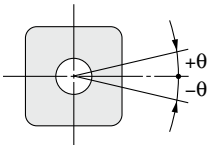

Size	Non-rotating accuracy $\theta$
<b>25</b>	±0.8°
<b>32/40</b>	±0.7°

\* Avoid using the electric actuator in such a way that rotational torque would be applied to the piston rod.

This may cause the deformation of the non-rotating guide, abnormal auto switch responses, play in the internal guide, or an increase in the sliding resistance.

# Dust-tight/Water-jet-proof (IP65 Equivalent/IP67 Equivalent)

## Electric Actuator/Rod Type



### LEY-X8 (Made to Order) Series LEY25/32/40

Refer to pages 2 to 4 for model selection.

### How to Order

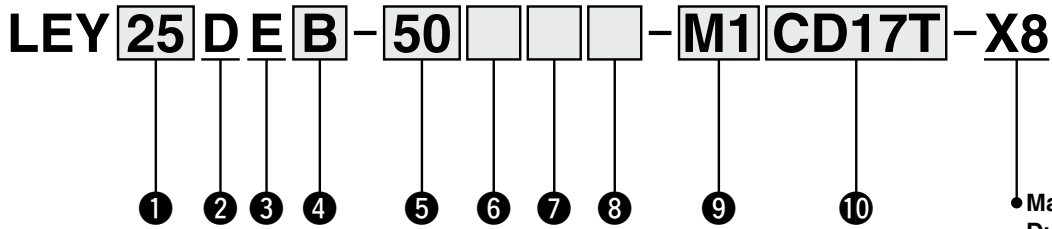
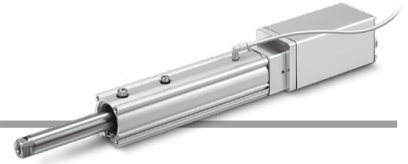

● Made to order:  
Dust-tight/  
Water-jet-proof

For details on controllers,  
refer to page 6.

#### 1 Size

25
32/40

#### 2 Motor mounting position

D	In-line
---	---------

#### 3 Motor type

E	Battery-less absolute (Step motor 24 VDC)
---	--

#### 4 Lead [mm]

Symbol	LEY25	LEY32/40
A	12	16
B	6	8
C	3	4

#### 5 Stroke [mm]

30	30
to	to
500	500

\* For details, refer to the applicable stroke table below.

#### 6 Motor option

Nil	Without option
B	With lock

#### 7 Rod end thread

Nil	Rod end female thread
M	Rod end male thread (1 rod end nut is included.)

#### 8 Mounting\*2

Symbol	Type	Motor mounting position
		In-line
Nil	Ends tapped/ Body bottom tapped*3	●
F	Rod flange*3	●

#### 9 Actuator cable type/length

Robotic cable				[m]
MN	None	M8	8*4	
M1	1.5	MA	10*4	
M3	3	MB	15*4	
M5	5	MC	20*4	

#### Applicable Stroke Table\*1

●: Standard

Model	Stroke [mm]	30	50	100	150	200	250	300	350	400	450	500	Manufacturable stroke range
LEY25		●	●	●	●	●	●	●	●	●	—	—	30 to 400
LEY32/40		●	●	●	●	●	●	●	●	●	●	●	30 to 500

\* For auto switches, refer to page 12.

\* "-X8" is not added to an actuator model with a controller part number suffix.  
Example) "LEY25DEB-100" for the LEY25DEB-100M-M1CD17T-X8

# Electric Actuator/Rod Type **LEY-X8 Series**

Battery-less Absolute (Step Motor 24 VDC)

Dust-tight/Water-jet-proof (IP65 Equivalent/IP67 Equivalent)

## ⑩ Controller

Nil	Without controller
C□1□□	With controller

**C D 1 7 T**

Interface  
(Communication protocol/Input/Output)

<b>E</b>	EtherCAT®
<b>9</b>	EtherNet/IP™
<b>P</b>	PROFINET
<b>D</b>	DeviceNet™
<b>L</b>	IO-Link
<b>M</b>	CC-Link Ver. 1.10
<b>5</b>	Parallel input (NPN)
<b>6</b>	Parallel input (PNP)

Mounting

<b>7</b>	Screw mounting
<b>8</b> *5	DIN rail

For single axis

Communication plug connector I/O cable\*6

Symbol	Type	Applicable interface
Nil	Without accessory	—
<b>S</b>	Straight type communication plug connector	DeviceNet™ CC-Link Ver. 1.10
<b>T</b>	T-branch type communication plug connector	
<b>1</b>	I/O cable (1.5 m)	Parallel input (NPN) Parallel input (PNP)
<b>3</b>	I/O cable (3 m)	
<b>5</b>	I/O cable (5 m)	

- \*1 Please consult with SMC for non-standard strokes as they are produced as special orders.
- \*2 The mounting bracket is shipped together with the product but does not come assembled.
- \*3 For the horizontal cantilever mounting of the rod flange, or ends tapped types, use the actuator within the following stroke range.  
· LEY25: 200 or less · LEY32/40: 100 or less

- \*4 Produced upon receipt of order
- \*5 The DIN rail is not included. It must be ordered separately.
- \*6 Select "Nil" for anything other than DeviceNet™, CC-Link, or parallel input.  
Select "Nil," "S," or "T" for DeviceNet™ or CC-Link.  
Select "Nil," "1," "3," or "5" for parallel input.

### ⚠ Caution

#### [CE-compliant products]

EMC compliance was tested by combining the electric actuator LEY series and the controller JXC series.

The EMC depends on the configuration of the customer's control panel and the relationship with other electrical equipment and wiring. Therefore, compliance with the EMC directive cannot be certified for SMC components incorporated into the customer's equipment under actual operating conditions. As a result, it is necessary for the customer to verify compliance with the EMC directive for the machinery and equipment as a whole.

#### [Precautions relating to differences in controller versions]

When the JXC series is to be used in combination with the battery-less absolute encoder, use a controller that is version V3.4 or S3.4 or higher. For details, refer to the **Web Catalog**.

### The actuator and controller are sold as a package.

Confirm that the combination of the controller and actuator is correct.

#### <Check the following before use.>

- \*1 Check the actuator label for the model number. This number should match that of the controller.

**LEY25DEB-100**

\*1



- \* Refer to the Operation Manual for using the products. Please download it via our website:  
<https://www.smcworld.com>

Type	EtherCAT® direct input type	EtherNet/IP™ direct input type	PROFINET direct input type	DeviceNet™ direct input type	IO-Link direct input type	CC-Link direct input type	Step data input type
Series	JXCE1	JXC91	JXCP1	JXCD1	JXCL1	JXCM1	JXC51 JXC61
Features	EtherCAT® direct input	EtherNet/IP™ direct input	PROFINET direct input	DeviceNet™ direct input	IO-Link direct input	CC-Link direct input	Parallel I/O
Compatible motor	Battery-less absolute (Step motor 24 VDC)						
Max. number of step data	64 points						
Power supply voltage	24 VDC						



# LEY-X8 Series

Battery-less Absolute (Step Motor 24 VDC)

Dust-tight/Water-jet-proof (IP65 Equivalent/IP67 Equivalent)

## Specifications

### Step Motor (Servo/24 VDC)

Model		LEY25□E-X8			LEY32□E-X8			LEY40□E-X8			
Work load [kg]*1	Horizontal	(3000 [mm/s <sup>2</sup> ])	20	40	60	30	45	60	50	60	80
	Vertical	(2000 [mm/s <sup>2</sup> ])	30	55	70	40	60	80	60	70	90
		(3000 [mm/s <sup>2</sup> ])	7	15	29	10	21	42	12	26	52
Pushing force [N]*2 *3 *4			63 to 122	126 to 238	232 to 452	80 to 189	156 to 370	296 to 707	132 to 283	266 to 553	562 to 1058
Speed [mm/s]*4			18 to 400	9 to 200	5 to 100	24 to 400	12 to 200	6 to 100	24 to 400	12 to 230	6 to 110
Max. acceleration/deceleration [mm/s <sup>2</sup> ]			3000								
Pushing speed [mm/s]*5			35 or less			30 or less			30 or less		
Positioning repeatability [mm]			±0.02								
Lost motion [mm]*6			0.1 or less								
Screw lead [mm]			12	6	3	16	8	4	16	8	4
Impact/Vibration resistance [m/s <sup>2</sup> ]*7			50/20								
Actuation type			Ball screw (LEY□D)								
Guide type			Sliding bushing (Piston rod)								
Enclosure*8			IP65 equivalent/IP67 equivalent*14								
Operating temperature range [°C]			5 to 40								
Operating humidity range [%RH]			90 or less (No condensation)								
Motor size			□42			□56.4			□56.4		
Motor type			Battery-less absolute (Step motor 24 VDC)								
Encoder			Battery-less absolute (4096 pulse/rotation)								
Rated voltage [V]			24 VDC ±10%								
Power consumption [W]*9			40			50			50		
Standby power consumption when operating [W]*10			15			48			48		
Max. instantaneous power consumption [W]*11			48			104			106		
Type*12			Non-magnetizing lock								
Holding force [N]			78	157	294	108	216	421	127	265	519
Power consumption [W]*13			5			5			5		
Rated voltage [V]			24 VDC ±10%								

\*1 Horizontal: The maximum value of the work load. An external guide is necessary to support the load. (Friction coefficient of guide: 0.1 or less) The actual work load and transfer speed change according to the condition of the external guide. Also, speed changes according to the work load. Check the "Model Selection" on page 2.

Vertical : Speed changes according to the work load. Check the "Model Selection" on page 2.

The values shown in ( ) are the acceleration/deceleration. Set these values to be 3000 [mm/s<sup>2</sup>] or less.

\*2 Pushing force accuracy is ±20% (F.S.).

\*3 The pushing force values for LEY25□E are 30% to 50%, for LEY32□E are 30% to 70%, and for LEY40□E are 35% to 65%.

The pushing force values change according to the duty ratio and pushing speed. Check the "Model Selection" on page 3.

\*4 The speed and force may change depending on the cable length, load, and mounting conditions. Furthermore, if the cable length exceeds 5 m, then it will decrease by up to 10% for each 5 m. (At 15 m: Reduced by up to 20%)

\*5 The allowable speed for pushing operations. When push conveying a workpiece, operate at the vertical work load or less.

\*6 A reference value for correcting an error in reciprocal operation

\*7 Impact resistance : No malfunction occurred when the actuator was tested with a drop tester in both an axial direction and a perpendicular direction to the lead screw. (The test was performed with the actuator in the initial state.)

Vibration resistance: No malfunction occurred in a test ranging between 45 to 2000 Hz. The test was performed in both an axial direction and a perpendicular direction to the lead screw. (The test was performed with the actuator in the initial state.)

\*8 Cannot be used in an environment where oil such as cutting oil splashes or it is constantly exposed to water

Take appropriate protective measures. For details on enclosure, refer to the "Enclosure" on page 1.

\*9 The power consumption (including the controller) is for when the actuator is operating.

\*10 The standby power consumption when operating (including the controller) is for when the actuator is stopped in the set position during the operation. Except during the pushing operation

\*11 The maximum instantaneous power consumption (including the controller) is for when the actuator is operating. This value can be used for the selection of the power supply.

\*12 With lock only

\*13 For an actuator with lock, add the power consumption for the lock.

\*14 Excludes the controller body and the connector part on the controller side



## Weight

### Weight: In-line Motor Type

LEY25D										
Stroke	30	50	100	150	200	250	300	350	400	
Product weight [kg]	1.48	1.55	1.72	1.97	2.15	2.32	2.50	2.67	2.85	

LEY32D												
Stroke	30	50	100	150	200	250	300	350	400	450	500	
Product weight [kg]	2.58	2.69	2.98	3.36	3.65	3.94	4.22	4.51	4.80	5.08	5.37	

LEY40D												
Stroke	30	50	100	150	200	250	300	350	400	450	500	
Product weight [kg]	2.93	3.04	3.33	3.71	4.00	4.29	4.57	4.86	5.15	5.43	5.72	

### Additional Weight

[kg]

Size		25	32	40
Lock		0.35	0.65	0.65
Rod end male thread	Male thread	0.03	0.03	0.03
	Nut	0.02	0.02	0.02
Rod flange (including mounting bolt)		0.17	0.20	0.20

# LEY-X8 Series

Battery-less Absolute (Step Motor 24 VDC)

Dust-tight/Water-jet-proof (IP65 Equivalent/IP67 Equivalent)

## Construction

In-line motor type: LEY<sup>25</sup><sub>32D</sub><sub>40</sub>

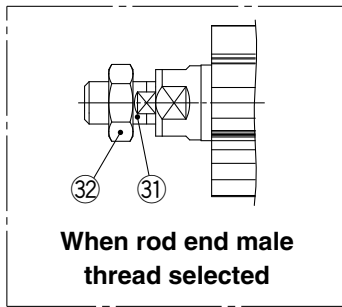
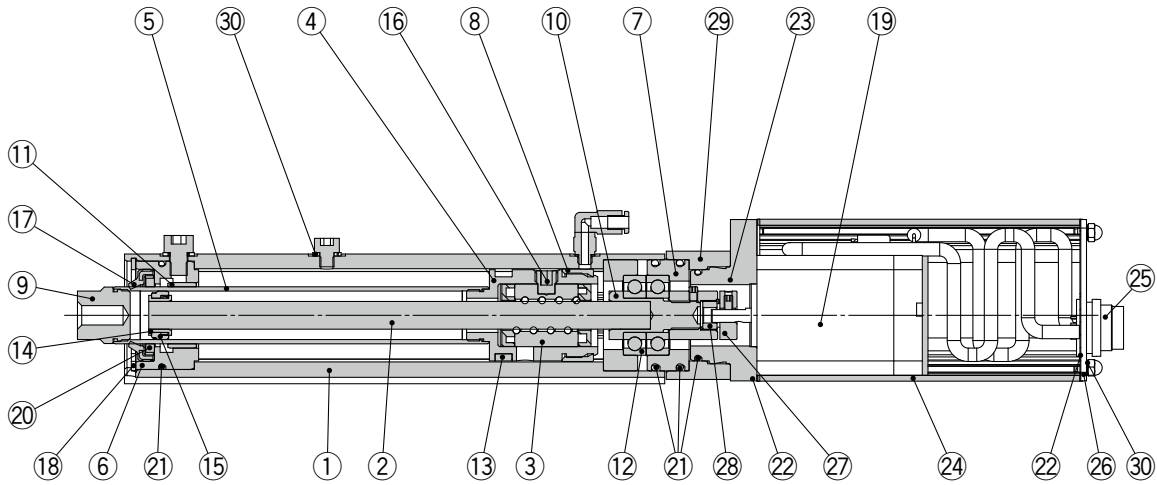

### Component Parts

No.	Description	Material	Note
1	Body	Aluminum alloy	Anodized
2	Ball screw shaft	Alloy steel	
3	Ball screw nut	Synthetic resin/Alloy steel	
4	Piston	Aluminum alloy	
5	Piston rod	Stainless steel	Hard chrome plating
6	Rod cover	Aluminum alloy	Anodized
7	Bearing holder	Aluminum alloy	
8	Rotation stopper	Resin	
9	Socket	Stainless steel	
10	Connected shaft	Free cutting carbon steel	Nickel plating
11	Bushing	Bearing alloy	
12	Bearing	—	
13	Magnet	—	
14	Wear ring holder	Stainless steel	Stroke 101 mm or more
15	Wear ring	Resin	Stroke 101 mm or more
16	Parallel pin	Stainless steel	

No.	Description	Material	Note
17	Greater water resistant scraper	Stainless steel/NBR	
18	Retaining ring	Stainless steel	
19	Motor	—	
20	Lube-retainer	Felt	
21	O-ring	NBR	
22	Gasket	Chloroprene	
23	Motor adapter	Aluminum alloy	LEY25 only
24	Motor cover	Aluminum alloy	Anodized
25	Metal connector	Zinc die-casted	Chrome plating
26	End cover	Aluminum alloy	Anodized
27	Hub	Aluminum alloy	
28	Spider	NBR	
29	Motor block	Aluminum alloy	Anodized
30	Seal washer	Stainless steel/NBR	
31	Socket (Male thread)	Stainless steel	
32	Nut	Stainless steel	

### Replacement Parts/Grease Pack

Applied portion	Order no.
Piston rod	GR-S-010 (10 g)
Piston	GR-S-020 (20 g)

\* Apply grease on the piston rod periodically.  
Grease should be applied at 1 million cycles or 200 km, whichever comes first.

## Dimensions

### In-line motor type

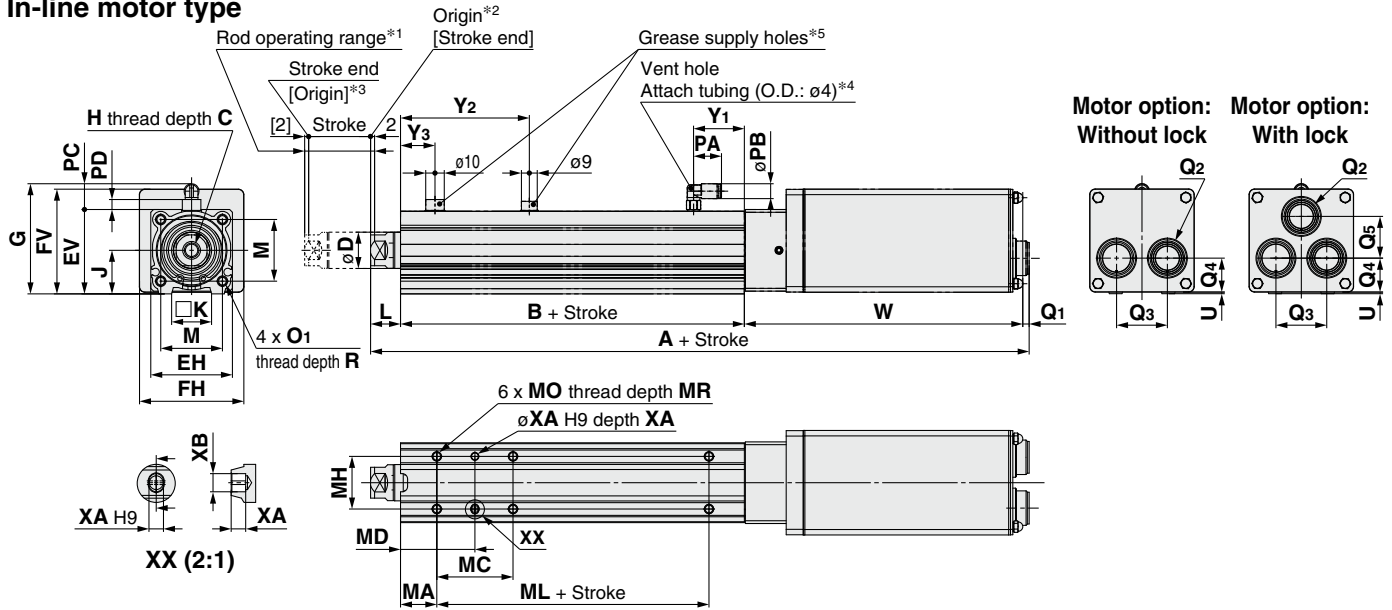

**Rod end male thread: LEY32D□-□□M**  
25  
40

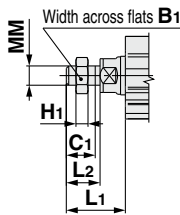

Size	B <sub>1</sub>	C <sub>1</sub>	H <sub>1</sub>	L <sub>1</sub>	L <sub>2</sub>	MM
25	22	20.5	8	38	23.5	M14 x 1.5
32/40	22	20.5	8	42	23.5	M14 x 1.5

\* The L<sub>1</sub> measurement is when the unit is in the original position. At this position, 2 mm at the end.

Size	Stroke range [mm]	A		B	C	D	EH	EV	FH	FV	G	H	J	K	L	M	O <sub>1</sub>	R
		Without lock	With lock															
25	30 to 100	262.5	312.5	89.5	13	20	44	45.5	57.6	57.7	61.4	M8 x 1.25	24	17	14.5	34	M5 x 0.8	8
	105 to 400	287.5	337.5															
32	30 to 100	273	323	96	13	25	51	56.5	69.6	79.6	72.4	M8 x 1.25	31	22	18.5	40	M6 x 1.0	10
	105 to 500	303	353															
40	30 to 100	295	355	96	13	25	51	56.5	69.6	79.6	72.4	M8 x 1.25	31	22	18.5	40	M6 x 1.0	10
	105 to 500	325	375															

Size	Stroke range [mm]	PA	PB	PC	PD	Q <sub>1</sub>	Q <sub>2</sub>		Q <sub>3</sub>	Q <sub>4</sub>	Q <sub>5</sub>		U	W		Y <sub>1</sub>	Y <sub>2</sub>	Y <sub>3</sub>
							Without lock	With lock			Without lock	With lock		Without lock	With lock			
25	30 to 100	15.4	8.2	15.9	6.5	3.5	2 x ø22	3 x ø22	28	18.7	—	23	0.9	155	205	28	71	19
	105 to 400																	
32	30 to 100	15.4	8.2	15.9	7.1	3.5	2 x ø22	3 x ø22	36	28	—	32	1	155	205	30	75.5	16
	105 to 500																	
40	30 to 100	15.4	8.2	15.9	7.1	3.5	2 x ø22	3 x ø22	36	28	—	32	1	177	227	30	75.5	16
	105 to 500																	

### Body Bottom Tapped

Size	Stroke range [mm]	MA	MC	MD	MH	ML	MO	MR	XA	XB
25	30 to 39	20	24	32	29	50	M5 x 0.8	6.5	4	5
	40 to 100		42	41		75				
	101 to 124		59	49.5						
	125 to 200		76	58						
	201 to 400									
32/40	30 to 39	25	22	36	30	50	M6 x 1	8.5	5	6
	40 to 100		36	43		80				
	101 to 124		53	51.5						
	125 to 200		70	60						
	201 to 500									

- \*1 This is the range within which the rod can move when it returns to origin. Make sure workpieces mounted on the rod do not interfere with the workpieces and facilities around the rod.
- \*2 Position after returning to origin
- \*3 [ ] for when the direction of return to origin has changed
- \*4 The vent hole is the port for releasing to atmosphere. Do not apply pressure to this hole.  
Attach tubing to the vent hole and place the end of the tubing so it is not exposed to dust or water.
- \*5 It is recommended to take appropriate protective measures if the product is to be used in an environment where fluids other than water splash.  
In particular, the product cannot be used in environments where cutting oil, cutting fluid, etc., are present.
- \* The direction of rod end width across flats (□K) differs depending on the products.

For the mounting bracket dimensions, refer to the **Web Catalog**.

# LEY-X8 Series

Battery-less Absolute (Step Motor 24 VDC)

Dust-tight/Water-jet-proof (IP65 Equivalent/IP67 Equivalent)

## Option: Actuator Cable

[Metal connector robotic cable for battery-less absolute (Step motor 24 VDC)]

### LE-CE-1-X4

Cable length (L) [m]

1	1.5
3	3
5	5
8	8*1
A	10*1
B	15*1
C	20*1

\*1 Produced upon receipt of order

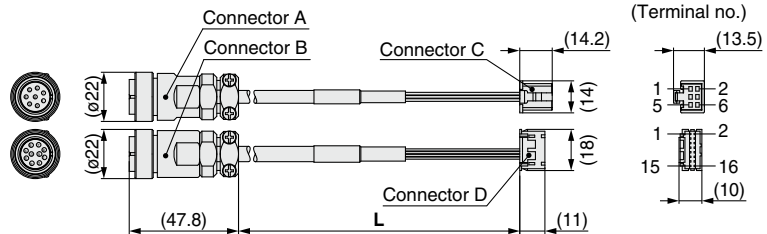

### Weight

Product no.	Weight [g]	Note
LE-CE-1-X4	270	Robotic cable
LE-CE-3-X4	440	
LE-CE-5-X4	650	
LE-CE-8-X4	980	
LE-CE-A-X4	1200	
LE-CE-B-X4	1760	
LE-CE-C-X4	2290	

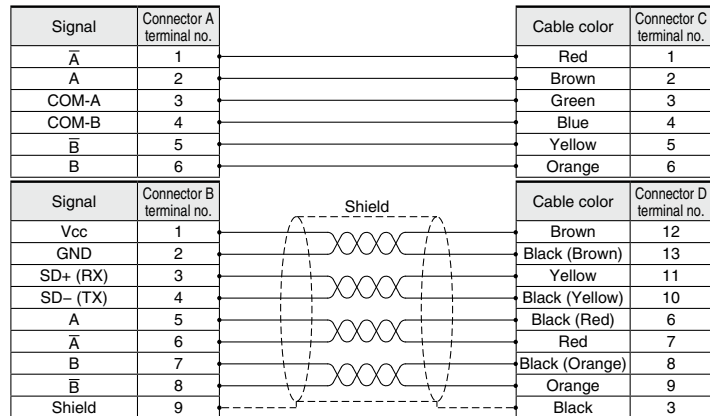

[Metal connector robotic cable with lock for battery-less absolute (Step motor 24 VDC)]

### LE-CE-1-B-X4

Cable length (L) [m]

1	1.5
3	3
5	5
8	8*2
A	10*2
B	15*2
C	20*2

\*2 Produced upon receipt of order

With lock and sensor

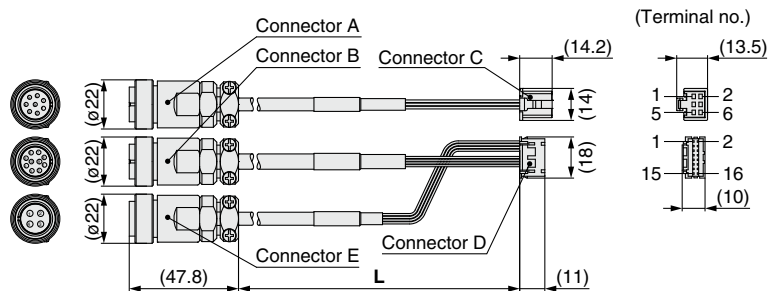

### Weight

Product no.	Weight [g]	Note
LE-CE-1-B-X4	320	Robotic cable
LE-CE-3-B-X4	490	
LE-CE-5-B-X4	700	
LE-CE-8-B-X4	1030	
LE-CE-A-B-X4	1250	
LE-CE-B-B-X4	1810	
LE-CE-C-B-X4	2340	

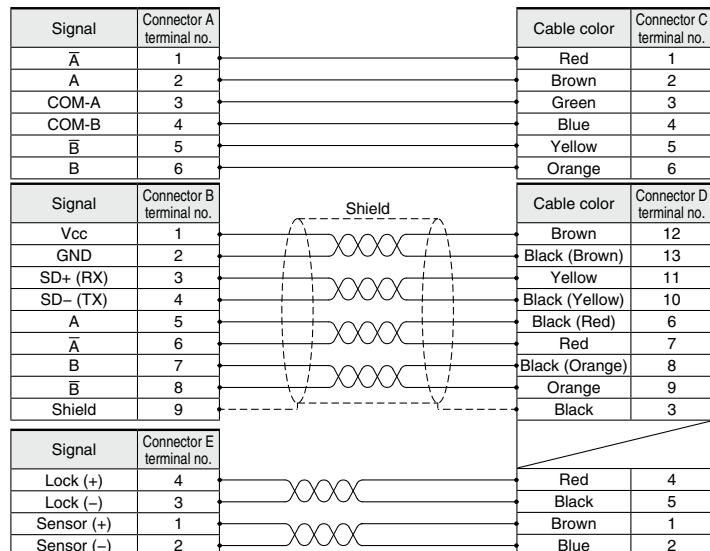

# Water Resistant 2-Color Indicator Solid State Auto Switch: Direct Mounting Type D-M9NA(V)/D-M9PA(V)/D-M9BA(V)

## Grommet

- Water (coolant) resistant type
- 2-wire load current is reduced (2.5 to 40 mA).
- The proper operating range can be determined by the color of the light. (Red → Green ← Red)
- Using flexible cable as standard spec.

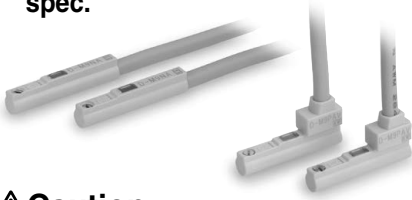

## Caution

### Precautions

Fix the auto switch with the existing screw installed on the auto switch body. The auto switch may be damaged if a screw other than the one supplied is used. Please consult with SMC if using coolant liquid other than water based solution.

## Weight

[g]

Auto switch model	D-M9NA(V)	D-M9PA(V)	D-M9BA(V)
Lead wire length			
0.5 m (Nil)	8	7	
1 m (M)	14	13	
3 m (L)	41	38	
5 m (Z)	68	63	

## Dimensions

[mm]

### D-M9□A

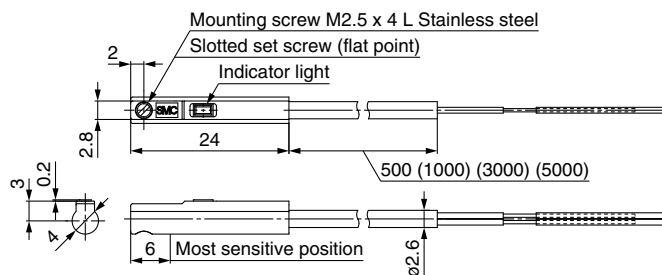

### D-M9□AV

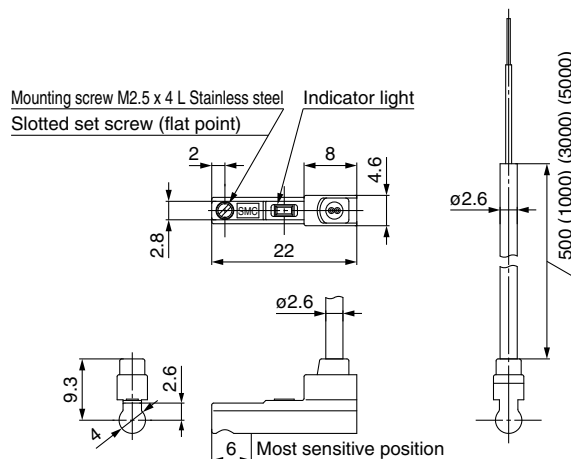

## Auto Switch Specifications

PLC: Programmable Logic Controller

D-M9□A, D-M9□AV (With indicator light)						
Auto switch model	D-M9NA	D-M9NAV	D-M9PA	D-M9PAV	D-M9BA	D-M9BAV
Electrical entry direction	In-line	Perpendicular	In-line	Perpendicular	In-line	Perpendicular
Wiring type	3-wire			2-wire		
Output type	NPN		PNP		—	
Applicable load	IC circuit, Relay, PLC				24 VDC relay, PLC	
Power supply voltage	5, 12, 24 VDC (4.5 to 28 V)				—	
Current consumption	10 mA or less				—	
Load voltage	28 VDC or less		—		24 VDC (10 to 28 VDC)	
Load current	40 mA or less				2.5 to 40 mA	
Internal voltage drop	0.8 V or less at 10 mA (2 V or less at 40 mA)				4 V or less	
Leakage current	100 μA or less at 24 VDC				0.8 mA or less	
Indicator light	Operating range ..... Red LED illuminates. Proper operating range ..... Green LED illuminates.					
Standard	CE marking (EMC directive/RoHS directive)					

## Oilproof Flexible Heavy-duty Lead Wire Specifications

Auto switch model		D-M9NA□	D-M9NAV□	D-M9PA□	D-M9PAV□	D-M9BA□	D-M9BAV□
Sheath	Outside diameter [mm]	2.6					
Insulator	Number of cores	3 cores (Brown/Blue/Black)			2 cores (Brown/Blue)		
	Outside diameter [mm]	0.88					
Conductor	Effective area [mm <sup>2</sup> ]	0.15					
	Strand diameter [mm]	0.05					
Minimum bending radius [mm]		17					

\* Refer to the **Web Catalog** for solid state auto switch common specifications.

\* Refer to the **Web Catalog** for lead wire lengths.

 **Safety Instructions** Be sure to read the "Handling Precautions for SMC Products" (M-E03-3) and "Operation Manual" before use.