

Compact Regulator

ARX20 Series

2.0 MPa compatible, piston type compact regulator



- Compatible with inlet supply pressure of 2.0 MPa
- Compact type (face to face dimensions 35 mm, overall length 80 mm)
- Employs a knob shape for easy operation
- Ideal for discharge pressure adjustment on a small compressor
- Piston type**
- Ideal for pressure adjustment of air blowing applications
- 3 out ports for convenient use

ARJ

AR425
to 935

ARX

AMR

ARM

ARP

IR□-A

IR

IRV

VEX

SRH

SRP

SRF

ITV

IC

ITVH

ITVX

PVQ

VY1

VBA
VBAT

AP100

Compact Regulator

ARX20 Series

How to Order

ARX2 **0** — **01** **□**

Regulator for 2 MPa

Regulating pressure range

0	0.05 to 0.85 MPa
1 Note 1)	0.05 to 0.30 MPa

Thread type

Nll	Rc
N	NPT
F	G

Port size

01	1/8
02	1/4

Option

Nll	None		
B	Bracket	1348112	
G	Pressure gauge Note 2)	ARX20- Nll <input type="checkbox"/> F <input type="checkbox"/>	G36-10-01 G46-10-02
		ARX21- Nll <input type="checkbox"/> F <input type="checkbox"/>	G36-4-01 G46-4-02
	ARX20-N <input type="checkbox"/>	G36-P10-N01-X30 G46-P10-N02-X30	
	ARX21-N <input type="checkbox"/>	G36-P4-N01-X30 G46-P4-N02-X30	
P	Panel nut	1348110A	

Option combination numbers

B	BG	* Panel nut is also included with B.
G	GP	
P		

Note 1) Compared with ARX20, ARX21 is the product which adjusting spring has only been changed.

It is not the product, which does not allow the pressure more than 0.3 MPa.

Note 2) Pressure gauges are shipped together, (but not assembled).

Specifications



Symbol



Model		ARX20
Regulator construction		Piston type regulator
Relief mechanism		Relieving type
Port size		Rc 1/8, 1/4
Pressure gauge port size		Rc 1/8, 1/4
Proof pressure		3.0 MPa
Maximum operating pressure		2.0 MPa
Regulating pressure range	Standard type	0.05 to 0.85 MPa
	Low pressure type	0.05 to 0.3 MPa
Fluid		Air
Ambient and fluid temperature		-5 to 60°C (No freezing)
Weight		110 g

Flow Rate Characteristics (Representative Value)

ARX20-01

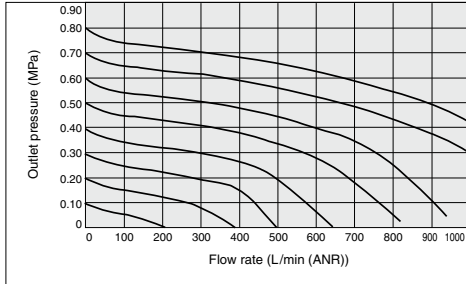

ARX20-02

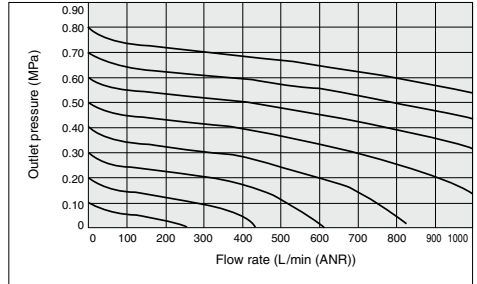

Inlet pressure: 2.0 MPa

ARX21-01

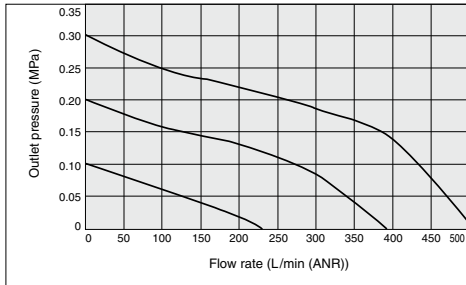

ARX21-02

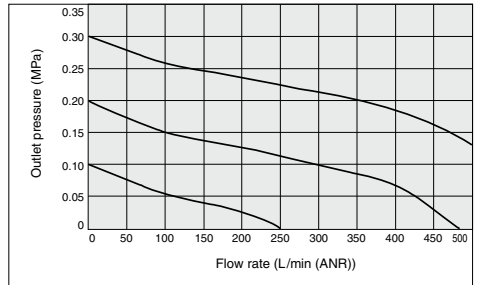

Pressure Characteristics (Representative Value)

ARX20

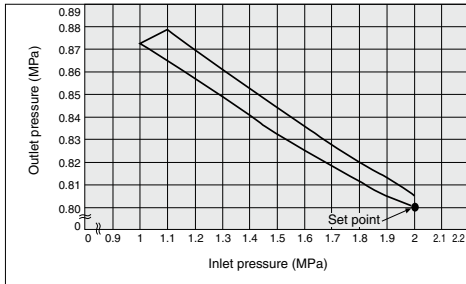

ARX21

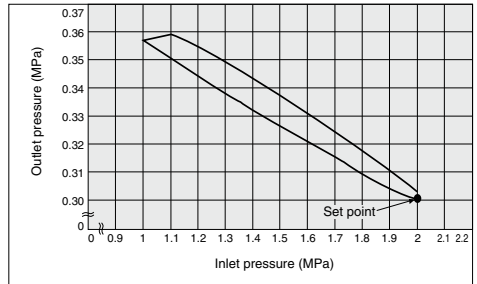

ARJ

AR425
to 935

ARX

AMR

ARM

ARP

IR□-A

IR

IRV

VEX

SRH

SRP

SRF

ITV

IC

ITVH

ITVX

PVQ

VY1

VBA

VBAT

AP100

ARX20 Series

Construction

Symbol

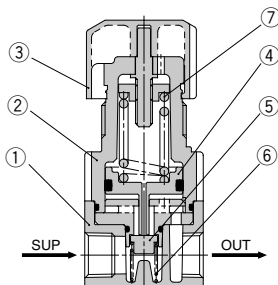
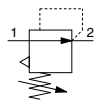

Component Parts

No.	Description	Material	Note
1	Body	ADC	Chromate treated
2	Bonnet	POM	

Replacement Parts

No.	Description	Material	Part no.
3	Knob	POM	1348102#1
4	Piston assembly	POM, NBR	1348104A
5	Valve	Brass, NBR	1348114#1
6	Valve spring	Stainless steel	1348109
7	Adjusting spring	Steel wire	1348108 (For 0.85 MPa) 1348108-1 (For 0.3 MPa)

Dimensions

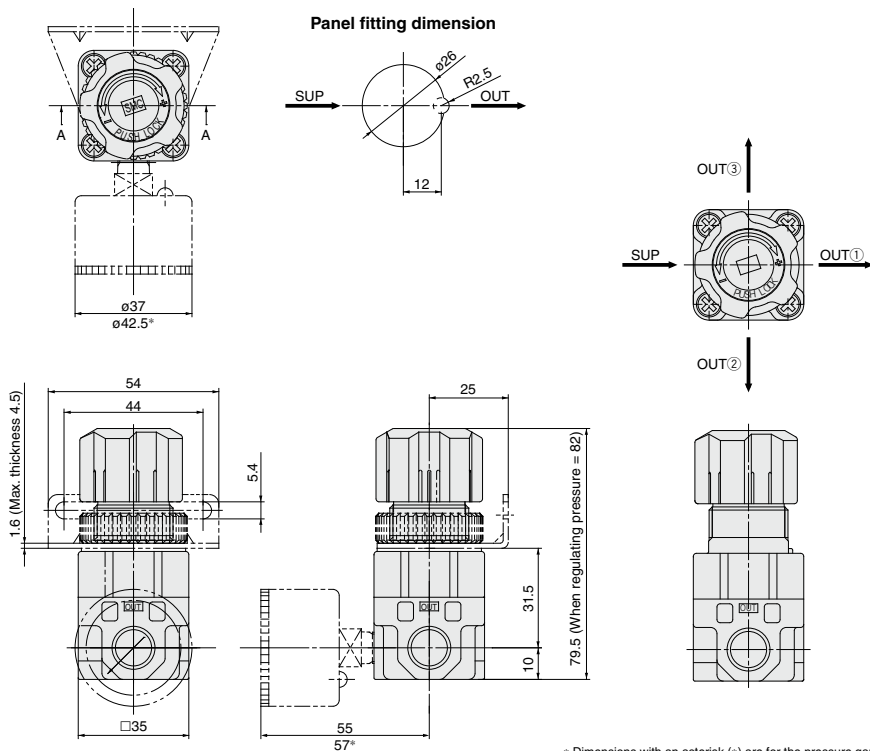

* Dimensions with an asterisk (*) are for the pressure gauge G46.

Option

Panel Nut

Part no.	1348110A
Material	POM, NBR (Gasket)

Dimensions

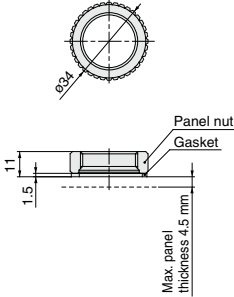

* Install the gasket underneath the panel and bracket (bonnet side).
Tighten the panel nut by hand without the use of tools.

Bracket

Part no.	1348112#1
Material	SPCC (Zinc chromated)

Dimensions

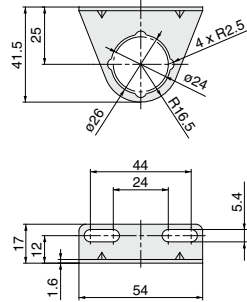

⚠ Precautions

Be sure to read this before handling the products.
Refer to back page 50 for Safety Instructions and pages 387 to 391 for Precautions on every series.

Design and Selection

⚠ Warning

- 1. Confirm the set pressure range.**
Be sure to install safety devices in locations where output pressure above the set pressure range could lead to damage or malfunction of equipment in the outlet side.
- 2. Residual pressure relief without inlet pressure.**
When the inlet pressure is relieved with the outlet pressure in a low pressure setting state, it may not be possible to eliminate the outlet pressure (residual pressure relief). Provide a residual pressure relief circuit when reliable elimination of the outlet pressure must be performed.

Mounting

⚠ Caution

- 1. To set the correct pressure**
1) Set the pressure by increasing from a lower pressure to the desired setting, and lock the knob after the pressure is set.
2) Make connections after confirming the "SUP" mark which indicates the air inlet. Reversed connections will cause malfunction.

ARJ

AR425
to 935

ARX

AMR

ARM

ARP

IR□-A

IR

IRV

VEX

SRH

SRP

SRF

ITV

IC

ITVH

ITVX

PVQ

VY1

VBA
VBAT

AP100