

Peltier-Type Chiller/Thermo-con

HEC Series

Air-cooled

Water-cooled

● Can precisely control the temperature of a heat source or process fluid.

Precisely control the temperature of the circulating fluid by using the Peltier device. Generates little vibration, and is refrigerant-free and environmentally friendly.

Can control the temperature of the heat source by using the external temperature sensor (sold separately). (Automatically adjusts to the effects of ambient temperature.)

- Temperature range setting:

10°C to 60°C

- Temperature stability:

±0.01°C to 0.03°C

Added cooling capacity of 140 W and 320 W (water-cooled), and 600 W (air-cooled).



140W: W184 x H262 x D321
320W: W184 x H262 x D321
230W: W210 x H393 x D436
600W: W240 x H390 x D455
1200W: W300 x H448 x D523

Air-cooled HEC-A Series

- Air-cooled: Can be used in the environments with no cooling equipment.
- Cooling capacity: 230 w, 600 w

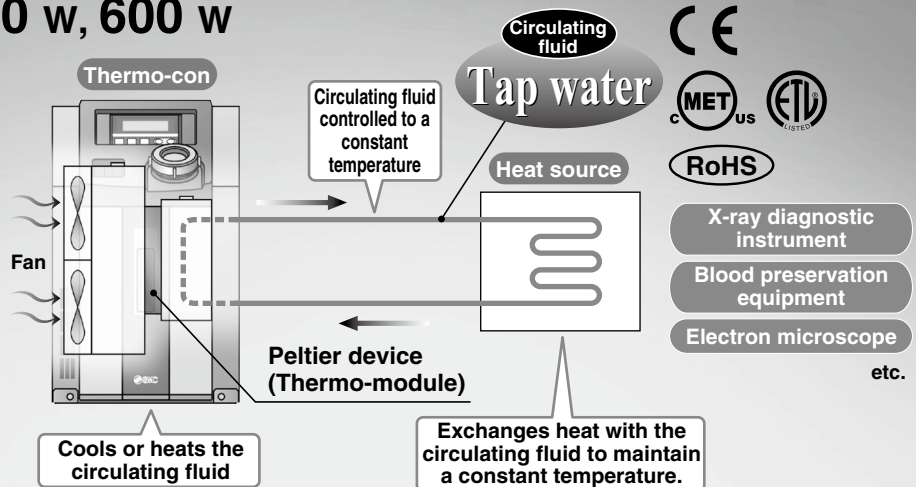

Water-cooled HEC-W Series

- Water-cooled: Can be used in the environments with facility water equipment.
- Cooling capacity: 140 w, 320 w, 600 w, 1200 w

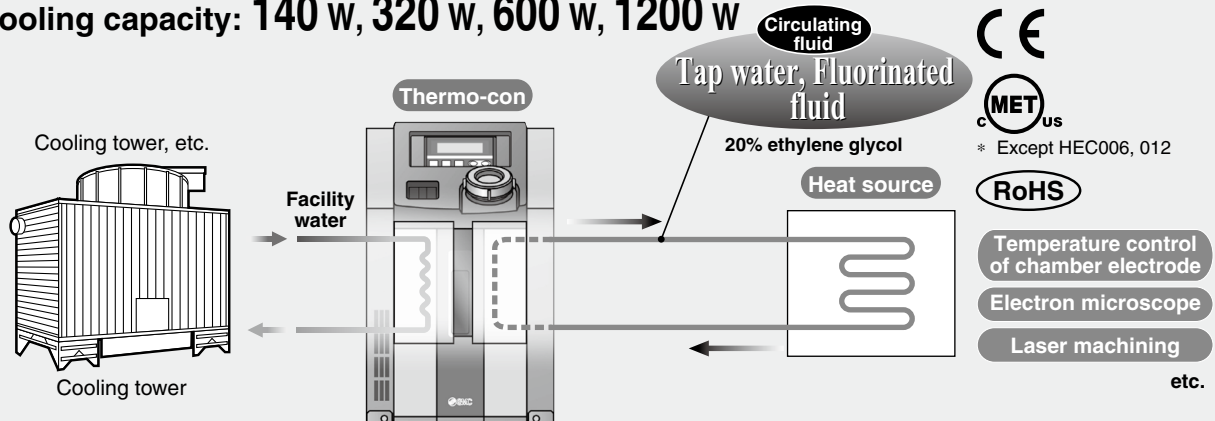

HRS

HRS-R

HRS090

HRS 100/150

HRS200

HRS090

HRSH

HRSE

HRR

HRL

HRZ

HRZD

HRW

HECR

HEC

HEB

HED

Technical Data

- **Power supply: Applicable to 100 v to 240 v**
(Air-cooled/**HEC-A series**, Water-cooled/**HEC001-W, HEC003-W**)
- **Suitable to fluorinated fluids (Fluorinert™ FC-3283, GALDEN® HT135)**
(Water-cooled/**HEC006-W, HEC012-W**)
- **Compatible with ethylene glycol 20% (Water-cooled/**HEC001-W, HEC003-W**)**

Learning Control Function (Temp. control by external temperature sensor)

This function adjusts the fluid temperature to the set value with an automatic offset setting. Set the external temperature sensor at the circulating fluid inlet located just in front of the heat source, which allows the Thermo-con to sample the fluid temperature. This function is effective when automatically adjusting for heat exhaust from piping, etc. If the external temperature sensor is installed directly on the heat source, the learning control function may not work properly due to large heat volume or large temperature difference. Be sure to install the sensor at the circulating fluid inlet.

Principle of Peltier Device (Thermo-module)

A Peltier device (thermo-module) is a plate type element, inside which P-type semiconductors and N-type semiconductors are located alternately. If direct current is supplied to the Peltier device (thermo-module), heat is transferred inside the device, and one face generates heat and increases temperature while the other face absorbs heat and decreases temperature. Therefore, changing the direction of the current supplied to the Peltier device (thermo-module) can achieve heating and cooling operation. This method has a fast response and can shift quickly between heating and cooling operation, so temperature can be controlled very precisely.

Air-cooled **HEC-A Series**

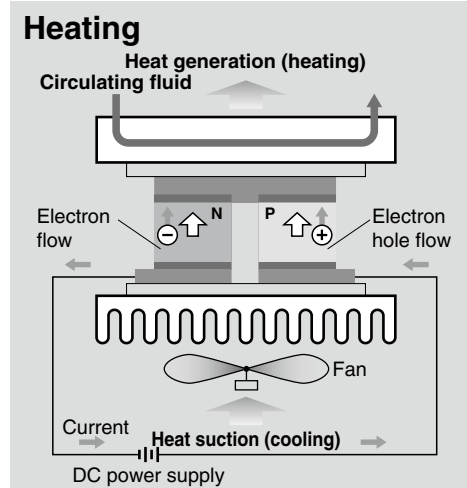
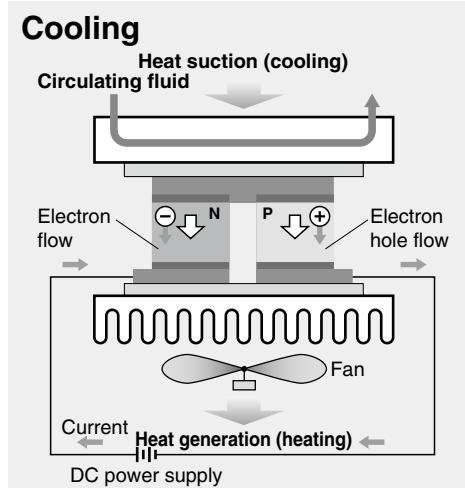

Water-cooled **HEC-W Series**

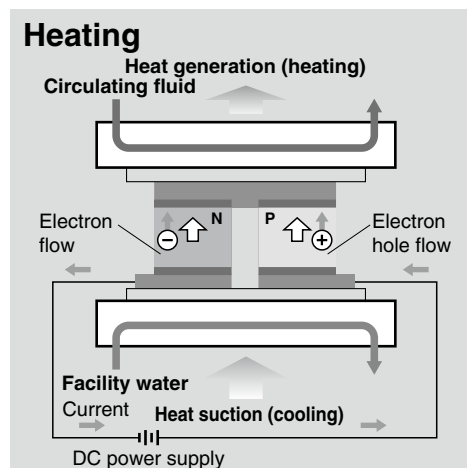
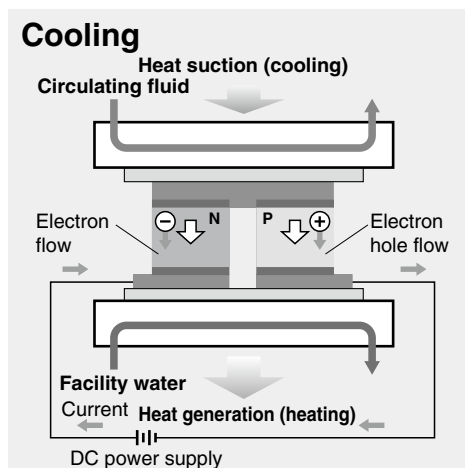

Construction and Principles

Air-cooled *HEC-A Series*



Figure 1

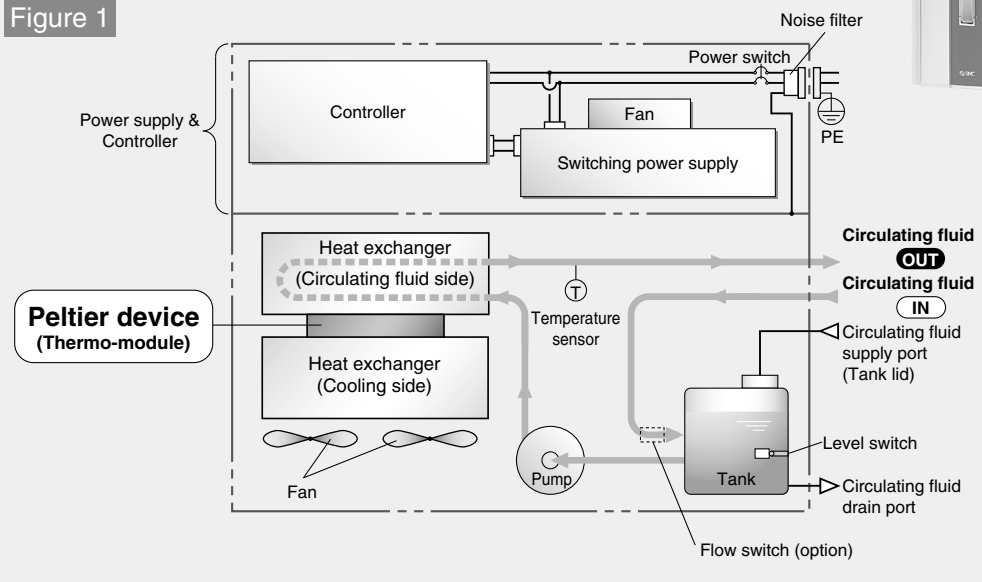

Water-cooled *HEC-W Series*



Figure 1

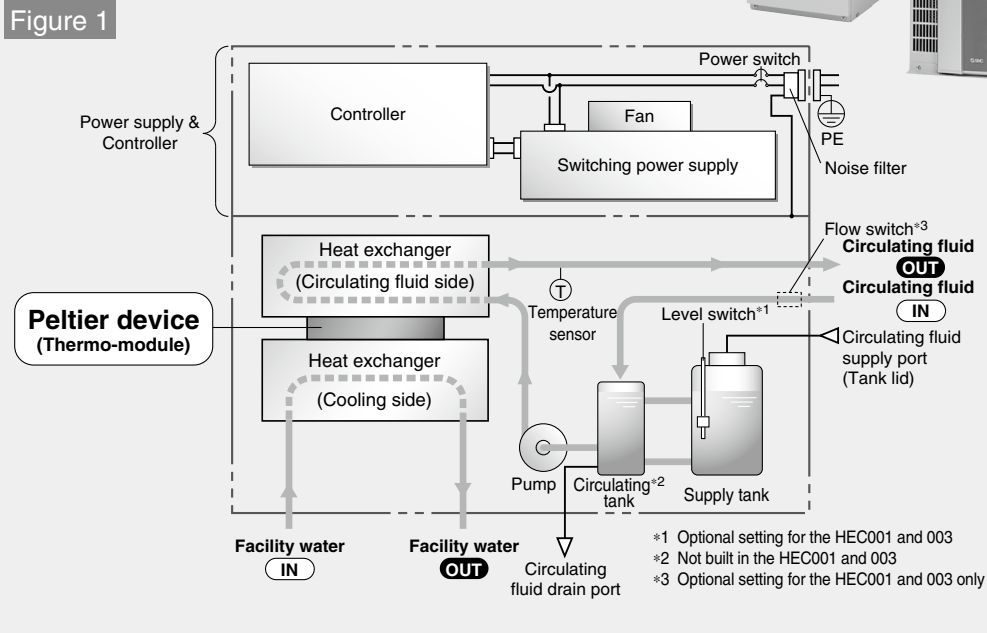
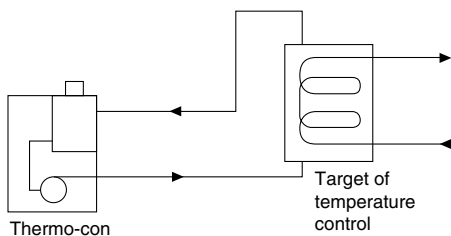

Figure 2 Example of circulating fluid piping



The thermo-con is constructed as shown in Figure 1. It interposes a Peltier device (thermo-module) between the heat exchangers for the circulating fluid and facility water and controls the pulse width of supply direct current to achieve the target outlet temperature of circulating fluid precisely.

The circulating fluid returns to the tank, and is transferred by the pump which is built in the thermo-con, and goes through the heat exchangers and internal sensors and out from the circulating fluid outlet.

Figure 2 shows an example of circulating fluid piping. The circulating fluid is transferred at a constant temperature by the pump.

HRS

HRS-R

HRS090

HRS 100/150

HRS200

HRS090

HRSH

HRSE

HRR

HRL

HRZ

HRZD

HRW

HECR

HEC

HEC

HEB

HED

Technical Data

When to Use Air-cooled and Water-cooled Thermo-con

Both air-cooled and water-cooled thermo-cons are available. Select a proper thermo-con by referring to the following.

Air-cooled

- No facility water equipment → Can install the unit easily without facility water equipment.
- Frequent piping changes → Can reduce the piping installation labor since facility water piping is not required.

Water-cooled

- Need to avoid effects of ambient temperature. → Since the unit is water-cooled, the ambient temperature will have little effect.
- Want to reduce the installation space. → Can reduce the space since the unit is compact.

Application Examples

Air-cooled
Water-cooled

Semiconductor

Example: Temperature control of a chamber electrode

- Etching equipment
- Spatter equipment
- Cleaning equipment
- Coating equipment
- Dicing equipment
- Tester, etc.

Air-cooled

Medical

Example: Blood preservation

- X-ray diagnostic instrument
- MRI
- Blood preservation equipment

Air-cooled
Water-cooled

Machine tool

Example: Laser machining

Temperature-controlling the laser generating tube enables the laser wavelength to be optimised, improving the accuracy of the machined cross sectional area.

- Wire cutting
- Grinder
- Spot welding
- Plasma welding
- Laser machining, etc.

Air-cooled
Water-cooled

Analysis

Example: Electronic microscope

Prevents the distortion caused by the heat generated by the electronic gun in an electronic microscope.

- Electron microscope
- X-ray analytical instrument
- Gas chromatography
- Sugar level analytical instrument, etc.

Bonding of DVD including next generation

Air-cooled

Water-cooled

Cooling of semiconductor laser

Air-cooled

Water-cooled

Temperature control of die-cast mold

Air-cooled

Water-cooled

CONTENTS

HEC Series



Model Selection Page 445

Thermo-con

Air-cooled HEC-A Series

How to Order/Specifications Page 447
 Cooling Capacity/Heating Capacity/
 Pump Capacity (Thermo-con Outlet) Page 448
 Parts Description Page 449
 Dimensions Page 450
 Connectors Page 452
 Alarm/Maintenance Page 453
 Options Page 454

Specific Product Precautions Page 455

Thermo-con

Water-cooled HEC-W Series

How to Order/Specifications Page 459
 Cooling Capacity/Heating Capacity/Pump Capacity
 (Thermo-con Outlet)/Pressure Loss in Facility Water Circuit ... Page 461
 Parts Description Page 464
 Dimensions Page 465
 Connectors Page 468
 Alarm/Maintenance Page 469
 Options Page 470

Specific Product Precautions Page 471

HRS

HRS-R

HRS090

HRS
100/150

HRS200

HRS090

HRS-H

HRS-E

HRR

HRL

HRZ

HRZD

HRW

HECR

HEC

HEB

HED

Technical
Data

HEC Series Model Selection

Guide to Model Selection

1. What radiation method will be used?

Without a cooling tower Air-cooled HEC-A series

With a cooling tower Water-cooled HEC-W series

When to Use Air-cooled and Water-cooled Thermo-con

<Air-cooled>

- No facility water equipment → Can install the unit easily without facility water equipment.
- Frequent piping changes → Can reduce the piping installation labor since facility water piping is not required.

<Water-cooled>

- Need to avoid effects of ambient temperature. → Since the unit is water-cooled, the ambient temperature will have little effect.
- Want to reduce installation space. → Can reduce the space since the unit is compact.

2. How much is the temperature in degrees centigrade for the circulating fluid?

Temperature range which can be set with the thermo-con: 10 to 60°C

If a lower temperature (down to -20°C) or higher temperature (up to 90°C) than this range is necessary, select the thermo-chiller HRZ series.

3. What kind of the circulating fluids will be used?

Circulating fluids that can be used in the thermo-con

Model	Tap water	Fluorinert™ FC-3238 GALDEN® HT135	20% ethylene glycol
HEC001-W, HEC003-W	○	Option	○
HEC006-W, HEC012-W	○	○	○
HEC002-A, HEC006-A	○	×	○

○ : Usable × : Unusable

4. How much cooling capacity required?

Allows a safety factor of 20% over the capacity that is actually required, taking into account the changes in the operating conditions. If a larger capacity than this thermo-con is necessary, select the thermo-cooler HRG series or thermo-chiller HRZ series.

Example 1 When the heat generation amount in the user's equipment is known.

Heat generation amount: 400 W

Cooling capacity = Considering a safety factor of 20%, $400 \times 1.2 = 480 \text{ W}$

Guide to Model Selection

Example 2 When the heat generation amount in the user's equipment is not known.

Obtain the temperature difference between inlet and outlet by circulating the fluid inside the user's equipment.

- Heat generation amount **Q** : Unknown
- Circulating fluid temperature difference $\Delta T (= T2 - T1)$: 0.8°C (0.8 K)
- Circulating fluid outlet temperature **T1** : 25°C (298.15 K)
- Circulating fluid return temperature **T2** : 25.8°C (298.95 K)
- Circulating fluid flow rate **L** : 3 L/min
- Circulating fluid : Water

$$Q = \frac{\Delta T \times L \times \gamma \times C}{60 \times 1000}$$

$$= \frac{0.8 \times 3 \times 1 \times 10^3 \times 4.2 \times 10^3}{60 \times 1000}$$

$$= 167 \text{ W}$$

Cooling capacity = Considering a safety factor of 20%,
 $167 \text{ W} \times 1.2 = \mathbf{200 \text{ W}}$

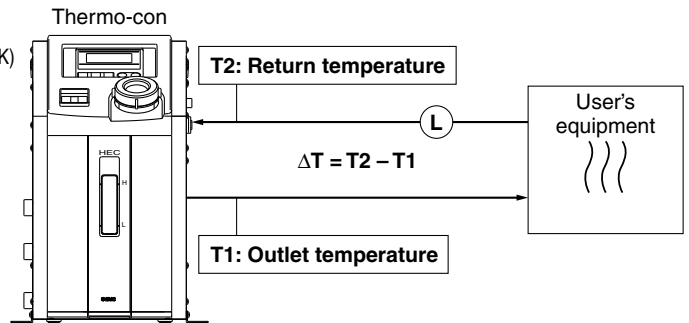

Example 3 When cooling the object below a certain temperature in certain period of time.

- Cooled substance total volume **V** : 20 L
- Cooling time **h** : 15 min
- Cooling temperature difference ΔT : Temperature difference: 10°C (10 K). Cool from 30°C (303 K) to 20°C (293 K).
- Circulating fluid : Tap water
- Density γ : 1 x 10³ kg/m³
- Specific heat **C**: 4.2 x 10³ J/(kg·K)

* Refer to the information shown below for the typical physical property values by circulating fluid.

$$Q = \frac{\Delta T \times V \times \gamma \times C}{h \times 60 \times 1000}$$

$$= \frac{10 \times 20 \times 1 \times 10^3 \times 4.2 \times 10^3}{15 \times 60 \times 1000}$$

$$= 933 \text{ W}$$

Cooling capacity = Considering a safety factor of 20%,
 $933 \text{ W} \times 1.2 = \mathbf{1120 \text{ W}}$

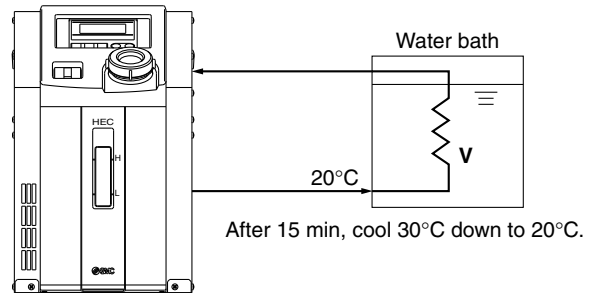

Precautions on Model Selection

The flow rate of the circulating fluid depends on the pressure loss of the user's equipment and the length, diameter and resistance created by bends in the circulating fluid piping, etc. Check if the required flow rate of circulating fluid can be obtained before selecting.

Circulating Fluid Typical Physical Property Values

Fluorinated Fluids

Physical property value	Density γ	Specific heat C
Temperature	[kg/m ³]	[J/(kg · K)]
-10°C	1.87 x 10 ³	0.87 x 10 ³
20°C	1.80 x 10 ³	0.96 x 10 ³
50°C	1.74 x 10 ³	1.05 x 10 ³
80°C	1.67 x 10 ³	1.14 x 10 ³

Water

Density γ : 1 x 10³ [kg/m³]

Specific heat **C**: 4.2 x 10³ [J/(kg · K)]

- HRS
- HRS-R
- HRS090
- HRS 100/150
- HRS200
- HRS090
- HRS
- HRS
- HRS
- HRR
- HRL
- HRZ
- HRZD
- HRW
- HECR
- HEC
- HEB
- HED
- Technical Data

Peltier-Type Chiller Thermo-con (Air-cooled)

HEC-A Series



How to Order

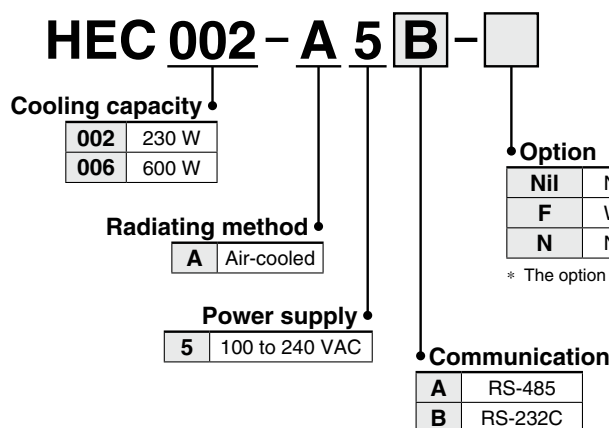

* The option should be specified when ordering.

* Select B when communication is not used.

Specifications (For details, please refer to our "Product Specifications" information.)

Model		HEC002-A5A	HEC002-A5B	HEC006-A5A	HEC006-A5B
Cooling method		Thermoelectric device (Thermo-module)			
Radiating method		Forced air cooling			
Control method		Cooling/Heating automatic shift PID control			
Ambient temperature/humidity		10 to 35°C, 35 to 80%RH (no condensation)			
Circulating fluid system	Circulating fluid	Tap water, 20% ethylene glycol aqueous solution			
	Operating temperature range	10.0 to 60.0°C (no condensation)			
	Cooling capacity	230 W*1		600 W*2	
	Heating capacity	600 W*1		900 W*2	
	Temperature stability*3	±0.01 to ±0.03°C			
	Pump capacity	Refer to performance chart.			
	Tank capacity	Approx. 1.2 L			
	Port size	IN/OUT	Rc1/4		Rc3/8
	Drain	Rc1/4 (with plug)			
Fluid contact material		Stainless steel 303, Stainless steel 304, EPDM, Ceramics, PPS glass 30%, Carbon, PE, Polyurethane			
Electrical system	Power supply	Single-phase 100 to 240 VAC ±10%, 50/60 Hz			
	Overcurrent protector	15 A			
	Current consumption	8 A (100 VAC) to 3 A (240 VAC)		10 A (100 VAC) to 4 A (240 VAC)	
	Alarm	Refer to alarm function.			
	Communications	RS-485	RS-232C	RS-485	RS-232C
Weight	Approx. 17.5 kg (including foot for fixing)		Approx. 27.5 kg (including foot for fixing)		
Accessories	Power cable, Foot for fixing				
Safety standards	CE marking, UL (NRTL) standards				

*1 Conditions: Set temperature 25°C, Ambient temperature 25°C, Circulating flow rate 3 L/min

*2 Conditions: Set temperature 25°C, Ambient temperature 20°C, Circulating flow rate 8 L/min

*3 The indicated values are with a stable load without turbulence in the operating conditions. It may be out of this range in some other operating conditions.

The values shown on the performance chart are not guaranteed, but typical. Allow margins for safety when selecting the model.

Cooling Capacity

HEC002

Circulating fluid: Tap water

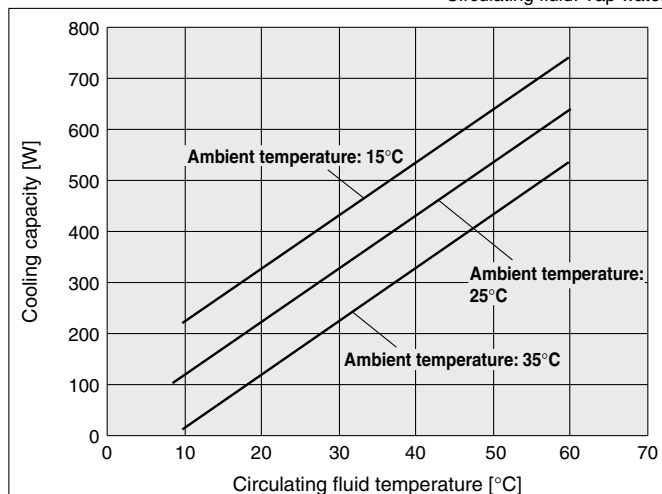

HEC006

Circulating fluid: Tap water

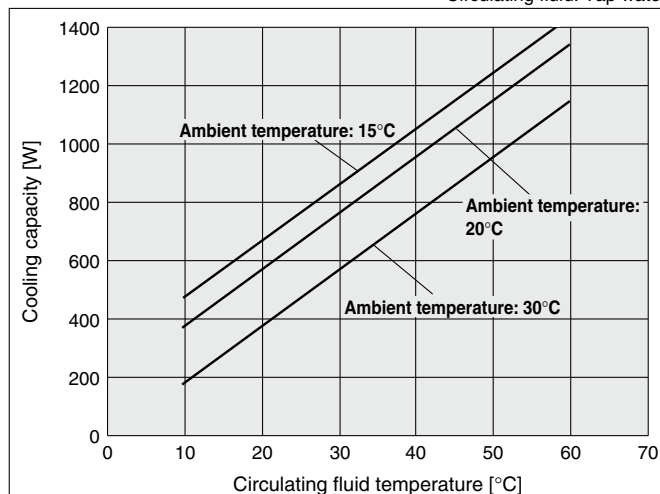

Heating Capacity

HEC002

Circulating fluid: Tap water

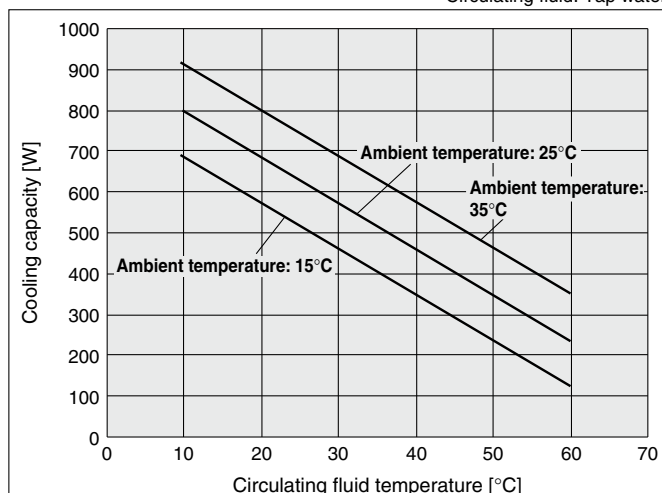

HEC006

Circulating fluid: Tap water

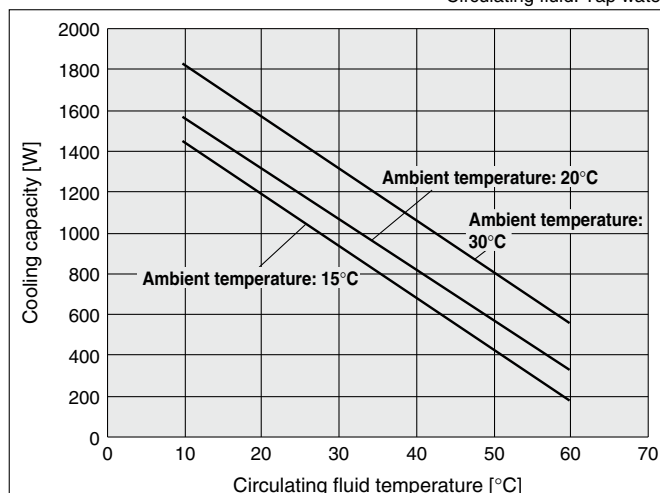

Pump Capacity (Thermo-con Outlet)

The pressure on the y-axis shows the discharge pressure of circulating fluid in the thermo-con.

HEC002

Circulating fluid: Tap water

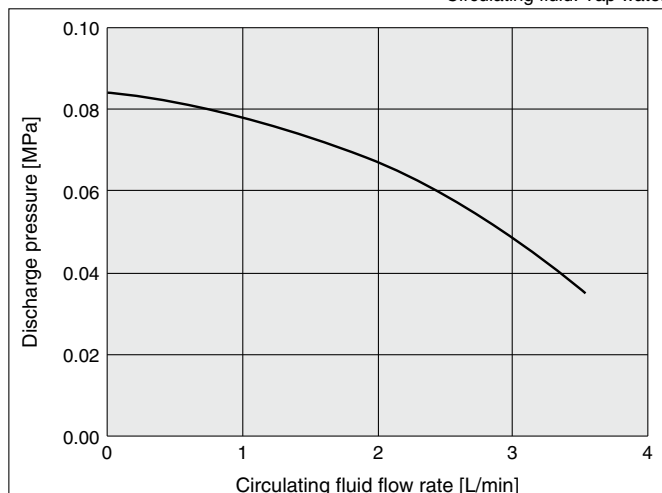

HEC006

Circulating fluid: Tap water

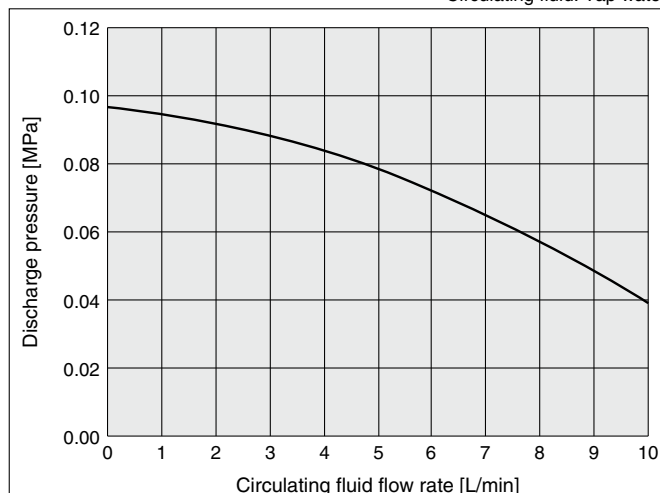

- HRS
- HRS-R
- HRS090
- HRS 100/150
- HRS200
- HRS090
- HRSH
- HRSE
- HRR
- HRL
- HRZ
- HRZD
- HRW
- HECR
- HEC
- HEB
- HED
- Technical Data

HEC-A Series

Parts Description

HEC002

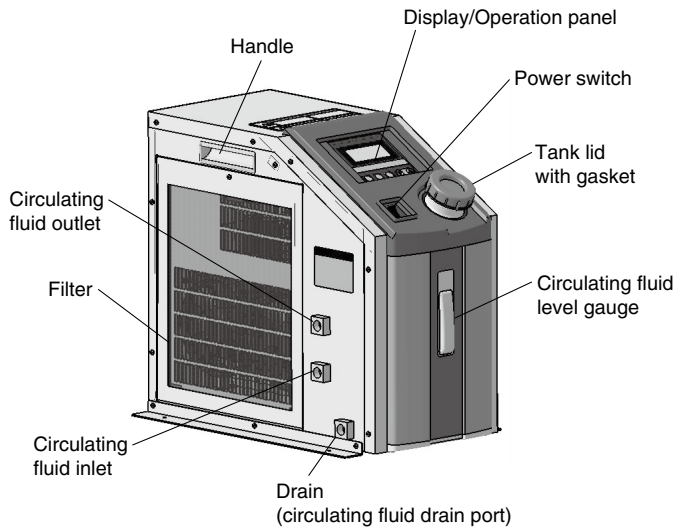
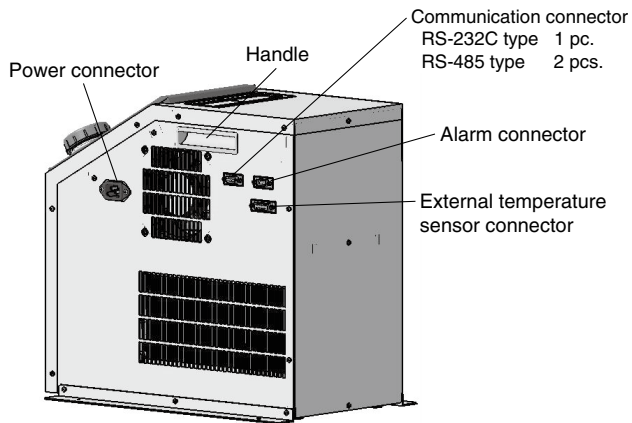

HEC006

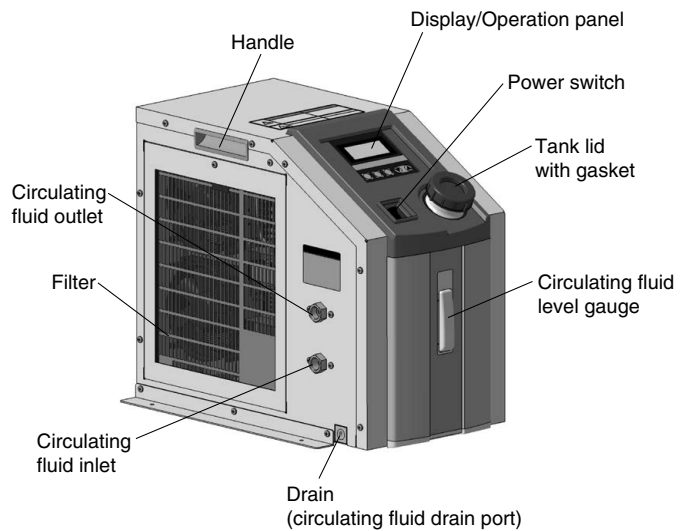
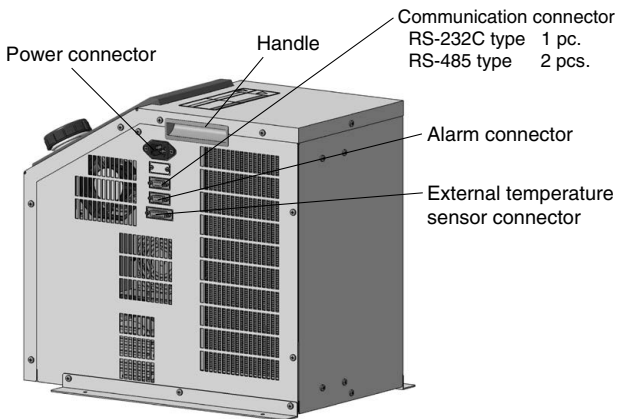

HEC-A Series

Dimensions

HEC006

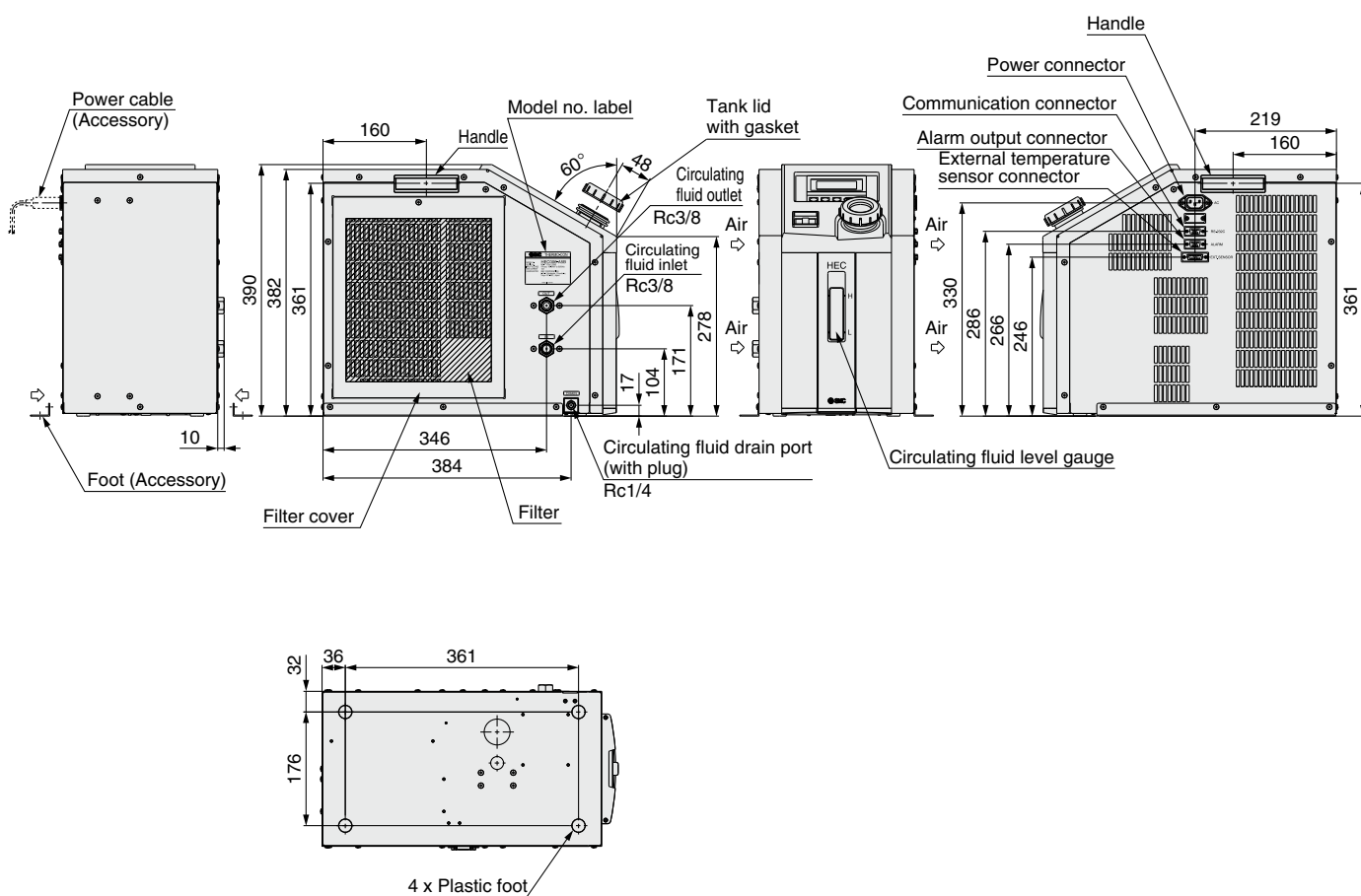
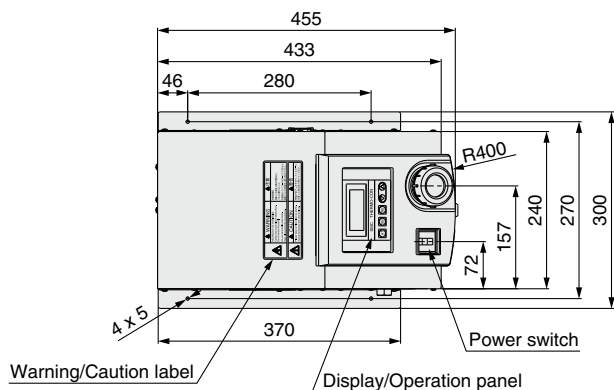

Option (Fitting part)

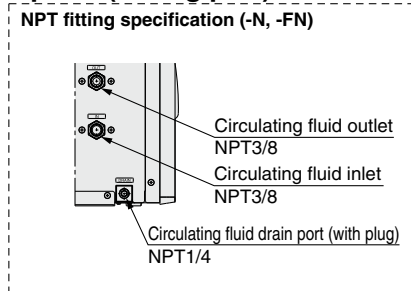

Power Cable (Accessory)

Connector: IEC 60320 C13 or equivalent
Cable: 14AWG, O.D. ø8.4

Wire color	Contents
Black	100 to 240 VAC
Black	100 to 240 VAC
Green/Yellow	PE

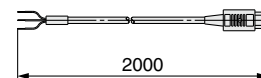

Connectors

1. Power connector (AC) IEC 60320 C14 or equivalent

Pin No.	Contents
1	100 to 240 VAC
2	100 to 240 VAC
3	PE

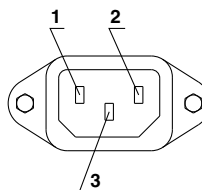

2. Communication connector (RS-232C or RS-485) D-sub 9 pin (socket) Holding screw: M2.6

Pin No.	Signal contents	
	RS-232C	RS-485
1	Unused	BUS+
2	RD	BUS-
3	SD	Unused
4	Unused	Unused
5	SG	SG
6-9	Unused	Unused

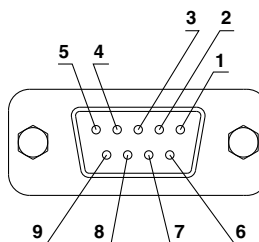

3. External sensor connector (EXT.SENSOR) D-sub 15 pin (socket) Holding screw: M2.6

Pin No.	Signal contents
1-2	Unused
3	Terminal A of resistance temperature detector
4	Terminal B of resistance temperature detector
5	Terminal B of resistance temperature detector
6-14	Unused
15	FG

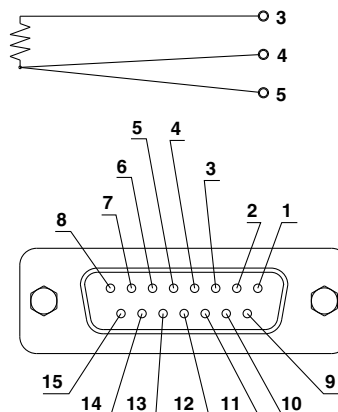

4. Alarm output connector (ALARM) D-sub 9 pin (pin) Holding screw: M2.6

Pin No.	Signal contents
1	Contact a for output cut-off alarm (open when alarm occurs)
2	Common for output cut-off alarm
3	Contact b for output cut-off alarm (closed when alarm occurs)
4-5	Unused
6	Contact a for upper/lower temp. limit alarm (open when alarm occurs)
7	Common for upper/lower temp. limit alarm
8	Contact b for upper/lower temp. limit alarm (closed when alarm occurs)
9	Unused

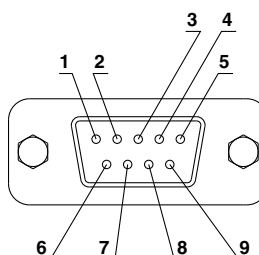

HRS

HRS-R

HRS090

HRS 100/150

HRS200

HRS090

HRS

HRS

HRS

HRS

HRS

HRS

HRS

HRS

HRS

HRS

HRS

Technical Data

HEC-A Series

Alarm

This unit is equipped as standard with a function allowing 15 kinds of alarms to display on the LCD and can be read out by serial communication. Also, it can generate relay output for upper/lower temperature limit alarm and output cut-off alarm.

Alarm

Alarm code	Alarm description	Operation status	Main reason
WRN	Upper/Lower temp. limit alarm	Continue	The temperature has exceeded the upper or lower limit of the target temperature.
ERR00	CPU hung-up	Stop	The CPU has crashed due to noise, etc.
ERR01	CPU check error	Stop	The contents of the CPU cannot be read out correctly when the power supply is turned on.
ERR03	Back-up data error	Stop	The contents of the back-up data cannot be read out correctly when the power supply is turned on.
ERR04	EEPROM writing error	Stop	The data cannot be written to EEPROM.
ERR11	DC power supply failure	Stop	The DC power supply has failed (due to fan stop or abnormal high temperature) or the thermo-module has been short-circuited.
ERR12	Internal temp. sensor high temp. error	Stop	The internal temperature sensor has exceeded the upper limit of cut-off temperature.
ERR13	Internal temp. sensor low temp. error	Stop	The internal temperature sensor has exceeded the lower limit of cut-off temperature.
ERR14	Thermostat alarm	Stop	The thermostat has been activated due to filter clog or fan/pump failure, etc.
ERR15	Abnormal output alarm	Continue	The temperature cannot be changed even at 100% output due to overload or disconnection of the thermo-module.
ERR16	Low flow rate alarm (option)	Stop	The flow rate of the circulating fluid has dropped.
ERR17	Internal temp. sensor disconnection alarm	Stop	The internal temperature sensor has been disconnected or short-circuited.
ERR18	External temp. sensor disconnection alarm	Continue	The external temperature sensor has been disconnected or short-circuited. (Only detected when in learning control or external tune control)
ERR19	Abnormal auto tuning alarm	Stop	Auto tuning has not been completed within 20 minutes.
ERR20	Low fluid level alarm	Stop	The amount of circulating fluid in the tank has dropped.

Maintenance

Maintenance of this unit is performed only in the form of return to and repair at SMC's site. As a rule, SMC will not conduct on-site maintenance. Separately, the following parts have a limited life and need to be replaced before the life ends.

Parts Life Expectation

Description	Expected life	Possible failure
Pump	3 to 5 years	The bearing is worn so the pump fails to transfer the circulating fluid, which results in temperature control failure.
Fan	5 to 10 years	The bearing uses up lubrication and makes the fan unable to supply enough air, which deteriorates the cooling and heating capacity.
DC power supply	5 to 10 years	The capacity of the electrolytic condenser decreases, and causes abnormal voltage which results in DC power supply failure and stops the thermo-con.
Display panel	50,000 hours (approx. 5 years)	The display turns off when the backlight of the LCD reaches the end of its life.

HEC-A Series Options

* Options have to be selected when ordering the thermo-con. It is not possible to add them after purchasing the unit.

F Option symbol With Flow Switch

HEC - - **F**

 ● With flow switch

This is an ON/OFF switch detecting low levels of the circulating fluid. When the fluid volume is 1 L/min. or less, "ERR16" is displayed and the thermo-con stops. This switch is installed between the circulating fluid inlet and the tank, and built into the thermo-con. Refer to page 442.

Type	Applicable model
Air-cooled	HEC002-A5 <input type="checkbox"/> -F
	HEC006-A5 <input type="checkbox"/> -F

N Option symbol NPT Thread

HEC - - **N**

 ● NPT thread

The connection parts of circulating fluid piping, facility water piping and circulating fluid drain port are NPT thread type.

Type	Applicable model
Air-cooled	HEC002-A5 <input type="checkbox"/> -N
	HEC006-A5 <input type="checkbox"/> -N

HRS

HRS-R

HRS090

HRS
100/150

HRS200

HRS090

HRSH

HRSE

HRR

HRL

HRZ

HRZD

HRW

HECR

HEC

HEB

HED

Technical
Data



HEC-A Series Specific Product Precautions 1

Be sure to read this before handling the products. Refer to page 513 for safety instructions and pages 514 to 517 for temperature control equipment precautions.

Design

Warning

1. This catalog shows the specifications of the Thermo-con.

1. Check detailed specifications in the separate "Product Specifications", and evaluate the compatibility of the thermo-con with user's system.
2. Although a protection circuit as a single unit is installed, the user is requested to carry out a safety design for the whole system.

Handling

Warning

1. Thoroughly read the operation manual.

Read the operation manual completely before operation, and keep the manual where it can be referred to as necessary.

2. If the set temperature is repeatedly changed by 10°C or more, the thermo-con may fail in short periods of time.

Operating Environment/Storage Environment

Warning

1. Keep within the specified ambient temperature and humidity range.

Also, if the set temperature is too low, condensation may form on the inside of the thermo-con or the surface of piping even within the specified ambient temperature range. Dew condensation can cause failure, and so must be avoided by considering operating conditions.

2. The thermo-con is not designed for clean room usage.

It generates dust from the pump inside the unit and the cooling fan.

3. Low molecular siloxane can damage the contact of the relay.

Use the thermo-con in a place free from low molecular siloxane.

Radiation Air

Caution

1. The inlet for radiation air must not be exposed to particles and dust as far as possible.
2. Do not let the inlet and outlet for radiation air get closed.

<HEC002>

If radiation is prevented, the set temperature may not be achieved depending on the value of the set temperature and the load. Keep a space of 100 mm for opened rear side or 200 mm for closed rear side respectively.

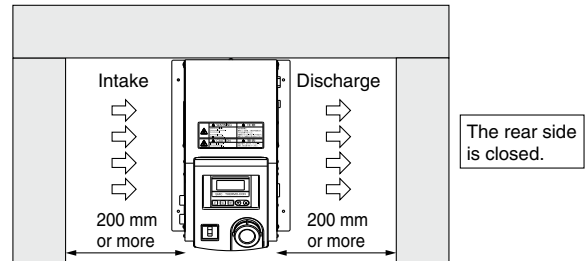
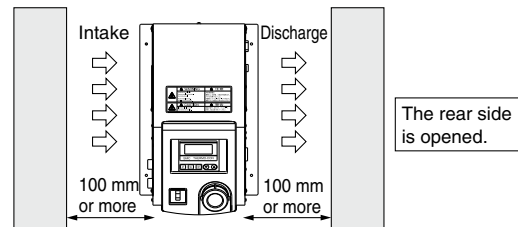

<HEC006>

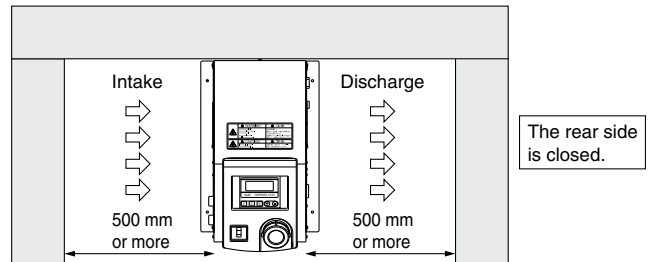
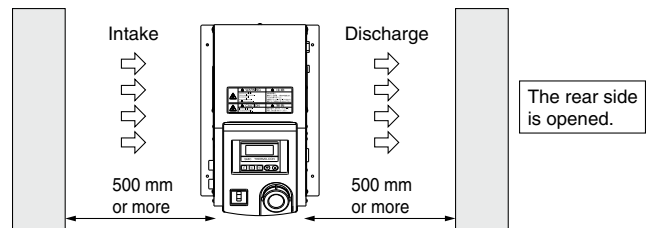

* The space must be 500 mm or more. Be sure that the ambient temperature is within the specification range.



HEC-A Series Specific Product Precautions 2

Be sure to read this before handling the products. Refer to page 513 for safety instructions and pages 514 to 517 for temperature control equipment precautions.

Radiation Air

⚠ Caution

- If more than one thermo-con is used, consider their arrangement so that the downstream sides of the thermo-cons suck radiation air from the upstream sides.

Otherwise, the performance at the downstream sides may deteriorate. Also, the set temperature may not be achieved depending on the value of the set temperature and the load. In such a case, take countermeasures such as changing the direction of the thermo-cons to prevent the deterioration of performance.

- If dust adheres to the filter, remove dust with a vacuum cleaner or a dry cloth.
- Do not operate without the filter.
Otherwise, dust may accumulate on the heat sink and electrical components, causing abnormal heating.

Circulating Fluid

⚠ Caution

- Use tap water or fluid which will not damage the wetted material.
(Stainless steel 303, Stainless steel 304, EPDM, Polypropylene, PE, PPE, Ceramics, Polyurethane)

- Deionized water (with an electric conductivity of approx. 1 μS/cm) can be used, but may lose its electric conductivity.
Also, if a facility supplying deionized water is used, the thermo-con may be damaged by static electricity.

- If deionized water is used, bacteria and algae may grow within a short period.
If the thermo-con is operated with bacteria and algae present, its cooling capacity or the capacity of the pump may deteriorate. Replace all deionized water regularly according to the conditions (once a month as a guide).

- If using a fluid other than water, please contact SMC beforehand.
- The maximum operating pressure of circulating fluid circuit is 0.1 MPa.
If this pressure is exceeded, leakage from the tank in the thermo-con may result.

- Select a pipe with a length and diameter which allows a flow rate of 1 L/min or more (HEC002) or 3 L/min or more (HEC006) for the circulating fluid.
If the flow rate is less than these values, the thermo-con will not be able to provide precise control, and the repeated cooling and heating operations may cause it to fail.

- A magnet driven pump is used as the circulating pump.
Fluids which contain metal powders such as iron powder cannot be used.

- The thermo-con must not be operated without circulating fluid.
The pump can break due to idling.

Circulating Fluid

⚠ Caution

- If the tank lid is opened after the supply of circulating fluid, the circulating fluid may spill out depending on the condition of the external piping.
- If an external tank is used, the circulating fluid may spill out from the internal tank lid depending on where the external tank is installed.
Check that the internal tank has no leakage if using an external tank.

- If there is a point where fluid is released to atmosphere externally (tank or piping), minimize the piping resistance at the circulating fluid return side.

If the piping resistance is too large, the piping may be crushed or the built-in circulator tank may be deformed or cracked because the pressure in the piping for return will become negative. The built-in circulator tank is made of resin (PE). Therefore, the tank may be crushed if the pressure is negative. Special attention must be paid if the flow rate of the circulating fluid is high. To avoid a negative pressure of -0.02 MPa or below, the piping for return should be as thick and short as possible to minimize the piping resistance. It is also effective to restrict the flow rate of circulating fluid or remove the gasket of the internal tank for the release to atmosphere.

- Fluorinated fluid falls outside of the specifications.
If it is used in the thermo-con, static electricity will be generated by the flow of fluid. This static electricity may be discharged to the board of the thermo-con, causing damage, operation failure, or loss of data such as set temperatures. Also, as the specific gravity of the fluorinated fluid is 1.5 to 1.8 times that of water, the pump will be overloaded, which also causes fluorinated fluid to fall outside the specifications. Therefore, if fluorinated fluid is to be used, please contact SMC and we will introduce you to a suitable special product (water-cooled type).

- Avoid operation with cavitation or bubbles due to low fluid level in the tank. This may shorten the pump life.

- If tap water is used, it should satisfy the quality standards shown below.

Tap Water (as a Circulating Fluid) Quality Standards

The Japan Refrigeration and Air Conditioning Industry Association
JRA GL-02-1994 "Cooling water system - Circulating type - Supply water"

	Item	Unit	Standard value	Influence	
				Corrosion	Scale generation
Standard item	pH (at 25°C)	—	6.0 to 8.0	○	○
	Electric conductivity (25°C)	[μS/cm]	100*1 to 300*1	○	○
	Chloride ion (Cl ⁻)	[mg/L]	50 or less	○	
	Sulfuric acid ion (SO ₄ ²⁻)	[mg/L]	50 or less	○	
	Acid consumption amount (at pH4.8)	[mg/L]	50 or less		○
	Total hardness	[mg/L]	70 or less		○
	Calcium hardness (CaCO ₃)	[mg/L]	50 or less		○
	Ionic state silica (SiO ₂)	[mg/L]	30 or less		○
Reference item	Iron (Fe)	[mg/L]	0.3 or less	○	○
	Copper (Cu)	[mg/L]	0.1 or less	○	
	Sulfide ion (S ₂ ⁻)	[mg/L]	Should not be detected.	○	
	Ammonium ion (NH ₄ ⁺)	[mg/L]	0.1 or less	○	
	Residual chlorine (Cl)	[mg/L]	0.3 or less	○	
	Free carbon (CO ₂)	[mg/L]	4.0 or less	○	

*1 In the case of [MΩ·cm], it will be 0.003 to 0.01.
○: Factors that have an effect on corrosion or scale generation.
• Even if the water quality standards are met, complete prevention of corrosion is not guaranteed.

HRS
HRS-R
HRS090
HRS100/150
HRS200
HRS090
HRS
HRS
HRS
HRS
HRR
HRL
HRZ
HRZD
HRW
HECR
HEC
HEB
HED
Technical Data



HEC-A Series

Specific Product Precautions 3

Be sure to read this before handling the products. Refer to page 513 for safety instructions and pages 514 to 517 for temperature control equipment precautions.

Communication

Caution

1. The set value can be written to EEPROM, but only up to approx. 1 million times.

In particular, pay attention to how many of times the writing is performed using the communication function.

Maintenance

Warning

1. Prevention of electric shocks and fire

Do not operate the switch with wet hands. Also, do not operate the thermo-con when water is present on its exterior surface.

2. Action in the case of error

If any error such as an abnormal sound, smoke, or bad odor occurs, cut off the power at once, and stop supplying and conveying fluid. Please contact SMC or a sales distributor to repair the thermo-con.

3. Regular inspection

Check the following items at least once a month. The inspection must be done by an operator who has sufficient knowledge and experience.

- a) Check the displayed contents.
- b) Check the temperature, vibration level, and for abnormal sounds in the body of the thermo-con.
- c) Check the voltage and current of the power supply system.
- d) Check the circulating fluid for leakage, contamination, and the presence of foreign matter. Replace the fluid when necessary.
- e) Check the flow condition and temperature of the radiated air, and the filter.

Technical Data
HED
HEB
HEC
HECR
HRW
HRZD
HRZ
HRL
HRR
HRSE
HRSH
HRSH090
HR200
HRS 100/150
HRS090
HRS-R
HRS

Peltier-Type Chiller Thermo-con (Water-cooled) HEC-W Series



How to Order

140 W, 320 W

HEC 003 - W 5 B -

Cooling capacity

001	140 W
003	320 W

Radiating method

W	Water-cooled
---	--------------

Power supply

5	100 to 240 VAC
---	----------------

Option

Nil	None
F	With flow switch
N	NPT thread
L	With level switch

* The option should be specified when ordering.

Communication

A	RS-485
B	RS-232C

* Select B when communication is not used.



Specifications (For details, please refer to our "Product Specifications" information.)

Model	HEC001-W5A	HEC001-W5B	HEC003-W5A	HEC003-W5B	
Cooling method	Thermoelectric device (Thermo-module)				
Radiating method	Water-cooled				
Control method	Cooling/Heating automatic shift PID control				
Ambient temperature/humidity	10 to 35°C, 35 to 80%RH (no condensation)				
Circulating fluid system	Circulating fluid	Tap water, 20% ethylene glycol			
	Operating temp. range	10.0 to 60.0°C (no condensation)			
	Cooling capacity	140 W*1		320 W*1	
	Heating capacity	400 W*1		770 W*1	
	Temperature stability*2	±0.01 to 0.03°C			
	Pump capacity	Refer to performance chart.			
	Tank capacity	Approx. 1.2 L			
	Port size	IN/OUT: Rc3/8 Drain: Rc1/4 (with plug)			
Fluid contact material	PPE, PP glass 10%, Alumina ceramics, Carbon, EPDM, Stainless steel 303, Stainless steel 304, PE, PP, NBR				
Facility water system	Temperature range	10 to 35°C (no condensation)			
	Pressure range	Within 1 MPa			
	Required flow rate*3	3 to 7 L/min			
	Port size	IN/OUT: Rc3/8			
	Fluid contact material	Stainless steel 304			
Electrical system	Power supply	Single-phase 100 to 240 VAC ±10%, 50/60 Hz			
	Overcurrent protector	10 A			
	Current consumption	3.5 A (100 VAC) to 1.5 A (240 VAC)		5.5 A (100 VAC) to 2.5 A (240 VAC)	
	Alarm	Refer to alarm function.			
	Communications	RS-485	RS-232C	RS-485	RS-232C
	Weight	Approx. 12 kg		Approx. 13 kg	
Accessories	Power cable, Foot for fixing, Splashproof cover				
Safety standards	CE marking, UL (NRTL) standards, SEMI				

*1 Circulating fluid/Tap water conditions: Circulating fluid set temperature 20°C, Flow rate 5 L/min., Facility water temperature 20°C, Flow rate 5 L/min., Ambient temperature 25°C

*2 The indicated values are with a stable load without turbulence in the operating conditions. It may be out of this range in some other operating conditions.

*3 The flow rate beyond the proper range may deteriorate performance or generate noise, causing the piping to break.

Peltier-Type Chiller Thermo-con (Water-cooled) **HEC-W Series**

How to Order



600 W, 1200 W

HEC 012 - W 2 B -

• **Cooling capacity**

006	600 W
012	1200 W

• **Radiating method**

W	Water-cooled
---	--------------

• **Power supply**

2	200 to 220 VAC
---	----------------

• **Option**

Nil	None
N	NPT thread

* The option should be specified when ordering.

• **Communication**

A	RS-485
B	RS-232C

* Select B when communication is not used.

Specifications (For details, please refer to our "Product Specifications" information.)

Model	HEC006-W2A	HEC006-W2B	HEC012-W2A	HEC012-W2B	
Cooling method	Thermoelectric device (Thermo-module)				
Radiating method	Water-cooled				
Control method	Cooling/Heating automatic shift PID control				
Ambient temperature/humidity	10 to 35°C, 35 to 80%RH (no condensation)				
Circulating fluid system	Circulating fluid*1	Tap water, Fluorinated fluid (Fluorinert™ FC-3283, GALDEN® HT135)			
	Operating temperature range	10.0 to 60.0°C (no condensation)			
	Cooling capacity	600 W (Tap water), 400 W (Fluorinert™ FC-3283)*2		1200 W (Tap water), 800 W (Fluorinert™ FC-3283)*3	
	Heating capacity	900 W (Tap water), 600 W (Fluorinert™ FC-3283)*2		2200 W (Tap water), 1500 W (Fluorinert™ FC-3283)*3	
	Temperature stability*4	±0.01 to 0.03°C			
	Pump capacity	Refer to performance chart.			
	Tank capacity	Approx. 3 L		Approx. 5 L	
	Port size	IN/OUT: Rc3/8 Drain: Rc1/4 (with plug)		IN/OUT: Rc3/4 Drain: Rc1/4 (with plug)	
Fluid contact material	Stainless steel 303, Stainless steel 304, EPDM, Ceramics, PPS glass 30%, Carbon, PE, Polyurethane		Stainless steel 303, Stainless steel 304, EPDM, Ceramics, PP, PE, Polyurethane, SiC, PPS		
Facility water system	Temperature range	10 to 35°C (no condensation)			
	Pressure range	Within 1 MPa			
	Required flow rate*5	8 to 15 L/min		10 to 15 L/min	
	Port size	IN/OUT: Rc3/8		IN/OUT: Rc1/2	
	Fluid contact material	Stainless steel 303, Stainless steel 304			
Electrical system	Power supply	Single-phase 200 to 220 VAC ±10%, 50/60 Hz			
	Overcurrent protector	10 A		15 A	
	Current consumption	5 A		10 A	
	Alarm	Refer to alarm function.			
	Communications	RS-485	RS-232C	RS-485	RS-232C
Weight	Approx. 25 kg (including foot for fixing)		Approx. 40 kg (including foot for fixing)		
Accessories	Power cable, Foot for fixing				
Safety standards	CE marking				

*1 GALDEN® is a registered trademark, belonging to the Solvay Group or its corresponding owner. Fluorinert™ is a trademark of 3M. Regarding the fluid other than the above, please consult with SMC.

*2 Conditions: Set temperature 25°C, Facility water temperature 20°C, Facility water flow rate 8 L/min, Ambient temperature 25°C.

*3 Conditions: Set temperature 25°C, Facility water temperature 20°C, Facility water flow rate 10 L/min, Ambient temperature 25°C.

*4 The indicated values are with a stable load without turbulence in the operating conditions. It may be out of this range in some other operating conditions.

*5 The flow rate beyond the proper range may deteriorate performance or generate noise, causing the piping to break.

HEC-W Series

The values shown on the performance chart are not guaranteed, but typical. Allow margins for safety when selecting the model.

Cooling Capacity

HEC001

Circulating fluid: Tap water

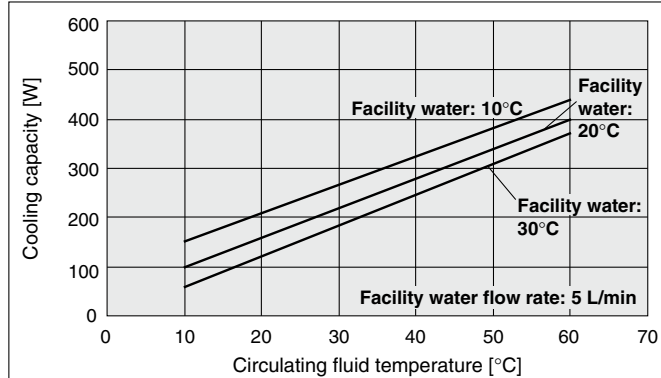

Circulating fluid: 20% ethylene glycol

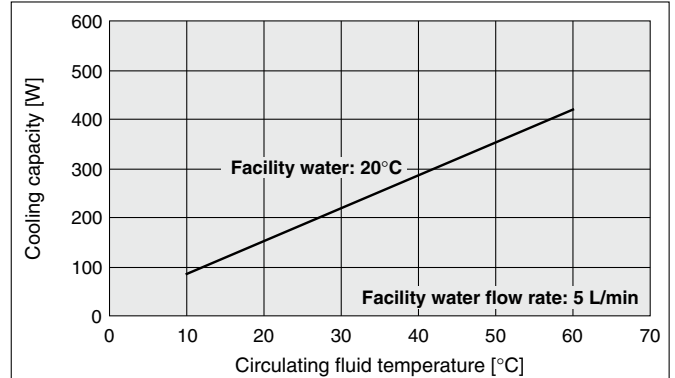

HEC003

Circulating fluid: Tap water

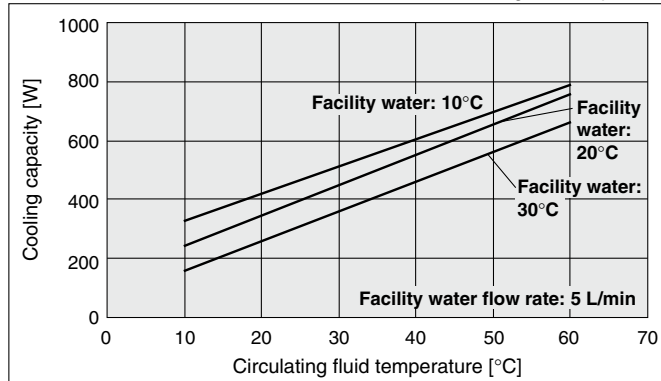

Circulating fluid: 20% ethylene glycol

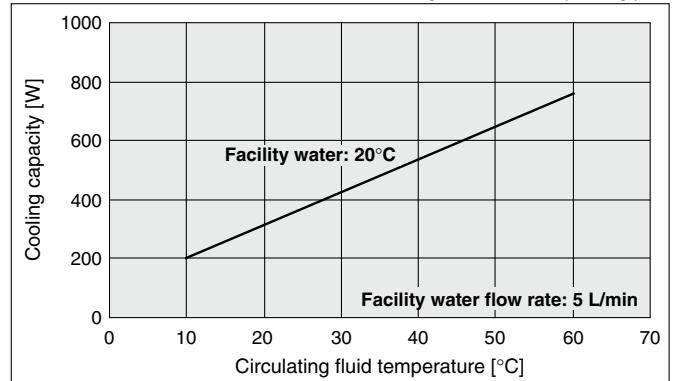

HEC006

Circulating fluid: Tap water

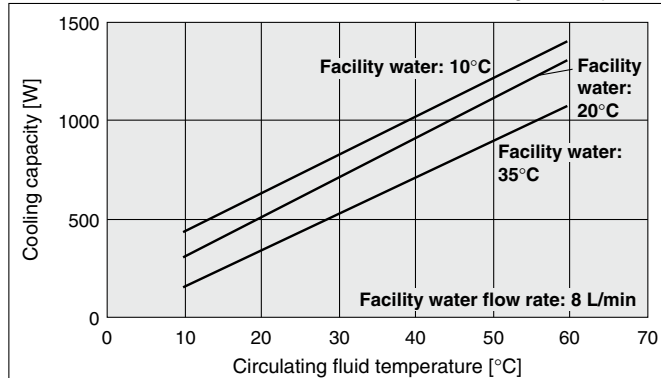

Circulating fluid: FC-3283

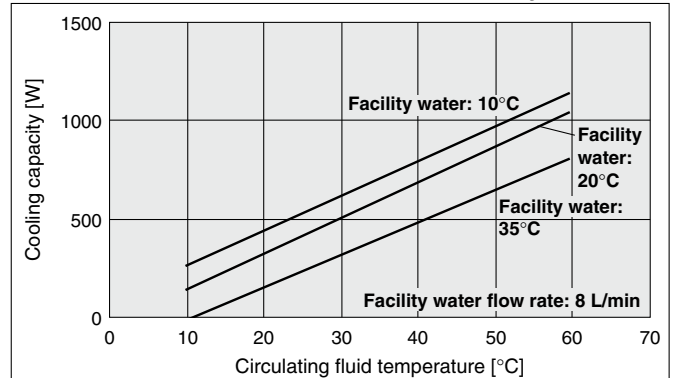

HEC012

Circulating fluid: Tap water

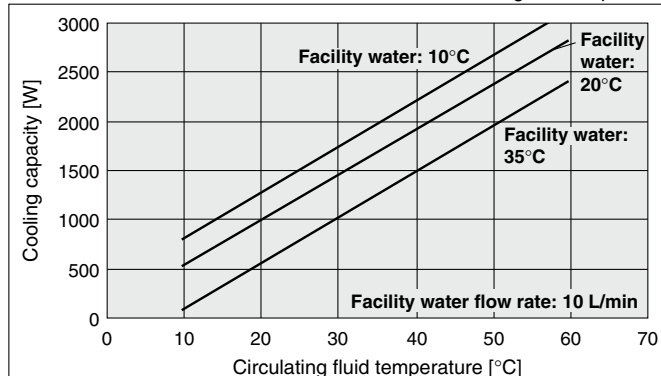

Circulating fluid: FC-3283

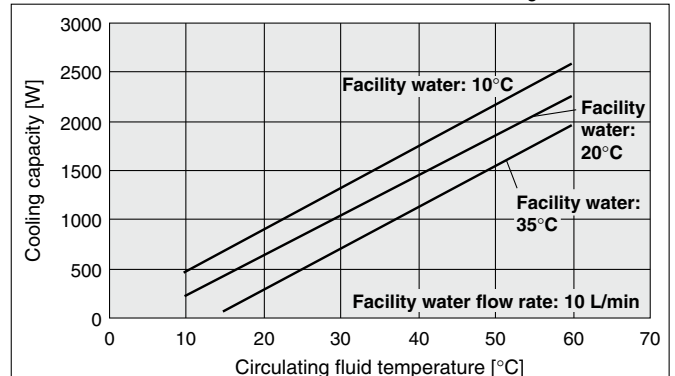

The values shown on the performance chart are not guaranteed, but typical. Allow margins for safety when selecting the model.

Heating Capacity

HEC001

Circulating fluid: Tap water

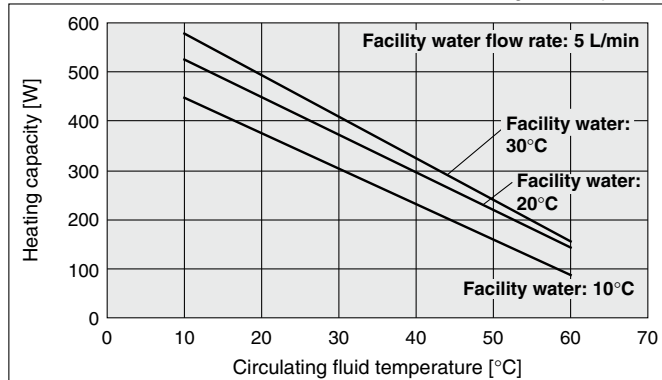

Circulating fluid: 20% ethylene glycol

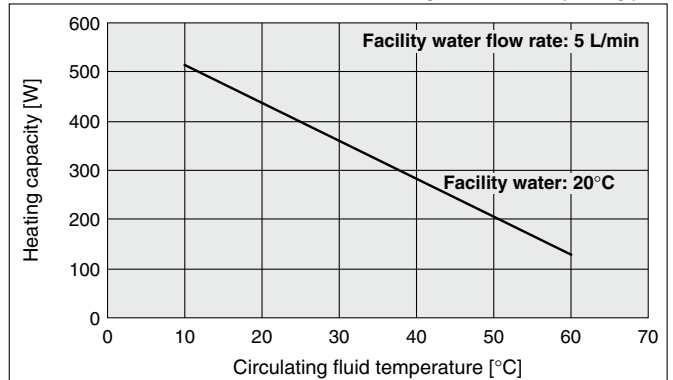

HEC003

Circulating fluid: Tap water

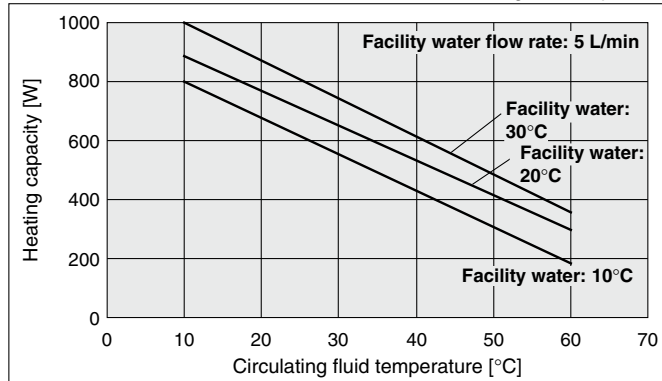

Circulating fluid: 20% ethylene glycol

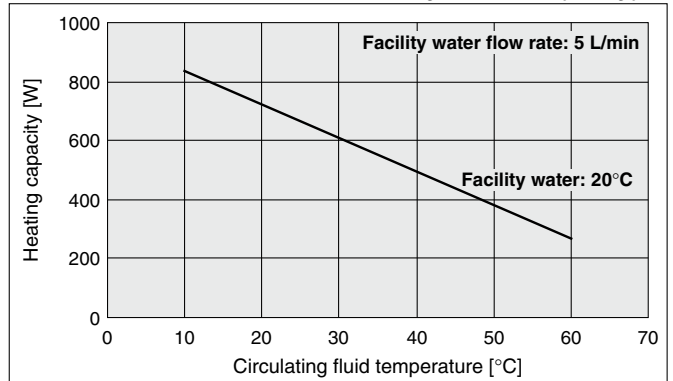

HEC006

Circulating fluid: Tap water

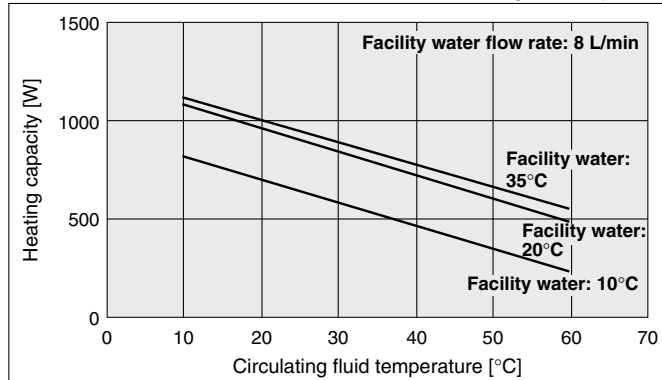

Circulating fluid: FC-3283

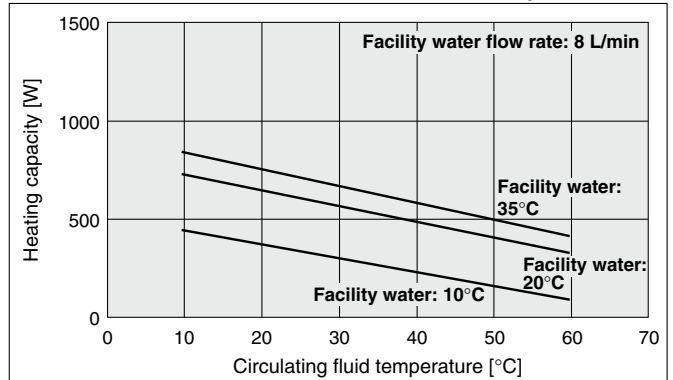

HEC012

Circulating fluid: Tap water

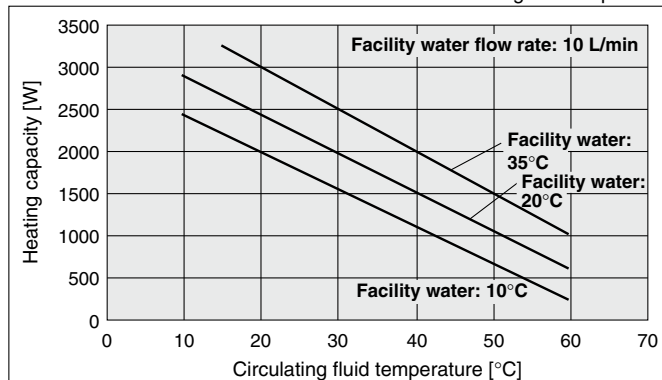

Circulating fluid: FC-3283

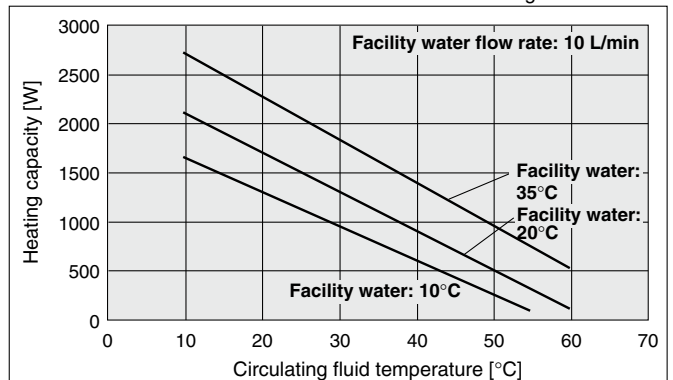

- HRS
- HRS-R
- HRS090
- HRS 100/150
- HRS200
- HRS090
- HRS
- HRS
- HRR
- HRL
- HRZ
- HRZD
- HRW
- HECR
- HEC
- HEB
- HED
- Technical Data

HEC-W Series

Pump Capacity (Thermo-con Outlet)

HEC001/003 Since a DC pump is used, the unit is not affected by power requirements.

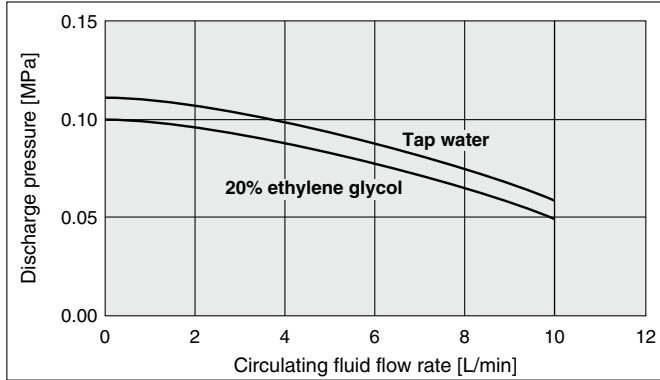

HEC006 Since a DC pump is used, the unit is not affected by power requirements.

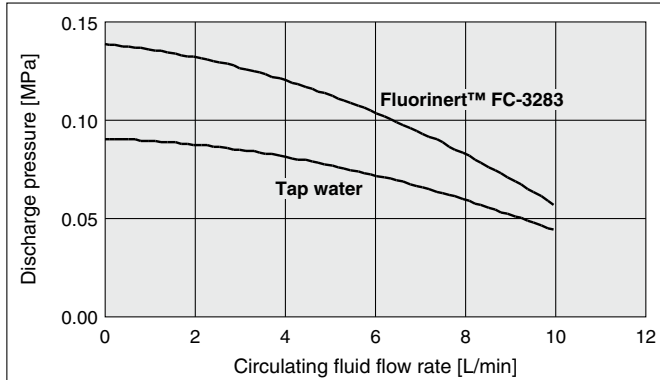

HEC012

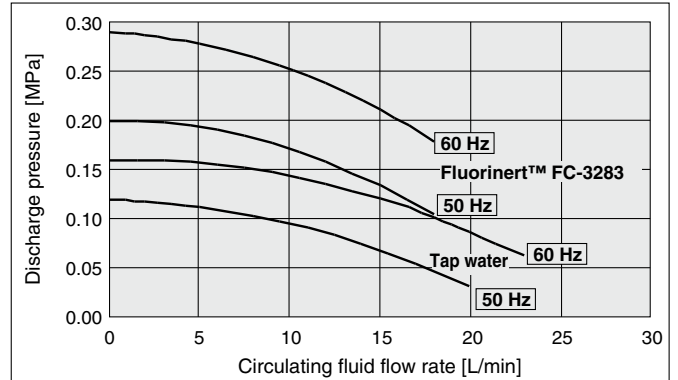

Pressure Loss in Facility Water Circuit

HEC001

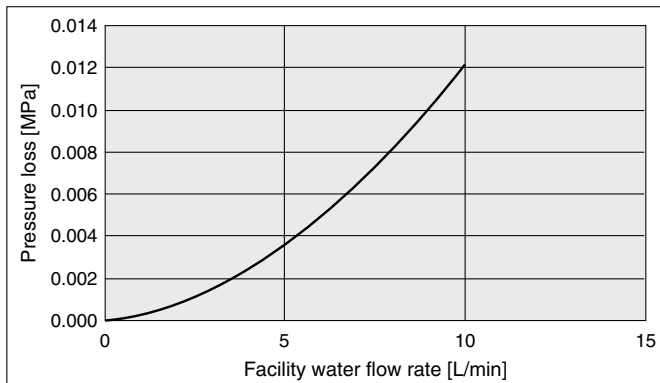

HEC003

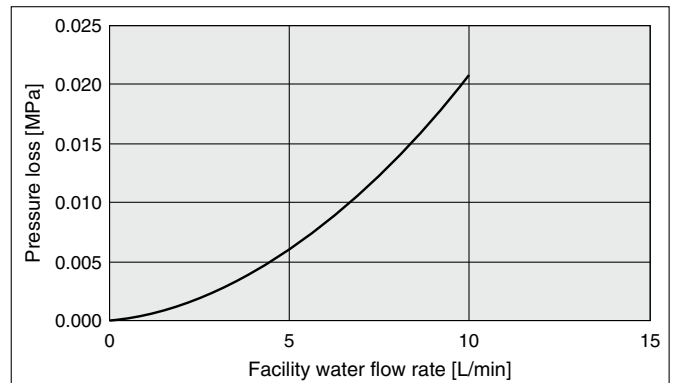

HEC006

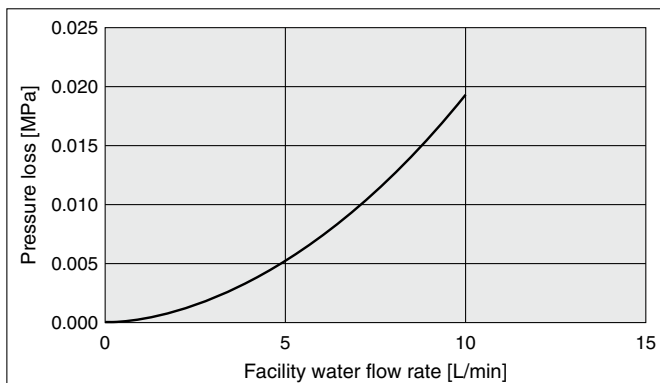

HEC012

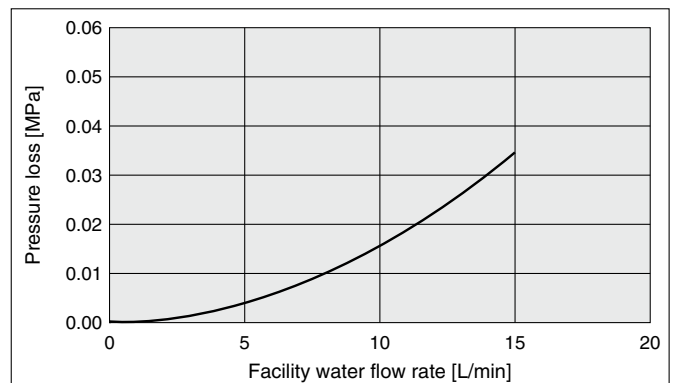

HEC-W Series

Dimensions

HEC001-W5□

HEC003-W5□

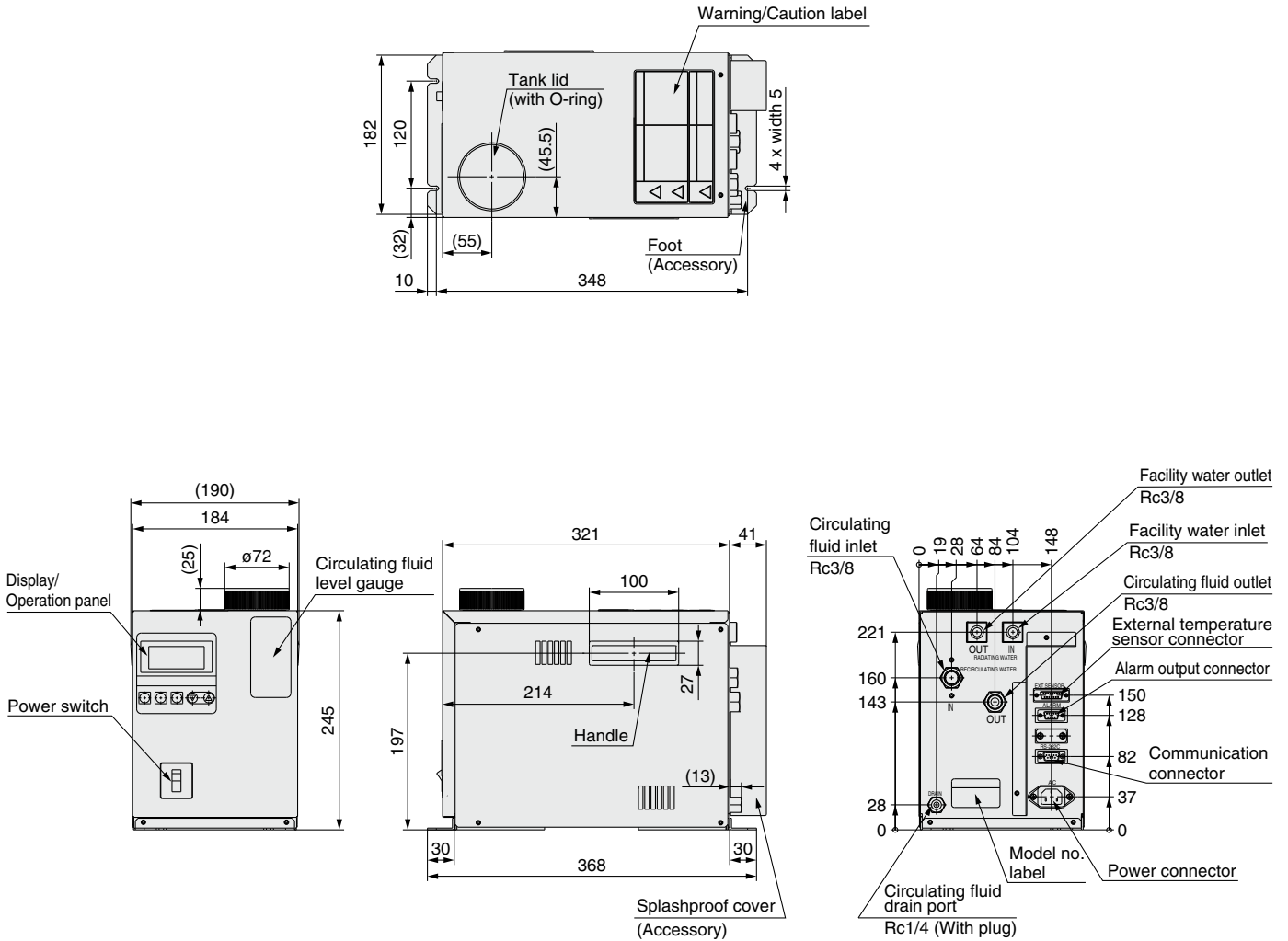

For NPT thread specification (-N), all fittings (including those at the circulating fluid drain port) are made of NPT.

Power Cable (Accessory)

Connector: IEC 60320 C13 or equivalent
Cable: 14AWG, O.D. ø8.4

Wire color	Contents
Black	100 to 240 VAC
Black	100 to 240 VAC
Green/Yellow	PE

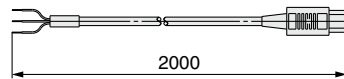

Power cable (Accessory)

Dimensions

HEC006-W2□

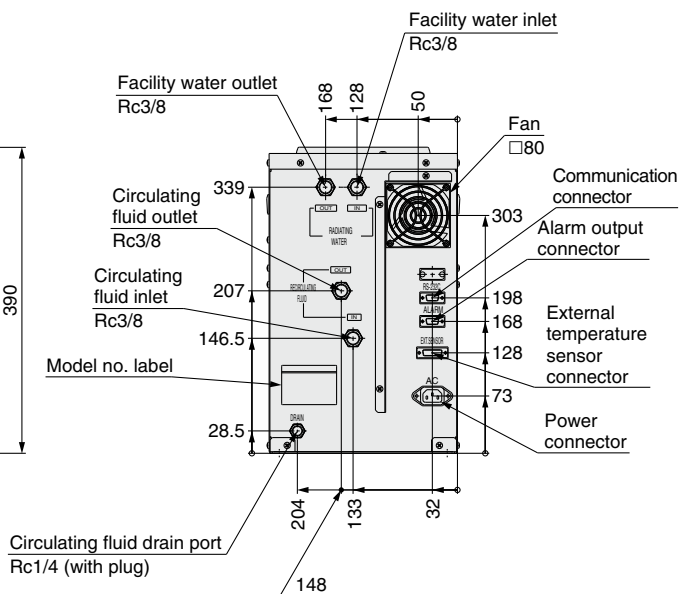
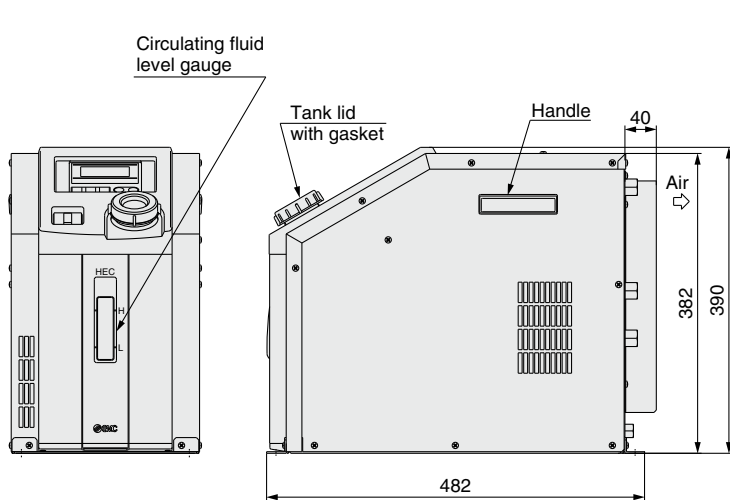
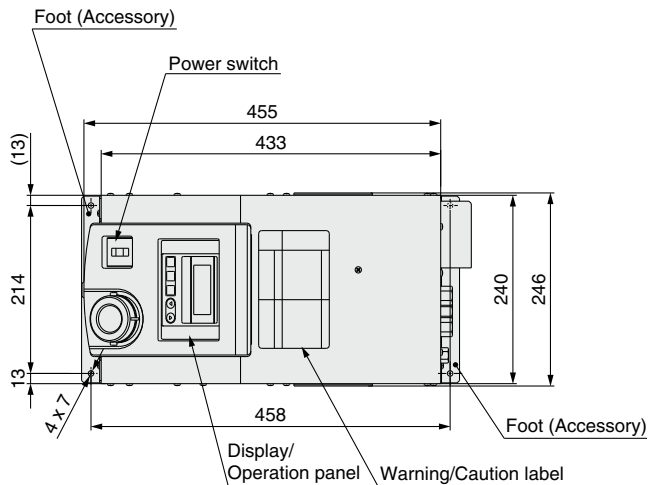

For NPT thread specification (-N), all fittings (including those at the circulating fluid drain port) are made of NPT.

Power Cable

Connector: IEC 60320 C13 or equivalent
Cable: 14AWG, O.D. ø8.4

Wire color	Contents
Black	200 to 220 VAC
Black	200 to 220 VAC
Green/Yellow	PE

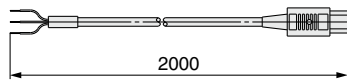

Power cable (Accessory)

HRS

HRS-R

HRS090

HRS
100/150

HRS200

HRS090

HRS

HRS

HRS

HRS

HRS

HRS

HRS

HRS

HRS

HRS

HRS

HRS

Technical
Data

HEC-W Series

Dimensions

HEC012-W2□

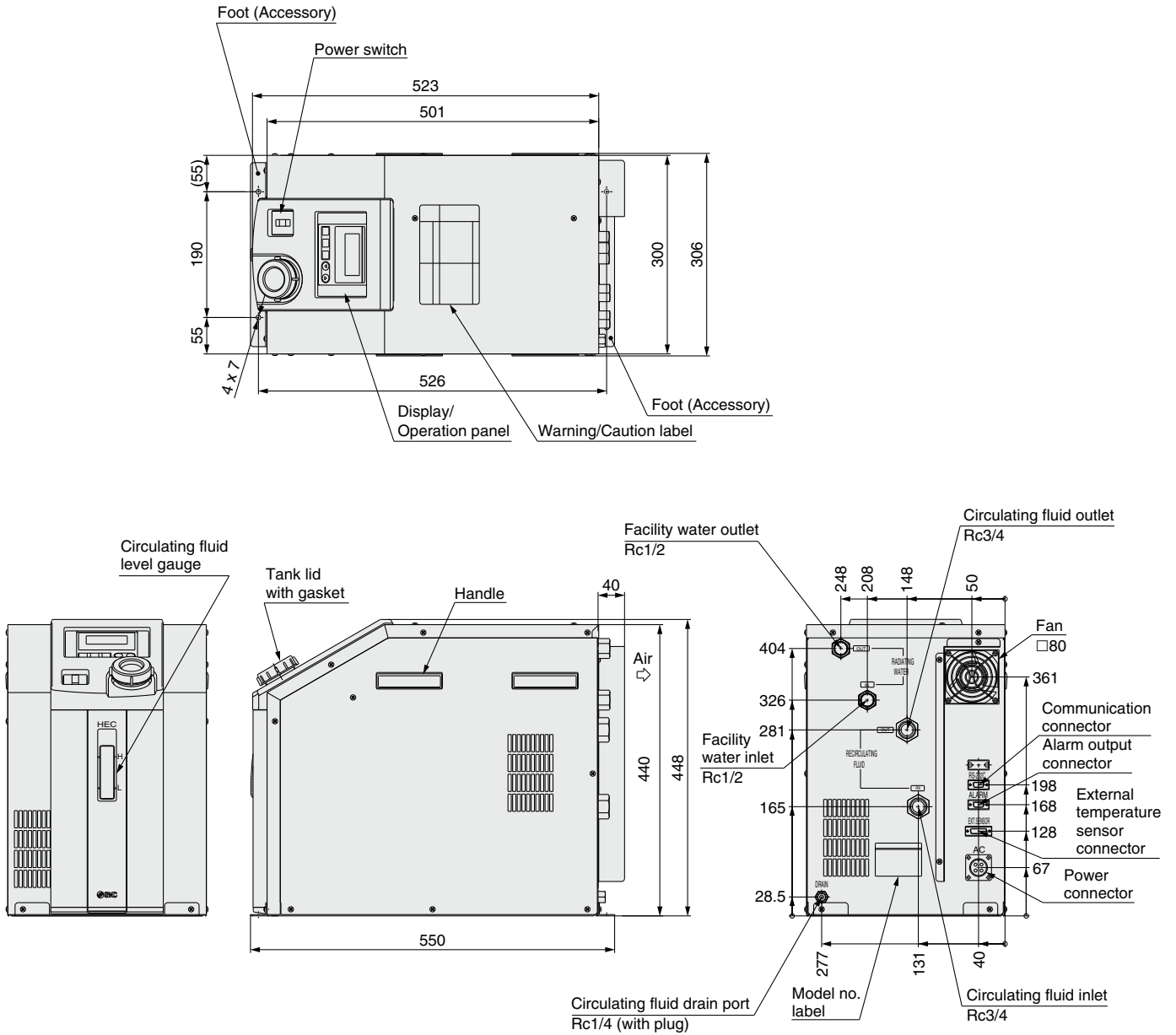

For NPT fitting specification (-N), all fittings (including those at the circulating fluid drain port) are made of NPT.

Power Cable

Connector: DDK CE05-6A18-10SD-D-BSS or equivalent

Cable: 14AWG, O.D. ø8.4

Wire color	Contents
Black	200 to 220 VAC
Black	200 to 220 VAC
Green/Yellow	PE

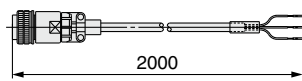

Power cable (Accessory)

Connectors

HEC006-W2□/001-W5□/003-W5□

1. Power connector (AC)

IEC 60320 C14 or equivalent
HEC006-W2□

Pin No.	Contents
1	200 to 220 VAC
2	200 to 220 VAC
3	PE

HEC001-W5□
HEC003-W5□

Pin No.	Contents
1	100 to 240 VAC
2	100 to 240 VAC
3	PE

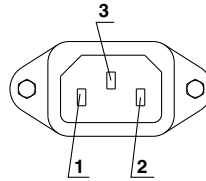

2. Communication connector (RS-232C or RS-485)

D-sub 9 pin (socket)
Holding screw: M2.6

Pin No.	Signal contents	
	RS-232C	RS-485
1	Unused	BUS+
2	RD	BUS-
3	SD	Unused
4	Unused	Unused
5	SG	SG
6-9	Unused	Unused

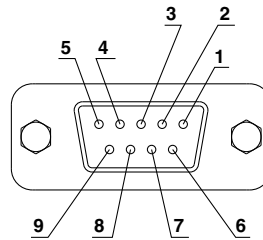

3. External sensor connector (EXT.SENSOR)

D-sub 15 pin (socket)
Holding screw: M2.6

Pin No.	Signal contents
1-2	Unused
3	Terminal A of resistance temperature detector
4	Terminal B of resistance temperature detector
5	Terminal B of resistance temperature detector
6-14	Unused
15	FG

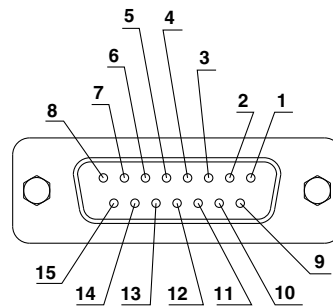

4. Alarm output connector (ALARM)

D-sub 9 pin (pin)
Holding screw: M2.6

Pin No.	Signal contents
1	Contact a for output cut-off alarm (open when alarm occurs)
2	Common for output cut-off alarm
3	Contact b for output cut-off alarm (closed when alarm occurs)
4-5	Unused
6	Contact a for upper/lower temp. limit alarm (open when alarm occurs)
7	Common for upper/lower temp. limit alarm
8	Contact b for upper/lower temp. limit alarm (closed when alarm occurs)
9	Unused

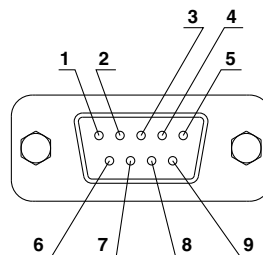

HEC012-W2□

Power connector (AC)

DDK CE05-2A18-10PD-D or equivalent

Pin No.	Contents
A	200 to 220 VAC
B	200 to 220 VAC
C	Unused
D	PE

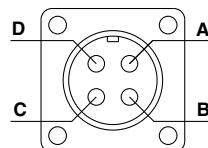

Other connectors are the same as those for the HEC006-W2□.

HEC-W Series

Alarm

This unit is equipped as standard with a function allowing 16 kinds of alarms to display on the LCD and can be read out by serial communication. Also, it can generate relay output for upper/lower temperature limit alarm and output cut-off alarm.

Alarm code	Alarm description	Operation status	Main reason
WRN	Upper/Lower temp. limit alarm	Continue	The temperature has exceeded the upper or lower limit of the target temperature.
ERR00	CPU hung-up	Stop	The CPU has crashed due to noise, etc.
ERR01	CPU check error	Stop	The contents of the CPU cannot be read out correctly when the power supply is turned on.
ERR03	Back-up data error	Stop	The contents of the back-up data cannot be read out correctly when the power supply is turned on.
ERR04	EEPROM writing error	Stop	The data cannot be written to EEPROM.
ERR05	EEPROM input over time error*4	Stop	The number of times of writing to EEPROM has exceeded 1 million times.
ERR11	DC power supply failure	Stop	The DC power supply has failed (due to abnormal high temperature) or an irregular voltage has occurred or the thermo-module has been short-circuited.
ERR12	Internal temp. sensor high temp. error	Stop	The internal temperature sensor has exceeded the upper limit of cut-off temperature.
ERR13	Internal temp. sensor low temp. error	Stop	The internal temperature sensor has exceeded the lower limit of cut-off temperature.
ERR14	Thermostat alarm	Stop	The thermostat has been activated due to insufficient of the facility water or high temperature.
ERR15	Abnormal output alarm	Continue	The temperature cannot be changed even at 100% output due to overload or disconnection of the thermo-module.
ERR16	Pump failure*1 or low circulating fluid level alarm*2	Stop	The pump has been overloaded*1 or the flow switch is activated*2.
ERR17	Internal temp. sensor disconnection alarm	Stop	The internal temperature sensor has been disconnected or short-circuited.
ERR18	External temp. sensor disconnection alarm	Continue	The external temperature sensor has been disconnected or short-circuited. (Only detected when in learning control or external tune control.)
ERR19	Abnormal auto tuning alarm	Stop	Auto tuning has not been completed within 20 minutes.
ERR20	Low fluid level alarm*3	Stop	The amount of circulating fluid in the tank has dropped and the level switch is activated.

*1 The HEC012 only

*2 Optional for the HEC001 and HEC003 only (Not available for the HEC006)

*3 Optional for the HEC001 and HEC003

*4 The HEC001 and HEC003 only

Maintenance

Maintenance of this unit is performed only in the form of return to and repair at SMC's site. As a rule, SMC will not conduct on-site maintenance. Separately, the following parts have a limited life and need to be replaced before the life ends.

Parts Life Expectation

Description	Expected life	Possible failure
Pump	3 to 5 years	The bearing is worn so the pump fails to transfer the circulating fluid, which results in temperature control failure.
Fan	5 to 10 years	The bearing uses up lubrication and makes the fan unable to supply enough air, which increases the internal temperature of the thermo-con, and activates the overheat protection of the power supply and generates the alarm.
DC power supply	5 to 10 years	The capacity of the electrolytic condenser decreases, and causes abnormal voltage which results in DC power supply failure and stops the thermo-con.
Display panel	50,000 hours (approx. 5 years)	The display turns off when the backlight of the LCD reaches the end of its life.

HEC-W Series Options

* Options have to be selected when ordering the thermo-con. It is not possible to add them after purchasing the unit.

F Option symbol With Flow Switch

HEC - - **F**

 ● With flow switch

This is an ON/OFF switch detecting low levels of the circulating fluid. When the fluid volume is 1 L/min. or less, "ERR16" is displayed and the thermo-con stops. This switch is installed between the circulating fluid inlet and the tank, and built into the Thermo-con. Refer to page 442.

Type	Applicable model
Water-cooled	HEC001-W5□-F
	HEC003-W5□-F

N Option symbol NPT Thread

HEC - - **N**

 ● NPT thread

The connection parts of circulating fluid piping, facility water piping and circulating fluid drain port are NPT thread type.

Type	Applicable model
Water-cooled	HEC001-W5□-N
	HEC003-W5□-N
	HEC006-W2□-N
	HEC012-W2□-N

L Option symbol With Level Switch

HEC - - **L**

 ● With level switch

This switch is used to detect a LOW level of tank fluid. When the fluid level becomes below the LOW level, "ERR20" is displayed and the thermo-con stops. This switch is installed in the circulating fluid tank and built into the thermo-con. Refer to page 442.

Type	Applicable model
Water-cooled	HEC001-W5□-L
	HEC003-W5□-L

Other models include a level switch as standard equipment.

HRS

HRS-R

HRS090

HRS
100/150

HRS200

HRS090

HRSH

HRSE

HRR

HRL

HRZ

HRZD

HRW

HECR

HEC

HEB

HED

Technical
Data



HEC-W Series

Specific Product Precautions 1

Be sure to read this before handling the products. Refer to page 513 for safety instructions and pages 514 to 517 for temperature control equipment precautions.

Design

Warning

- 1. This catalog shows the specifications of the thermo-con.**
 1. Check detailed specifications in the separate "Product Specifications", and evaluate the compatibility of the thermo-con with user's system.
 2. Although a protection circuit as a single unit is installed, the user is requested to carry out a safety design for the whole system.

Handling

Warning

- 1. Thoroughly read the operation manual.**
Read the operation manual completely before operation, and keep the manual where it can be referred to as necessary.
- 2. If the set temperature is repeatedly changed by 10°C or more, the thermo-con may fail in short periods of time.**

Operating Environment/Storage Environment

Warning

- 1. Keep within the specified ambient temperature and humidity range.**
Also, if the set temperature is too low, condensation may form on the inside of the thermo-con or the surface of piping even within the specified ambient temperature range. Dew condensation can cause failure, and so must be avoided by considering operating conditions.
- 2. The thermo-con is not designed for clean room usage.**
The pump and fan generate dust.
- 3. Low molecular siloxane can damage the contact of the relay.**
Use the thermo-con in a place free from low molecular siloxane.

Operating Environment/Storage Environment

Warning

4. Installation conditions

If the space for the intake and discharge of air is insufficient, the amount of transferred air will decrease, which can impair the performance and life of the product. Therefore, keep the conditions illustrated below for installation. Also, if ambient temperature is expected to be over 35°C, vent or exhaust air to prevent the increase of ambient temperature over 35°C.

<HEC006/012>

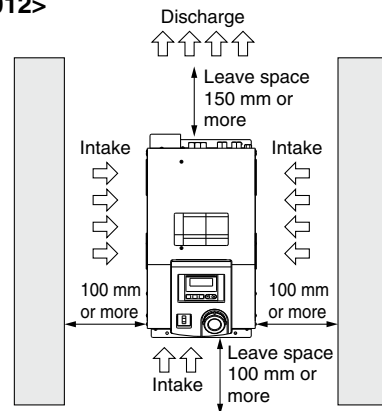

<HEC001/003>

It is not necessary to leave space for ventilation. Install the product while taking working space for installation and maintenance into account. However, ventilation must be also considered so that ambient temperature does not excessively rise.

Facility Water

Caution

- 1. If the temperature of the facility water is too low, it can cause formation of dew condensation inside the heat exchanger.**
Supply facility water with a temperature over the atmospheric dew point to avoid the formation of dew condensation.
- 2. If the facility water piping is connected to multiple machines, the facility water exchanges heat at the upstream side and its temperature will become higher as it goes downstream.**
Limit the number of connected thermo-cons to two per facility water system, and if more than two thermo-cons are to be connected, increase the number of systems.

Circulating Fluid

Caution

- 1. Use tap water or fluid which will not damage the wetted parts material as described in this catalog's specifications.**
(PPE, PP glass 10%, Alumina ceramics, Carbon, EPDM, Stainless steel 303, Stainless steel 304, PE, PP, NBR)
- 2. Deionized water (with an electric conductivity of approx. 1 μS/cm) can be used, but may lose its electric conductivity.**



HEC-W Series Specific Product Precautions 2

Be sure to read this before handling the products. Refer to page 513 for safety instructions and pages 514 to 517 for temperature control equipment precautions.

Circulating Fluid

⚠ Caution

3. If deionized water is used, bacteria and algae may grow within a short period.

If the thermo-con is operated with bacteria and algae present, its heat exchanging capacity or the capacity of the pump may deteriorate. Replace all deionized water regularly according to the conditions (once a month as a guide).

4. If using a fluid other than this catalog, please contact SMC beforehand.

5. The maximum operating pressure of circulating fluid circuit is 0.1 MPa.

If this pressure is exceeded, leakage from the tank in the thermo-con may result.

6. Select a pipe with a length and diameter which allows a flow rate of 3 L/min or more for the circulating fluid.

If the flow rate is less than these values, the thermo-con will not be able to provide precise control, and the repeated cooling and heating operations may cause it to fail.

7. A magnet driven pump is used as the circulating pump.

Fluids which contain metal powders such as iron powder cannot be used.

8. The thermo-con must not be operated without circulating fluid.

The pump can break due to idling.

9. If the tank lid is opened after the supply of circulating fluid, the circulating fluid may spill out depending on the condition of the external piping.

10. If an external tank is used, the circulating fluid may spill out from the internal tank lid depending on where the external tank is installed.

Check that the internal tank has no leakage if using an external tank.

11. If there is a point where fluid is released to atmosphere externally (tank or piping), minimize the piping resistance at the circulating fluid return side.

If the piping resistance is too large, the piping may be crushed or the built-in circulator tank may be deformed or cracked because the pressure in the piping for return will become negative. The built-in circulator tank is made of resin (PE). Therefore, the tank may be crushed if the pressure is negative. Special attention must be paid if the flow rate of the circulating fluid is high. To avoid a negative pressure of -0.02 MPa or below, the piping for return should be as thick and short as possible to minimize the piping resistance. It is also effective to restrict the flow rate of circulating fluid or remove the gasket of the internal tank for the release to atmosphere.

12. If fluorinated fluid is used in the thermo-con (HEC006/012), static electricity will be generated by the flow of fluid. This static electricity may be discharged to the board of the thermo-con, causing damage, operation failure, or loss of data such as set temperatures.

Ground pipe in order to remove static electricity.

13. Avoid operation with cavitation or bubbles due to low fluid level in the tank. This may shorten the pump life.

Circulating Fluid

⚠ Caution

14. If tap water is used, it should satisfy the quality standards shown below.

Tap Water (as a Circulating Fluid) Quality Standards

The Japan Refrigeration and Air Conditioning Industry Association
JRA GL-02-1994 "Cooling water system – Circulating type – Supply water"

	Item	Unit	Standard value	Influence	
				Corrosion	Scale generation
Standard item	pH (at 25°C)	—	6.0 to 8.0	○	○
	Electric conductivity (25°C)	[μS/cm]	100*1 to 300*1	○	○
	Chloride ion (Cl ⁻)	[mg/L]	50 or less	○	
	Sulfuric acid ion (SO ₄ ²⁻)	[mg/L]	50 or less	○	
	Acid consumption amount (at pH4.8)	[mg/L]	50 or less		○
	Total hardness	[mg/L]	70 or less		○
	Calcium hardness (CaCO ₃)	[mg/L]	50 or less		○
Reference item	Ionic state silica (SiO ₂)	[mg/L]	30 or less		○
	Iron (Fe)	[mg/L]	0.3 or less	○	○
	Copper (Cu)	[mg/L]	0.1 or less	○	
	Sulfide ion (S ₂ ⁻)	[mg/L]	Should not be detected.	○	
	Ammonium ion (NH ₄ ⁺)	[mg/L]	0.1 or less	○	
	Residual chlorine (Cl)	[mg/L]	0.3 or less	○	
	Free carbon (CO ₂)	[mg/L]	4.0 or less	○	

*1 In the case of [MΩ·cm], it will be 0.003 to 0.01.

○: Factors that have an effect on corrosion or scale generation.

• Even if the water quality standards are met, complete prevention of corrosion is not guaranteed.

Communication

⚠ Caution

1. The set value can be written to EEPROM, but only up to approx. 1 million times.

In particular, pay attention to how many of times the writing is performed using the communication function.

Maintenance

⚠ Warning

1. Prevention of electric shocks and fire

Do not operate the switch with wet hands. Also, do not operate the thermo-con when water is present on its exterior surface.

2. Action in the case of error

If any error such as an abnormal sound, smoke, or bad odor occurs, cut off the power at once, and stop supplying and conveying fluid. Please contact SMC or a sales distributor to repair the thermo-con.

3. Regular inspection

Check the following items at least once a month. The inspection must be done by an operator who has sufficient knowledge and experience.

- Check the displayed contents.
- Check the temperature, vibration level, and for abnormal sounds in the body of the thermo-con.
- Check the voltage and current of the power supply system.
- Check the circulating fluid for leakage, contamination, and the presence of foreign matter. Replace water when necessary.
- Check for leakage, quality change, flow rate and temperature of facility water.