

Bacteria Removal Filter

New

Hollow Fiber Element

RoHS

Captures bacteria in the compressed air

Bacteria Capture Performance

LRV ≥ 9

*1

- Use of FDA/Food Sanitation Law compliant materials^{*2}
- Use of NSF-H1 grade lubrication for flow path

*2 Parts in contact with fluid: Resin/Rubber

Designed for use in applications to HACCP principles and FSSC22000 standards

*1 LRV (Log Reduction Value): A mathematical representation of bacteria capture performance of filter element

Nominal filtration rating

0.01 μm

Filtering efficiency 99.99%

Initial pressure drop

0.03 MPa

Inlet pressure 0.7 MPa, at max. flow rate

Max. operating pressure

1.0 MPa

At 20°C

Flow rate

500

L/min (ANR)

Applications

- Blows air for opening packaging bags
- Blows air to ice cream lids and cups
- Fills rice bags with nitrogen (to prevent oxidation)



SFDA Series

SMC

CAT.ES120-7A

Bacteria Removal Filter Hollow Fiber Element

SFDA Series



How to Order

SFDA 2 0 3 - [] 02

Bacteria Removal Filter
(Bacteria removal performance LRV ≥ 9)

Symbol	Max. flow rate
2	500 L/min

Size

Case material

Symbol	Case material
3	Stainless steel

Port size

Symbol	Size
02	1/4
03	3/8

* The bracket is equipped as standard.
(Single unit: SFD-BR200)

Thread type

Symbol	Type
Nil	Rc
F	G
N	NPT

Relationship between Operating Temperature and Max. Operating Pressure

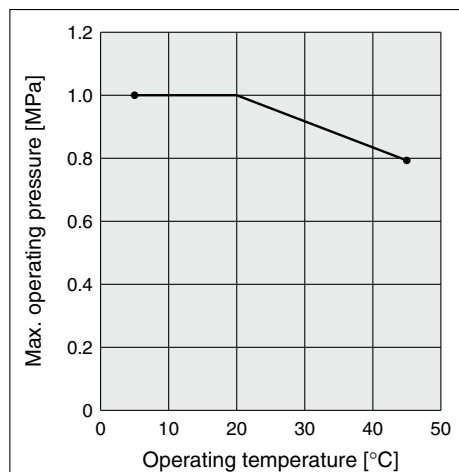

Specifications

Model		SFDA203
Port size	Rc1/4, NPT1/4, G1/4, Rc3/8, NPT3/8, G3/8	
Fluid	Air (Nitrogen)	
Rated flow	500 L/min (ANR)*1	
Nominal filtration rating*2	0.01 μm (99.99%)*5	
Operating pressure range*3	-100 kPa to 1.0 MPa (For nitrogen: 0.99 MPa)	
Operating temperature	5 to 45°C	
Initial pressure drop	0.03 MPa (Inlet pressure 0.7 MPa, at max. flow rate)	
Element proof differential pressure*4	0.5 MPa	
Proof pressure	1.5 MPa	
Element life	1 year, or when the pressure drop reaches 0.1 MPa	
Materials of parts in contact with fluid	Metal parts	Stainless steel
	Resin/Rubber parts	Materials compliant with FDA/Food Sanitation Law
	Lubrication oil	NSF-H1 grade
Weight	Port size 1/4	450 g
	Port size 3/8	430 g

*1 Maximum flow rate at inlet pressure 0.7 MPa and pressure drop 0.03 MPa

*2 Measured under SMC's specified conditions

*3 The maximum operating pressure varies depending on temperature. Refer to the graph that shows the relationship between the operating temperature and maximum operating pressure on the left.

*4 This means that the element does not break at 0.5 MPa. See "Specific Product Precautions."

*5 The bacteria removal filter is intended to filter solid particles. It is not suitable for the separation of water and oil.

Bacteria removal performance (bacteria capture performance of filter element) LRV ≥ 9

For example, this value indicates that 4 billion pieces of bacteria are reduced to 0 after passing through the filter. Refer to the equation below for details.

LRV (Log Reduction Value) indicates the bacteria capture performance.

$$LRV = \text{Log}_{10} \frac{A}{B} = \text{Log}_{10} \frac{4.7 \times 10^9}{1} = 9.7$$

A: Total number of test bacteria applied upstream of the filter
B: Total number of test bacteria after passing through the filter (downstream)

*1 When the number of bacteria contained in the filtrate is 0, substitute 1.

[Demonstrated by a third-party research institution (Test reference report No.: 2019D-BT-548)]

* This does not guarantee that all bacteria will be removed. Not for eliminating the virus. This is the data evaluated based on JIS K 3835.

Flow Rate Characteristics

SFDA203-02, -N03, -F03

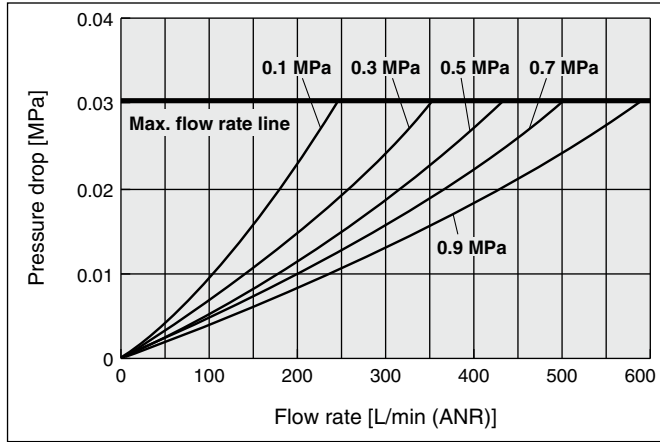

Construction

SFDA203-02/03

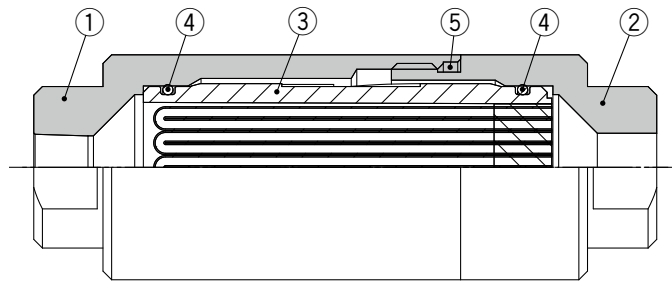

Component Parts

No.	Description	Material	Note
1	Case	Stainless steel	
2	Cover	Stainless steel	
3	Element	PC, Polyolefin, PU	
4	O-ring	FKM	
5	O-ring	FKM	

Replacement Parts

Description	Part no.	Set description
Element set	SFDA-EL200	③④⑤ (With 3 O-rings)
Bracket	SFD-BR200	Material: Stainless steel 304

Dimensions

SFDA203-02/03

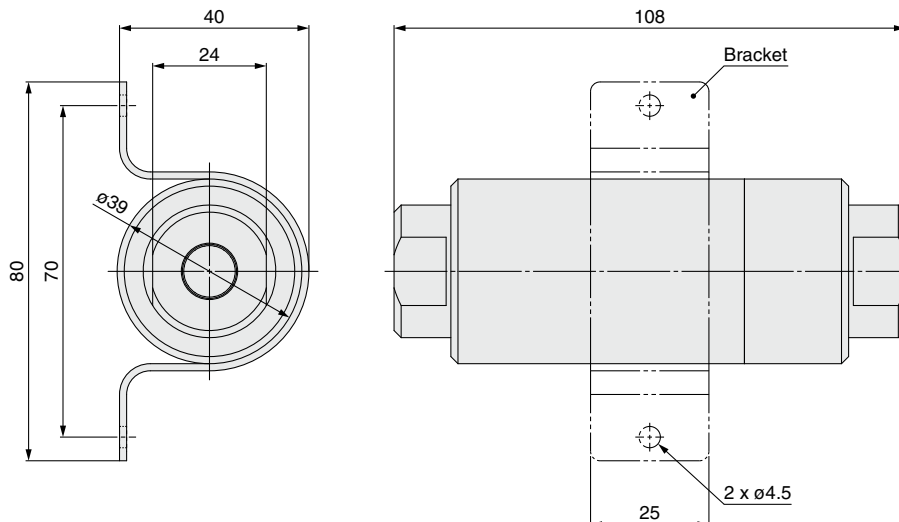



SFDA Series

Specific Product Precautions 1

Be sure to read this before handling the products. Refer to the back cover for safety instructions. For air preparation equipment precautions, refer to the “Handling Precautions for SMC Products” and the “Operation Manual” on the SMC website: <https://www.smcworld.com>

Selection

Warning

1. Do not select a model exceeding specification ranges and carefully consider the purpose of use, required specifications, and operating conditions, such as fluid, pressure, flow rate, nominal filtration rating, and environment.
2. The product is not certified under the High Pressure Gas Safety law, so for nitrogen, its maximum operating pressure will be 0.99 MPa (gauge pressure).
3. The product is provided for use in manufacturing industries. Contact us beforehand if the product will be used in an application such as a caisson shield, breathing, food (other than air-blowing), and/or medical treatment that affects the human body directly or indirectly.
4. The product removes and reduces bacteria contained in the compressed air. Bacterial removal refers to the effect of reducing bacteria. It does not mean that all bacteria are eliminated. Not for eliminating the virus.
LRV (Log Reduction Value) is a mathematical representation that was obtained from the test (evaluation based on JIS K 3835) using test bacteria (*Brevundimonas diminuta*).
5. The product is assembled and packaged in a clean room environment but does not adhere to the sanitation control procedures for the use in food and medical industries.
6. If the compressed air includes ozone, do not use it since it may damage the product or cause malfunction.

Mounting

Warning

1. Operation manual

Install the products and operate them only after reading the operation manual carefully and understanding its contents. Also, keep the manual where it can be referred to as necessary.

2. Flushing

Flush the piping line before using the product for the first time and after it has been replaced. Also, if piping, etc., is to be connected, flush (air blow) before using this product for the first time and after the element has been replaced in order to reduce the effects of the dust generated from the connection, etc. Flushing the line is also required to eliminate contamination resulting from the installation of piping lines. Therefore, be sure to flush the line before running the system. Make sure all mounting parts are secure before use.

Caution

1. Connect the piping in accordance with the flow direction marked on the case.

If connected in reverse, the element could break.

2. Mounting orientation does not affect the performance.

3

Caution on Installation

Caution

1. If the pressure difference (pressure drop) between the inlet and the outlet exceeds 0.1 MPa, it can cause damage to the product.
2. Do not install the product in a place where it can be affected by a pulsation (including surge pressure) of over 0.1 MPa.
3. Use caution regarding the particles that may be emitted from the outlet side of pneumatic equipment.
4. Set the air flow capacity with an initial pressure drop of 0.03 MPa or less. If the initial pressure drop is set to be high, its life will be shortened due to clogging.
5. Generally, the following pollutant particles are contained in compressed air.

[Pollutant particle substances contained in the compressed air]

- Moisture (drainage)
 - Dusts and particles which are in the surrounding air
 - Deteriorated oil which is discharged from the compressor
 - Solid foreign matter such as rust and/or oil in the piping
- 1) The SFDA series is not compatible with compressed air which contains fluids such as water and/or oil.
 - 2) Install a dryer (IDF, IDG, ID series), line filter (AFF-D series), mist separator (AM series), micro mist separator (AMD series), super mist separator (AME series), or odor removal filter (AMF series), etc., for the source of the air for the SFDA series.

6. Using with a flow-rate much higher than its specification could lead to exceeding the differential pressure the product can resist.

Use the product within its specifications. Also, take care about the replacement period of the product, taking into consideration that the differential pressure of the filter will increase over time.



SFDA Series

Specific Product Precautions 2

Be sure to read this before handling the products. Refer to the back cover for safety instructions. For air preparation equipment precautions, refer to the “Handling Precautions for SMC Products” and the “Operation Manual” on the SMC website: <https://www.smcworld.com>

Piping

Caution

1. Unpacking the sealed package

Since the filter is sealed in an antistatic double bag, the inner package should be unpacked in a clean atmosphere (such as a clean room).

2. When piping, apply a wrench to the width across flats of the connection port to prevent rotation.

3. Always tighten threads with the proper tightening torque.

When attaching fittings to the product, tighten with the proper tightening torque shown below.

Material	Thread size	Tightening torque [N·m]
Metal	1/4	12 to 14
	3/8	22 to 24

4. Check the arrow mark on the case which shows the flow direction to connect the IN and OUT ports correctly.

If connected in reverse, the element could break.

Maintenance

Warning

1. Perform maintenance and inspection according to the procedures indicated in the operation manual. If handled improperly, malfunction or damage of machinery and equipment may occur.

2. When removing the product, exhaust the air and ensure the air is released to atmosphere before removing it.

3. When the element comes to the end of its life, immediately replace it with a new filter or replacement element.

— Life of element —

The life of the element ends when either of the following two conditions occurs.

- 1) After 1 year of usage has elapsed.
- 2) When the pressure drop reaches 0.1 MPa even though the operating period has been less than 1 year

Operating Environment

Warning

1. Do not operate under the conditions listed below due to a risk of malfunction.

In locations containing corrosive gases, organic solvents, and chemical solutions, or in locations in which these elements are likely to adhere to the equipment

In locations in which sea water, water, or water steam could come in contact with the equipment

In locations that are exposed to direct sunlight (Shield the equipment from sunlight to prevent its resin material from ultraviolet ray degradation or overheating.)

In locations that have a heat source and poor ventilation (Shield the equipment from heat sources to protect it from softening degradation due to radiated heat.)

In locations that are exposed to shocks and vibrations

In locations with high humidity or large amounts of dust

2. When the product is used for blowing, use caution to prevent the work from being damaged by entrained air from the surrounding area.

If compressed air is used for air blow, compressed air blowing out from the blow nozzle may entrain foreign matter (solid particles and liquid particles) floating in the ambient air, blowing it against the workpieces and causing adhesion. Therefore, sufficient precautions must be taken about the ambient environment.

Safety Instructions

These safety instructions are intended to prevent hazardous situations and/or equipment damage. These instructions indicate the level of potential hazard with the labels of “**Caution**,” “**Warning**” or “**Danger**.” They are all important notes for safety and must be followed in addition to International Standards (ISO/IEC)*1), and other safety regulations.

 **Caution:** **Caution** indicates a hazard with a low level of risk which, if not avoided, could result in minor or moderate injury.

 **Warning:** **Warning** indicates a hazard with a medium level of risk which, if not avoided, could result in death or serious injury.

 **Danger:** **Danger** indicates a hazard with a high level of risk which, if not avoided, will result in death or serious injury.

*1) ISO 4414: Pneumatic fluid power – General rules relating to systems.
ISO 4413: Hydraulic fluid power – General rules relating to systems.
IEC 60204-1: Safety of machinery – Electrical equipment of machines.
(Part 1: General requirements)
ISO 10218-1: Manipulating industrial robots – Safety.
etc.

Warning

1. The compatibility of the product is the responsibility of the person who designs the equipment or decides its specifications.

Since the product specified here is used under various operating conditions, its compatibility with specific equipment must be decided by the person who designs the equipment or decides its specifications based on necessary analysis and test results. The expected performance and safety assurance of the equipment will be the responsibility of the person who has determined its compatibility with the product. This person should also continuously review all specifications of the product referring to its latest catalog information, with a view to giving due consideration to any possibility of equipment failure when configuring the equipment.

2. Only personnel with appropriate training should operate machinery and equipment.

The product specified here may become unsafe if handled incorrectly. The assembly, operation and maintenance of machines or equipment including our products must be performed by an operator who is appropriately trained and experienced.

3. Do not service or attempt to remove product and machinery/equipment until safety is confirmed.

1. The inspection and maintenance of machinery/equipment should only be performed after measures to prevent falling or runaway of the driven objects have been confirmed.
2. When the product is to be removed, confirm that the safety measures as mentioned above are implemented and the power from any appropriate source is cut, and read and understand the specific product precautions of all relevant products carefully.
3. Before machinery/equipment is restarted, take measures to prevent unexpected operation and malfunction.

4. Contact SMC beforehand and take special consideration of safety measures if the product is to be used in any of the following conditions.

1. Conditions and environments outside of the given specifications, or use outdoors or in a place exposed to direct sunlight.
2. Installation on equipment in conjunction with atomic energy, railways, air navigation, space, shipping, vehicles, military, medical treatment, combustion and recreation, or equipment in contact with food and beverages, emergency stop circuits, clutch and brake circuits in press applications, safety equipment or other applications unsuitable for the standard specifications described in the product catalog.
3. An application which could have negative effects on people, property, or animals requiring special safety analysis.
4. Use in an interlock circuit, which requires the provision of double interlock for possible failure by using a mechanical protective function, and periodical checks to confirm proper operation.

Caution

1. The product is provided for use in manufacturing industries.

The product herein described is basically provided for peaceful use in manufacturing industries.
If considering using the product in other industries, consult SMC beforehand and exchange specifications or a contract if necessary.
If anything is unclear, contact your nearest sales branch.

Limited warranty and Disclaimer/ Compliance Requirements

The product used is subject to the following “Limited warranty and Disclaimer” and “Compliance Requirements”.

Read and accept them before using the product.

Limited warranty and Disclaimer

1. The warranty period of the product is 1 year in service or 1.5 years after the product is delivered, whichever is first.*2)
Also, the product may have specified durability, running distance or replacement parts. Please consult your nearest sales branch.
2. For any failure or damage reported within the warranty period which is clearly our responsibility, a replacement product or necessary parts will be provided.
This limited warranty applies only to our product independently, and not to any other damage incurred due to the failure of the product.
3. Prior to using SMC products, please read and understand the warranty terms and disclaimers noted in the specified catalog for the particular products.

*2) Vacuum pads are excluded from this 1 year warranty.

A vacuum pad is a consumable part, so it is warranted for a year after it is delivered.
Also, even within the warranty period, the wear of a product due to the use of the vacuum pad or failure due to the deterioration of rubber material are not covered by the limited warranty.

Compliance Requirements

1. The use of SMC products with production equipment for the manufacture of weapons of mass destruction (WMD) or any other weapon is strictly prohibited.
2. The exports of SMC products or technology from one country to another are governed by the relevant security laws and regulations of the countries involved in the transaction. Prior to the shipment of a SMC product to another country, assure that all local rules governing that export are known and followed.

Caution

SMC products are not intended for use as instruments for legal metrology.

Measurement instruments that SMC manufactures or sells have not been qualified by type approval tests relevant to the metrology (measurement) laws of each country. Therefore, SMC products cannot be used for business or certification ordained by the metrology (measurement) laws of each country.

Safety Instructions

Be sure to read the “Handling Precautions for SMC Products” (M-E03-3) and “Operation Manual” before use.