

Compact / Lightweight 2 Port Solenoid Valve

VDW30/40-XF Series

For Air/Water



RoHS

IP65

● Compact /Lightweight resin body (PPS)

Weight: 120 g
(VDW30-XF)

● Power consumption

3 W (Standard)

0.5 W (With power-saving circuit)

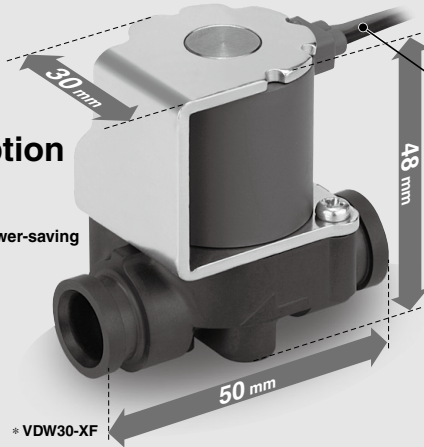

Electrical entry direction can be selected.

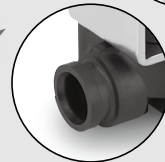
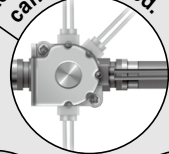

Quick fastener

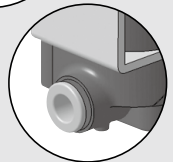

One-touch fitting

Piping labor reduced No torque control needed, easy handling.

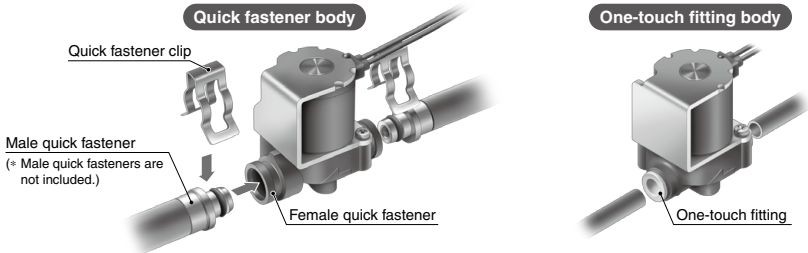

VCH□

VDW

SX10

VQ

LVM

Application Examples

Fuel cell cogeneration system ^{Note)}



Dispenser

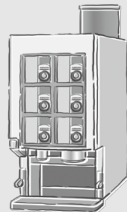

Automatic faucet

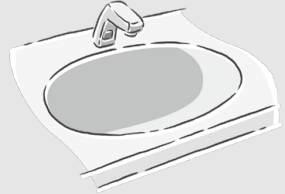

Note) A portion of the design and development work for this product was conducted as part of the Peripheral Equipment Technology Development for Household Fuel Cell Systems project sponsored by the New Energy and Industrial Technology Development Organization (NEDO). In principle, supply of the product for household fuel cell system applications with a capacity of 3 kW or less commences in April 2010.

Compact / Lightweight 2 Port Solenoid Valve

For Air/Water

VDW30/40-XF Series



How to Order Valves (Single Unit)

VDW **3** **1** - **5** **G** - **1** - **P7** - - - **XF**

Series

3	30
4	40

Valve type

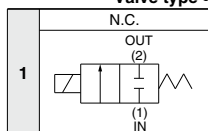

Voltage

5	24 VDC
6	12 VDC

Coil type

G	Grommet
---	---------

Power-saving circuit

Nil	None
E	With power-saving circuit

Option

Nil	None
N	Bottom mounting insert type
K	With 2 quick fastener clips (Note)

(Note) Port connection type: Supports P7 and P10 quick fasteners only.

Body material and coil insulation type

Symbol	Body material	Seal material	Coil insulation
Nil	PPS	NBR	Class B
A		FKM	
B		EPDM	

Port connection type

Symbol	Size	Series
P7	P7 quick fastener	30
P10	P10 quick fastener	40
C4	One-touch fitting for ø4	30
C6	One-touch fitting for ø6	
C8	One-touch fitting for ø8	
C10	One-touch fitting for ø10	40

Electrical entry direction

Symbol	Piping direction	Symbol	Electrical entry direction
Nil	IN OUT	L1	45° left direction IN OUT
R2	90° right direction IN OUT	L2	90° left direction IN OUT

(Note) Cannot be reassembled in different combinations.

Orifice diameter

Symbol	Orifice diameter (mm ø)	Series
1	1.0	30
3	3.0	
4	4.5	
6	6.0	40

Quick Fastener Clip Part No.

Series	Size	Quick fastener clip part no. (2 pcs.)	Material
30	P7 quick fastener	VDW30-CP7	Stainless steel
40	P10 quick fastener	VDW40-CP10	

* Ten pieces come in each set.

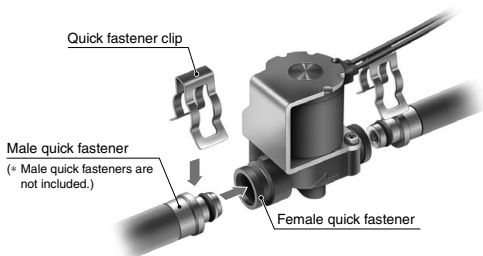

Male quick fastener
(* Male quick fasteners are not included.)

Female quick fastener

Standard Specifications



Valve specifications	Valve construction	Direct operated poppet	
	Valve type	Normally closed (N.C.)	
	Fluid	Quick fastener type	Water (1 to 50°C), Air, Heated water (80°C) ^{Note 3)} , Low vacuum (133 Pa-abs)
		One-touch fitting type ^{Note 4)}	Air, Water (1 to 40°C) ^{Note 5)} , Low vacuum (133 Pa-abs)
	Withstand pressure	1.0 MPa	
	Ambient temperature	-10 to 50°C	
	Fluid temperature	1 to 50°C (No freezing)	
	Ambient humidity	RH85%	
	Environment	Location without corrosive or explosive gases	
	Valve leakage ^{Note 1)}	0.1 cm ³ /min or less (With water pressure), 1 cm ³ /min or less (Air)	
	Exterior leakage	0.1 cm ³ /min or less (With water pressure), 1 cm ³ /min or less (Air)	
	Mounting orientation	Upward coil	
	Vibration/Impact ^{Note 2)}	30 m/s ² / 90 m/s ²	
Coil specifications	Port size	P7, P10 (Quick fastener) C4, C6, C8, C10 (One-touch fitting)	
	Orifice diameter	ø1, ø3, ø4.5, ø6	
	Rated voltage	24 VDC, 12 VDC	
	Allowable voltage fluctuation	±10% of rated voltage	
	Coil insulation type	Class B	
	Insulation resistance	500 VDC, 10 MΩ or more	
	Voltage limit	1800 VAC, 1 sec., 3 mA or less	
	Noise tolerance ^{Note 3)}		Simulation noise: 500 Vp-p (Based on 1 μsec. pulse width, 50 ±10 Hz frequency noise simulation)
			Fast transient noise: IEC61000-4-4: 1 kV
	Power consumption	VDW30: 3 W (With 0.5 W power-saving circuit) VDW40: 6.5 W (With 1 W power-saving circuit)	
Enclosure	IP65 ^{Note 6)}		

Note 1) The amount of leakage from the OUT port when the set pressure is applied to the IN port.

Note 2) Vibration resistance ----- No malfunction when tested with one sweep of 10 to 150 Hz in the axial direction and at a right angle to the armature, in both energized and deenergized states.

Impact resistance ----- No malfunction when tested with a drop tester in the axial direction and at a right angle to the main armature, one time each in energized and deenergized states.

Note 3) Products with power-saving circuit only.

Note 4) When using One-touch fittings, make sure to employ tubing that is compatible with SMC fittings (KQ2 series).

Note 5) When using One-touch fittings with water, care must be taken when handling tubing and piping conditions to prevent water from leaking when the tubes are inserted. Soft nylon tubing cannot be used with water.

Note 6) When using the product in a place which requires water resistance, please contact SMC.

Characteristic Specifications

Model	Port connection type	Orifice dia. (mm ø)	Max. operating pressure differential (MPa) ^{Note 1)}		Operating Pressure range (MPa) ^{Note 2)} ^{Note 3)}	Weight (kg)
			Pressure port 1			
VDW30	P7 C4, C6	1.0	0.6		-0.1 to 0.6	0.1
		3.0	0.1			
VDW40	P10 C8, C10	4.5	0.1 (With power-saving circuit)			
			0.05 (Without power-saving circuit)			
		6.0	0.05 (With power-saving circuit)			
			0.02 (Without power-saving circuit)			

Note 1) The maximum operating pressure differential changes depending on the flow direction of the fluid. Refer to page 503 for details.

Note 2) For low vacuum specifications, the operating pressure range is 1 Torr (1.33 x 10² Pa) to 0.6 MPa.

Please consult with SMC if using below 1 Torr (1.33 x 10² Pa).

Some leakage is permitted, so avoid use in situations where a vacuum must be maintained, such as in leak testing.

Note 3) The surge pressure must be under the maximum operating pressure.

Flow Rate Characteristics

Model	Port connection type	Orifice dia. (mm ø)	Water		Air		
			1→2 (IN→N.C.)		1→2 (IN→N.C.)		
			N.C.	Kv	Cv converted	C [dm ³ /(s·bar)]	b
VDW30	P7, C4, C6	1.0	0.03	0.04	0.14	0.4	0.09
		3.0	0.24	0.28	1.0	0.52	0.3
VDW40	P10, C8, C10	4.5	0.54	0.61	2.3	0.46	0.61
		6.0	0.86	1.0	4.0	0.4	1.1



VDW30/40 Series

Specific Product Precautions 1

Be sure to read this before handling the products. Refer to back page 50 for Safety Instructions, pages 17 to 19 for Fluids Control 2 Port Valves Precautions, and pages 467 to 470 for VDW Series/Specific Product Precautions.

Selection

⚠ Warning

1. Fluid quality

In the case of water

The use of a fluid which contains foreign matter can cause problems such as malfunction and seal failure by promoting wear of the valve seat and armature, and by sticking to the sliding parts of the armature, etc. Install a suitable filter (strainer) immediately upstream from the valve. In general, a mesh of about 50 to 100 is a guideline for the filter.

When using ordinary tap water, scaling and sludge from substances in hard water such as calcium and magnesium can cause solenoid valves to malfunction. It is therefore necessary to install a water softener to remove such substances and a filter (strainer) immediately before the solenoid valve.

In the case of air

Please use ordinary compressed air where a filter of 40 μm or less is provided on the inlet side piping. (Except dry air)

⚠ Caution

1. Leakage voltage

When the solenoid valve is operated using the controller, etc., the leakage voltage should be the product allowable leakage voltage or less.

Particularly when using a resistor in parallel with a switching element and using a C-R element (surge voltage suppressor) to protect the switching element, take note that leakage current will flow through the resistor, C-R element, etc., creating a possible danger that the valve may not turn off.

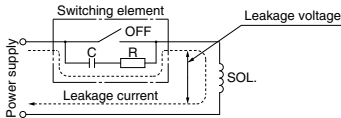

- 1) Take steps to ensure that there are no problems such as abnormal voltage drops or insufficient capacity associated with the signal power supply used to drive the solenoid valve.
- 2) Make sure the leakage current flowing through the solenoid valve when power is not being supplied is 0.1 mA or less. If there the leakage current is larger than this, take appropriate measures such as connecting a bleeder resistor (models with power-saving circuit).
- 3) An attenuation function is provided to reduce voltage surges produced by the solenoid valve. However, the controller should be equipped with protection against voltage surges as some residual surge voltage may still reach external components.

DC coil

2% or less of rated voltage

2. Low temperature operation

- 1) The valves can be used up to an ambient temperature of -10°C, however take measures to prevent solidification of impurities or freezing, etc.
- 2) When using valves for water application in cold climates, first stop the water supply/discharge of the pump, etc., and then take measures to prevent freezing such as draining water in pipe. When heating by steam, be careful not to expose the coil portion to steam. Also, please take measures to prevent freezing such as heating the body.

Mounting

⚠ Warning

1. When the valve is secured using an insert nut (part number suffix "-N"), handle with care during installation because the application of excessive stress to the body could damage it (appropriate tightening torque: 0.8 to 1.0 N·m).

Piping

⚠ Warning

1. During use, deterioration of the tubing or damage to the fittings could cause tubes to come loose from their fittings and thrash about.

To prevent uncontrolled tube movement, install protective covers or fasten tubes securely in place.

⚠ Caution

1. Connection of piping to products

- When connecting piping to a product, refer to its operation manual to avoid mistakes regarding the supply port, etc.
- Do not apply external force to the coil when holding it to connect piping, as the tube may deform.
- When attaching fittings to a solenoid valve, do not use fittings that do not conform to the quick fastener standard.
- Handle with care when attaching fittings because the application of excessive stress to the quick fastener portion could damage the body.

Recommended Piping Conditions

1. When connecting tubes using One-touch fittings, provide some spare tube length as shown in Fig. 1, recommended piping configuration.

Also, do not apply external force to the fittings when binding tubes with bands, etc. (see Fig. 2.)

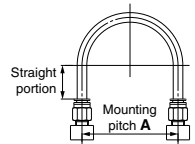

Fig. 1 Recommended piping configuration

Unit: mm

Tube size	Mounting pitch A			Straight portion length
	Nylon tube	Soft nylon tube	Polyurethane tube	
ø4	56 or more	30 or more	26 or more	20 or more
ø6	84 or more	39 or more	39 or more	30 or more
ø8	112 or more	58 or more	52 or more	40 or more
ø10	140 or more	70 or more	69 or more	50 or more

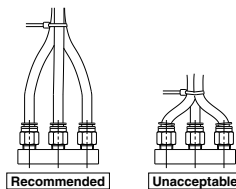

Fig. 2 Binding tubes with bands



VDW30/40 Series Specific Product Precautions 2

Be sure to read this before handling the products. Refer to back page 50 for Safety Instructions, pages 17 to 19 for Fluids Control 2 Port Valves Precautions, and pages 467 to 470 for VDW Series/Specific Product Precautions.

Electrical Connections

⚠ Caution

- Solenoid valves with power-saving circuits (coil part number “-5GE”) have polarity, so follow the wiring diagram below when making connections. Standard coils have no polarity.**

The solenoid valve will not switch properly if the polarity is reversed.

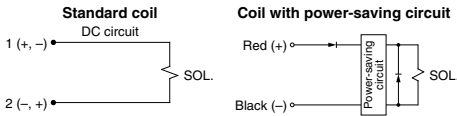

- Apply the correct voltage.**

Incorrect voltage could cause shorting of the power-saving circuit, coil burnout, or valve malfunction.

- Do not apply a tension load of 30 N or more to the solenoid valve lead wires.**

- Apply voltage which is within $\pm 10\%$ of the rated voltage.**

Also, do not use excessive power supply voltage or superimpose electrical noise such as ripple voltage on the power supply voltage as these could harm the valve.

- When connecting an induction load such as a circuit protector to the solenoid valve connection, take measures to ensure that the current to the solenoid valve is not reduced too much.**

Maintenance

⚠ Warning

- Do not disassemble solenoid valves.**
Disassembling a solenoid valve will void its warranty.

- Low frequency operation**

Switch valves at least once every 30 days to prevent malfunction. Also, in order to use it under the optimum state, conduct a regular inspection once a half year.

⚠ Caution

- Store indoors in a location away from direct sunlight and where the following conditions are maintained.**

- Temperature: -10 to 50°C
- Relative humidity: 20% to 85%RH (No condensation)
- Liquid rings may not be used.

- Storage**

When not using for a long time (more than approx. one month) after use with liquid, thoroughly remove all moisture to prevent rust and deterioration of rubber materials, etc.

Fluid Flow Direction

⚠ Caution

The maximum operating pressure differential differs depending on the flow direction of the fluid. If the pressure differential at each port exceeds the values in the table below, valve leakage may occur.

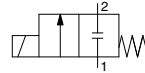

2 Port Valve

Model	Orifice diameter (mm ϕ)	Max. operating pressure differential (MPa)
		Pressure port 1
VDW30	1.0	0.6
	3.0	0.1
VDW40	4.5	0.1 (With power-saving circuit)
		0.05 (Without power-saving circuit)
	6.0	0.05 (With power-saving circuit)
		0.02 (Without power-saving circuit)

One-touch Fittings

⚠ Caution

For information on handling One-touch fittings and appropriate tubing, see the KQ2 series One-touch fittings in Best Pneumatics No. 7.

VCH □

VDW

SX10

VQ

LVM