

# Air Cylinder

## MB1 Series

ø32, ø40, ø50, ø63, ø80, ø100, ø125

RoHS



10% lighter  
(ø50-100 stroke)

Current model

1.9 kg



MB1 Series

1.7 kg

Reduced weight by changing the shape of the rod cover and head cover.

Can mount small auto switches on 4 surfaces.

Page 437

Dustproof

Fastener on auto switch mounting groove for dust-prevention (Option)

Page 437

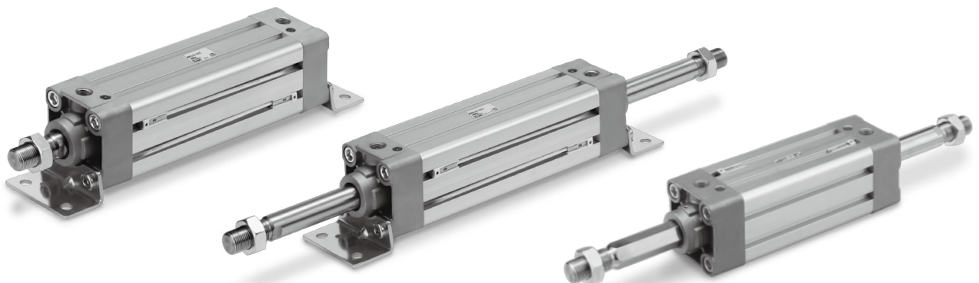

CJ1

CJP

CJ2

JCM

CM2

CM3

CG1

CG3

JMB

MB

**MB1**

CA2

CS1

CS2

D-□

-X□

Technical Data

## Part numbers with rod end bracket and/or pivot bracket available

Not necessary to order a bracket for the applicable cylinder separately

(Note) Mounting bracket is shipped together with the product, but not assembled.

Example) **MDB1** D **40-100Z-** **N** **V** **-M9BW**

• Mounting type

Pivot bracket	
<b>Nil</b>	No bracket
<b>N</b>	Pivot bracket is shipped together with the product, but not assembled.

Double clevis



Rod end bracket	
<b>Nil</b>	No bracket
<b>V</b>	Single knuckle joint
<b>W</b>	Double knuckle joint

With rod end bracket

**V:** Single knuckle joint

**W:** Double knuckle joint



\* Applicable to only D (Double clevis) mounting type.

## Various mounting bracket options

- Suitable mounting brackets can be selected for the installation condition.
- Improved amount of mounting freedom

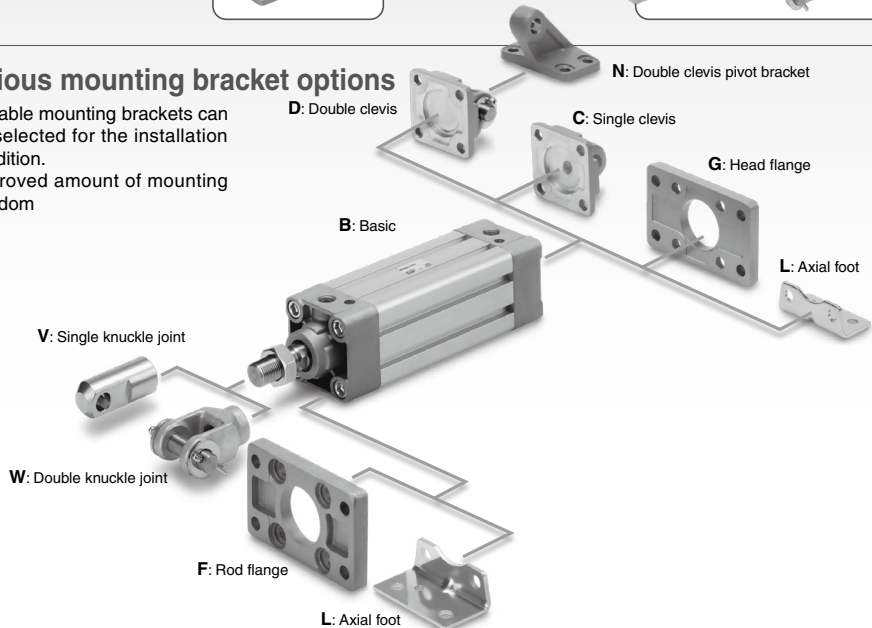

## Bracket Combinations

Bracket combination available.....Circled numbers are those shown in figures below.

Bracket for cylinder \ Bracket for workpiece	Single clevis	Double clevis	Single knuckle joint	Double knuckle joint	Clevis pivot bracket
Single clevis	—	①	—	②	—
Double clevis	③	—	④	—	⑨
Single knuckle joint	—	⑤	—	⑥	—
Double knuckle joint	⑦	—	⑧	—	⑩

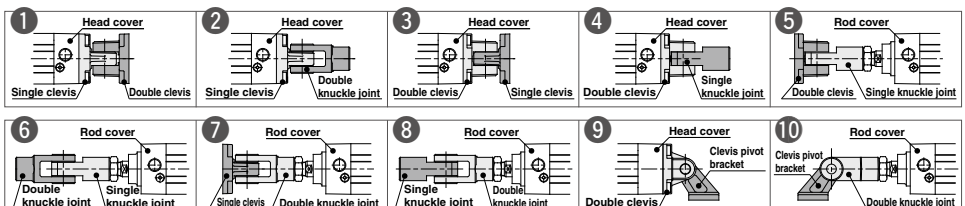

## Features

### Lightweight

Reduced weight by changing the shape of the rod cover and head cover.

Bore size [mm]	MB1	Reduction rate [%]	Current model <sup>[kg]</sup>
32	0.8	11	0.9
40	1.0	9	1.1
50	1.7	11	1.9
63	2.1	9	2.3
80	3.6	10	4.0
100	4.9	8	5.3
125	7.6	0	7.6

\* At 100 stroke

### Applicable speed/load

- Piston speed: Max. **1000** mm/s ( $\phi 32$  to  $\phi 125$ )
- Load yield: See table below.

Bore size [mm]	Maximum load mass <sup>[kg]</sup>
32	80
40	140
50	190
63	310
80	500
100	800
125	1250

\* Speed: 200 mm/s

Mounting dimensions are the same as the current product.



Can mount small auto switches on 4 surfaces.

- D-M9
- D-A9

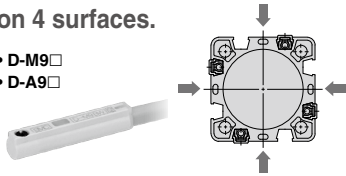

### Dust-prevention from fastener (Option)

- 1 Fastener avoids dust and foreign matter from entering or accumulating in the auto switch mounting groove.
- 2 Flat outer circumference prevents dust and foreign matter from accumulating

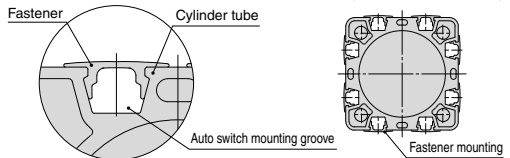

## Series Variations

Series	Type	Cushion	Bore size [mm]							Built-in magnet	With rod boot	Water resistant	Page
			32	40	50	63	80	100	125				
Standard Single rod MB1-Z	Double acting, Single rod	Rubber	●	●	●	●	●	●	●	●	●	440	
		Air	●	●	●	●	●	●	●	●	●		
Standard Double rod MB1W-Z	Double acting, Double rod	Rubber	●	●	●	●	●	●	●	●	●	450	
		Air	●	●	●	●	●	●	●	●	●		
Non-rotating rod Single rod MB1K-Z	Double acting, Single rod	Rubber	●	●	●	●	●	●	●	●	●	456	
		Air	●	●	●	●	●	●	●	●	●		

CJ1

CJP

CJ2

JCM

CM2

CM3

CG1

CG3

JMB

MB

MB1

CA2

CS1

CS2

D-

-X

Technical Data

# Combinations of Standard and Made to Order Specifications

## MB1 Series

- : Standard
- ◎ : Made to Order
- : Special product (Please contact SMC for details.)
- : Not available

Series	<b>MB1 (Standard type)</b>			
Action/ Type	<b>Double acting</b>			
Cushion Page	<b>Single rod</b>			
	Air	Rubber		
	440			

Symbol	Specifications	Applicable bore size	440				
			ø32 to ø100	ø125	ø32 to ø100	ø125	
Standard	Standard		●	●	●	●	
Long st	Long stroke		○	○	○	○	
D	Built-in magnet		●	●	●	●	
MB1□□ <sup>J</sup> <sub>K</sub>	With rod boot	ø32 to ø125	●	●	●	●	
10 <sub>—</sub> <sup>Note 4)</sup>	Clean series		○	○	○	○	
20 <sub>—</sub> <sup>Note 4)</sup>	Copper <sup>Note 3)</sup> and Fluorine-free		●	○	●	○	
MB1□□ <sup>V</sup>	Water resistant		●	○	●	○	
XA□	Change of rod end shape		◎	◎	◎	◎	
XB5 <sup>Note 4)</sup>	Oversized rod cylinder		◎	○	○	○	
XB6	Heat resistant cylinder (−10 to 150°C)	◎	○	○	○		
XC3 <sup>Note 4)</sup>	Special port location	◎	○	○	○		
XC4	With heavy duty scraper	◎	○	◎	○		
XC5	Heat resistant cylinder (−10 to 110°C)	◎	○	○	○		
XC6	Piston rod and rod end nut made of stainless steel	—	◎	—	◎		
XC7	Tie-rod, cushion valve, tie-rod nut, etc. made of stainless steel	ø32 to ø125	◎	○	◎	○	
XC8	Adjustable stroke cylinder/ Adjustable extension type		◎	○	◎	○	
XC9	Adjustable stroke cylinder/ Adjustable retraction type		◎	○	◎	○	
XC10	Dual stroke cylinder/Double rod type		◎	○	◎	○	
XC11	Dual stroke cylinder/Single rod type		◎	○	◎	○	
XC12	Tandem cylinder		◎	○	◎	○	
XC22	Fluororubber seal		◎	○	◎	○	
XC26	With split pins for double clevis pin/double knuckle joint pin and flat washers		ø125	—	◎	—	◎
XC27	Double clevis and double knuckle joint pins made of stainless steel			◎	◎	◎	◎
XC29	Double knuckle joint with spring pin			◎	○	◎	○
XC30	Rod trunnion	◎ <sup>Note 1)</sup>		○	◎ <sup>Note 1)</sup>	○	
XC35	With coil scraper	◎		○	◎	○	
XC65	Made of stainless steel (Combination of XC7 and XC68)	◎		○	◎	○	
XC68	Piston rod and rod end nut made of stainless steel (with hard chrome plated piston rod)	ø32 to ø125	◎	○	◎	○	
X846	Fastener strips mounted on switch mounting grooves		◎	◎	◎	◎	

Note 1) T bracket can be used only when selecting XC30.

Note 2) XC10 specification for the MBK series is the non-rotating type on both sides. For only one side, submit a special order request form.

Note 3) Copper-free for the externally exposed part. For details, refer to the Web Catalog.

Note 4) The cover shape is the same as the current product.

MB1W (Standard type)				MB1K (Non-rotating rod type)		Symbol
Double acting						
Double rod				Single rod		
Air		Rubber		Air	Rubber	
450				456		
ø32 to ø100	ø125	ø32 to ø100	ø125	ø32 to ø100		
●	●	●	●	●	●	Standard
○	○	○	○	○	○	Long st
●	●	●	●	●	●	D
●	●	●	●	●	●	MB1□-□ <sup>J</sup> <sub>K</sub>
○	○	○	○	○	○	10-
●	○	●	○	—	—	20-
●	○	●	○	—	—	MB1□ <sup>R</sup> <sub>V</sub>
⊙	⊙	⊙	⊙	⊙	⊙	XA□
○	○	○	○	○	○	XB5
⊙	○	○	○	○	○	XB6
⊙	○	⊙	○	⊙	⊙	XC3
⊙	○	⊙	○	—	—	XC4
⊙	○	○	○	○	○	XC5
—	○	—	○	○	○	XC6
⊙	○	⊙	○	⊙	⊙	XC7
—	—	—	—	⊙	⊙	XC8
—	—	—	—	⊙	⊙	XC9
—	—	—	—	⊙ <sup>Note 2)</sup>	⊙ <sup>Note 2)</sup>	XC10
—	—	—	—	○	○	XC11
○	○	○	○	○	○	XC12
⊙	○	⊙	○	○	○	XC22
—	—	—	—	—	—	XC26
—	—	—	—	⊙	⊙	XC27
○	○	○	○	○	○	XC29
⊙ <sup>Note 1)</sup>	○	⊙ <sup>Note 1)</sup>	○	⊙ <sup>Note 1)</sup>	⊙ <sup>Note 1)</sup>	XC30
⊙	○	⊙	○	—	—	XC35
⊙	⊙	⊙	⊙	○	○	XC65
⊙	○	⊙	○	—	—	XC68
⊙	⊙	⊙	⊙	⊙	⊙	X846

- CJ1
- CJP
- CJ2
- JCM
- CM2
- CM3
- CG1
- CG3
- JMB
- MB
- MB1**
- CA2
- CS1
- CS2

- D-□
- X□
- Technical Data

# Square Tube Type Air Cylinder: Standard Type Double Acting, Single Rod

## MB1 Series

RoHS

ø32, ø40, ø50, ø63, ø80, ø100, ø125

### How to Order

**MB1 B 32** - **50** - **Z** - **M9BW**

**With auto switch** **MDB1 B 32** - **50** - **Z** - **M9BW**

**With auto switch**  
(Built-in magnet)

**Mounting type**

B	Basic
L	Axial foot
F	Rod flange
G	Head flange
C	Single clevis
D	Double clevis

\* Mounting bracket is shipped together with the product, but not assembled (except ø125).

**Bore size**

32	32 mm
40	40 mm
50	50 mm
63	63 mm
80	80 mm
100	100 mm
125	125 mm

**Port thread type**

Nil	Rc
TN	NPT
TF	G

**Cylinder stroke [mm]**

Refer to "Standard Strokes" on page 441.

**Suffix (Rod boot)**

Nil	None
J	Nylon tarpaulin
K	Heat resistant tarpaulin

**Suffix (Cushion)**

Nil	Air cushion
N*	Rubber bumper

\* Since the bumpers are attached to the both sides of the piston for rubber bumper type, the overall length is longer than the cylinder with air cushion as follows: ø32, ø40: +6 mm, ø50, ø63: +8 mm, ø80, ø100: +10 mm, ø125: +12 mm.

**Number of auto switches**

Nil	2 pcs.
S	1 pc.
3	3 pcs.
n	"n" pcs.

**Auto switch**

Nil	Without auto switch
-----	---------------------

\* For applicable auto switches, refer to the table below.

**Accessories 2**

Nil	No bracket
V	Single knuckle joint
W	Double knuckle joint

\* A knuckle joint pin is not provided with the single knuckle joint.  
\* Rod end bracket is shipped together with the product.

**Accessories 1**

Nil	No bracket
N	Pivot bracket

\* Only for D mounting type.  
\* Pivot bracket is shipped together with the product.  
\* For details, refer to page 448.

**Built-in Magnet Cylinder Model**

If a built-in magnet cylinder without an auto switch is required, there is no need to enter the symbol for the auto switch. (Example) MDB1B40-100Z

\* Refer to "Ordering Example of Cylinder Assembly" on page 441.

### Applicable Auto Switches/Refer to pages 1575 to 1701 for further information on auto switches.

Type	Special function	Electrical entry	Indicator light	Wiring (Output)	Load voltage		Auto switch model		Lead wire length [m]			Pre-wired connector	Applicable load			
					DC	AC	Perpendicular	In-line	0.5 (Nil)	1 (M)	3 (L)			5 (Z)		
Solid state auto switch	—	Grommet	Yes	3-wire (NPN)	24 V	5 V, 12 V	—	M9NV	M9N	●	●	●	○	Relay, PLC		
				3-wire (PNP)				M9PV	M9P	●	●	●	○			
				2-wire				M9BV	M9B	●	●	●	○			
	Diagnostic indication (2-color indicator)			3-wire (NPN)	M9NVW	M9NW	●	●	●	○						
				3-wire (PNP)	M9PVW	M9PW	●	●	●	○						
				2-wire	M9BWW	M9BW	●	●	●	○						
	Water resistant (2-color indicator)			3-wire (NPN)	M9NAV <sup>*1</sup>	M9NA <sup>*1</sup>	○	○	●	○						
				3-wire (PNP)	M9PAV <sup>*1</sup>	M9PA <sup>*1</sup>	○	○	●	○						
				2-wire	M9BAV <sup>*1</sup>	M9BA <sup>*1</sup>	○	○	●	○						
Reed auto switch	—	Grommet	Yes	3-wire (NPN equivalent)	24 V	12 V	100 V	A96V	A96	●	—	●	—	IC circuit	—	
				2-wire				A93V <sup>*2</sup>	A93	●	●	●	—	—		Relay, PLC
								A90V	A90	●	—	●	—	—		IC circuit

\*1 Water resistant type auto switches can be mounted on the above models, but in such case SMC cannot guarantee water resistance.

A water resistant type cylinder is recommended for use in an environment which requires water resistance.

\*2 1 m type lead wire is only applicable to the D-A93.

\* Lead wire length symbols: 0.5 m ..... Nil (Example) M9NV  
1 m ..... M (Example) M9NWM  
3 m ..... L (Example) M9NWL  
5 m ..... Z (Example) M9NWZ

\* Solid state auto switches marked with "○" are produced upon receipt of order.

\* Since there are other applicable auto switches than listed above, refer to page 461 for details.

\* For details about auto switches with pre-wired connector, refer to pages 1648 and 1649.

\* Auto switches are shipped together, (but not assembled).

# Square Tube Type Air Cylinder: Standard Type Double Acting, Single Rod **MB1 Series**

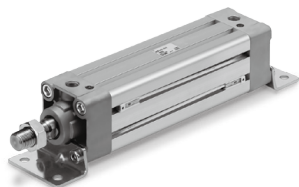

**Symbol**  
Double acting

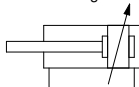

**Made to Order**  
Made to Order: Individual Specifications  
(For details, refer to page 462.)

Symbol	Specifications
-X846	Fastener strips mounted on switch mounting grooves

## Made to Order

[Click here for details](#)

Symbol	Specifications
-XA□	Change of rod end shape
-XB5	Oversized rod cylinder*1 *2 *3
-XB6	Heat resistant cylinder (-10 to 150°C)*1 *2
-XC3	Special port location*3
-XC4	With heavy duty scraper*2
-XC5	Heat resistant cylinder (-10 to 110°C)*1
-XC6	Piston rod and rod end nut made of stainless steel*4
-XC7	Tie-rod, cushion valve, tie-rod nut, etc. made of stainless steel*2
-XC8	Adjustable stroke cylinder/Adjustable extension type*2
-XC9	Adjustable stroke cylinder/Adjustable retraction type*2
-XC10	Dual stroke cylinder/Double rod type*2
-XC11	Dual stroke cylinder/Single rod type*2
-XC12	Tandem cylinder*2
-XC22	Fluororubber seal*2
-XC26	With split pins for double clevis pin/double knuckle joint pin and flat washers*1
-XC27	Double clevis and double knuckle joint pins made of stainless steel
-XC29	Double knuckle joint with spring pin*2
-XC30	Rod trunnion*2
-XC35	With coil scraper*2
-XC65	Made of stainless steel (Combination of XC7 and XC68)*2
-XC68	Piston rod and rod end nut made of stainless steel*2 (with hard chrome plated piston rod)

\*1 Air cushion only

\*2 Except ø125

\*3 The cover shape is the same as the current product.

\*4 ø125 only

For special port location (-XC3), the mounting bracket and port location can be determined using the standard product corresponding to the operating conditions. Also, this is only applicable to -XC3BB, -XC3CC and -XC3DD with trunnion bracket.

Refer to pages 460 and 461 for cylinders with auto switches.

- Auto switch proper mounting position (detection at stroke end) and its mounting height
- Minimum stroke for auto switch mounting
- Operating range
- Auto switch mounting brackets/Part no.

## Specifications

Bore size [mm]	32	40	50	63	80	100	125
<b>Action</b>	Double acting, Single rod						
<b>Fluid</b>	Air						
<b>Proof pressure</b>	1.5 MPa						
<b>Maximum operating pressure</b>	1.0 MPa						
<b>Minimum operating pressure</b>	0.05 MPa						
<b>Ambient and fluid temperature</b>	Without auto switch: -10 to 70°C (No freezing) With auto switch: -10 to 60°C (No freezing)						
<b>Lubrication</b>	Not required (Non-lube)						
<b>Piston speed</b>	50 to 1000 mm/s						
<b>Stroke length tolerance</b>	Up to 250: $^{+1.0}_0$ , 251 to 1000: $^{+1.4}_0$ , 1001 to 1500: $^{+1.8}_0$ , 1501 to 2000: $^{+2.2}_0$ , 2001 to 2300: $^{+2.6}_0$						
<b>Cushion</b>	Air cushion or Rubber bumper						
<b>Port size (Rc, NPT, G)</b>	1/8	1/4	3/8	1/2			
<b>Mounting</b>	Basic, Axial foot, Rod flange, Head flange Single clevis, Double clevis						

## Standard Strokes

Bore size	Standard stroke [mm]		Max. manufacturable stroke
	Stroke range ①	Stroke range ②	
<b>32</b>	25, 50, 75, 100, 125, 150, 175, 200, 250, 300, 350, 400, 450, 500	Up to 1800	Up to 1800
<b>40</b>	25, 50, 75, 100, 125, 150, 175, 200, 250, 300, 350, 400, 450, 500		
<b>50</b>	25, 50, 75, 100, 125, 150, 175, 200, 250, 300, 350, 400, 450, 500, 600		
<b>63</b>	25, 50, 75, 100, 125, 150, 175, 200, 250, 300, 350, 400, 450, 500, 600		
<b>80</b>	25, 50, 75, 100, 125, 150, 175, 200, 250, 300, 350, 400, 450, 500, 600, 700, 800		
<b>100</b>	25, 50, 75, 100, 125, 150, 175, 200, 250, 300, 350, 400, 450, 500, 600, 700, 800	Up to 2300	Up to 2300
<b>125</b>	25, 50, 75, 100, 125, 150, 175, 200, 250, 300, 350, 400, 450, 500, 600, 700, 800, 1000		

Note 1) Intermediate strokes are available. (No spacer is used.)

Note 2) Applicable strokes should be confirmed according to the usage. For details, refer to "Air Cylinders Model Selection" on front matter pages. In addition, the products that exceed the stroke range ① might not be able to fulfill the specifications due to the deflection etc.

Note 3) Please consult with SMC for manufacturability and the part numbers when exceeding the stroke range ②.  
Note 4) When using a rod boot, a stroke range of up to 1000 mm is available. Please consult with SMC when exceeding a 1000 mm stroke.

Note 5) Using a stroke of a length which is smaller than the effective cushion length may result in reduced air cushion performance. Refer to "Technical Data 1" on page 1901 for details on the effective cushion length.

## Rod Boot Material

Symbol	Rod boot material	Max. ambient temperature
<b>J</b>	Nylon tarpaulin	70°C
<b>K</b>	Heat resistant tarpaulin	110°C*

\* Max. ambient temperature for rod boot itself.

## Ordering Example of Cylinder Assembly

Cylinder model: **MDB1D50-100Z-NW-M9BW**

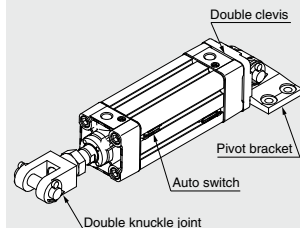

**Mounting D: Double clevis**  
**Pivot bracket N: Yes**  
**Rod end bracket W: Double knuckle joint**  
**Auto switch D-M9BW: 2 pcs.**

\*Pivot bracket, double knuckle joint and auto switch are shipped together with the product, but not assembled.

CJ1

CJP

CJ2

JCM

CM2

CM3

CG1

CG3

JMB

MB

**MB1**

CA2

CS1

CS2

D-□

-X□

Technical Data

# MB1 Series

## Accessories

Mounting		Basic	Axial foot	Rod flange	Head flange	Single clevis	Double clevis
Standard	Rod end nut	●	●	●	●	●	●
	Clevis pin	—	—	—	—	—	●
Option	Single knuckle joint	●	●	●	●	●	●
	Double knuckle joint (with pin)	●	●	●	●	●	●
	Rod boot	●	●	●	●	●	●

\* Refer to page 449 for part numbers and dimensions. (Refer to page 445 for rod boot.)

## Mounting Brackets/Part No.

Bore size [mm]	32	40	50	63	80	100	125
Axial foot (Note 1)	MB-L03	MB-L04	MB-L05	MB-L06	MB-L08	MB-L10	MB-L12
Rod/Head flange	MB-F03	MB-F04	MB-F05	MB-F06	MB-F08	MB-F10	MB-F12
Single clevis	MB-C03	MB-C04	MB-C05	MB-C06	MB-C08	MB-C10	MB-C12
Double clevis	MB-D03	MB-D04	MB-D05	MB-D06	MB-D08	MB-D10	MB-D12

Note 1) Order two feet per cylinder.

Note 2) Accessories for each mounting bracket are as follows. Axial foot, Rod/Head flange, Single clevis/Body mounting bolt; Double clevis/Body mounting bolt, Clevis pin, Split pins and Flat washers. → Refer to page 449 for details.

## Theoretical Force

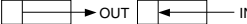
(Unit: N) 

Bore size [mm]	Rod diameter [mm]	Operating direction	Piston area [mm <sup>2</sup> ]	Operating pressure [MPa]									
				0.2	0.3	0.4	0.5	0.6	0.7	0.8	0.9	1.0	
32	12	OUT	804	161	241	322	402	482	563	643	724	804	
		IN	691	138	207	276	346	415	484	553	622	691	
40	16	OUT	1257	251	377	503	629	754	880	1006	1131	1257	
		IN	1056	211	317	422	528	634	739	845	950	1056	
50	20	OUT	1963	393	589	785	982	1178	1374	1570	1767	1963	
		IN	1649	330	495	660	825	989	1154	1319	1484	1649	
63	20	OUT	3117	623	935	1247	1559	1870	2182	2494	2805	3117	
		IN	2803	561	841	1121	1402	1682	1962	2242	2523	2803	
80	25	OUT	5027	1005	1508	2011	2514	3016	3519	4022	4524	5027	
		IN	4536	907	1361	1814	2268	2722	3175	3629	4082	4536	
100	30	OUT	7854	1571	2356	3142	3927	4712	5498	6283	7069	7854	
		IN	7147	1429	2144	2859	3574	4288	5003	5718	6432	7147	
125	32	OUT	12272	2454	3682	4909	6136	7363	8590	9818	11045	12272	
		IN	11468	2294	3440	4588	5734	6881	8028	9174	10321	11468	

Note) Theoretical force [N] = Pressure [MPa] x Piston area [mm<sup>2</sup>]

## Weights

[kg]

Bore size [mm]		32	40	50	63	80	100	125
Basic weight	Basic	0.47	0.62	1.1	1.36	2.54	3.51	5.68
	Axial foot	0.59	0.76	1.32	1.64	3.04	4.17	7.76
	Rod/Head flange	0.76	0.99	1.55	2.15	3.99	5.34	9.84
	Single clevis	0.72	0.85	1.44	1.99	3.65	5.09	8.25
	Double clevis	0.73	0.89	1.53	2.15	3.94	5.36	8.45
Additional weight per 50 mm of stroke	All mounting brackets	0.16	0.21	0.33	0.37	0.57	0.72	0.94
Accessories	Single knuckle joint	0.15	0.23	0.26	0.26	0.6	0.83	1.08
	Double knuckle joint (with pin)	0.22	0.37	0.43	0.43	0.87	1.27	1.58

Calculation

Example) **MB1B32-100Z** (Basic, ø32, 100 stroke)

- Basic weight ..... 0.47 (Basic, ø32)
- Additional weight ..... 0.16/50 stroke
- Cylinder stroke ..... 100 stroke

$$0.47 + 0.16 \times 100/50 = \mathbf{0.79 \text{ kg}}$$



## Kinetic Energy Absorbable by Cushion Mechanism

Bore size [mm]	Effective cushion length [mm]	Kinetic energy absorbable J
32	18.8	2.2
40	18.8	3.4
50	21.3	5.9
63	21.3	11
80	30.3	20
100	29.3	29
125	Rod side	31.4
	Head side	29.4
		43

### With Air Cushion

At the stroke end, when stopping a large amount of kinetic energy generated by a large load and high speed operation, compression of air is used to absorb the impact without transmitting vibration to the surroundings. The purpose of an air cushion is not to reduce the speed of a piston as it nears the stroke end. The kinetic energy of load can be found using the following formula.

$$E_k = \frac{M}{2} v^2$$

**E<sub>k</sub>**: Kinetic energy [J]

**M**: Mass of load [kg]

**v**: Piston speed [m/s]

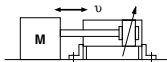

If the kinetic energy obtained is no greater than the absorbable kinetic energy shown in the table on the left, the life of the cushion seal will be 10 million cycles or more.

## Allowable Kinetic Energy

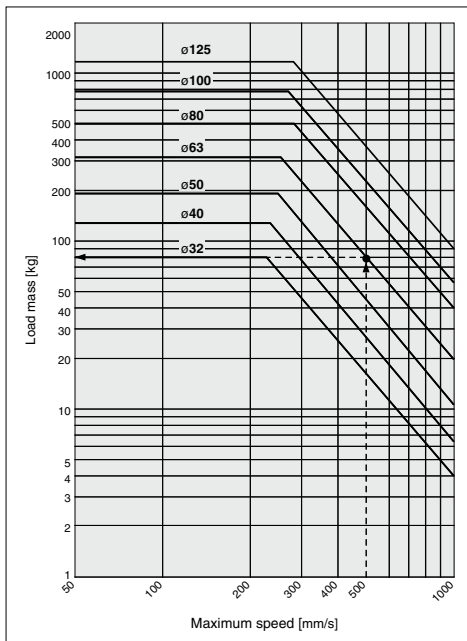

Example) Load limit at rod end when the air cylinder ø63 is actuated at 500 mm/s.  
Extend upward from 500 mm/s on the horizontal axis of the graph to the intersection point with the line for a tube bore size of 63 mm, and then extend leftward from this point to find the load of 80 kg.

CG1

CGP

CG2

JCM

CM2

CM3

CG1

CG3

JMB

MB

**MB1**

CA2

CS1

CS2

D-□

-X□

Technical Data

# MB1 Series

## Construction

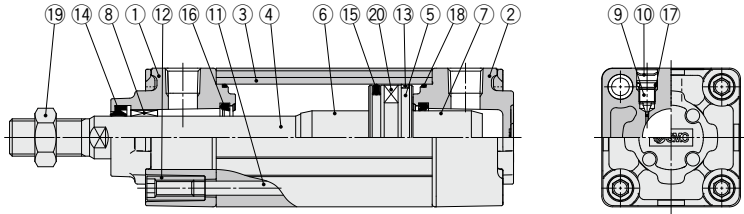

### Component Parts

No.	Description	Material	Q'ty	Note
1	Rod cover	Aluminum die-cast	1	Trivalent chromated
2	Head cover	Aluminum die-cast	1	Trivalent chromated
3	Cylinder tube	Aluminum alloy	1	Hard anodized
4	Piston rod	Carbon steel	1	Hard chrome plating
5	Piston	Aluminum alloy	1	
6	Cushion ring	Aluminum alloy	1	Anodized
7	Cushion ring B	Aluminum alloy	1	Anodized
8	Bushing	Bearing alloy	1	
9	Cushion valve	Steel wire	2	Trivalent zinc chromated
10	Retaining ring	Steel for spring	2	ø40 to ø125

No.	Description	Material	Q'ty	Note
11	Tie-rod	Carbon steel	4	Trivalent zinc chromated
12	Tie-rod nut	Carbon steel	8	Trivalent zinc chromated
13	Wear ring	Resin	1	
14*	Rod seal	NBR	1	
15*	Piston seal	NBR	1	
16*	Cushion seal	Urethane	2	
17	Cushion valve seal	NBR	2	
18*	Cylinder tube gasket	NBR	2	
19	Rod end nut	Rolled steel	1	Trivalent zinc chromated
20	Magnet	—	(1)	

### Replacement Parts/Seal Kit

Bore size [mm]	Kit no.	Contents
32	MB32Z-PS	Set of the nos. 14, 15, 16, 18
40	MB1-40Z-PS	
50	MB1-50Z-PS	
63	MB1-63Z-PS	
80	MB1-80Z-PS	
100	MB1-100Z-PS	
125	MB125-PS	

\* Seal kits consist of items 14, 15, 16, 18, and can be ordered by using the seal kit number corresponding to each bore size.

\* The seal kit includes a grease pack (10 g for ø32 to ø50, 20 g for ø63 and ø80, 30 g for ø100).

Order with the following part number when only the grease pack is needed.

**Grease pack part number: GR-S-010 (10 g), GR-S-020 (20 g)**

# Square Tube Type Air Cylinder: Standard Type Double Acting, Single Rod **MB1 Series**

## Standard

Basic: (B)

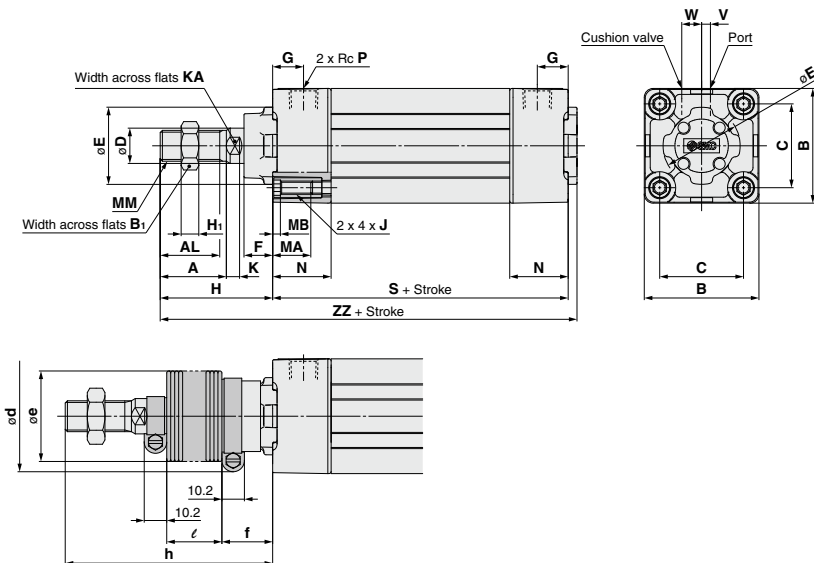

\* Since the bumpers are attached to the both sides of the piston for rubber bumper type, the overall length is longer than the cylinder with air cushion as follows:  $\phi 32, \phi 40$ : +6 mm,  $\phi 50, \phi 63$ : +8 mm,  $\phi 80, \phi 100$ : +10 mm,  $\phi 125$ : +12 mm.

### Rubber Bumper

Bore size [mm]	S	ZZ	Bore size [mm]	S	ZZ
32	90	141	63	102	164
40	90	145	80	124	200
50	102	164	100	124	200
			125	132	235

Bore size [mm]	A	AL	B	B1	C	D	E	F	G	H	H1	J	K	KA	MA	MB	MM	N	P	S*	V	W	ZZ*
32	22	19.5	46	17	32.5	12	30	13	13	47	6	M6 x 1	6	10	16	4	M10 x 1.25	26	1/8	84	4	6.5	135
40	30	27	52	22	38	16	35	13	14	51	8	M6 x 1	6	14	16	4	M14 x 1.5	26	1/4	84	4	9	139
50	35	32	65	27	46.5	20	40	14	15.5	58	11	M8 x 1.25	7	18	16	5	M18 x 1.5	30.5	1/4	94	5	10.5	156
63	35	32	75	27	56.5	20	45	14	16.5	58	11	M8 x 1.25	7	18	16	5	M18 x 1.5	30.5	3/8	94	9	12	156
80	40	37	95	32	72	25	45	20	19	72	13	M10 x 1.5	10	22	16	5	M22 x 1.5	37	3/8	114	11.5	14	190
100	40	37	114	41	89	30	55	20	19	72	16	M10 x 1.5	10	26	16	5	M26 x 1.5	37	1/2	114	17	15	190
125	50	50	136	41	110	32	60	27	19	97	16	M12 x 1.75	13	27	20	6	M27 x 2	38	1/2	120	17	15	223

### With Rod Boot (Up to 1000 mm stroke)

Bore size [mm]	d	e	f	$\ell$																	h																
				1 to 50	51 to 100	101 to 150	151 to 200	201 to 300	301 to 400	401 to 500	501 to 600	601 to 700	701 to 800	801 to 900	901 to 1000	1 to 50	51 to 100	101 to 150	151 to 200	201 to 300	301 to 400	401 to 500	501 to 600	601 to 700	701 to 800	801 to 900	901 to 1000										
32	54	36	23	12.5	25	37.5	50	75	100	125	150	175	200	225	250	73	86	98	111	136	161	186	211	236	261	286	311										
40	56	41	23	12.5	25	37.5	50	75	100	125	150	175	200	225	250	81	94	106	119	144	169	194	219	244	269	294	319										
50	64	51	25	12.5	25	37.5	50	75	100	125	150	175	200	225	250	89	102	114	127	152	177	202	227	252	277	302	327										
63	64	51	25	12.5	25	37.5	50	75	100	125	150	175	200	225	250	89	102	114	127	152	177	202	227	252	277	302	327										
80	68	56	29	12.5	25	37.5	50	75	100	125	150	175	200	225	250	101	114	126	139	164	189	214	239	264	289	314	339										
100	76	61	29	12.5	25	37.5	50	75	100	125	150	175	200	225	250	101	114	126	139	164	189	214	239	264	289	314	339										
125	82	75	27	10	20	30	40	60	80	100	120	140	160	180	200	120	130	140	150	170	190	210	230	250	270	290	310										

CJ1

CJP

CJ2

JCM

CM2

CM3

CG1

CG3

JMB

MB

**MB1**

CA2

CS1

CS2

D-□

-X□

Technical Data

# MB1 Series

## Standard/With Mounting Bracket

\* Refer to Basic (page 445) for other dimensions and with rod boot.

### Axial foot: (L)

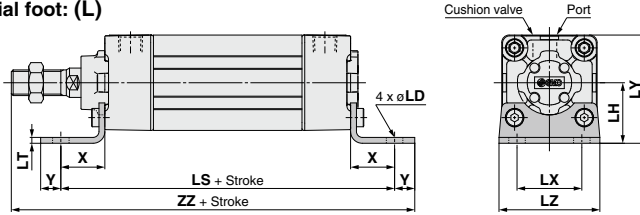

**Axial Foot**

Bore size [mm]	X	Y	LD	LH	LS*	LT	LX	LY	LZ	ZZ*	Rubber Bumper Bore size [mm]	LS	ZZ
32	22	9	7	30	128	3.2	32	53	50	162	32	134	168
40	24	11	9	33	132	3.2	38	59	55	170	40	138	176
50	27	11	9	40	148	3.2	46	72.5	70	190	50	156	198
63	27	14	12	45	148	3.6	56	82.5	80	193	63	156	201
80	30	14	12	55	174	4.5	72	102.5	100	230	80	184	240
100	32	16	14	65	178	4.5	89	122	120	234	100	188	244
125	45	20	14	81	210	8	90	149	136	282	125	222	294

### Rod flange: (F)

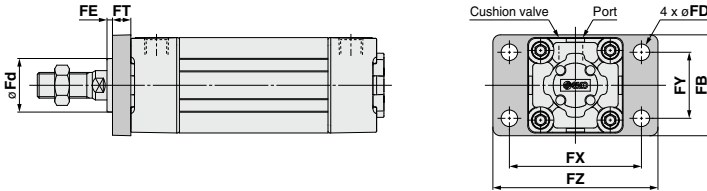

**Rod Flange**

Bore size [mm]	FB	FD	FE	FT	FX	FY	FZ	Fd
32	50	7	3	10	64	32	79	24.5
40	55	9	3	10	72	36	90	29.5
50	70	9	2	12	90	45	110	35.5
63	80	9	2	12	100	50	120	38.5
80	100	12	4	16	126	63	153	41
100	120	14	4	16	150	75	178	46
125	138	14	7	20	180	102	216	57

### Head flange: (G)

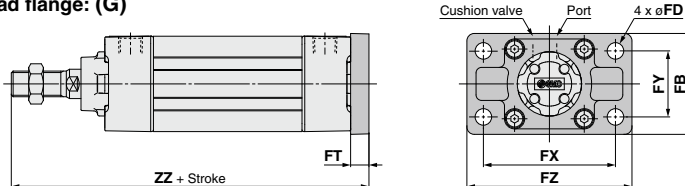

**Head Flange**

Bore size [mm]	FB	FD	FT	FX	FY	FZ	ZZ*	Rubber Bumper Bore size [mm]	ZZ
32	50	7	10	64	32	79	141	32	147
40	55	9	10	72	36	90	145	40	151
50	70	9	12	90	45	110	164	50, 63	172
63	80	9	12	100	50	120	164	80, 100	212
80	100	12	16	126	63	153	202	125	249
100	120	14	16	150	75	178	202		
125	138	14	20	180	102	216	237		

**Axial foot, Rod/Head flange**

\* Since the bumpers are attached to the both sides of the piston for rubber bumper type, the overall length is longer than the cylinder with air cushion as follows: ø32, ø40: +6 mm, ø50, ø63: +8 mm, ø80, ø100: +10 mm, ø125: +12 mm.

# Square Tube Type Air Cylinder: Standard Type Double Acting, Single Rod **MB1 Series**

## Standard/With Mounting Bracket

\* Refer to Basic (page 445) for other dimensions and with rod boot.

### Single clevis: (C)

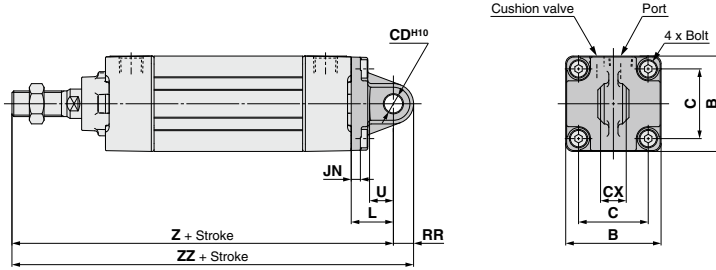

### Single Clevis

Bore size [mm]	B	C	JN	L	RR	U	CD <sup>H10</sup>	CX <sup>3/31</sup>	Z*	ZZ*	Bolt
32	46	32.5	5	23	10.5	13	10	14	154	164.5	M6-32-48-C1247
40	52	38	5	23	11	13	10	14	158	169	(M6 x 1 x 16L, Low head)
50	65	46.5	6	30	15	17	14	20	182	197	MB-50-48-C1249
63	75	56.5	6	30	15	17	14	20	182	197	(M8 x 1.25 x 18L, Low head)
80	95	72	8	42	23	26	22	30	228	251	MB-80-48BC1251
100	114	89	8	42	23	26	22	30	228	251	(M10 x 1.5 x 22L, Low head)
125	136	110	10	50	28	30	25	32	267	295	M12 x 1.75 x 28L, Low head

### Rubber Bumper

Bore size [mm]	Z	ZZ
32	160	170.5
40	164	175
50, 63	190	205
80, 100	238	261
125	279	307

### Double clevis: (D)

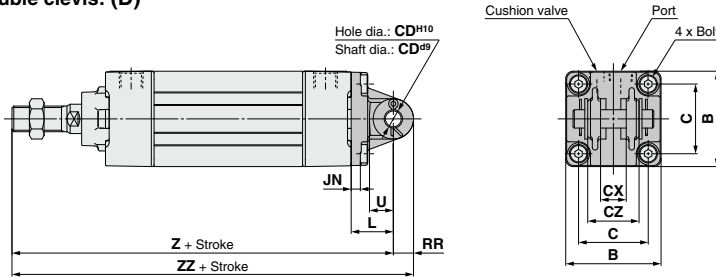

### Double Clevis

Bore size [mm]	B	C	JN	L	RR	U	CD <sup>H10</sup>	CX <sup>3/31</sup>	CZ	Z*	ZZ*	Bolt
32	46	32.5	5	23	10.5	13	10	14	28	154	164.5	MB-32-48-C1247
40	52	38	5	23	11	13	10	14	28	158	169	(M6 x 1 x 16L, Low head)
50	65	46.5	6	30	15	17	14	20	40	182	197	MB-50-48-C1249
63	75	56.5	6	30	15	17	14	20	40	182	197	(M8 x 1.25 x 18L, Low head)
80	95	72	8	42	23	26	22	30	60	228	251	MB-80-48BC1251
100	114	89	8	42	23	26	22	30	60	228	251	(M10 x 1.5 x 22L, Low head)
125	136	110	10	50	28	30	25	32	64	267	295	M12 x 1.75 x 28L, Low head

### Rubber Bumper

Bore size [mm]	Z	ZZ
32	160	170.5
40	164	175
50, 63	190	205
80, 100	238	261
125	279	307

#### Single/Double clevis

\* Since the bumpers are attached to the both sides of the piston for rubber bumper type, the overall length is longer than the cylinder with air cushion as follows: ø32, ø40: +6 mm, ø50, ø63: +8 mm, ø80, ø100: +10 mm, ø125: +12 mm.

CJ1

CJP

CJ2

JCM

CM2

CM3

CG1

CG3

JMB

MB

**MB1**

CA2

CS1

CS2

D-□

-X□

Technical Data

# MB1 Series

## Pivot Bracket/Double Clevis Pivot Bracket

### Part No.

Description	Bore size						
	MB□32	MB□40	MB□50	MB□63	MB□80	MB□100	MB□125
Double clevis pivot bracket	MB-B03		MB-B05		MB-B08		MB-B12

### Double clevis pivot bracket

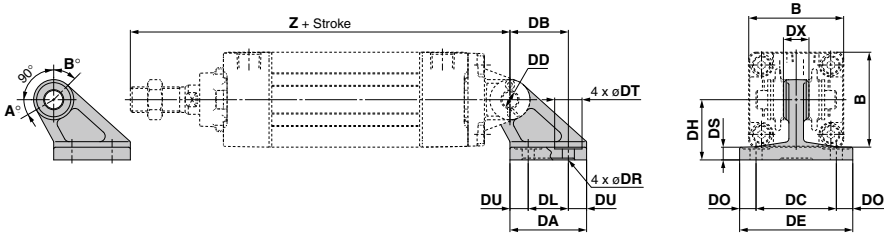

Part no.	Bore size [mm]	[mm]															Rubber Bumper	
		B	DA	DB	DL	DU	DC	DX	DE	DO	DR	DT	DS	DH	Z*	DD <sub>H10</sub>	Bore size [mm]	Z
MB-B03	32	46	42	32	22	10	44	14	62	9	6.6	15	7	33	154	10 <sup>+0.058</sup> <sub>0</sub>	32	160
	40	52	42	32	22	10	44	14	62	9	6.6	15	7	33	158	10 <sup>+0.058</sup> <sub>0</sub>	40	164
MB-B05	50	65	53	43	30	11.5	60	20	81	10.5	9	18	8	45	182	14 <sup>+0.070</sup> <sub>0</sub>	50	190
	63	75	53	43	30	11.5	60	20	81	10.5	9	18	8	45	182	14 <sup>+0.070</sup> <sub>0</sub>	63	190
MB-B08	80	95	73	64	45	14	86	30	111	12.5	11	22	10	65	228	22 <sup>+0.084</sup> <sub>0</sub>	80	238
	100	114	73	64	45	14	86	30	111	12.5	11	22	10	65	228	22 <sup>+0.084</sup> <sub>0</sub>	100	238
MB-B12	125	136	90	78	60	15	110	32	136	13	13.5	24	14	75	267	25 <sup>+0.084</sup> <sub>0</sub>	125	279

### Rotating Angle

Bore size [mm]	A°	B°	A° + B° + 90°
32, 40	25°	45°	160°
50, 63	40°	60°	190°
80, 100	30°	55°	175°
125	30°	50°	170°

### Clevis pivot bracket

\* Since the bumpers are attached to the both sides of the piston for rubber bumper type, the overall length is longer than the cylinder with air cushion as follows: ø32, ø40: +6 mm, ø50, ø63: +8 mm, ø80, ø100: +10 mm, ø125: +12 mm.

# Square Tube Type Air Cylinder: Standard Type **MB1 Series**

## Dimensions of Accessories

Rod end nut  
(Standard)

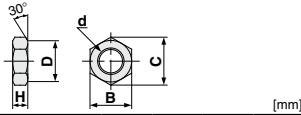

Part no.	Bore size [mm]	d	H	B	C	D
NT-03	32	M10 x 1.25	6	17	19.6	16.5
NT-04	40	M14 x 1.5	8	22	25.4	21
NT-05	50, 63	M18 x 1.5	11	27	31.2	26
NT-08	80	M22 x 1.5	13	32	37.0	31
NT-10	100	M26 x 1.5	16	41	47.3	39
NT-12M	125	M27 x 2	16	41	47.3	39

I type  
Single knuckle joint

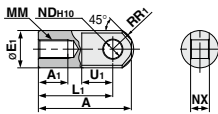

Part no.	Bore size [mm]	A	A <sub>1</sub>	E <sub>1</sub>	L <sub>1</sub>	MM	R <sub>1</sub>	U <sub>1</sub>	NDH <sub>10</sub>	NX
I-03M	32	40	14	20	30	M10 x 1.25	12	16	10 <sup>+0.058</sup> <sub>0</sub>	14 <sup>-0.10</sup> <sub>-0.30</sub>
I-04M	40	50	19	22	40	M14 x 1.5	12.5	19	10 <sup>+0.058</sup> <sub>0</sub>	14 <sup>-0.10</sup> <sub>-0.30</sub>
I-05M	50, 63	64	24	28	50	M18 x 1.5	16.5	24	14 <sup>+0.070</sup> <sub>0</sub>	20 <sup>-0.10</sup> <sub>-0.30</sub>
I-08M	80	80	26	40	60	M22 x 1.5	23.5	34	22 <sup>+0.084</sup> <sub>0</sub>	30 <sup>-0.10</sup> <sub>-0.30</sub>
I-10M	100	80	26	40	60	M26 x 1.5	23.5	34	22 <sup>+0.084</sup> <sub>0</sub>	30 <sup>-0.10</sup> <sub>-0.30</sub>
I-12M	125	119	36	46	92	M27 x 2	28.5	34	25 <sup>+0.084</sup> <sub>0</sub>	32 <sup>-0.10</sup> <sub>-0.30</sub>

Knuckle joint pin  
Clevis pin

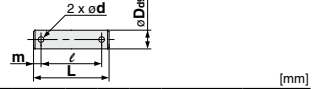

Part no.	Bore size [mm] Clevis /Knuckle	Dø8	L	ℓ	m	d (Drill through)	Split pin
CD-M03 <sup>Note</sup>	32, 40	10 <sup>-0.040</sup> <sub>-0.076</sub>	44	36	4	3	ø3 x 18ℓ
CD-M05 <sup>Note</sup>	50, 63	14 <sup>-0.053</sup> <sub>-0.083</sub>	60	51	4.5	4	ø4 x 25ℓ
CD-M08 <sup>Note</sup>	80, 100	22 <sup>-0.065</sup> <sub>-0.117</sub>	82	72	5	4	ø4 x 35ℓ
IY-12	125	25 <sup>-0.075</sup> <sub>-0.127</sub>	79.5	69.5	5	4	ø4 x 40ℓ

Note) Split pins and flat washers are included.

Y type  
Double knuckle joint

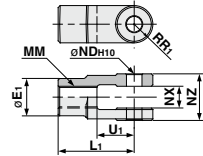

Part no.	Bore size [mm]	E <sub>1</sub>	L <sub>1</sub>	MM	R <sub>1</sub>	U <sub>1</sub>	NDH <sub>10</sub>	NX	NZ
Y-03M	32	20	30	M10 x 1.25	10	16	10 <sup>+0.058</sup> <sub>0</sub>	14 <sup>-0.30</sup> <sub>-0.10</sub>	28 <sup>-0.10</sup> <sub>-0.30</sub>
Y-04M	40	22	40	M14 x 1.5	11	19	10 <sup>+0.058</sup> <sub>0</sub>	14 <sup>-0.30</sup> <sub>-0.10</sub>	28 <sup>-0.10</sup> <sub>-0.30</sub>
Y-05M	50, 63	28	50	M18 x 1.5	14	24	14 <sup>+0.070</sup> <sub>0</sub>	20 <sup>-0.30</sup> <sub>-0.10</sub>	40 <sup>-0.10</sup> <sub>-0.30</sub>
Y-08M	80	40	65	M22 x 1.5	20	34	22 <sup>+0.084</sup> <sub>0</sub>	30 <sup>-0.30</sup> <sub>-0.10</sub>	60 <sup>-0.10</sup> <sub>-0.30</sub>
Y-10M	100	40	65	M26 x 1.5	20	34	22 <sup>+0.084</sup> <sub>0</sub>	30 <sup>-0.30</sup> <sub>-0.10</sub>	60 <sup>-0.10</sup> <sub>-0.30</sub>
Y-12M	125	46	100	M27 x 2	27	42	25 <sup>+0.084</sup> <sub>0</sub>	32 <sup>-0.30</sup> <sub>-0.10</sub>	64 <sup>-0.10</sup> <sub>-0.30</sub>

Note) A pin, split pins, and flat washers are included.

## Bracket Combinations

Bracket combination available ..... Refer to the figure below.

Bracket for cylinder	Single clevis	Double clevis	Single knuckle joint	Double knuckle joint	Clevis pivot bracket
Single clevis	—	①	—	②	—
Double clevis	③	—	④	—	⑨
Single knuckle joint	—	⑤	—	⑥	—
Double knuckle joint	⑦	—	⑧	—	⑩

No.	Appearance	No.	Appearance
①	Single clevis + Double clevis	⑥	Single knuckle joint + Double knuckle joint
②	Single clevis + Double knuckle joint	⑦	Double knuckle joint + Single clevis
③	Double clevis + Single clevis	⑧	Double knuckle joint + Single knuckle joint
④	Double clevis + Single knuckle joint	⑨	Double clevis + Clevis pivot bracket
⑤	Single knuckle joint + Double clevis	⑩	Double knuckle joint + Clevis pivot bracket

CJ1

CJP

CJ2

JCM

CM2

CM3

CG1

CG3

JMB

MB

**MB1**

CA2

CS1

CS2

D-□

-X□

Technical Data

# Square Tube Type Air Cylinder: Standard Type Double Acting, Double Rod

## MB1W Series

RoHS

ø32, ø40, ø50, ø63, ø80, ø100, ø125

### How to Order

**MB1W L 32 - 150 - Z -**

**With auto switch** **MDB1W L 32 - 150 - Z - M9BW -**

**With auto switch**  
(Built-in magnet)

**Mounting type**

B	Basic
L	Axial foot
F	Rod flange

\* Mounting bracket is shipped together with the product, but not assembled (except ø125).

**Bore size**

32	32 mm
40	40 mm
50	50 mm
63	63 mm
80	80 mm
100	100 mm
125	125 mm

**Port thread type**

Nil	Rc
TN	NPT
TF	G

**Cylinder stroke [mm]**  
Refer to "Standard Strokes" on page 451.

**Made to Order**  
For details, refer to page 451.

**Number of auto switches**

Nil	2 pcs.
S	1 pc.
3	3 pcs.
n	"n" pcs.

**Auto switch**

Nil	Without auto switch
-----	---------------------

\* For applicable auto switches, refer to the table below.

**Suffix (Cushion)**

Nil	Air cushion
N*	Rubber bumper

\* Since the bumpers are attached to the both sides of the piston for rubber bumper type, the overall length is longer than the cylinder with air cushion as follows: ø32, ø40: +6 mm, ø50, ø63: +8 mm, ø80, ø100: +10 mm, ø125: +12 mm.

**Suffix (Rod boot)**

Nil	None
J	Nylon tarpaulin (One end)
JJ	Nylon tarpaulin (Both ends)
K	Heat resistant tarpaulin (One end)
KK	Heat resistant tarpaulin (Both ends)

### Built-in Magnet Cylinder Model

If a built-in magnet cylinder without an auto switch is required, there is no need to enter the symbol for the auto switch.

(Example) MDB1WB40-100Z

### Applicable Auto Switches/Refer to pages 1575 to 1701 for further information on auto switches.

Type	Special function	Electrical entry	Indicator light	Wiring (Output)	Load voltage		Auto switch model		Lead wire length [m]					Pre-wired connector	Applicable load			
					DC	AC	Perpendicular	In-line	0.5 (Nil)	1 (M)	3 (L)	5 (Z)	IC circuit		Relay, PLC			
Solid state auto switch	—	Grommet	Yes	3-wire (NPN)	24 V	5 V, 12 V	—	M9NV	M9N	●	●	●	○	○	IC circuit	Relay, PLC		
				3-wire (PNP)				M9PV	M9P	●	●	○	○					
				2-wire				M9BV	M9B	●	●	●	○	○				
	3-wire (NPN)			M9NVV				M9NW	●	●	●	○	○					
	3-wire (PNP)			M9PVV				M9PW	●	●	●	○	○					
	2-wire			M9BVV				M9BV	●	●	●	○	○					
Water resistant (2-color indicator)	—	Grommet	Yes	3-wire (NPN)	24 V	5 V, 12 V	—	M9NAV <sup>*1</sup>	M9NA <sup>*1</sup>	○	○	●	○	○	IC circuit	—		
				3-wire (PNP)				M9PAV <sup>*1</sup>	M9PA <sup>*1</sup>	○	○	●	○	○				
				2-wire				M9BAV <sup>*1</sup>	M9BA <sup>*1</sup>	○	○	●	○	○				
Reed auto switch	—	Grommet	Yes	3-wire (NPN equivalent)	24 V	12 V	100 V or less	A96V	A96	●	—	●	—	—	—	—	IC circuit	—
				2-wire				A93V <sup>*2</sup>	A93	●	●	●	—	—	—	—		
			No	2-wire	24 V	12 V	100 V or less	A90V	A90	●	—	●	—	—	—	—	—	—

\*1 Water resistant type auto switches can be mounted on the above models, but in such case SMC cannot guarantee water resistance.

Please contact SMC regarding water resistant types with the above model numbers.

\*2 1 m type lead wire is only applicable to the D-A93.

\* Lead wire length symbols: 0.5 m ..... Nil (Example) M9NV  
1 m ..... M (Example) M9NWM  
3 m ..... L (Example) M9NWL  
5 m ..... Z (Example) M9NWX

\* Solid state auto switches marked with "○" are produced upon receipt of order.

\* Since there are other applicable auto switches than listed above, refer to page 461 for details.

\* For details about auto switches with pre-wired connector, refer to pages 1648 and 1649.

\* Auto switches are shipped together, (but not assembled).



# Square Tube Type Air Cylinder: Standard Type Double Acting, Double Rod **MB1W Series**



Symbol

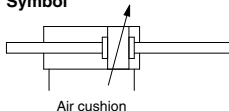

Air cushion

**Made to Order** Made to Order: Individual Specifications (For details, refer to page 462.)

Symbol	Specifications
-X846	Fastener strips mounted on switch mounting grooves

## Made to Order

[Click here for details](#)

Symbol	Specifications
-XA□	Change of rod end shape
-XB6	Heat resistant cylinder (−10 to 150°C) <sup>*1</sup> *2
-XC3	Special port location <sup>*3</sup>
-XC4	With heavy duty scraper <sup>*2</sup>
-XC5	Heat resistant cylinder (−10 to 110°C) <sup>*1</sup>
-XC7	Tie-rod, cushion valve, tie-rod nut, etc. made of stainless steel <sup>*2</sup>
-XC22	Fluororubber seal <sup>*2</sup>
-XC26	With split pins for double clevis pin/double knuckle joint pin and flat washers <sup>*4</sup>
-XC30	Rod trunnion <sup>*2</sup>
-XC35	With coil scraper <sup>*2</sup>
-XC65	Made of stainless steel (Combination of XC7 and XC68) <sup>*2</sup>
-XC68	Piston rod and rod end nut made of stainless steel <sup>*2</sup> (with hard chrome plated piston rod)

\*1 Air cushion only

\*2 Except ø125

\*3 The cover shape is the same as the current product.

\*4 ø125 only

For special port location (-XC3), the mounting bracket and port location can be determined using the standard product corresponding to the operating conditions. Also, this is only applicable to -XC3BB, -XC3CC and -XC3DD with trunnion bracket.

Refer to pages 460 and 461 for cylinders with auto switches.

- Auto switch proper mounting position (detection at stroke end) and its mounting height
- Minimum stroke for auto switch mounting
- Operating range
- Auto switch mounting brackets/Part no.

## Specifications

Bore size [mm]	32	40	50	63	80	100	125
<b>Action</b>	Double acting, Double rod						
<b>Fluid</b>	Air						
<b>Proof pressure</b>	1.5 MPa						
<b>Maximum operating pressure</b>	1.0 MPa						
<b>Minimum operating pressure</b>	0.05 MPa						
<b>Ambient and fluid temperature</b>	Without auto switch: −10 to 70°C (No freezing) With auto switch: −10 to 60°C (No freezing)						
<b>Lubrication</b>	Not required (Non-lube)						
<b>Piston speed</b>	50 to 1000 mm/s						50 to 700 mm/s
<b>Stroke length tolerance</b>	Up to 250: $^{+1.0}_0$ , 251 to 1000: $^{+1.4}_0$						
<b>Cushion</b> <sup>Note)</sup>	Air cushion or Rubber bumper						
<b>Port size (Rc, NPT, G)</b>	1/8	1/4	3/8		1/2		
<b>Mounting</b>	Basic, Axial foot, Rod flange						

Note) Kinetic energy absorbable by the cushion mechanism is identical to double acting, single rod.

## Standard Strokes

Bore size	Standard stroke		Max. manufacturable stroke
	Stroke range ①	Stroke range ②	
<b>32</b>	25, 50, 75, 100, 125, 150, 175, 200, 250, 300, 350, 400, 450, 500	Up to 1000	Up to 1800
<b>40</b>	25, 50, 75, 100, 125, 150, 175, 200, 250, 300, 350, 400, 450, 500		
<b>50</b>	25, 50, 75, 100, 125, 150, 175, 200, 250, 300, 350, 400, 450, 500, 600		
<b>63</b>	25, 50, 75, 100, 125, 150, 175, 200, 250, 300, 350, 400, 450, 500, 600		
<b>80</b>	25, 50, 75, 100, 125, 150, 175, 200, 250, 300, 350, 400, 450, 500, 600, 700, 800		
<b>100</b>	25, 50, 75, 100, 125, 150, 175, 200, 250, 300, 350, 400, 450, 500, 600, 700, 800		
<b>125</b>	25, 50, 75, 100, 125, 150, 175, 200, 250, 300, 350, 400, 450, 500, 600, 700, 800, 1000	Up to 2000	

Note 1) Intermediate strokes are available. (No spacer is used.)

Note 2) Applicable strokes should be confirmed according to the usage. For details, refer to "Air Cylinders Model Selection" on front matter pages. In addition, the products that exceed the stroke range ① might not be able to fulfill the specifications due to the deflection etc.

Note 3) Please consult with SMC for manufacturability and the part numbers when exceeding the stroke range ②.

Note 4) Using a stroke of a length which is smaller than the effective cushion length may result in reduced air cushion performance. Refer to "Technical Data 1" on page 1901 for details on the effective cushion length.

## Accessories

Standard	Mounting			
	Rod end nut	Basic	Axial foot	Rod flange
Option	Single knuckle joint	●	●	●
	Double knuckle joint (with pin)	●	●	●
	Rod boot	●	●	●

\* Refer to page 449 for part numbers and dimensions. (Refer to page 454 for rod boot.)

## Mounting Brackets/Part No.

Bore size [mm]	32	40	50	63	80	100	125
Axial foot	MB-L03	MB-L04	MB-L05	MB-L06	MB-L08	MB-L10	MB-L12
Rod flange	MB-F03	MB-F04	MB-F05	MB-F06	MB-F08	MB-F10	MB-F12

Note) Order two foots per cylinder.

## Rod Boot Material

Symbol	Rod boot material	Max. ambient temperature
<b>J</b>	Nylon tarpaulin	70°C
<b>K</b>	Heat resistant tarpaulin	110°C*

\* Max. ambient temperature for rod boot itself.

CJ1

CJP

CJ2

JCM

CM2

CM3

CG1

CG3

JMB

MB

MB1

CA2

CS1

CS2

D-□

-X□

Technical Data

# MB1W Series

## Theoretical Force



Bore size [mm]	Rod diameter [mm]	Operating direction	Piston area [mm <sup>2</sup> ]	Operating pressure [MPa]									
				0.2	0.3	0.4	0.5	0.6	0.7	0.8	0.9	1.0	
<b>32</b>	12	IN, OUT	691	138	207	276	346	415	484	553	622	691	
<b>40</b>	16	IN, OUT	1056	211	317	422	528	634	739	845	950	1056	
<b>50</b>	20	IN, OUT	1649	330	495	660	825	989	1154	1319	1484	1649	
<b>63</b>	20	IN, OUT	2803	561	841	1121	1402	1682	1962	2242	2523	2803	
<b>80</b>	25	IN, OUT	4536	907	1361	1814	2268	2722	3175	3629	4082	4536	
<b>100</b>	30	IN, OUT	7147	1429	2144	2859	3574	4288	5003	5718	6432	7147	
<b>125</b>	32	IN, OUT	11468	2294	3440	4588	5734	6881	8028	9174	10321	11468	

Note) Theoretical force [N] = Pressure [MPa] x Piston area [mm<sup>2</sup>]

## Weights

[kg]

Bore size [mm]		<b>32</b>	<b>40</b>	<b>50</b>	<b>63</b>	<b>80</b>	<b>100</b>	<b>125</b>	
Basic weight	Basic	0.59	0.81	1.43	1.71	3.18	4.38	6.68	
	Axial foot	0.71	0.95	1.65	1.99	3.68	5.04	8.76	
	Rod flange	0.88	1.18	1.88	2.50	4.63	6.21	10.86	
Additional weight per 50 mm of stroke		All mounting brackets	0.21	0.3	0.46	0.51	0.77	1.1	1.25

### Calculation

Example) **MB1WB32-100Z** (Basic, ø32, 100 stroke)

- Basic weight ..... 0.59 kg
- Additional weight ..... 0.21/50 stroke
- Cylinder stroke ..... 100 stroke

$$0.59 + 0.21 \times 100/50 = \mathbf{1.01 \text{ kg}}$$

## Construction

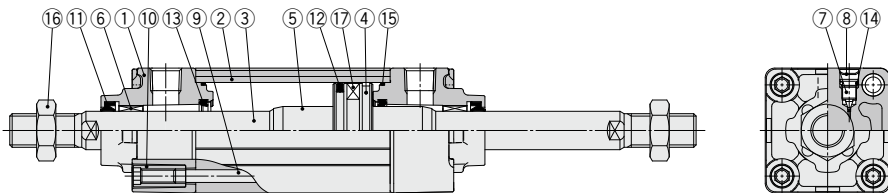

### Component Parts

No.	Description	Material	Q'ty	Note
1	Rod cover	Aluminum die-cast	2	Trivalent chromated
2	Cylinder tube	Aluminum alloy	1	Hard anodized
3	Piston rod	Carbon steel	1	Hard chrome plating
4	Piston	Aluminum alloy	1	
5	Cushion ring	Aluminum alloy	2	Anodized
6	Bushing	Bearing alloy	2	
7	Cushion valve	Steel wire	2	Trivalent zinc chromated
8	Retaining ring	Steel for spring	2	ø40 to ø125
9	Tie-rod	Carbon steel	4	Trivalent zinc chromated

No.	Description	Material	Q'ty	Note
10	Tie-rod nut	Carbon steel	8	Trivalent zinc chromated
11 <sup>5</sup>	Rod seal	NBR	2	
12 <sup>5</sup>	Piston seal	NBR	1	
13 <sup>5</sup>	Cushion seal	Urethane	2	
14	Cushion valve seal	NBR	2	
15 <sup>5</sup>	Cylinder tube gasket	NBR	2	
16	Rod end nut	Rolled steel	2	Trivalent zinc chromated
17	Magnet	—	(1)	

### Replacement Parts/Seal Kit

Bore size [mm]	Kit no.	Contents
32	MBW32Z-PS	Set of the nos. ⑪, ⑫, ⑬, ⑮
40	MB1W40Z-PS	
50	MB1W50Z-PS	
63	MB1W63Z-PS	
80	MB1W80Z-PS	
100	MB1W100Z-PS	
125	MBW125-PS	

\* Seal kits consist of items ⑪, ⑫, ⑬, ⑮, and can be ordered by using the seal kit number corresponding to each bore size.

\* The seal kit includes a grease pack (10 g for ø32 to ø50, 20 g for ø63 and ø80, 30 g for ø100).

Order with the following part number when only the grease pack is needed.

**Grease pack part number: GR-S-010** (10 g), **GR-S-020** (20 g)

CJ1

CJP

CJ2

JCM

CM2

CM3

CG1

CG3

JMB

MB

**MB1**

CA2

CS1

CS2

D-□

-X□

Technical  
Data

# MB1W Series

## Standard

### Basic: (B)

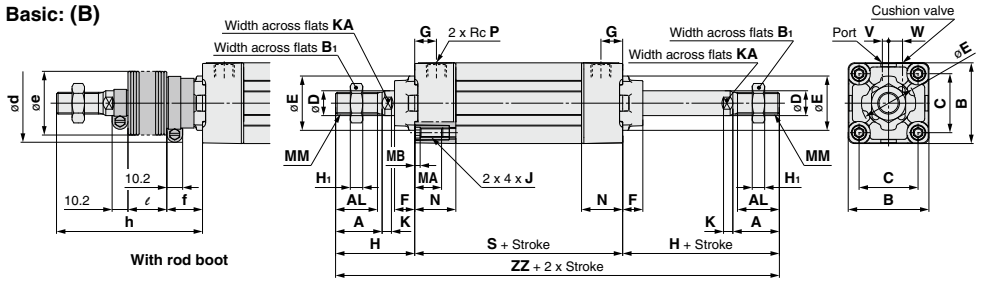

With rod boot

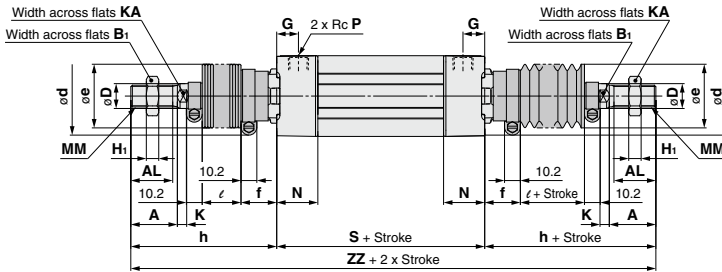

### Rubber Bumper

Bore size [mm]																				[mm]					
	A	AL	B	B <sub>1</sub>	C	D	E	F	G	H	H <sub>1</sub>	J	K	KA	MA	MB	MM	N	P	S*	V	W	ZZ*	S	ZZ
32	22	19.5	46	17	32.5	12	30	13	13	47	6	M6 x 1	6	10	16	4	M10 x 1.25	26	1/8	84	4	6.5	178	90	184
40	30	27	52	22	38	16	35	13	14	51	8	M6 x 1	6	14	16	4	M14 x 1.5	26	1/4	84	4	9	186	90	192
50	35	32	65	27	46.5	20	40	14	15.5	58	11	M8 x 1.25	7	18	16	5	M18 x 1.5	30.5	1/4	94	5	10.5	210	102	218
63	35	32	75	27	56.5	20	45	14	16.5	58	11	M8 x 1.25	7	18	16	5	M18 x 1.5	30.5	3/8	94	9	12	210	102	218
80	40	37	95	32	72	25	45	20	19	72	13	M10 x 1.5	10	22	16	5	M22 x 1.5	37	3/8	114	11.5	14	258	124	268
100	40	37	114	41	89	30	55	20	19	72	16	M10 x 1.5	10	26	16	5	M26 x 1.5	37	1/2	114	17	15	258	124	268
125	54	50	136	41	110	32	60	27	19	97	16	M12 x 1.75	13	27	20	6	M27 x 2	38	1/2	120	17	15	314	132	316

### With Rod Boot (Up to 1000 mm stroke)

Bore size [mm]	d	e	f	ℓ																	h											
				1 to 50	51 to 100	101 to 150	151 to 200	201 to 300	301 to 400	401 to 500	501 to 600	601 to 700	701 to 800	801 to 900	901 to 1000	1 to 50	51 to 100	101 to 150	151 to 200	201 to 300	301 to 400	401 to 500	501 to 600	601 to 700	701 to 800	801 to 900	901 to 1000					
32	54	36	23	12.5	25	37.5	50	75	100	125	150	175	200	225	250	73	86	98	111	136	161	186	211	236	261	286	311					
40	56	41	23	12.5	25	37.5	50	75	100	125	150	175	200	225	250	81	94	106	119	144	169	194	219	244	269	294	319					
50	64	51	25	12.5	25	37.5	50	75	100	125	150	175	200	225	250	89	102	114	127	152	177	202	227	252	277	302	327					
63	64	51	25	12.5	25	37.5	50	75	100	125	150	175	200	225	250	89	102	114	127	152	177	202	227	252	277	302	327					
80	68	56	29	12.5	25	37.5	50	75	100	125	150	175	200	225	250	101	114	126	139	164	189	214	239	264	289	314	339					
100	76	61	29	12.5	25	37.5	50	75	100	125	150	175	200	225	250	101	114	126	139	164	189	214	239	264	289	314	339					
125	82	75	27	10	20	30	40	60	80	100	120	140	160	180	200	120	130	140	150	170	190	210	230	250	270	290	310					

[mm]

Bore size [mm]	ZZ (Note)											
	1 to 50	51 to 100	101 to 150	151 to 200	201 to 300	301 to 400	401 to 500	501 to 600	601 to 700	701 to 800	801 to 900	901 to 1000
32	230	256	280	306	356	406	456	506	556	606	656	706
40	246	272	296	322	372	422	472	522	572	622	672	722
50	272	298	322	348	398	448	498	548	598	648	698	748
63	272	298	322	348	398	448	498	548	598	648	698	748
80	316	342	366	392	442	492	542	592	642	692	742	792
100	316	342	366	392	442	492	542	592	642	692	742	792
125	360	380	400	420	460	500	540	580	620	660	700	740

Note) ZZ indicates dimensions for double side rod boot.

\* Since the bumpers are attached to the both sides of the piston for rubber bumper type, the overall length is longer than the cylinder with air cushion as follows: ø32, ø40: +6 mm, ø50, ø63: +8 mm, ø80, ø100: +10 mm, ø125: +12 mm.

# Square Tube Type Air Cylinder: Standard Type Double Acting, Double Rod **MB1W Series**

## Standard/With Mounting Bracket

\* Dimensions not indicated are the same as the basic type, double acting, single rod (page 445).

### Axial foot: (L)

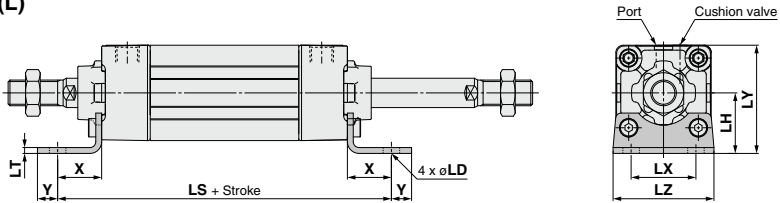

### Axial Foot

Bore size [mm]	X	Y	LD	LH	LS*	LT	LX	LY	LZ	LS
32	22	9	7	30	128	3.2	32	53	50	134
40	24	11	9	33	132	3.2	38	59	55	138
50	27	11	9	40	148	3.2	46	72.5	70	156
63	27	14	12	45	148	3.6	56	82.5	80	156
80	30	14	12	55	174	4.5	72	102.5	100	184
100	32	16	14	65	178	4.5	89	122	120	188
125	45	20	14	81	210	8	90	149	136	222

### Rubber Bumper

\* Since the bumpers are attached to the both sides of the piston for rubber bumper type, the overall length is longer than the cylinder with air cushion as follows: ø32, ø40: +6 mm, ø50, ø63: +8 mm, ø80, ø100: +10 mm, ø125: +12 mm.

### Rod flange: (F)

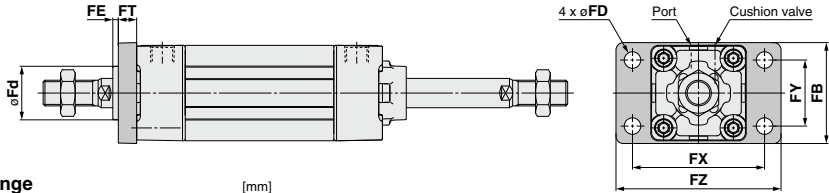

### Rod Flange

Bore size [mm]	FB	FD	FT	FX	FY	FZ	Fd
32	50	7	10	64	32	79	25
40	55	9	10	72	36	90	31
50	70	9	12	90	45	110	38.5
63	80	9	12	100	50	120	39.5
80	100	12	16	126	63	153	45.5
100	120	14	16	150	75	178	54
125	138	14	20	180	102	216	57.5

CJ1

CJP

CJ2

JCM

CM2

CM3

CG1

CG3

JMB

MB

**MB1**

CA2

CS1

CS2

D-□

-X□

Technical Data

# Square Tube Type Air Cylinder: Non-rotating Rod Type Double Acting, Single Rod

## MB1K Series



ø32, ø40, ø50, ø63, ø80, ø100

### How to Order

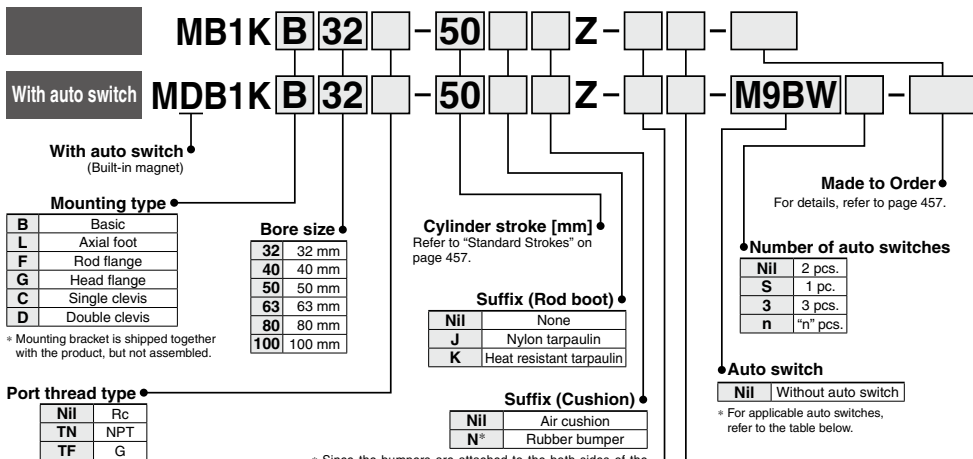

\* Mounting bracket is shipped together with the product, but not assembled.

**Port thread type**

Nil	Rc
TN	NPT
TF	G

\* Refer to "Ordering Example of Cylinder Assembly" on page 441.

\* Since the bumpers are attached to the both sides of the piston for rubber bumper type, the overall length is longer than the cylinder with air cushion as follows: ø32, ø40: +6 mm, ø50, ø63: +8 mm, ø80, ø100: +10 mm.

**Accessories 1**

Nil	No bracket
N	Pivot bracket

\* Only for D mounting type.  
\* Pivot bracket is shipped together with the product.  
\* Refer to page 448 for pivot bracket.

### Built-in Magnet Cylinder Model

If a built-in magnet cylinder without an auto switch is required, there is no need to enter the symbol for the auto switch.  
(Example) MDB1B40-100Z

### Applicable Auto Switches/Refer to pages 1575 to 1701 for further information on auto switches.

Type	Special function	Electrical entry	Indicator light	Wiring (Output)	Load voltage		Auto switch model		Lead wire length [m]					Pre-wired connector	Applicable load		
					DC	AC	Perpendicular	In-line	0.5 (Nil)	1 (M)	3 (L)	5 (Z)					
Solid state auto switch	Diagnostic indication (2-color indicator)	Grommet	Yes	3-wire (NPN)	24 V	5 V, 12 V	—	M9NV	M9N	●	●	○	○	IC circuit	Relay, PLC		
				3-wire (PNP)				M9PV	M9P	●	●	○	○				
				2-wire				M9BV	M9B	●	●	○	○				
	3-wire (NPN)			M9NVW				M9NW	●	●	○	○	IC circuit				
	3-wire (PNP)			M9PVW				M9PW	●	●	○	○					
	2-wire			M9BVW				M9BW	●	●	○	○					
Water resistant (2-color indicator)	Grommet	Yes	3-wire (NPN)	24 V	5 V, 12 V	—	—	M9NAV <sup>*1</sup>	M9NA <sup>*1</sup>	○	○	●	○	IC circuit	—		
			3-wire (PNP)					M9PAV <sup>*1</sup>	M9PA <sup>*1</sup>	○	○	●	○				
			2-wire					M9BAV <sup>*1</sup>	M9BA <sup>*1</sup>	○	○	○	○				
Feed auto switch	—	Grommet	No	3-wire (NPN equivalent)	24 V	12 V	—	A96V	A96	●	—	●	—	IC circuit	—		
				2-wire				100 V	A93V <sup>*2</sup>	A93	●	●	●			—	Relay, PLC
								100 V or less	A90V	A90	●	—	●			—	

\*1 Water resistant type auto switches can be mounted on the above models, but in such case SMC cannot guarantee water resistance.  
Please contact SMC regarding water resistant types with the above model numbers.  
\*2 1 m type lead wire is only applicable to the D-A93.  
\* Lead wire length symbols: 0.5 m ..... Nil (Example) M9NW  
1 m ..... M (Example) M9NWM  
3 m ..... L (Example) M9NLW  
5 m ..... Z (Example) M9NZL  
\* Solid state auto switches marked with "○" are produced upon receipt of order.  
\* Since there are other applicable auto switches than listed above, refer to page 461 for details.  
\* For details about auto switches with pre-wired connector, refer to pages 1648 and 1649.  
\* Auto switches are shipped together, (but not assembled).



# Square Tube Type Air Cylinder: Non-rotating Rod Type Double Acting, Single Rod **MB1K Series**



**Symbol**  
Air cushion

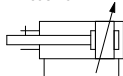

**Made to Order**  
Made to Order: Individual Specifications  
(For details, refer to page 462.)

Symbol	Specifications
-X846	Fastener strips mounted on switch mounting grooves

**Made to Order**

[Click here for details](#)

Symbol	Specifications
-XA□	Change of rod end shape
-XC3	Special port location*
-XC7	Tie-rod, cushion valve, tie-rod nut, etc. made of stainless steel
-XC8	Adjustable stroke cylinder/Adjustable extension type
-XC9	Adjustable stroke cylinder/Adjustable retraction type
-XC10	Dual stroke cylinder/Double rod type
-XC27	Double clevis and double knuckle joint pins made of stainless steel
-XC30	Rod truncation

\* The cover shape is the same as the current product.

For special port location (-XC3), the mounting bracket and port location can be determined using the standard product corresponding to the operating conditions. Also, this is only applicable to -XC3BB, -XC3CC and -XC3DD with trunnion bracket.

## Mounting Brackets/Part No.

Bore size [mm]	32	40	50
Axial foot (Note 1)	MB-L03	MB-L04	MB-L05
Rod/Head flange	MB-F03	MB-F04	MB-F05
Single clevis	MB-C03	MB-C04	MB-C05
Double clevis	MB-D03	MB-D04	MB-D05

Bore size [mm]	63	80	100
Axial foot (Note 1)	MB-L06	MB-L08	MB-L10
Rod/Head flange	MB-F06	MB-F08	MB-F10
Single clevis	MB-C06	MB-C08	MB-C10
Double clevis	MB-D06	MB-D08	MB-D10

Note 1) Order two foos per cylinder.

Note 2) Accessories for each mounting bracket are as follows.

Axial foot, Rod/Head flange, Single clevis/Body mounting bolt; Double clevis/Body mounting bolt, Clevis pin, Split pins and Flat washers. → Refer to page 449 for details.

Refer to pages 460 and 461 for cylinders with auto switches.

- Auto switch proper mounting position (detection at stroke end) and its mounting height
- Minimum stroke for auto switch mounting
- Operating range
- Auto switch mounting brackets/Part no.

## Specifications

Bore size [mm]	32	40	50	63	80	100
<b>Action</b>	Double acting, Single rod					
<b>Fluid</b>	Air					
<b>Proof pressure</b>	1.5 MPa					
<b>Maximum operating pressure</b>	1.0 MPa					
<b>Minimum operating pressure</b>	0.05 MPa					
<b>Ambient and fluid temperature</b>	Without auto switch: -10 to 70°C (No freezing) With auto switch: -10 to 60°C					
<b>Lubricant</b>	Non-lube					
<b>Piston speed</b>	50 to 1000 mm/s					
<b>Stroke length tolerance</b> (Note)	Up to 250: $^{+1.0}_0$ , 251 to 1000: $^{+1.4}_0$ , 1001 to 1500: $^{+1.8}_0$					
<b>Cushion</b>	Air cushion or Rubber bumper					
<b>Port size (Rc, NPT, G)</b>	1/8	1/4	3/8		1/2	
<b>Mounting</b>	Basic, Axial foot, Rod flange, Head flange, Single clevis, Double clevis					
<b>Non-rotating accuracy</b>	$\pm 0.5^\circ$			$\pm 0.3^\circ$		
<b>Allowable rotating torque</b> N·m or less	0.25	0.45	0.64		0.79	0.93

Note) Kinetic energy absorbable by the cushion mechanism is identical to double acting, single rod.

## Accessories

Mounting		Basic	Axial foot	Rod flange	Head flange	Single clevis	Double clevis
Standard	Rod end nut	●	●	●	●	●	●
	Clevis pin	—	—	—	—	—	●
Option	Single knuckle joint	●	●	●	●	●	●
	Double knuckle joint (with pin)	●	●	●	●	●	●
	Rod boot	●	●	●	●	●	●

\* Refer to page 449 for part numbers and dimensions. (Refer to page 445 for rod boot.)

## Standard Strokes

Bore size	Standard stroke [mm]
<b>32</b>	25, 50, 75, 100, 125, 150, 175, 200, 250, 300, 350, 400, 450, 500
<b>40</b>	25, 50, 75, 100, 125, 150, 175, 200, 250, 300, 350, 400, 450, 500
<b>50</b>	25, 50, 75, 100, 125, 150, 175, 200, 250, 300, 350, 400, 450, 500, 600
<b>63</b>	25, 50, 75, 100, 125, 150, 175, 200, 250, 300, 350, 400, 450, 500, 600
<b>80</b>	25, 50, 75, 100, 125, 150, 175, 200, 250, 300, 350, 400, 450, 500, 600, 700, 800
<b>100</b>	25, 50, 75, 100, 125, 150, 175, 200, 250, 300, 350, 400, 450, 500, 600, 700, 800

Note 1) Manufacture of intermediate strokes is possible.

(Spacers are not used.)

Note 2) Using a stroke of a length which is smaller than the effective cushion length may result in reduced air cushion performance. Refer to "Technical Data 1" on page 1901 for details on the effective cushion length.

## Rod Boot Material

Symbol	Material	Max. ambient temp.
<b>J</b>	Nylon tarpaulin	70°C
<b>K</b>	Heat resistant tarpaulin	110°C*

\* Max. ambient temperature for rod boot itself.

## Theoretical Force

OUT side is identical to double acting, single rod. Refer to the table below for IN side.

Bore size [mm]	Piston area [mm <sup>2</sup> ]	Bore size [mm]	Piston area [mm <sup>2</sup> ]
<b>32</b>	675	<b>63</b>	2804
<b>40</b>	1082	<b>80</b>	4568
<b>50</b>	1651	<b>100</b>	7223

Theoretical force [N] = Pressure [MPa] x Piston area [mm<sup>2</sup>]

CJ1

CJP

CJ2

JCM

CM2

CM3

CG1

CG3

JMB

MB

MB1

CA2

CS1

CS2

D-□

-X□

Technical Data

# MB1K Series

## Weights

Bore size [mm]		32	40	50	63	80	100
Basic weight	Basic	0.50	0.67	1.16	1.42	2.67	3.67
	Axial foot	0.62	0.81	1.38	1.70	3.17	4.33
	Rod/Head flange	0.79	1.04	1.61	2.21	4.12	5.50
	Single clevis	0.75	0.90	1.50	2.05	3.78	5.25
	Double clevis	0.76	0.94	1.59	2.21	4.07	5.52
Additional weight per 50 mm of stroke	All mounting brackets	0.16	0.20	0.34	0.39	0.57	0.72
	Single knuckle joint	0.15	0.23	0.26	0.26	0.60	0.83
Accessories	Double knuckle joint (with pin)	0.22	0.37	0.43	0.43	0.87	1.27

Calculation

Example) **MB1K32-100** (Basic, ø32, 100 stroke)

- Basic weight .....0.53 kg
- Additional weight .....0.16/50 stroke
- Cylinder stroke .....100 stroke

$$0.53 + 0.16 \times 100/50 = 0.85 \text{ kg}$$

## Construction

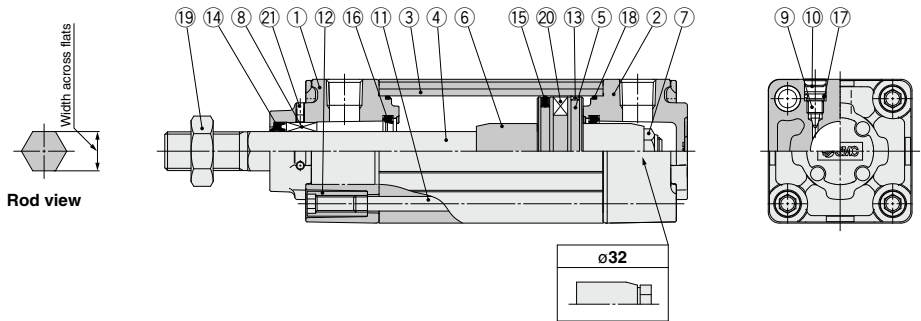

## Component Parts

No.	Description	Material	Q'ty	Note
1	Rod cover	Aluminum die-casted	1	Trivalent chromated
2	Head cover	Aluminum die-casted	1	Trivalent chromated
3	Cylinder tube	Aluminum alloy	1	Hard anodized
4	Piston rod	Stainless steel	1	
5	Piston	Aluminum alloy	1	
6	Cushion ring	Rolled steel	2	Zinc chromated
7	Piston nut	Rolled steel	1	Zinc chromated
8	Non-rotating guide	Bearing alloy	1	
9	Cushion valve	Steel wire	2	Trivalent zinc chromated
10	Retaining ring	Spring steel	2	ø40 to ø100
11	Tie-rod	Carbon steel	4	Trivalent zinc chromated

No.	Description	Material	Q'ty	Note
12	Tie-rod nut	Carbon steel	8	Trivalent zinc chromated
13	Wear ring	Resin	1	
14	Rod seal	NBR	1	
15	Piston seal	NBR	1	
16	Cushion seal	Urethane	2	
17	Cushion valve seal	NBR	2	
18	Cylinder tube gasket	NBR	2	
19	Rod end nut	Rolled steel	1	Trivalent zinc chromated
20	Magnet	—	(1)	
21	Hexagon socket head set screw	Steel wire	2	Trivalent black zinc chromated

## Replacement Parts/Seal Kit

Bore size [mm]	Kit no.	Contents
32	MBK32Z-PS	Set of the nos. ⑭, ⑮, ⑯, ⑰
40	MB1K40Z-PS	
50	MB1K50Z-PS	
63	MB1K63Z-PS	
80	MB1K80Z-PS	
100	MB1K100Z-PS	

\* Seal kits consist of items ⑭, ⑮, ⑯, ⑰, and can be ordered by using the seal kit number corresponding to each bore size.

\* The seal kit includes a grease pack (10 g for ø32 to ø50, 20 g for ø63 and ø80, 30 g for ø100).

Order with the following part number when only the grease pack is needed.

**Grease pack part number: GR-S-010** (10 g), **GR-S-020** (20 g)

\* Model without air cushion is designed to include rubber bumpers. Since the bumpers are attached to the both sides of the piston, the overall length is longer than the cylinder with air cushion as follows: ø32, ø40: +6 mm, ø50, ø63: +8 mm, ø80, ø100: +10 mm



# Square Tube Type Air Cylinder: Non-rotating Rod Type Double Acting, Single Rod **MB1K Series**

## Standard

Basic: (B)

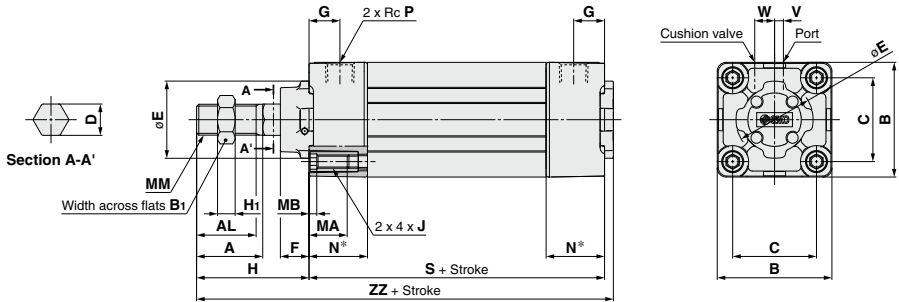

Bore size [mm]	Stroke range	A	AL	B	B <sub>1</sub>	C	D	E	F	G	H	H <sub>1</sub>	J	MA	MB	MM	N*	P	S	V	W	ZZ
<b>32</b>	Up to 500	22	19.5	46	17	32.5	12.2	30	13	13	47	6	M6 x 1	16	4	M10 x 1.25	26	1/8	84	4	6.5	135
<b>40</b>	Up to 500	30	27	52	22	38	14.2	35	13	14	51	8	M6 x 1	16	4	M14 x 1.5	26	1/4	84	4	9	139
<b>50</b>	Up to 600	35	32	65	27	46.5	19	40	14	15.5	58	11	M8 x 1.25	16	5	M18 x 1.5	30.5	1/4	94	5	10.5	156
<b>63</b>	Up to 600	35	32	75	27	56.5	19	45	14	16.5	58	11	M8 x 1.25	16	5	M18 x 1.5	30.5	3/8	94	9	12	156
<b>80</b>	Up to 800	40	37	95	32	72	23	45	20	19	72	13	M10 x 1.5	16	5	M22 x 1.5	37	3/8	114	11.5	14	190
<b>100</b>	Up to 800	40	37	114	41	89	27	55	20	19	72	16	M10 x 1.5	16	5	M26 x 1.5	37	1/2	114	17	15	190

The dimensions for each mounting type are the same as those for standard model (single rod). Refer to pages 446 to 448.

- CJ1**
- CJP**
- CJ2**
- JCM**
- CM2**
- CM3**
- CG1**
- CG3**
- JMB**
- MB**
- MB1**
- CA2**
- CS1**
- CS2**

- D-□**
- X□**
- Technical Data

# MB1 Series

# Auto Switch Mounting

## Auto Switch Proper Mounting Position (Detection at stroke end) and Its Mounting Height

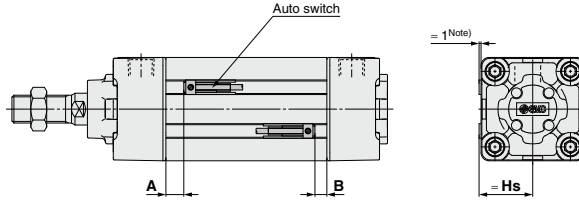

Auto Switch Proper Mounting Position

[mm]

Auto switch model	D-M9□ D-M9□V D-M9□W D-M9□WV D-M9□A D-M9□AV		D-A9□ D-A9□V		D-Y59□/Y69□ D-Y7P/Y7PV D-Y7□W/Y7□WV D-Y7BA D-Z7□/Z80	
	A	B	A	B	A	B
Bore size						
32	9.5	7.5	5.5	3.5	4.5	2.5
40	8.5	8	4.5	4	3.5	3
50	9	8.5	5	4.5	4	3.5
63	9	8.5	5	4.5	4	3.5
80	14	10.5	10	6.5	9	5.5
100	13.5	11	9.5	7	8.5	6
125	14.5	14.5	10.5	10.5	9.5	9.5

Note) Adjust the auto switch after confirming the operating conditions in the actual setting.

Auto Switch Proper Mounting Height

[mm]

Auto switch model	D-Y69□ D-Y7PV D-Y7□WV D-A9□V		D-M9□V D-M9□WV D-M9□AV	
	Hs	Hs	Hs	Hs
Bore size				
32	27		30	
40	30		33	
50	36		39	
63	41		44	
80	51		54	
100	60.5		63.5	
125	71.5		74.5	

Note) The above figures are for when the electrical entry perpendicular types D-A9□V/M9□V/ M9□W/M9□WV/ Y69□/Y7PV/Y7□WV are mounted.

## Minimum Stroke for Auto Switch Mounting

[mm]

Auto switch model	Number of auto switches	Bore size							
		32	40	50	63	80	100	125	
D-M9□ D-M9□V	With 2 pcs. (Different surfaces, Same surface)	10							
	With 1 pc.	10							
	With n pcs.	10 + 5 (n - 2)				10 + 10 (n - 2)			
D-M9□W D-M9□WV D-M9□A D-M9□AV	With 2 pcs. (Different surfaces, Same surface)	15				10			
	With 1 pc.	15				10			
	With n pcs.	15 + 10 (n - 2)				10 + 10 (n - 2)		10 + 15 (n - 2)	
D-A9□ D-A9□V	With 2 pcs. (Different surfaces, Same surface)	10							
	With 1 pc.	10							
	With n pcs.	10 + 10 (n - 2)		10 + 15 (n - 2)				15 + 20 (n - 2)	
D-Y59□/Y69□ D-Y7P/Y7PV	With 2 pcs. (Different surfaces, Same surface)	15				10			
	With 1 pc.	15				10			
	With n pcs.	15 + 10 (n - 2)		10 + 10 (n - 2)		10 + 15 (n - 2)		15 + 15 (n - 2)	
D-Y7□W D-Y7□WV	With 2 pcs. (Different surfaces, Same surface)	15				10			
	With 1 pc.	15				10			
	With n pcs.	15 + 10 (n - 2)		10 + 10 (n - 2)		10 + 15 (n - 2)		20 + 15 (n - 2)	
D-Y7BA	With 2 pcs. (Different surfaces, Same surface)	20				15			
	With 1 pc.	20				15			
	With n pcs.	20 + 10 (n - 2)		15 + 15 (n - 2)		20 + 15 (n - 2)			
D-Z7□ D-Z80	With 2 pcs. (Different surfaces, Same surface)	15							
	With 1 pc.	15							
	With n pcs.	15 + 15 (n - 2)				15 + 20 (n - 2)			

Note 1) n = 3, 4, 5 ...

Note 2) Center trunnion type is not included.

## Auto Switch Mounting Brackets/Part No.

Auto switch model	Bore size [mm]
	32 to 125
D-M9□/M9□V D-M9□W/M9□WV D-M9□A/M9□AV D-A9□/A9□V	Note) ① BMP1-032 ② BMG2-012
D-Y5□/Y7P D-Y7□W D-Y6□/Y7PV D-Y7□WV D-Y7BA D-Z7□/Z80	① BMP1-032

Note) Two kinds of auto switch mounting brackets are used as a set.

### D-M9□(V)/M9□W(V)/M9□A(V)/A9□(V)

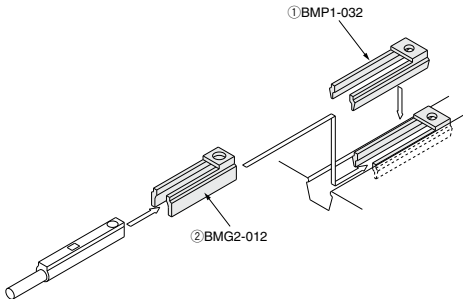

## Operating Range

Auto switch model	Bore size [mm]						
	32	40	50	63	80	100	125
D-M9□/M9□V D-M9□W/M9□WV D-M9□A/M9□AV	4	4.5	5	6	6	6	7
D-A9□/A9□V	7	7.5	8	9	9.5	10.5	12.5
D-Y59□/Y69□ D-Y7P/Y7PV D-Y7□W/Y7□WV D-Y7BA	5	4.5	5	5	6.5	7	7
D-Z7□/Z80	10	10	10	11	11	12	14

\* Values which include hysteresis are for guideline purposes only, they are not a guarantee (assuming approximately ±30% dispersion) and may change substantially depending on the ambient environment.

CJ1

CJP

CJ2

JCM

CM2

CM3

CG1

CG3

JMB

MB

**MB1**

CA2

CS1

CS2

### Other than the applicable auto switches listed in "How to Order", the following auto switches are mountable.

Refer to pages 1575 to 1701 for the detailed specifications.

Type	Model	Electrical entry	Features
Solid state	D-Y69A, Y69B, Y7PV	Grommet (Perpendicular)	—
	D-Y7NWV, Y7PWV, Y7BWV		Diagnostic indication (2-color indicator)
	D-Y59A, Y59B, Y7P	Grommet (In-line)	—
	D-Y7NW, Y7PW, Y7BW		Diagnostic indication (2-color indicator)
D-Y7BA	Grommet (In-line)	Water resistant (2-color indicator)	
D-Z73, Z76		—	
Reed	D-Z80	Grommet (In-line)	Without indicator light

\* With pre-wired connector is also available for solid state auto switches. For details, refer to pages 1648 and 1649.

\* Normally closed (NC = b contact) solid state auto switches (D-F9G/F9H/Y7G/Y7H) are also available. For details, refer to pages 1593 and 1595.

D-□

-X□

Technical Data



## 1 Fastener Strips Mounted on Switch Mounting Grooves

Symbol  
**-X846**

It prevents splashing water or windblown dust to the cylinder body from making an ingress into the auto switch mounting groove and accumulating.

### Applicable Series

Description	Model	Action	Note
Standard type	MB1	Double acting, Single rod	
	MB1W	Double acting, Double rod	
Non-rotating rod type	MB1K	Double acting, Single rod	

### How to Order

Standard model no. **- X846**

Fastener strips mounted on switch mounting grooves

**Specifications: Same as standard type**

### Dimensions (Dimensions other than below are the same as standard type.)

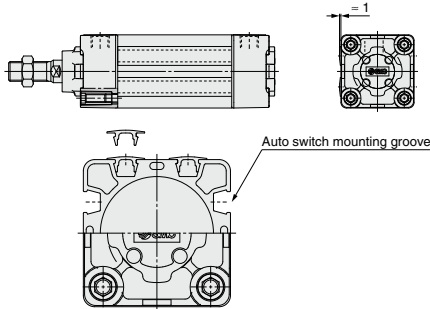

Sectional view

### Fastener Specifications

Quantity	8 pcs. (6 pcs. when auto switches are mounted) <sup>Note)</sup>
Material	Vinyl chloride
Color	White

Note) These cannot be installed on switch mounting grooves where auto switches have been mounted.



# MB1 Series

## Specific Product Precautions

Be sure to read this before handling the products. Refer to back page 50 for Safety Instructions and pages 3 to 12 for Actuator and Auto Switch Precautions.

### Adjustment

#### Warning

- Do not open the cushion valve beyond the stopper.**  
Crimping (ø32) or a retaining ring (ø40 to ø125) is provided to prevent the accidental removal of the cushion valve. Do not open the valve beyond the mechanism. If air is supplied, the cushion valve may shoot out from the cover.

Bore size [mm]	Cushion valve width across flats [mm]	Hexagon wrench
<b>32, 40</b>	2.5	JIS 4648 Hexagonal wrench key 2.5
<b>50, 63</b>	3	JIS 4648 Hexagonal wrench key 3
<b>80, 100, 125</b>	4	JIS 4648 Hexagonal wrench key 4

#### 2. Use the air cushion at the end of cylinder stroke.

Select the cylinder with bumper if the cushion valve is to be fully opened. Otherwise, tie-rods or piston assembly may be damaged.

#### 3. When replacing mounting brackets, use a hexagon wrench.

Bore size [mm]		Bolt	Width across flats [mm]	Tightening torque [N·m]
<b>32, 40</b>		MB-32-48-C1247	4	5.1
<b>50, 63</b>		MB-50-48-C1249	5	11
<b>80, 100</b>	Foot	MB-80-48AC1251	6	25
	Others	MB-80-48BC1251		
<b>125</b>	Foot	CE00008	8	30.1
	Others	CE00032		

#### 4. When replacing mounting brackets, tie-rod nuts on the cylinder body become loosened.

After retightening the tie-rod nuts with the proper tightening torque (Refer to Adjustment 3.), mount a mounting bracket.

### With Rod Boot

#### Handling

#### Caution

- Do not turn the piston rod with the rod boot kept locked.**

When turning the piston rod, loosen the band once and do not twist the rod boot.

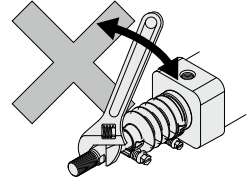

- Set the breathing hole in the rod boot downward or in the direction that prevents entry of dust or water content.**

CG1

CGP

CG2

JCM

CM2

CM3

CG1

CG3

JMB

MB

**MB1**

CA2

CS1

CS2

D-□

-X□

Technical Data