

Air Slide Table

MXJ Series

RoHS

Height: 10 mm/Width: 20 mm/Length: 43 mm (MXJ4)

Traveling parallelism: 0.005 mm

Note 1) Front mounting accuracy: 0.01 mm

Note 2) Top mounting accuracy: 0.03 mm

Integrated front mounting part and table result in a highly accurate and rigid top and front mounting surface.

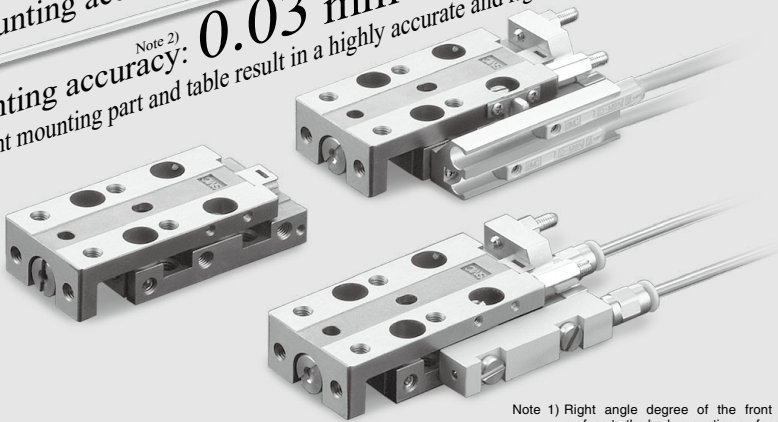

Note 1) Right angle degree of the front mounting surface to the body mounting surface

Note 2) Parallelism of the top mounting surface to the body mounting surface

M3 or M4 size screws are used for body mounting.

(Except for MXJ4 top mounting)
Prevents damage to the screws when mounting

Model	MXJ4	MXJ6	MXJ8
Threads for through-hole mounting on the top	M2.5	M3	M3
Threads for tap mounting on the bottom	M3	M4	M4

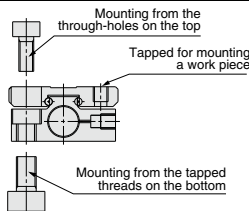

Auto switch mountable in two rows

- Auto switches can be mounted in two rows for all models in the range of **MXJ4 to MXJ8**.
- Two auto switches can be mounted with a 5 mm or longer stroke.



MXH

MXS

MXQ

MXQ

MXF

MXW

MXJ

MXP

MXY

MTS

D-

-X

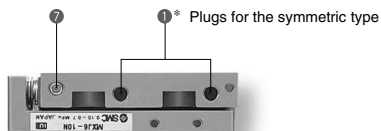

- ① Piping port
- ② Axial piping plate
- ③ Axial piping port
- ④ Retraction end stroke adjuster
- ⑤ Extension end stroke adjuster
- ⑥ Switch rail
- ⑦ Vacuum port (clean specifications)

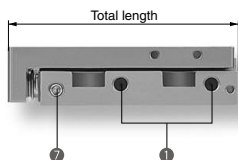
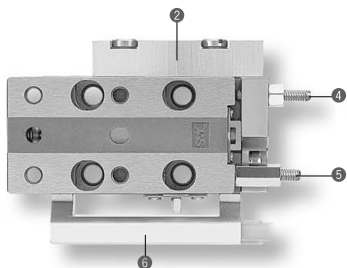
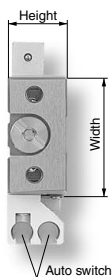

	(mm)		
Model	Total length	Width	Height
MXJ4	43	20	10
MXJ6	43	22	11
MXJ8	45	26	13

Note) Values of stroke 10 mm.

③ Axial Piping



Symmetric Type

Piping ports are provided both on the right and left sides. Switch rails and axial piping plates are interchangeable between the right and left side.

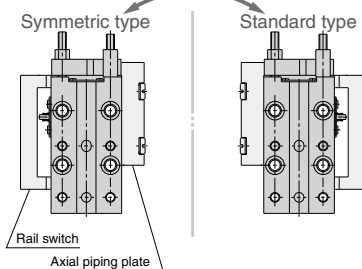

Variations

Model		Bore size (mm)	Standard stroke (mm)				Adjuster option			Piping option
Standard type	Symmetric type		5	10	15	20	Extension end	Retraction end	Both ends	Axial piping type
MXJ4	MXJ4L	4.5	●	●	—	—	●	●	●	●
MXJ6	MXJ6L	6	●	●	●	—	●	●	●	●
MXJ8	MXJ8L	8	●	●	●	●	●	●	●	●

Clean Specification

Clean specification products are available with no dimensional changes. The same options are available as for standard products.

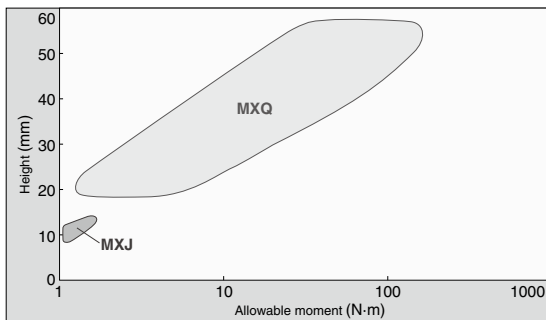
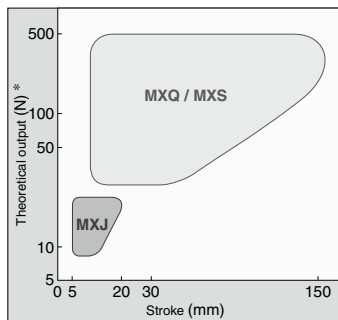

* Operating pressure: 0.5 MPa when operating direction is OUT.

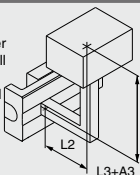
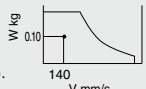
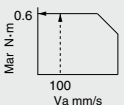
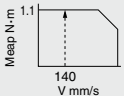
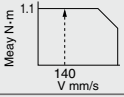

MXJ Series Model Selection

Procedure	Formula/Data	Selection Example
<p>1 Operating Conditions</p> <p>Enumerate the operating conditions considering the mounting position and workpiece configuration.</p>	<ul style="list-style-type: none"> • Model to be used • Type of cushion • Mounting orientation • Average operating speed V_a (mm/s) • Load mass W (kg) • Overhang (mm) 	<p>Cylinder: MXJ6-10 Cushion: Rubber bumper Mounting: Horizontal wall mounting Average operating speed : $V_a = 100$ mm/s Load mass: $W = 0.1$ kg $L_2 = 40$ mm $L_3 = 50$ mm</p> 
<p>2 Load Weight</p> <p>Find the collision speed V (mm/s).</p> <p>Confirm that the load mass W (kg) does not exceed the value in the graph.</p>	<p>$V = \frac{1.4 \cdot V_a}{\alpha}$ * Correction factor (Reference value)</p> <p>Graph (1)</p>	<p>$V = 1.4 \times 100 = 140$</p> <p>Confirm that $V = 140$ and $W = 0.1$ do not exceed the values in Graph (1).</p> <p>Applicable because it does not exceed the value in Graph (1).</p> 
<p>3 Load Factor</p>		
<p>3-1 Load Factor of Static Moment</p> <p>Find the static moment M (N·m).</p> <p>Find the allowable static moment M_a (N·m).</p> <p>Find the load factor of the static moment.</p>	<p>$M = W \times 9.8 (L_n + A_n)/1000$ Corrected value of moment center position distance A_n: Table (1)</p> <p>Pitch, Yaw moment: Graph (2) Roll moment: Graph (3)</p> <p>$\alpha_1 = M/M_a$</p>	<p>Examine M_r. $M_r = 0.1 \times 9.8(40 + 3)/1000 = 0.042$ $A_2 = 3$ Obtain $M_{ar} = 0.6$ from $V_a = 100$ in Graph (3).</p> <p>$\alpha_1 = 0.042/0.6 = 0.07$</p> 
<p>3-2 Load Factor of Dynamic Moment</p> <p>Find the dynamic moment Me (N·m).</p> <p>Find the allowable dynamic moment M_{ea} (N·m) from graph.</p> <p>Find the load factor of the dynamic moment.</p>	<p>$M_e = 1/3 \cdot W_e \times 9.8 (L_n + A_n)/1000$ mass equivalent to impact $W_e = \delta \cdot W \cdot V$ δ: Bumper coefficient Rubber bumper: 4/100 Metal stopper: 16/100 Corrected value of moment center position distance A_n: Table (1)</p> <p>Pitch, Yaw moment: Graph (2)</p> <p>$\alpha_2 = M_e/M_{ea}$</p>	<p>Examine M_{ep}. $M_{ep} = 1/3 \times 0.56 \times 9.8 \times (40+3)/1000 = 0.078$ $W_e = 4/100 \times 0.1 \times 140 = 0.56$ $A_3 = 3$ Obtain $M_{eap} = 1.1$ from $V = 140$ in Graph (2). $\alpha_2 = 0.078/1.1 = 0.07$</p> <p>Examine M_{ey}. $M_{ey} = 1/3 \times 0.56 \times 9.8 \times (50+11)/1000 = 0.116$ $W_e = 0.56$ $A_3 = 11$ Obtain $M_{eay} = 1.1$ from $V = 140$ in Graph (2). $\alpha_2' = 0.116/1.1 = 0.1$</p>  
<p>3-3 Sum of Load Factors</p> <p>Possible to use if the sum of the load factors does not exceed 1.</p>	<p>$\alpha_1 + \alpha_2 < 1$</p>	<p>$\alpha_1 + \alpha_2 + \alpha_2' =$ Applicable because $0.07 + 0.07 + 0.1 = 0.24 < 1$</p>

MXH

MXS

MXQ

MXQ

MXF

MXW

MXJ

MXP

MXV

MTS

D--X

MXJ Series

Fig. (1) Overhang: Ln (mm), Correction Value of Moment Center Position Distance: An (mm)

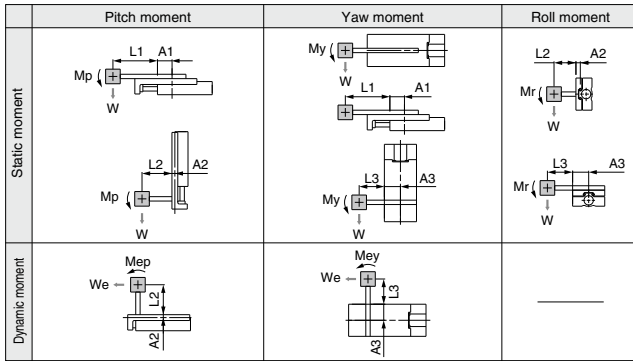

Note) Static moment: Moment generated by gravity
Dynamic moment: Moment generated by impact when colliding with stopper

Fig. (2) Allowable Static Load: F(N)

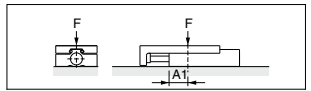

Graph (1) Load Mass: W

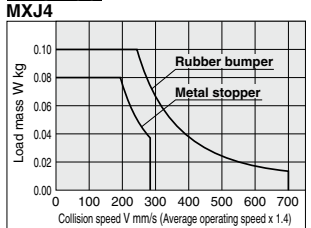

MXJ6

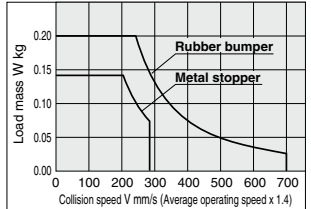

MXJ8

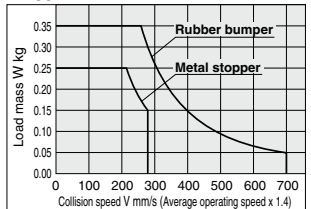

Graph (2) Allowable Moment
Pitch Moment: M_{ap}, M_{ep}
Yaw Moment: M_{ay}, M_{ey}

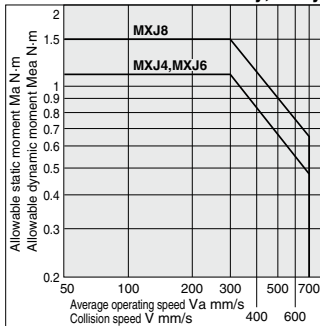

Note) Use the average operating speed when calculating static moment.
Use the collision speed when calculating dynamic moment. (Refer to page 307.)

Graph (3) Allowable Moment
Roll Moment: M_{ar}

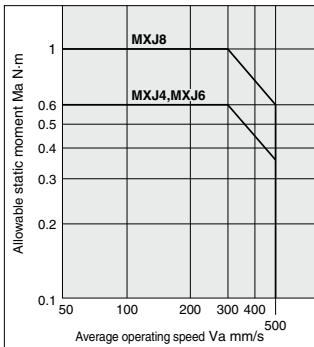

Table (2) Max. Allowable Load Mass: W_{max} (kg)

Model	Max. allowable load mass	
	Rubber bumper	Metal stopper
MXJ4	0.1	0.08
MXJ6	0.2	0.14
MXJ8	0.35	0.25

The above value represents the maximum value for each allowable load mass. For the maximum allowable load mass for each piston speed, please refer to Graph (1).

Table (1) Correction Value of Moment Center Position Distance: An (mm)

Model	Corrected value of moment center position distance (Refer to Fig. 2.)		
	A1	A2	A3
MXJ4	10	3	10
MXJ6	10	3	11
MXJ8	12	4	13

Table (3) Maximum Allowable Moment: M_{max} (N·m)

Model	Pitch/Yaw moment: M _{pm} max/M _{ym} max	Roll moment: M _{rm} max
MXJ4	1.1	0.6
MXJ6	1.1	0.6
MXJ8	1.5	1.0

The above value represents the maximum value of allowable moment. For the maximum allowable moment for each piston speed, please refer to Graph (2) and (3).

Symbol

Symbol	Definition	Unit	Symbol	Definition	Unit
An (n = 1 to 3)	Corrected value of moment center position distance	mm	F	Allowable static load	N
Ln (n = 1 to 3)	Overhang	mm	V	Collision speed (Average operating speed x 1.4)	mm/s
M (Mp, My, Mr)	Static moment (pitch, yaw, roll)	N·m	Va	Average operating speed	mm/s
Ma (Map, May, Mar)	Allowable static moment (pitch, yaw, roll)	N·m	W	Load mass	kg
Me (Mep, Mey)	Dynamic moment (pitch, yaw)	N·m	Wa	Mass equivalent to impact	kg
Mea (Meap, Meay)	Allowable dynamic moment (pitch, yaw)	N·m	Wmax	Max. allowable load mass	kg
Mmax (M _{pm} max, M _{ym} max, M _{rm} max)	Max. allowable moment (pitch, yaw, roll)	N·m	α	Load factor	—

Air Slide Table

MXJ Series

ø4, ø6, ø8

RoHS

How to Order

MXJ 6 - 10 - M9BW

• Symmetric type

Nil	Standard
L	Symmetric

• Functional option

Nil	Without option
P	Axial piping type

• Auto switch

Nil	Without auto switch (Built-in magnet)
-----	---------------------------------------

• Mode to Order
Refer to page 310 for details.

• Number of auto switches

Nil	2 pcs.
S	1 pc.
n	"n" pcs.

* For the applicable auto switch models, refer to the table below.

• Bore size (Standard stroke (mm))

Symbol	Bore size	Stroke
4	4.5	5, 10
6	6	5, 10, 15
8	8	5, 10, 15, 20

• Adjuster option

Nil	Without adjuster
CS	Metal stopper on extension end
CT	Metal stopper on retraction end
C	Metal stopper on both ends

• Switch rail

Nil	With magnet and switch rail
N	Without magnet and switch rail

(Note) Use an optional stepped positioning pin (see page 311) because the positioning pin hole of this product goes through.

Applicable Auto Switches/Refer to pages 1119 through to 1245 for further information on auto switches.

Type	Special function	Electrical entry	Indicator light	Wiring (Output)	Load voltage		Auto switch model		Lead wire length (m)				Pre-wired connector	Applicable load		
					DC	AC	Electrical entry direction		0.5 (Nil)	1 (M)	3 (L)	5 (Z)				
							Perpendicular	In-line								
Solid state auto switch	—	Grommet	Yes	3-wire(NPN)	5 V	24 V	—	M9NV	M9N	●	●	●	○	IC circuit	Relay, PLC	
				3-wire(PNP)	12 V			M9PV	M9P	●	●	●	○			
				2-wire	12 V			M9BV	M9B	●	●	●	○			
				3-wire(NPN)	5 V			F8N	—	●	—	●	○			IC circuit
				3-wire(PNP)	12 V			F8P		●	—	●	○			
				2-wire	12 V			F8B	●	—	●	○	—			
				3-wire(NPN)	5 V			M9NVW	M9NW	●	●	●	○			IC circuit
				3-wire(PNP)	12 V			M9PWW	M9PW	●	●	●	○			
				2-wire	12 V			M9BWW	M9BW	●	●	●	○			—
				3-wire(NPN)	5 V			M9NAV*1	M9NA*1	○	○	○	○			IC circuit
				3-wire(PNP)	12 V			M9PAV*1	M9PA*1	○	○	●	○			
				2-wire	12 V			M9BAV*1	M9BA*1	○	○	○	○			—
Reed auto switch	—	Grommet	Yes	3-wire (Equiv. to NPN)	5 V	—	—	A96V	A96	●	—	—	—	IC circuit	—	
				2-wire	12 V	100 V	A93V*2	A93	●	●	●	—	—	Relay, PLC		
				—	5 V, 12 V	100 V or less	A90V	A90	●	—	●	—	—	IC circuit		
				—	—	—	—	—	—	—	—	—	—	—		

*1 Water resistant type auto switches can be mounted on the above models, but in such case SMC cannot guarantee water resistance.

*2 1 m type lead wire is only applicable to D-A93.

* Lead wire length symbols: 0.5 m..... Nil (Example) M9NV
1 m..... M (Example) M9NWM
3 m..... L (Example) M9NWL
5 m..... Z (Example) M9NWZ

* Solid state auto switches marked with "○" are produced upon receipt of order.

* Refer to page 321 for applicable auto switches in addition to those listed above.

* For details on auto switches with a pre-wired connector, refer to page 1192 and 1193.

* Auto switches are shipped together (not assembled).

Caution

When an auto switch is not mounted properly, it can cause a malfunction. Refer to page 321 "Auto Switch Mounting".

Clean Series

11 - MXJ Standard model no.

• Clean Series

11: Vacuum type

* External dimensions are identical to the standard model.

Model

Model	Adjuster option	Grade	Intake flow L/min (ANR)*
11-MXJ4(L)	Without adjuster	Grade 3 (Class 100 or equivalent)	1
	Metal stopper	Grade 4 (Class 1000 or equivalent)	
11-MXJ6(L)	Without adjuster	Grade 3 (Class 100 or equivalent)	
	Metal stopper	Grade 4 (Class 1000 or equivalent)	
11-MXJ8(L)	Without adjuster	Grade 3 (Class 100 or equivalent)	
	Metal stopper	Grade 4 (Class 1000 or equivalent)	

* Reference value

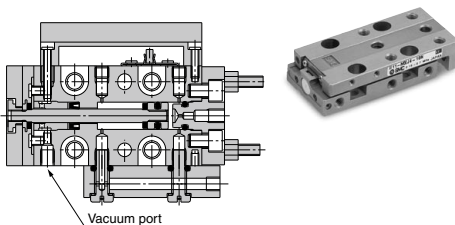

For details about the clean series, refer to "Pneumatic Clean Series" catalog (CAT.E02-23).

MXH

MXS

MXQ

MXQ

MXF

MXW

MXJ

MXP

MXY

MTS

D-□

X-□



Made to Order: Individual Specifications
(Refer to page 322 for details.)

Symbol	Specifications
-X39	Fluororubber seals
-X42	Anti-corrosive guide unit
-X45	EPDM seals

Specifications

Model	MXJ4	MXJ6	MXJ8
Bore size (mm)	4.5	6	8
Piping port size	M3 x 0.5		
Fluid	Air		
Action	Double acting		
Operating pressure	0.15 to 0.7 MPa		
Proof pressure	1.05 MPa		
Ambient and fluid temperature	-10 to 60°C		
Operating speed range (Average operating speed) ^{Note)}	50 to 500 mm/s (Metal stopper: 50 to 200 mm/s)		
Cushion	Rubber bumper (Metal stopper: Without cushion)		
Lubrication	Non-lube		
Stroke adjusting range (metal stopper)	Both ends each 0 to 5 mm		
Auto switch	Reed auto switch (2-wire, 3-wire) Solid state auto switch (2-wire, 3-wire) 2-color indicator solid state auto switch (2-wire, 3-wire)		
Stroke length tolerance	+1 0 mm		

Note) Average operating speed: Speed that the stroke is divided by a period of time from starting the operation to reaching the end.

Standard Stroke

Model	Standard stroke (mm)
MXJ4	5, 10
MXJ6	5, 10, 15
MXJ8	5, 10, 15, 20

Option

Adjuster option	Metal stopper	Extension end (CS)	Stroke adjustment range 0 to 5 mm
		Retraction end (CT)	
		Both ends (C)	
Functional option	Axial piping type (P)		Stroke adjuster is mountable on the axial piping.

Theoretical Output



Model	Bore size (mm)	Rod size (mm)	Operating direction	Piston area (mm ²)	Operating pressure (MPa)						(N)
					0.2	0.3	0.4	0.5	0.6	0.7	
MXJ4	4.5	2	OUT	16	3	5	6	8	10	11	
			IN	13	3	4	5	6	8	9	
MXJ6	6	3	OUT	28	6	8	11	14	17	20	
			IN	21	4	6	8	11	13	15	
MXJ8	8	4	OUT	50	10	15	20	25	30	35	
			IN	38	8	11	15	19	23	26	

Note) Theoretical output (N) = Pressure (MPa) x Piston area (mm²)

Moisture Control Tube IDK Series



When operating an actuator with a small diameter and a short stroke at a high frequency, the dew condensation (water droplet) may occur inside the piping depending on the conditions.

Simply connecting the moisture control tube to the actuator will prevent dew condensation from occurring. For details, refer to [the IDK series in the Best Pneumatics No. 6](#).

Weight

Basic Type (Without switch rail) MXJ□□-□□N (g)

Model	Standard stroke (mm)				Additional weight of adjuster option	
	5	10	15	20	Extension end	Retraction end
MXJ4	40	40	—	—	2	6
MXJ6	50	50	55	—	2	8
MXJ8	70	70	90	90	2	12

Axial Piping Type (Without switch rail) MXJ□□-□□PN (g)

Model	Standard stroke (mm)				Additional weight of adjuster option	
	5	10	15	20	Extension end	Retraction end
MXJ4	50	50	—	—	2	6
MXJ6	60	60	65	—	2	8
MXJ8	85	85	110	110	2	12

Additional Weight of Switch Rail (g)

Model	Standard stroke (mm)			
	5	10	15	20
MXJ4	5	5	—	—
MXJ6	5	5	6	—
MXJ8	5	5	7	7

Table Accuracy

B side parallelism to A side	0.03 mm
B side traveling parallelism to A side	0.005 mm
C side perpendicularity to A side	0.01 mm
M dimension tolerance	± 0.05 mm
Radial clearance (μm)	0 (Note)
Non-rotating table accuracy (deg)	0 (Note)

Note) In theory, radial clearance and non-rotating table accuracy are zero by the preloaded specification. However, in some actual cases, a moment can be applied and can cause deflection in an individual part. Therefore, refer to the table displacement amount on page 312.

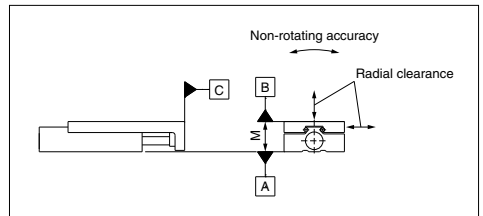

Optional Specifications

Rail assembly for mounting auto switch

When auto switch is mounted on air slide table without rail (MXJ□-□N), this assembly is used.

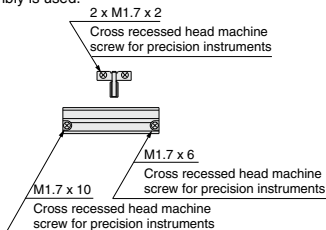

Applicable size	Switch rail part no.	Note
MXJ4-5	MXJ-AD4-10	With magnet and mounting screw
MXJ4-10		
MXJ6-5		
MXJ6-10	MXJ-AD6-10	
MXJ6-15		
MXJ8-5		
MXJ8-10	MXJ-AD6-10	
MXJ8-15		
MXJ8-20	MXJ-AD8-20	

Stepped positioning pin

MXJ-LP

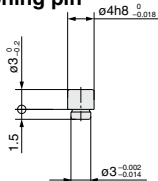

Use the optional stepped positioning pin that is provided because the positioning pin hole for the table is a through hole.

Stepped Positioning Pin

Part no.	Note
MXJ-LP	Common for all models

The graphs below show the table displacement when the static moment load is applied to the table. The graphs do not show the loadable mass. Refer to the Model Selection for the loadable mass.

Table Deflection (Reference Values)

Table displacement due to pitch moment load

Table displacement when loads are applied to the section marked with the arrow at the full stroke.

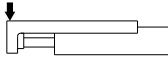

MXJ4

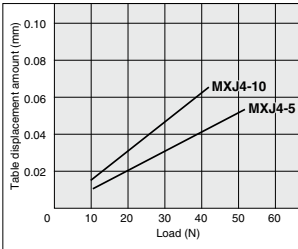

MXJ6

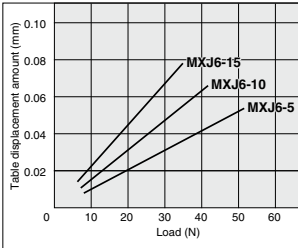

MXJ8

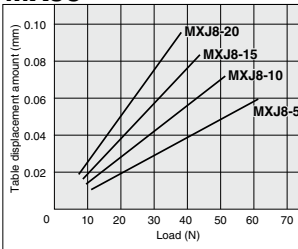
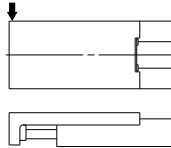
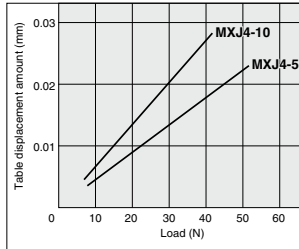

Table displacement due to yaw moment load

Table displacement when loads are applied to the section marked with the arrow at the full stroke.



MXJ4



MXJ6

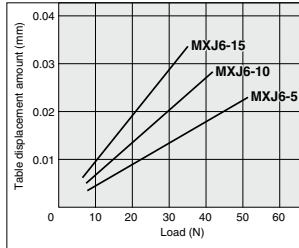

MXJ8

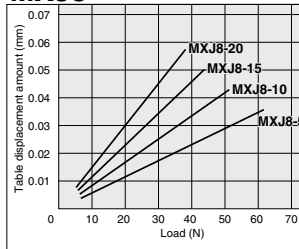
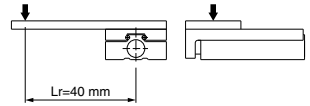
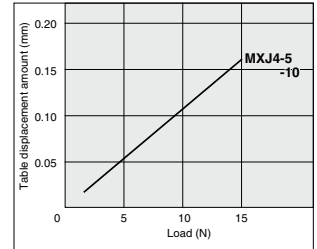

Table displacement due to roll moment load

Table displacement when loads are applied to the section marked with the arrow with the slide table retracted.



MXJ4



MXJ6

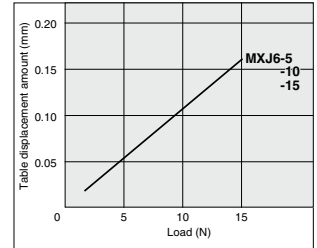

MXJ8

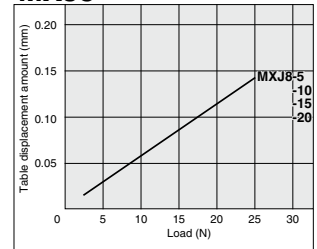

Dimensions Note) In the MXJ4, there is no change in total length by stroke.

Basic type (Without switch rail)

MXJ4-□□□N

Vacuum port M3 x 0.5 (Plugged when the product is a symmetric type.)
(Not plugged in the case of the clean series)

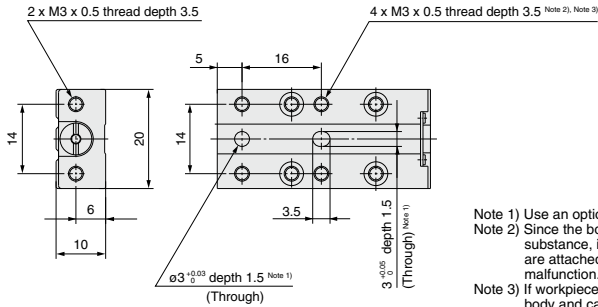
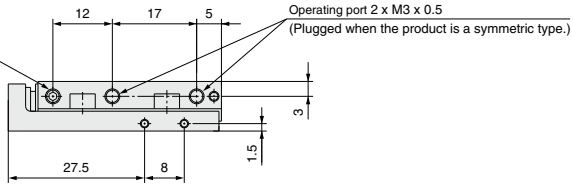

- Note 1) Use an optional stepped positioning pin. (See page 311.)
- Note 2) Since the body and table are constructed with a magnetic substance, it becomes magnetized when magnets, etc. are attached to them, and this may cause the auto switch malfunction.
- Note 3) If workpiece holding bolts are used, they can touch the body and cause malfunctions, etc. Refer to the Specific Product Precautions.

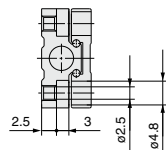
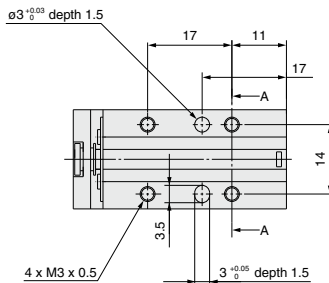
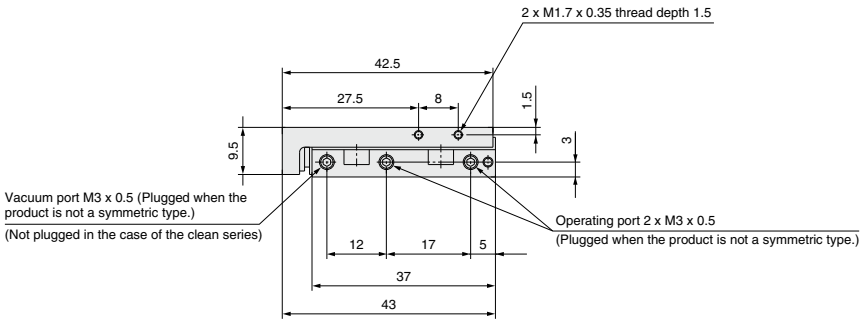

A-A

MXH
MXS
MXQ□
MXQ
MXF
MXW
MXJ
MXP
MXY
MTS

D-□
-X□

MXJ Series

Dimensions

With stroke adjuster

With adjuster on both ends MXJ4-□C□N

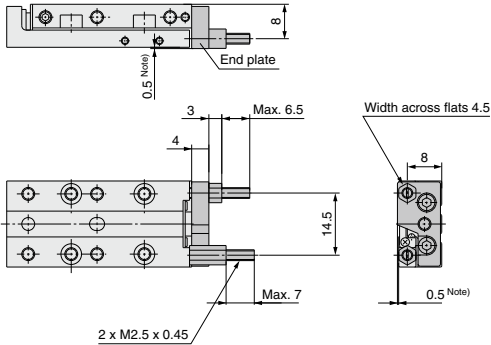

With adjuster on extension end MXJ4-□CSN

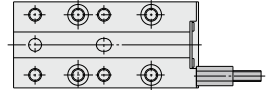

With adjuster on retraction end MXJ4-□CTN

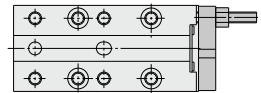

Note) Use caution because the height of the end plate's top surface will be higher than the table's top surface.

Axial piping

MXJ4-□□PN

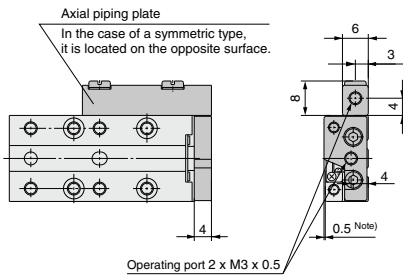

With switch rail

MXJ4

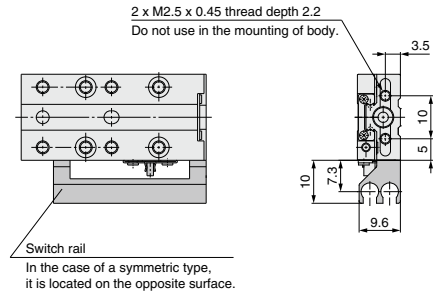

Note) Use caution because the height of the end plate's top surface will be higher than the table's top surface.

When all the available options are mounted (switch rail, stroke adjuster, with axial piping).

Standard type MXJ4-□CP

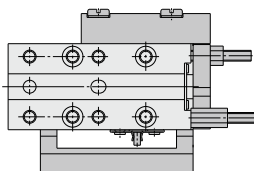

Symmetric type MXJ4L-□CP

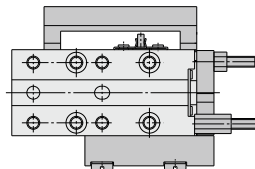

Dimensions

Basic type (Without switch rail)

MXJ6-□□□N

Vacuum port M3 x 0.5 (Plugged when the product is a symmetric type.)
(Not plugged in the case of the clean series)

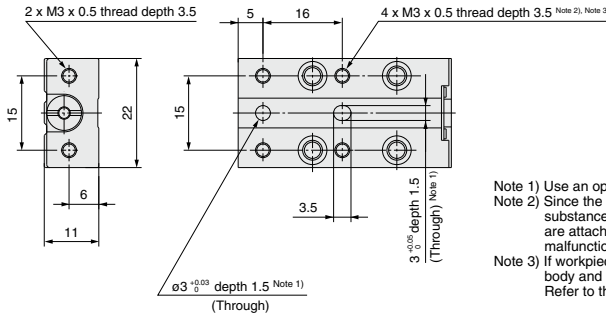
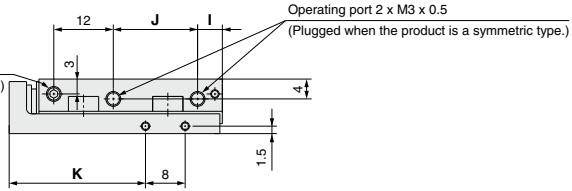

Note 1) Use an optional stepped positioning pin. (See page 311.)
Note 2) Since the body and table are constructed with a magnetic substance, it becomes magnetized when magnets, etc. are attached to them, and this may cause the auto switch malfunction.
Note 3) If workpiece holding bolts are used, they can touch the body and cause malfunctions, etc. Refer to the Specific Product Precautions.

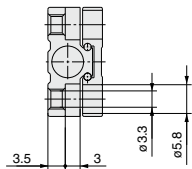
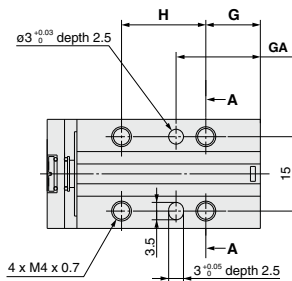
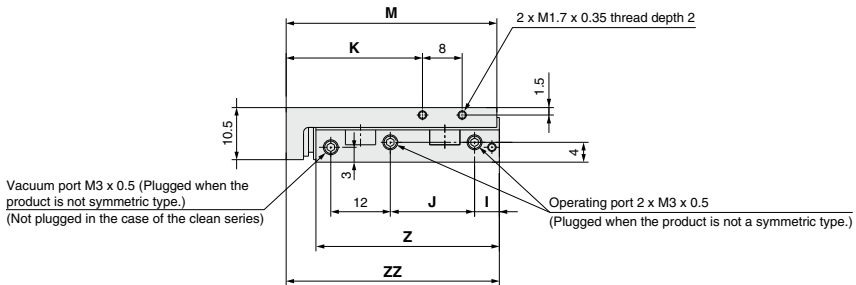

A-A

Model	G	GA	H	I	J	K	M	Z	ZZ
MXJ6-5	11	17	17	5	17	27.5	42.5	37	43
MXJ6-10	11	17	17	5	17	27.5	42.5	37	43
MXJ6-15	13	22	20	7	20	31.5	47.5	42	48

- MXH
- MXS
- MXQ□
- MXQ
- MXF
- MXW
- MXJ**
- MXP
- MXY
- MTS

- D-□
- X□

MXJ Series

Dimensions

**With stroke adjuster
With adjuster on both ends
MXJ6-□C□N**

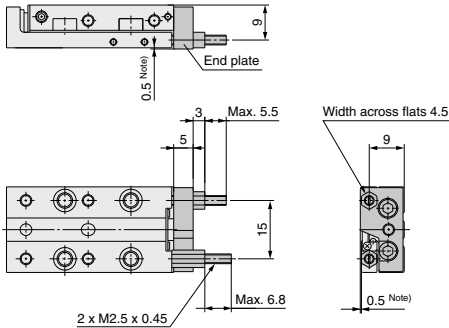

**With adjuster on extension end
MXJ6-□CS□N**

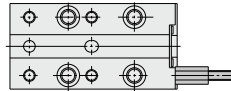

**With adjuster on retraction end
MXJ6-□□CTN**

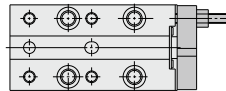

Note) Use caution because the height of the end plate's top surface will be higher than the table's top surface.

**Axial piping
MXJ6-□□PN**

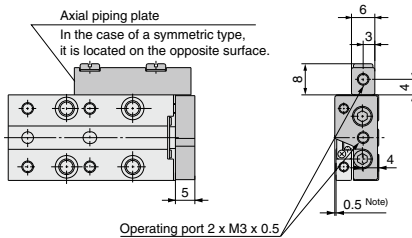

**With switch rail
MXJ6**

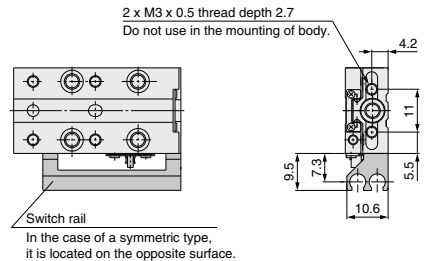

Note) Use caution because the height of the end plate's top surface will be higher than the table's top surface.

When all the available options are mounted (switch rail, stroke adjuster, with axial piping)

**Standard type
MXJ6-□CP**

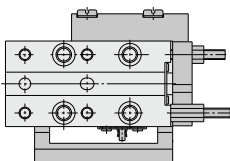

**Symmetric type
MXJ6L-□CP**

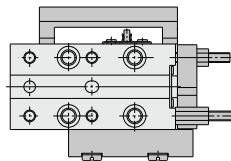

Dimensions

Basic type (Without switch rail)

MXJ8-□□□N

Vacuum port M3 x 0.5 (Plugged when the product is a symmetric type.)
(Not plugged in the case of the clean series)

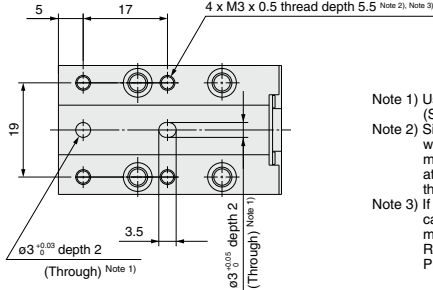
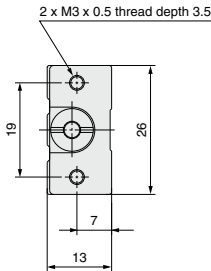
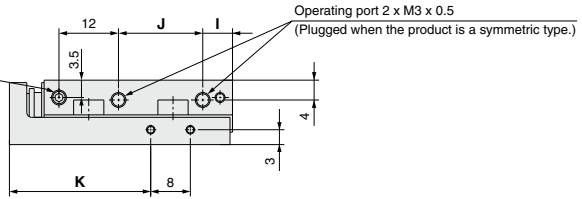

- Note 1) Use an optional stepped positioning pin. (See page 311.)
- Note 2) Since the body and table are constructed with a magnetic substance, it becomes magnetized when magnets, etc. are attached to them, and this may cause the auto switch malfunction.
- Note 3) If workpiece holding bolts are used, they can touch the body and cause malfunctions, etc. Refer to the Specific Product Precautions.

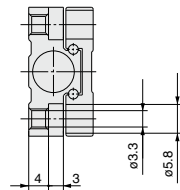
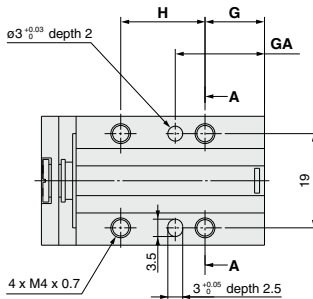
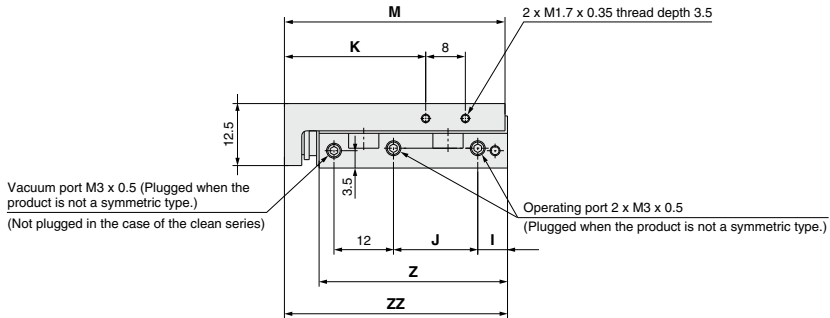

A-A

Model	G	GA	H	I	J	K	M	Z	ZZ
MXJ8-5	12	18	17	6	17	28.5	44.5	38	45
MXJ8-10	12	18	17	6	17	28.5	44.5	38	45
MXJ8-15	19	28	20	8	25	39.5	54.5	48	55
MXJ8-20	19	28	20	8	25	39.5	54.5	48	55

- MXH
- MXS
- MXQ□
- MXQ
- MXF
- MXW
- MXJ**
- MXP
- MXY
- MTS

- D-□
- X□

MXJ Series

Dimensions

With stroke adjuster
With adjuster on both ends
MXJ8-□C□N

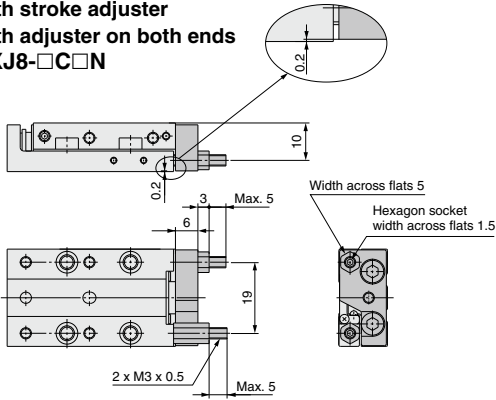

With adjuster on extension end
MXJ8-□CS□N

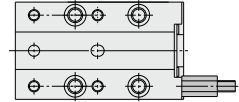

With adjuster on retraction end
MXJ8-□CTN

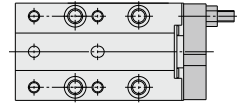

Axial piping
MXJ8-□□PN

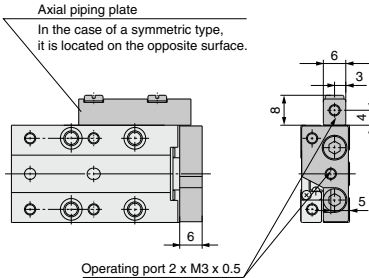

With switch rail
MXJ8

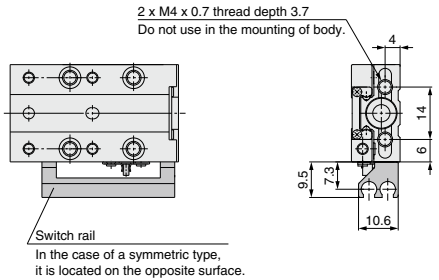

When all the available options are mounted (switch rail, stroke adjuster, with axial piping)

Standard type
MXJ8-□CP

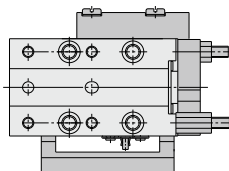

Symmetric type
MXJ8L-□CP

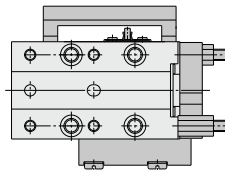

Construction

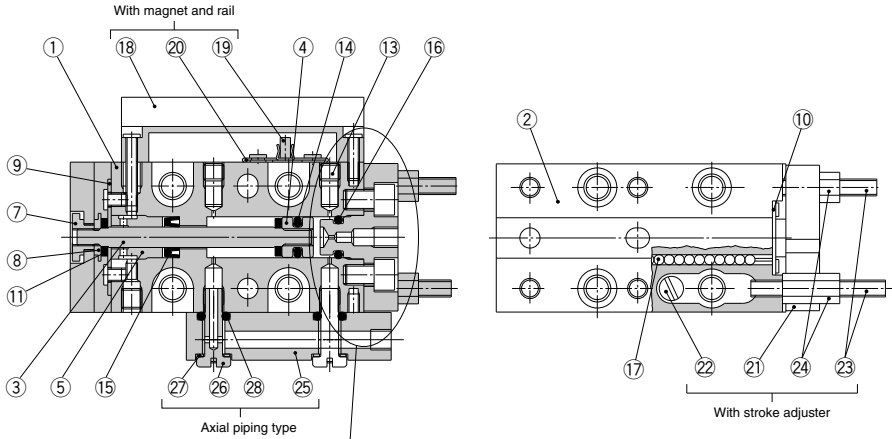

- MXH**
- MXS**
- MXQ** □
- MXQ**
- MXF**
- MXW**
- MXJ**
- MXP**
- MXY**
- MTS**

Component Parts

No.	Description	Material	Note
1	Body	Martensitic stainless steel <small>(Note)</small>	Heat treated
2	Table	Martensitic stainless steel <small>(Note)</small>	Heat treated
3	Rod	Stainless steel	
4	Piston	Brass	Electroless nickel plated
5	Rod cover	Resin	
6	Head cap	Resin	
7	Floating bushing A	Stainless steel	
8	Floating bushing B	Stainless steel	
9	Roller stopper A	Stainless steel	
10	Roller stopper B	Stainless steel	
11	Rod bumper	Polyurethane	
12	Plate	Stainless steel	
13	Plug	Steel + Fluorine	Zinc chromated
14	Piston seal	NBR	
15	Rod seal	NBR	
16	O-ring	NBR	
17	Steel balls	High carbon chrome bearing steel	

Note) Use caution because the martensitic stainless steel is inferior in corrosiveness when compared with austenitic stainless steel.

With Magnet, Rail

No.	Description	Material	Note
18	Switch rail	Aluminum alloy	Hard anodized
19	Magnet	—	
20	Magnet holder	Stainless steel	

With Stroke Adjuster

No.	Description	Material	Note
21	End plate	Stainless steel	
22	Stopper pin	Steel	Heat treated, Trivalent chromated
23	Adjustment bolt	Steel	Heat treated <small>(Note)</small> , Zinc chromated
24	Adjustment nut	Steel	Zinc chromated

Note) Only the MXJ8 series is heat treated.

Axial Piping Type

No.	Description	Material	Note
25	Axial piping plate	Aluminum alloy	Hard anodized
26	Stud	Brass	Electroless nickel plated
27	Gasket	Stainless steel + NBR	
28	O-ring	NBR	

- D** □
- X** □

Auto Switch Mounting

Auto Switch Proper Mounting Position (Detection at Stroke End)

- | | |
|----------------------------------|---|
| Reed auto switch
D-A9□ | Solid state auto switch
D-M9□
D-M9□W
D-M9□A |
|----------------------------------|---|

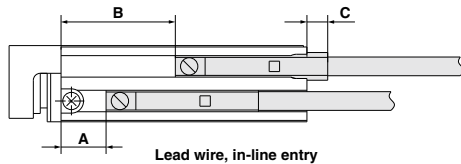

* Figures in the table above are used as a reference when mounting the auto switches for stroke end detection. In the case of actually setting the auto switches, adjust them after confirming their operation.

Reed Auto Switch: D-A9□ (mm)

Model	A				B				C			
	Stroke				Stroke				Stroke			
	5	10	15	20	5	10	15	20	5	10	15	20
MXJ4	9	4	—	—	14	14	—	—	0.5	0.5	—	—
MXJ6	9	4	3	—	14	14	18	—	0.5	0.5	-0.5	—
MXJ8	9	4	10	5	14	14	25	25	-0.5	-0.5	0.5	0.5

Solid State Auto Switch, 2-Color Indicator Solid State Auto Switch: D-M9□, D-M9□W, D-M9□A (mm)

Model	A				B				C			
	Stroke				Stroke				Stroke			
	5	10	15	20	5	10	15	20	5	10	15	20
MXJ4	13	8	—	—	18	18	—	—	4.5	4.5	—	—
MXJ6	13	8	7	—	18	18	22	—	4.5	4.5	3.5	—
MXJ8	13	8	14	9	18	18	29	29	3.5	3.5	4.5	4.5

- | | |
|-----------------------------------|---|
| Reed auto switch
D-A9□V | Solid state auto switch
D-M9□V
D-M9□WV
D-M9□AV
D-F8□ |
|-----------------------------------|---|

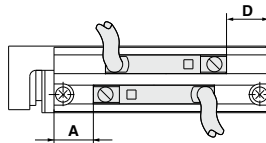

* Figures in the table above are used as a reference when mounting the auto switches for stroke end detection. In the case of actually setting the auto switches, adjust them after confirming their operation.

Reed Auto Switch: D-A9□V (mm)

Model	A				D			
	Stroke				Stroke			
	5	10	15	20	5	10	15	20
MXJ4	9	4	—	—	1.5	1.5	—	—
MXJ6	9	4	3	—	1.5	1.5	2.5	—
MXJ8	9	4	10	5	2.5	2.5	1.5	1.5

Solid State Auto Switch, 2-Color Indicator Solid State Auto Switch: D-M9□, D-M9□WV, D-M9□AV (mm)

Model	A				D			
	Stroke				Stroke			
	5	10	15	20	5	10	15	20
MXJ4	13	8	—	—	5.5	5.5	—	—
MXJ6	13	8	7	—	5.5	5.5	6.5	—
MXJ8	13	8	14	9	6.5	6.5	5.5	5.5

Solid State Auto Switch: D-F8□ (mm)

Model	A				D			
	Stroke				Stroke			
	5	10	15	20	5	10	15	20
MXJ4	11	6	—	—	3.5	3.5	—	—
MXJ6	11	6	5	—	3.5	3.5	4.5	—
MXJ8	11	6	12	7	4.5	4.5	3.5	3.5

Operating Range

Auto switch model	Applicable bore size (mm)		
	ø4	ø6	ø8
D-A9□/A9□V	4	4	4
D-F8□	2	2	2
D-M9□/M9□V D-M9□W/M9□WV D-M9□A/M9□AV	2	2.5	2.5

* Since the operating range is provided as a guideline including hysteresis, it cannot be guaranteed (assuming approximately ±30% dispersion). It may vary substantially depending on an ambient environment.

Auto Switch Mounting

⚠ Caution

Auto Switch Mounting Tool

- When tightening the auto switch mounting screw (included with auto switch), use a watchmaker's screwdriver with a handle about 5 to 6 mm in diameter.

Tightening Torque

Tightening Torque of Auto Switch Mounting Screw (N·m)

Auto switch model	Tightening torque
D-F8□ D-A9□(V)	0.10 to 0.20
D-M9□(V) D-M9□W(V)	0.05 to 0.15
D-M9□A(V)	0.05 to 0.10

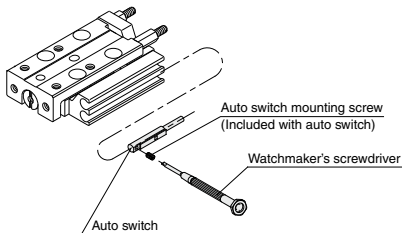

Caution on handling symmetric type

⚠ Caution

- Maintain a minimum space if standard type and symmetric type are used side by side.

If the space is insufficient, it may cause auto switches to malfunction.

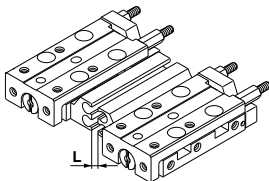

L Dimension

Without shielding plate	8 mm
With shielding plate	3 mm

Placing in the shield plate (0.2 to 0.3 mm iron plate) between the products allows the distance to be smaller.

When using the following solid state auto switches (D-M9□(V), M9□W(V), F8□), mount them in the illustrated direction. The lower slot is for extension end detection.

• Lead wire, in-line entry (D-M9□, M9□W, M9□A)

Extension end Retraction end

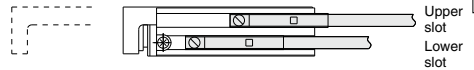

• Lead wire, perpendicular entry (D-M9□V, M9□WV, M9□AV, F8□)

Extension end Retraction end

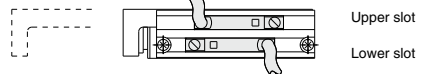

Other than the applicable auto switches listed in "How to Order", the following auto switches can be mounted.

* Normally closed (NC = b contact) solid state auto switches (D-F9G/F9H types) and a solid state auto switch (D-F8) are also available. Refer to pages 1136 and 1137 for details.

MXH

MXS

MXQ□

MXQ

MXF

MXW

MXJ

MXP

MXY

MTS

D-□

-X□



Please contact SMC for detailed dimensions, specifications and lead times.

1 Fluororubber Seal Symbol -X39

MXJ Standard model no. — X39
 ↓
 ● Fluororubber seal

Change the materials for the piston seal, rod seal and O-rings to fluororubber.

Specifications

Type	Fluororubber seal
Bore size (mm)	4.5, 6, 8
Seal material	Fluororubber

* Dimensions other than the above is the same as the standard type.

2 Anti-corrosive Specifications for Guide Unit Symbol -X42

MXJ Standard model no. — X42
 ↓
 ● Anti-corrosive specifications for guide unit

Martensitic stainless steel is used for the table and body. Use this treatment if more effective anti-corrosive measures are necessary. Anti-corrosive treatment is applied to the table and body.

Specifications

Type	Anti-corrosive guide unit
Bore size (mm)	4.5, 6, 8
Surface treatment	Special anti-corrosive treatment ⁽²⁾

* 1 Dimensions other than the above is the same as the standard type.

* 2 The special anti-corrosive treatment turns the table and body black.

3 EPDM Seal Symbol -X45

MXJ Standard model no. — X45
 ↓
 ● EPDM seal

Change the materials for the piston seal, rod seal and O-rings to EPDM.

Specifications

Type	EPDM seal
Bore size (mm)	4.5, 6, 8
Seal material	EPDM
Grease	PTFE grease

* Dimensions other than the above is the same as the standard type.

⚠ Warning

Precautions

Be aware that smoking cigarettes, etc. after your hands have come into contact with the grease used in this cylinder can create a gas that is hazardous to humans.



MXJ Series Specific Product Precautions 1

Be sure to read this before handling the products. Refer to back page 50 for Safety Instructions and pages 3 to 12 for Actuator and Auto Switch Precautions.

Selection

⚠ Caution

1. Operate loads within the range of the operating limits.

Select the model considering maximum loading weight and allowable moment. For details, refer to "Model Selection" on pages 307 and 308. When actuator is used outside of operating limits, eccentric loads on guide will be in excess of this causing vibration on guide, inaccuracy, and shortened life.

2. If intermediate stops by external stopper is done, avoid ejection.

If lurching occurs, damage can result. When making an intermediate stop with an external stopper to be followed by continued forward movement, first supply pressure to momentarily reverse the table, then retract the intermediate stopper, and finally apply pressure to the opposite port to operate the table again.

3. Do not use it in such a way that excessive external force or impact force could work on it.

This could result in damage.

Mounting

⚠ Caution

1. Do not scratch or dent on the mounting side of body, table and end plate.

The damage will result in a decrease in parallelism, vibration of guide and an increase in moving part resistance.

2. Do not scratch or dent on the forward side of the rail or guide.

This could result in looseness and increased operating resistance, etc.

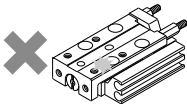

⚠ Caution

3. Do not apply excessive power and load when work is mounted.

If the external force more than the allowable moment were applied, looseness of the guide unit or increased operating resistance could take place.

4. Flatness of mounting surface should be 0.02 mm or less.

Poor parallelism of the workpiece mounted on the body, the base, and other parts can cause vibration in the guide unit and increased operating resistance, etc.

5. Select the proper connection with the load which has external support and/or guide mechanism on the outside, and align it properly.

6. Avoid contact with the body during operation.

Hands, etc. may get caught in the stroke adjuster. Install a cover as a safety measure if there are instances to be near the slide table during operation.

7. Keep away from objects which are influenced by magnets.

Since a body has magnets built-in, do not allow close contact with magnetic disks, magnetic cards or magnetic tapes. Data may be erased.

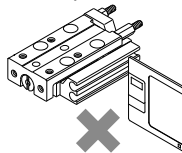

8. Do not attach magnets to the body and table section.

Since the body and table are constructed with a magnetic substance, it becomes magnetized when magnets, etc. are attached to them, and this may cause malfunction of auto switches, etc.

Mounting

9. When mounting the body, use appropriate length of screws and do not exceed the maximum tightening torque.

Tightening with a torque above the limit could malfunction. Whereas tightening insufficiently could result in misalignment or come to a drop.

1. Body tapped

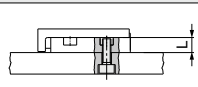

Model	Bolt	Maximum tightening torque (N·m)	Maximum screw-in depth L (mm)
MXJ4	M3 x 0.5	1.14	5
MXJ6	M4 x 0.7	2.7	6
MXJ8	M4 x 0.7	2.7	6

2. Through-hole

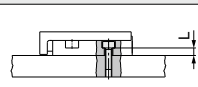

Model	Bolt	Maximum tightening torque (N·m)	L (mm)
MXJ4	M2.5 x 0.45	0.65	2.5
MXJ6	M3 x 0.5	1.14	3.5
MXJ8	M3 x 0.5	1.14	4

10. Use the below speed controllers and fittings.

If other speed controllers and fittings are used, they can interfere with the mounting surface.

Model	Side piping port	Axial piping port	Vacuum port
MXJ4	AS1200-M3	AS1200-M3	Miniature fittings M3 series
MXJ6	AS1200-M3	AS1201F-M3	
MXJ8	AS1201F-M3	AS1301F-M3	

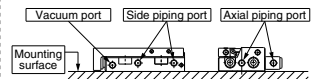

MXH

MXS

MXQ

MXQ

MXF

MXW

MXJ

MXP

MXY

MTS

D-□

-X□



MXJ Series

Specific Product Precautions 2

Be sure to read this before handling the products. Refer to back page 50 for Safety Instructions and pages 3 to 12 for Actuator and Auto Switch Precautions.

Mounting

⚠ Caution

1. Front mounting

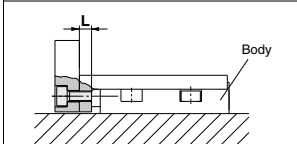

⚠ Caution To prevent the workpiece holding bolts from touching the guide block, use bolts that are at least shorter than the maximum screw-in depth. If longer bolts are used, they can touch the guide and cause a malfunction.

Model	Bolt	Maximum tightening torque (N·m)	Maximum screw-in depth L (mm)
MXJ4	M3 x 0.5	1.14	3.5
MXJ6	M3 x 0.5	1.14	3.5
MXJ8	M3 x 0.5	1.14	3.5

2. Top mounting

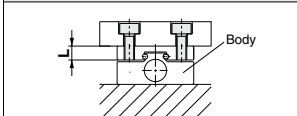

⚠ Caution To prevent the workpiece holding bolts from touching the guide block, use bolts that are at least shorter than the maximum screw-in depth. If longer bolts are used, they can touch the guide and cause a malfunction.

Model	Bolt	Maximum tightening torque (N·m)	Maximum screw-in depth L (mm)
MXJ4	M3 x 0.5	1.14	4
MXJ6	M3 x 0.5	1.14	4
MXJ8	M3 x 0.5	1.14	5.5

1. Use a stepped positioning pin that is provided optionally because the positioning pin hole for the table is through.

(Refer to page 311.)

Operating Environment

⚠ Caution

1. Do not use in an environment, where the product could be exposed to liquids such as cutting oil, etc.

Using in an environment where the product could be exposed to cutting oil, coolant, oil, etc. could result in looseness, increased operating resistance, air leakage, etc.

2. Do not use in an environment, where the product could be exposed directly to foreign materials such as powder dust, blown dust, cutting chips, spatter, etc.

This could result in looseness, increased operating resistance, air leakage, etc.

Contact us regarding use in this kind of environment.

3. Do not use in direct sunlight.

4. When there are heat sources in the surrounding area, block off them off.

When there are heat sources in the surrounding area, radiated heat may cause the product's temperature to rise and exceed the operating temperature range. Block off the heat with a cover, etc.

5. Do not subject it to excessive vibration and/or impact.

Contact us regarding use in this kind of environment, since this can cause damage or a malfunction.

6. Be careful about the corrosion resistance of the linear guide.

Be careful that the body and table use martensitic stainless steel, which is inferior to austenitic stainless steel in terms of corrosion resistance. Rust may result especially in an environment that allows water drops from condensation to stay on the surface.

Caution on Adjuster Option

Stroke Adjuster

⚠ Caution

1. Refer to the below table for lock nut tightening torque.

Insufficient torque will cause a decrease in the positioning accuracy.

Model	Thread size	Tightening torque (N·m)
MXJ4	M2.5 x 0.45	0.36
MXJ6	M2.5 x 0.45	0.36
MXJ8	M3 x 0.5	0.63

2. When stroke adjuster is adjusted, do not hit the table with a wrench, etc.

This could result in looseness.



MXJ Series Specific Product Precautions 3

Be sure to read this before handling the products. Refer to back page 50 for Safety Instructions and pages 3 to 12 for Actuator and Auto Switch Precautions.

Caution on replacing standard type to symmetric type, and vice versa

⚠ Caution

Switch rail, axial piping plate and port location can be changed symmetrically. In the event of replacing them, secure with the tightening torque below.

Thread	Thread size	Tightening torque (N·m)
Cross-recessed head machine screw	M1.7 x 0.35	0.1
Stud	M3 x 0.5	0.3
Dedicated plug	M3 x 0.5	0.3
Hexagon socket set screw	M3 x 0.5	0.3

* No need to applying sealant to the dedicated plug, and stud when exchanging.

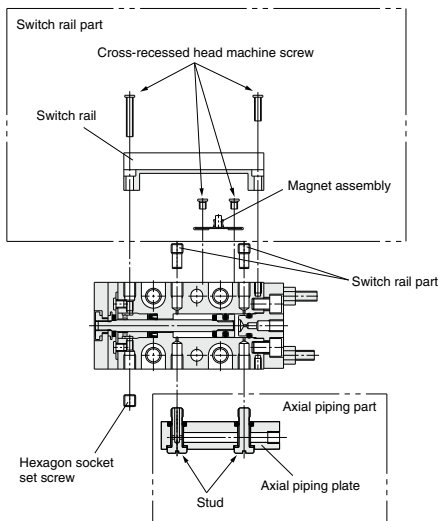

MXH

MXS

MXQ

MXQ

MXF

MXW

MXJ

MXP

MXY

MTS

D-□

-X□