

Compact Cylinder

CQS Series

ø12, ø16, ø20, ø25

Ideal for machine designs with small space requirements

The "D-M9" auto switch will not protrude from switch mounting groove.

Square body shape gives you flexibility for designing machine.

Cross-section of a cylinder tube is the same configuration regardless of w/ switch or w/o switch.

Auto switch mounting allows for flexible designing requirements

3 faces on ø12, ø16, and all 4 faces including port side on ø20, ø25.

2 way basic mounting: Through-hole or both ends tapped

Basic mounting is 2 way. You can choose either through-hole or both ends tapped mounting.

**Non-rotating accuracy
Non-rotating rod**

Hexagonal cross sectional shape piston rod for high non-rotation accuracy.

ø12, ø16 — ±1°
ø20, ø25 — ±0.7°

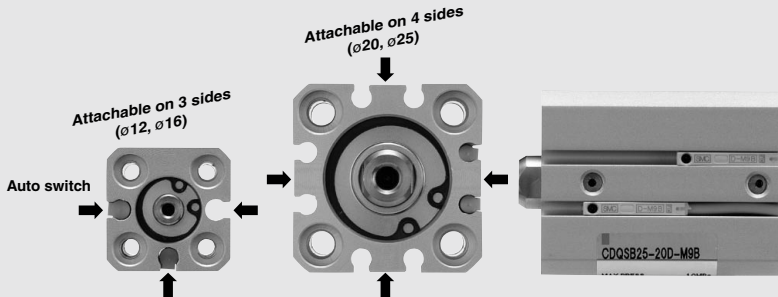

			Bore size (mm)	Stroke (mm)	Page
Standard 	Double acting	Single rod CQS	12, 16 20, 25	Standard stroke ø12 } 5, 10, 15, 20 ø16 } 25, 30 ø20 } 5, 10, 15, 20, 25 ø25 } 30, 35, 40, 45, 50	693
		Double rod CQSW		Long stroke ø12 } 35, 40, 45, 50, 75, 100 ø16 } 125, 150, 175, 200 ø20 } 75, 100, 125, 150, 175, 200 ø25 } 75, 100, 125, 150, 175, 200, 250, 300	
	Single acting	Return/Extend CQS		ø12 } 5, 10, 15, 20 ø16 } 25, 30 ø20 } 5, 10, 15, 20, 25 ø25 } 30, 35, 40, 45, 50	706
	Double acting	Single rod CQSK		ø12 } 5, 10 ø16 } 5, 10 ø20 } 5, 10 ø25 } 5, 10	714
Double rod CQSKW		ø12 } 5, 10, 15, 20 ø16 } 25, 30 ø20 } 5, 10, 15, 20, 25 ø25 } 30, 35, 40, 45, 50		724	
Anti-lateral Load 	Double acting	Single rod CQS□S		ø12 } 5, 10, 15, 20 ø16 } 25, 30 ø20 } 5, 10, 15, 20, 25 ø25 } 30, 35, 40, 45, 50	732
					ø12 } 5, 10, 15, 20 ø16 } 25, 30 ø20 } 5, 10, 15, 20, 25 ø25 } 30, 35, 40, 45, 50



Smooth cylinder (Low friction) CQSY

Refer to Best Pneumatics No. 2-3.



Low-speed cylinder CQSX

Refer to Best Pneumatics No. 2-3.

- CUJ
- CU
- CQS**
- JCQ
- CQ2
- RQ
- CQM
- CQU
- MU

- D-□
- X□
- Technical Data

Reduction of
installation
space

Added compact type foot brackets.

- Compact foot bracket has the same width as the cylinder.
Overall width reduced by up to **43%** (for $\phi 12$)

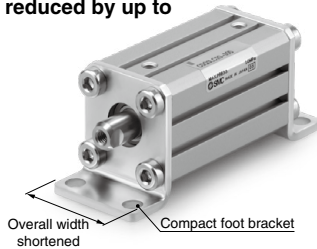

■ More compact installation space possible

- Short pitch mounting is possible.
- Allows installation close against a wall.

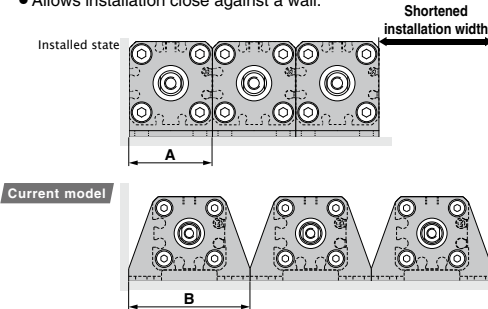

Bore size (mm)	Compact foot type width A (mm)	Current foot type width B (mm)	Reduced width for short pitch mounting (mm)		
			1 unit	2 units	3 units
12	25	44	19	38	57
16	29	48	19	38	57
20	36	62	26	52	78
25	40	66	26	52	78

* Short pitch mounting is possible only without auto switch.
Consult with SMC for mounting with auto switch.

■ Height from the bottom of brackets to the center of a cylinder is the same as the current model.

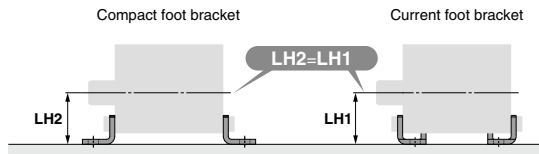

Applicable cylinders: C(D)QS, C(D)QSW, C(D)QS (Single acting, return/extend), C(D)QSK, C(D)QSKW (Non-rotating), C(D)QS□S (Anti-lateral load)

Reduction
in labor
for design

Added pivot brackets for double clevis.

■Rotating angle: Max. 100°

(For $\phi 12$, $\phi 16$)

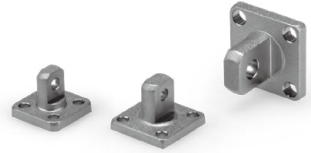

- Time to design rotating bracket saved.
- Improved amount of mounting freedom
- Can be mounted to an installed double clevis cylinder.

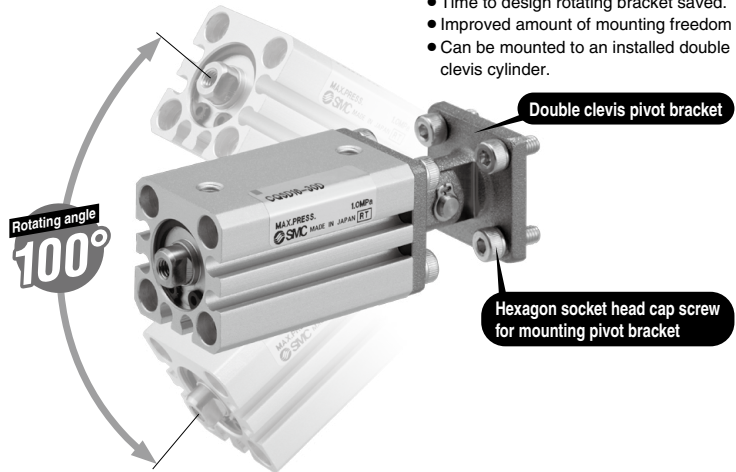

Applicable cylinders: CQS (Bore size $\phi 12$ to $\phi 25$, Mounting bracket, Applicable only to double clevis.)

CUJ

CU

CQS

JCQ

CQ2

RQ

CQM

CQU

MU

D-□

-X□

Technical
Data

Combinations of Standard Products and Made

CQS Series

- : Standard
- : Made to Order specifications
- : Special product (Contact SMC for details.)
- : Not available

Symbol	Specification	Applicable bore size	CQS (Standard)				
			Double acting		Single acting		
			Single rod	Double rod	Single rod/ Extension	Single rod/ Retraction	
			ø12 to ø25				
Standard	Standard	ø12 to ø25	●	●	●	●	
D	Built-in magnet		●	●	●	●	
CQS□-□M	Rod end male thread		●	●	●	●	
CQS□-□C	With rubber bumper		●	●	○	○	
CQS□-□F	With boss on head end		●	—	●	●	
CQS^F_g	Foot, Flange		●	●	●	●	
CQSD	Double clevis type		●	—	●	●	
10-, 11-	Clean series		●	○	○	○	
25A-	Copper (Cu) and zinc (Zn)-free ⁽⁵⁾		●	○	○	○	
20-	Copper ⁽⁴⁾ and Fluorine-free		●	●	●	●	
CQS□M	Cylinder with Stable Lubrication Function (Lube-retainer) ⁽⁶⁾		ø20 to ø25	●	○	○	○
XB6	Heat-resistant cylinder (-10 to 150 °C)		ø12 to ø25	○	○	○	○
XB7	Cold-resistant cylinder (-40 to 70 °C)			○	○	○	○
XB9	Low-speed cylinder (5 to 50 mm/s)	○		○	○	○	
XB10	Intermediate stroke (Using exclusive body)	○		○	○	○	
XB13	Low-speed cylinder (5 to 50 mm/s)	○		○	○	○	
XC6	Piston rod, retaining ring, rod end nut made of stainless steel	○		○	○	○	
XC8	Adjustable stroke cylinder/Adjustable extension type	○		—	○	○	
XC9	Adjustable stroke cylinder/Adjustable retraction type	○		—	○	○	
XC10	Dual stroke cylinder/Double rod type	○		—	○	○	
XC11	Dual stroke cylinder/Single rod type	○		—	○	○	
XC36	With boss on rod side	○		○	○	○	
XC85	Grease for food processing equipment	○		○	○	○	
XC92	Dust resistant cylinder	○		○	○	○	
X235	Change of piston rod end of double rod cylinder	—		○	—	—	
X271	Fluororubber seal	○		○	○	○	
X525	Long stroke of adjustable extension stroke cylinder (-XC8)	○		—	○	○	
X526	Long stroke of adjustable retraction stroke cylinder (-XC9)	○		—	○	○	
X633	Intermediate stroke of double rod type	—		○	—	—	
X636	Long stroke of dual stroke single rod	○		—	○	—	
X1876	With concave shape end boss on the cylinder tube head side	ø20, ø25		○	—	○	○

Note 1) A rubber bumper comes as standard.
 Note 2) For ø12 and ø16 only. (○) for ø20 and ø25.
 Note 3) Refer to Best Pneumatics No. 2-3 for low-speed cylinders.

Note 4) Copper-free for the externally exposed part. For details, refer to the **Web Catalog**.
 Note 5) For details, refer to the SMC website.
 Note 6) Only the products with an auto switch and without rubber bumper are compatible.

to Order Specifications

CQS Series

CQSK (Non-rotating rod)		CQS (Long stroke)		CQS□S (Anti-lateral load)		CQSY Smooth cylinder (Low friction) ⁽³⁾		CQSX Low-speed cylinder ⁽³⁾	
Double acting		Double acting		Double acting		Double acting		Double acting	
Single rod	Double rod	Single rod	Single rod	Single rod	Single rod	Single rod	Single rod	Single rod	Single rod
ø12 to ø25									
●	●	●	●	●	●	●	●		
●	●	●	●	●	●	●	●		
●	●	●	●	●	●	●	●		
○	○	● ⁽¹⁾	● ⁽¹⁾	● ⁽¹⁾	● ⁽¹⁾	● ⁽¹⁾	●		
●	—	○	●	●	○	○	○		
●	●	●	●	●	●	●	●		
●	—	●	●	●	●	●	●		
○	○	○	○	○	—	—	●		
○	○	●	●	●	○	○	○		
○	○	●	●	●	—	—	—		
—	—	○	○	○	○	○	○		
○	○	○	○	○	—	—	—		
○	○	○	○	○	—	—	—		
○	○	◎	◎	◎	○	○	○		
○	○	○	○	○	—	—	—		
◎	◎	◎	◎	◎	○	○	○		
◎	—	○	○	○	○	○	○		
◎	—	○	○	○	○	○	○		
◎	—	○	○	○	○	○	○		
○	○	◎ ⁽²⁾	◎ ⁽²⁾	◎ ⁽²⁾	◎ ⁽²⁾	◎ ⁽²⁾	◎ ⁽²⁾		
○	○	◎	◎	◎	—	—	—		
—	—	○	○	○	—	—	—		
—	○	—	—	—	—	—	—		
○	○	◎	◎	◎	—	—	—		
○	—	○	○	○	○	○	○		
○	—	○	○	○	○	○	○		
—	◎	—	—	—	—	—	—		
○	—	○	○	○	○	○	○		
◎	—	—	—	◎	○	○	—		

CUJ

CU

CQS

JCQ

CQ2

RQ

CQM

CQU

MU

D-□

-X□

Technical
Data



CQS Series Specific Product Precautions

Be sure to read this before handling the products. Refer to back page 50 for Safety Instructions and pages 3 to 12 for Actuator and Auto Switch Precautions.

Operating Precautions

⚠ Caution

- All loads to piston rod must be applied in axial direction only.
 - When a lateral load is applied unavoidably, ensure that it should not exceed the allowable lateral load to the rod end as specified in graph (1) to (5).
 - When installing a cylinder, centering should be required accurately.
 - Adoption of guide mechanism is strongly recommended for the case when CQS is used as stopper to prevent non-rotating piston rod from side loads.
- When a workpiece is secured to the end of the piston rod, ensure that the piston rod is retracted entirely, and place a wrench on the portion of the rod that protrudes beyond the section. Also, tighten by giving consideration to prevent the tightening torque from being applied to the non-rotating guide.

Retaining Ring Installation/Removal

⚠ Caution

- For installation and removal, use an appropriate pair of pliers (tool for installing a type C retaining ring).
- Even if a proper plier (tool for installing type C retaining ring) is used, it is likely to inflict damage to a human body or peripheral equipment, as a retaining ring may be flown out of the tip of a plier (tool for installing a type C retaining ring). Be much careful with the popping of a retaining ring. Besides, be certain that a retaining ring is placed firmly into the groove of rod cover before supplying air at the time of installment.

Allowable Lateral Load at Rod End

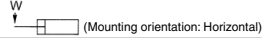

**Graph (1) Standard:
Non-rotating Rod Type/Without Auto Switch**

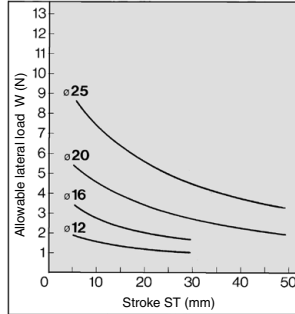

**Graph (2) Standard:
Non-rotating Rod Type/With Auto Switch**

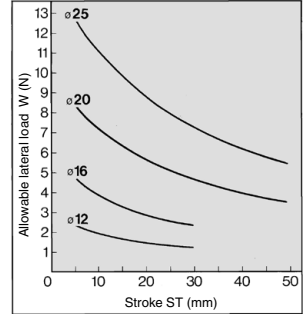

**Graph (3)
Anti-lateral Load Type/Without Auto Switch**

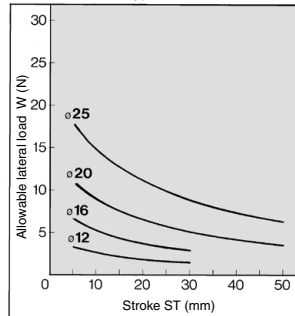

**Graph (4)
Anti-lateral Load Type/With Auto Switch**

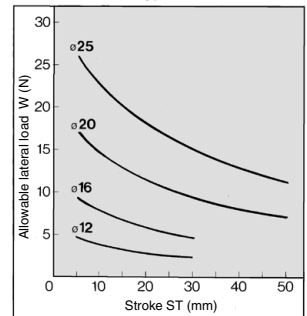

**Graph (5)
Long Stroke/With & Without Auto Switch**

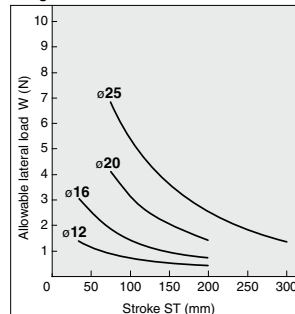

Note 1) Graph (1) to (5): Rod end female thread

Note 2) Lateral load allowance varies depending upon rod end shape dimensions or load value (distance to the center of the gravity of load). Please consult with SMC.

Compact Cylinder: Standard Type Double Acting, Single Rod CQS Series

ø12, ø16, ø20, ø25

How to Order

With auto switch CQDS B 20-30 D [] - [] - M9BW [] - []

With auto switch (Built-in magnet)
Mounting type
Bore size
Number of auto switches
Auto switch
Body option
Action

Made to Order
Refer to page 694 for details.

Mounting type

B	Through-hole/Both ends tapped common (Standard)
L	Foot type
LC	Compact foot type
F	Rod side flange type
G	Head side flange type
D	Double clevis type

Bore size

12	12 mm
16	16 mm
20	20 mm
25	25 mm

Number of auto switches

NII	2 pcs.
S	1 pc.
n	"n" pcs.

Auto switch

NII	Without auto switch
-----	---------------------

Body option

<Standard stroke>

NII	Standard
C	With rubber bumper
M	Rod end male thread
F	Boss on head end

<Long stroke>

C	With rubber bumper Rod end female thread (Standard)
CM	With rubber bumper Rod end male thread

Action

D	Double acting
---	---------------

Built-in Magnet Cylinder Model

If a built-in magnet cylinder without an auto switch is required, there is no need to enter the symbol for the auto switch.
(Example) CDQSL25-30D

Cylinder stroke (mm)

Bore size	Standard stroke	Long stroke
12, 16	5, 10, 15, 20, 25, 30	35, 40, 45, 50, 75, 100, 125, 150, 175, 200
20	5, 10, 15, 20, 25, 30, 35, 40, 45, 50	75, 100, 125, 150, 175, 200, 250, 300
25		75, 100, 125, 150, 175, 200, 250, 300

For "Manufacture of Intermediate Strokes", refer to page 694.

Applicable Auto Switches

Refer to pages 1575 to 1701 for further information on auto switches.

Type	Special function	Electrical entry	Indicator light	Wiring (Output)	Load voltage		Auto switch model		Lead wire length (m)					Pre-wired connector	Applicable load
					DC	AC	Perpendicular	In-line	0.5 (NII)	1 (M)	3 (L)	5 (Z)			
Solid state auto switch	—	Grommet	Yes	3-wire (NPN)	24 V	—	M9NV	M9N	●	●	●	●	○	IC circuit	
				3-wire (PNP)			M9PV	M9P	●	●	●	●	○		
				2-wire			M9BV	M9B	●	●	●	●	○		—
				3-wire (NPN)			M9NWV	M9NW	●	●	●	●	○		IC circuit
	3-wire (PNP)	M9BWW	M9BW	●	●	●	●	○	—						
	Water resistant (2-color indicator)	Grommet	Yes	3-wire (NPN)	24 V	—	M9NAV ^{*1}	M9NA ^{*1}	○	○	●	●	○	IC circuit	
				3-wire (PNP)			M9PAV ^{*1}	M9PA ^{*1}	○	○	●	●	○		
				2-wire			M9BAV ^{*1}	M9BA ^{*1}	○	○	●	●	○		—
2-wire (Non-polar)				—			P3DWA ^{**}	●	●	●	●	○	—		
Reed auto switch	—	Grommet	Yes	3-wire (NPN equivalent)	24 V	12 V	A96V	A96	●	—	●	—	—	IC circuit	—
				2-wire			A93V ^{**2}	A93	●	●	●	●	—		
			No	2-wire			A90V	A90	●	—	●	—	—	IC circuit	

*1 Water resistant type auto switches can be mounted on the above models, but in such case SMC cannot guarantee water resistance.

Consult with SMC regarding water resistant types with the above model numbers.

*2 1 m type lead wire is only applicable to D-A93.

* Lead wire length symbols: 0.5 m..... NII (Example) M9NW
 1 m..... M (Example) M9NWM
 3 m..... L (Example) M9NL
 5 m..... Z (Example) M9NZ

* Solid state auto switches marked with "○" are produced upon receipt of order.
 ** Available only for ø25.

It is mounted away from the port side to avoid interference with fittings.

* Since there are other applicable auto switches than listed, refer to page 749 for details.

* For details about auto switches with pre-wired connector, refer to pages 1648 and 1649.

* Auto switches are shipped together (not assembled).

Note) There is the case D-A9□V/M9□V/M9□WV/M9□AV type auto switches cannot be mounted on the port surface, depending on the cylinder's stroke and the fitting size for piping. Consult with SMC for details.

CQS Series



Symbol

Without cushion

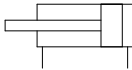

Rubber bumper

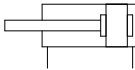

Made to Order: Individual Specifications

(For details, refer to pages 750 to 752)

Symbol	Specifications
-X271	Fluororubber seals
-X525	Long stroke of adjustable extension stroke cylinder (-XC8)
-X526	Long stroke of adjustable retraction stroke cylinder (-XC9)
-X636	Long stroke of dual stroke single rod
-X1876	With concave shape end boss on the cylinder tube head side

Made to Order Specifications

[Click here for details](#)

Symbol	Specifications
-XA□	Change of rod end shape
-XB6	Heat-resistant cylinder (-10 to 150 °C) (without an auto switch)
-XB7	Cold-resistant cylinder (-40 to 70 °C) (without an auto switch)
-XB9	Low speed cylinder (10 to 50 mm/s)
-XB10	Intermediate stroke (Using exclusive body)
-XB13	Low speed cylinder (5 to 50 mm/s)
-XC6	Piston rod, retaining ring, rod end nut made of stainless steel
-XC8	Adjustable stroke cylinder/Adjustable extension type
-XC9	Adjustable stroke cylinder/Adjustable retraction type
-XC10	Dual stroke cylinder/Double rod type
-XC11	Dual stroke cylinder/Single rod type
-XC36	With boss in rod side
-XC85	Grease for food processing equipment
-XC92	Dust resistant cylinder

Body Option

Description	Application
Rod end male thread	Available for all standard models of double acting, single rod.
Rubber bumper	

* Rubber bumper is standard equipment for long stroke type.

Moisture Control Tube IDK Series



When operating an actuator with a small diameter and a short stroke at a high frequency, the dew condensation (water droplet) may occur inside the piping depending on the conditions.

Simply connecting the moisture control tube to the actuator will prevent dew condensation from occurring. For details, refer to [the IDK series in the Best Pneumatics No. 6](#).

Specifications

Bore size (mm)	12	16	20	25	
Action	Double acting, Single rod				
Fluid	Air				
Lubrication	Not required (Non-lube)				
Proof pressure	1.5 MPa				
Maximum operating pressure	1.0 MPa				
Minimum operating pressure	0.07 MPa		0.05 MPa		
Ambient and fluid temperature	Without auto switch: -10 to 70°C (No freezing)				
	With auto switch: -10 to 60°C (No freezing)				
Cushion	None, Rubber bumper*				
Rod end thread	Female thread				
Stroke length tolerance	Standard stroke: $^{+1.0}_0$ Long stroke: $^{+1.4*}_0$				
Piston speed	50 to 500 mm/s				
Allowable kinetic energy (J)	Standard type	0.022	0.038	0.055	0.09
	With rubber bumper	0.043	0.075	0.11	0.18

* Stroke length tolerance does not include the deflection of the bumper.

* Only rubber bumper is available for the long stroke type.

Theoretical Output

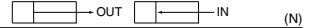

Bore size (mm)	Rod size (mm)	Operating direction	Piston area (mm ²)	Operating pressure (MPa)		
				0.3	0.5	0.7
12	6	IN	84.8	25	42	59
		OUT	113	34	57	79
16	8	IN	151	45	75	106
		OUT	201	60	101	141
20	10	IN	236	71	118	165
		OUT	314	94	157	220
25	12	IN	378	113	189	264
		OUT	491	147	245	344

Manufacture of Intermediate Stroke

Description	Spacer is installed in the standard stroke body.	Exclusive body (-XB10)			
Part no.	Refer to "How to Order" for the standard model no. (page 693).	Suffix "-XB10" to the end of standard model no. (page 693).			
Standard stroke	Description	Intermediate strokes in 1 mm increments are available by using spacers with standard stroke cylinders. Dealing with the stroke in 1 mm increments by using an exclusive body with the specified stroke.			
	Stroke range	Bore size	Stroke range	Bore size	Stroke range
		12, 16	1 to 29	12, 16	6 to 29
Long stroke	Description	Intermediate strokes in 1 mm increments are available by using spacers with standard stroke cylinders. Dealing with the stroke in 1 mm increments by using an exclusive body with the specified stroke.			
		Bore size	Stroke range	Bore size	Stroke range
	Stroke range	12, 16	31 to 199	12, 16	31 to 199
		20	51 to 199	20	51 to 199
		25	51 to 299	25	51 to 299
Example	Part no.: CQSB25-47D CQSB25-50D with 3 mm width spacer inside. B dimension is 72.5 mm.	Part no.: CQSB25-47D-XB10 Makes 47 stroke tube. B dimension is 69.5 mm.			

Refer to pages 747 to 749 for cylinders with auto switches.

- Minimum auto switch mounting stroke
- Proper auto switch mounting position (detection at stroke end) and mounting height
- Operating range
- Auto switch mounting bracket/Part no.

Weight/Without Auto Switch (g)

Bore size (mm)	Cylinder stroke (mm)																	
	5	10	15	20	25	30	35	40	45	50	75	100	125	150	175	200	250	300
12	29	36	42	49	56	63	93	100	107	113	147	180	213	246	279	312	—	—
16	38	47	56	64	73	82	119	128	136	145	187	229	271	313	355	397	—	—
20	63	75	88	101	114	127	140	153	166	178	306	370	434	498	562	627	—	—
25	91	107	123	139	155	171	186	202	218	234	399	478	557	636	715	794	952	1110

For standard stroke

Calculation: (Example) **CQSD20-20DCM**

- Cylinder weight: CQSB20-20D.....101 g
- Additional weight: Rod end male thread.....10 g
- Additional weight: Rubber bumper.....-2 g
- Additional weight: Double clevis type.....92 g

201 g

Weight/With Auto Switch (Built-in magnet) (g)

Bore size (mm)	Cylinder stroke (mm)																	
	5	10	15	20	25	30	35	40	45	50	75	100	125	150	175	200	250	300
12	37	43	50	57	63	70	94	101	108	114	148	181	214	247	280	313	—	—
16	48	57	66	74	83	92	121	129	137	146	188	231	273	315	357	399	—	—
20	93	106	119	132	144	157	170	182	195	208	311	375	439	503	567	632	—	—
25	134	150	166	182	197	213	229	245	261	277	406	485	564	643	721	800	958	1116

Additional Weight (g)

Bore size (mm)		12	16	20	25
Rod end male thread	Male thread	1.5	3	6	12
	Nut	1	2	4	8
With boss on head end		0.7	1.3	2	3
Rubber bumper * (No need to add for long stroke)		0	1	-2	-3
Compact foot type (Including mounting bolt)		41 (39)	51 (47)	121 (115)	140 (131)
Foot type (Including mounting bolt)		55 (53)	65 (61)	159 (153)	181 (172)
Rod side flange type (Including mounting bolt)		58 (56)	70 (66)	143 (137)	180 (171)
Head side flange type (Including mounting bolt)		56	66	137	171
Double clevis type (Including pin, snap ring, bolt)		34	40	92	127

() : denotes the values of long stroke model.

Mounting Bracket Part No.

Bore size (mm)	Foot (1)	Compact foot (1)	Flange	Double clevis
12	CQS-L012	CQS-LC012	CQS-F012	CQS-D012
16	CQS-L016	CQS-LC016	CQS-F016	CQS-D016
20	CQS-L020	CQS-LC020	CQS-F020	CQS-D020
25	CQS-L025	CQS-LC025	CQS-F025	CQS-D025

Note1) When ordering foot and compact foot brackets, order 2 pieces per cylinder.

Note2) Parts belonging to each bracket are as follows.

- Foot, Compact foot, Flange type: Body mounting bolt
- Double clevis type: Clevis pin, Type C retaining ring for axis, Body mounting bolt.

- CUJ**
- CU**
- CQS**
- JCQ**
- CQ2**
- RQ**
- CQM**
- CQU**
- MU**

- D-□**
- X□**
- Technical Data

Clean Series (Standard stroke is only available.)

10 — C(D)QSB Bore size — Stroke D(M)

Clean Series

10	Relief type
11	Vacuum type

The type which is applicable for using inside the clean room graded ISO Class 4 by making an actuator's rod section a double seal construction and discharging by relief port directly to the outside of clean room.

Specifications

Action	Double acting, Single rod
Bore size (mm)	ø12, ø16, ø20, ø25
Proof pressure	1.5 MPa
Maximum operating pressure	1.0 MPa
Rubber bumper	None
Piping	Screw-in piping
Piston speed	30 to 400 mm/s
Mounting	Through-hole/Both ends tapped common
Auto switch	Mountable

Note) For details, please contact SMC.

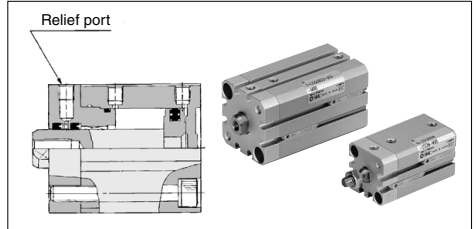

For details, refer to the "Pneumatic Clean Series" (CAT.E02-23)

Smooth Cylinder

CQS Y Mounting Bore size — Stroke DC(M)

Smooth Cylinder

Smooth operation with a little sticking and slipping at low speed.

Dual-side low friction operation is possible.



Some of the parts are different from the dimensions of the double acting, single rod type.

Refer to Best Pneumatics No. 2-3.

Low-speed Cylinder

CQS X Mounting Bore size — Stroke D(C)(M)

Low-speed Cylinder

Smooth operation with a little sticking and slipping at low speed.

Can start smoothly with a little ejection even after being rendered for hours.



The dimensions are the same as the double acting, single rod type.

Refer to Best Pneumatics No. 2-3.

Specifications

Bore size (mm)	12	16	20	25
Type	Pneumatic (Non-lube)			
Action	Double acting, Single rod			
Fluid	Air			
Proof pressure	1.05 MPa			
Maximum operating pressure	0.7 MPa			
Ambient and fluid temperature	Without auto switch: -10 to 70°C (No freezing) With auto switch: -10 to 60°C (No freezing)			
Cushion	None, Rubber bumper*			
Rod end thread	Female thread			
Stroke length tolerance	+1.0*			
Mounting	Through-hole/Both ends tapped common			
Piston speed	50 to 500 mm/s			
Allowable leakage	0.5 L/min (ANR) or less			

* Stroke length tolerance does not include the deflection of the bumper.

Minimum operating pressure (MPa)

Bore size (mm)	12	16	20	25
Minimum operating pressure	0.03		0.02	

Specifications

Bore size (mm)	12	16	20	25
Type	Pneumatic (Non-lube)			
Action	Double acting, Single rod			
Fluid	Air			
Proof pressure	1.5 MPa			
Maximum operating pressure	1.0 MPa			
Ambient and fluid temperature	Without auto switch: -10 to 70°C (No freezing) With auto switch: -10 to 60°C (No freezing)			
Rubber bumper	None, Rubber bumper*			
Rod end thread	Female thread			
Stroke length tolerance	Standard stroke $\begin{smallmatrix} +1.0 \\ 0 \end{smallmatrix}$			
Mounting	Through-hole/Both ends tapped common			
Piston speed	ø12, ø16: 1 to 300 mm/s ø20, ø25: 0.5 to 300 mm/s			

* Stroke length tolerance does not include the deflection of the bumper.

Minimum operating pressure (MPa)

	12	16	20	25
Minimum operating pressure	0.03	0.03	0.025	0.025

CUJ

CU

CQS

JCQ

CQ2

RQ

CQM

CQU

MU

D-□

-X□

Technical Data

CQS Series

Compact Cylinder with Stable Lubrication Function (Lube-retainer)

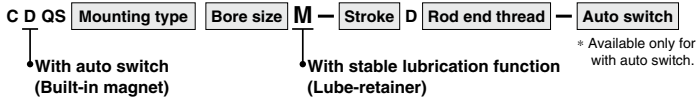

Specifications

Bore size (mm)	20, 25
Action	Double acting, Single rod
Minimum operating pressure	0.1 MPa
Piston speed	50 to 500 mm/s
Cushion	None

* Specifications other than those shown above are the same as the standard model.

Dimensions (Dimensions other than those shown below are the same as the standard model.)

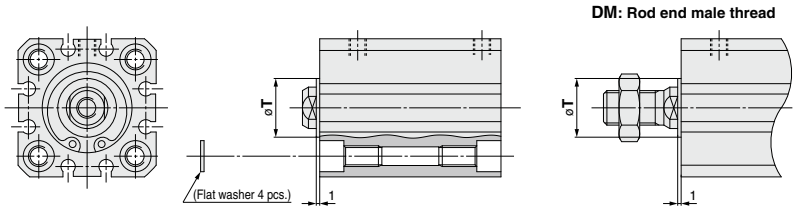

Bore size	Standard stroke	T (mm)
20	5, 10, 15, 20, 25, 30,	15
25	35, 40, 45, 50	18

* The mounting dimensions of the mounting bracket are the same as the standard model.

Mounting Bracket Part No.

Bore size (mm)	Foot	Compact foot	Flange
20	CQS-LM020	CQS-LCM020	CQS-FM020
25	CQS-LM025	CQS-LCM025	CQS-FM025

* The double clevis type is the same as the standard model.

* When ordering foot and compact foot brackets, order 2 pieces per cylinder.

For details, refer to the **Web Catalog**.

Construction

Basic type

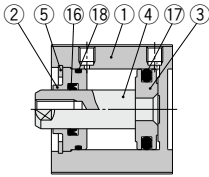

With rubber bumper

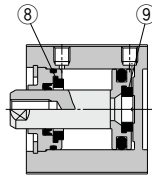

With auto switch (Built-in magnet)

ø12, ø16

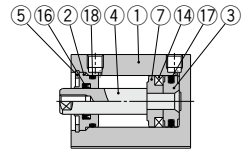

Rod end male thread

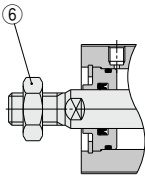

Long stroke

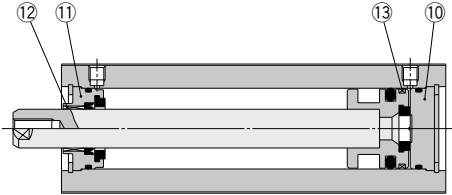

ø20, ø25

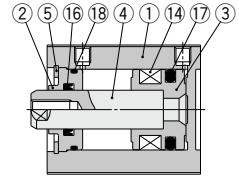

With boss on head end

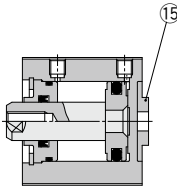

Component Parts

No.	Description	Material	Note
1	Cylinder tube	Aluminum alloy	Hard anodized
2	Collar	Aluminum alloy	Anodized
3	Piston	Aluminum alloy	
4	Piston rod	Stainless steel	
5	Retaining ring	Carbon tool steel	Phosphate coated
6	Rod end nut	Carbon steel	Zinc chromated
7	Spacer for switch type	Aluminum alloy	Chromated
8	Bumper A	Urethane	
9	Bumper B	Urethane	
10	Bottom plate	Aluminum alloy	Anodized

Component Parts

No.	Description	Material	Note
11	Collar	Aluminum alloy	Anodized
12	Bushing	Oil-impregnated sintered alloy	
13	Wear ring	Resin	
14	Magnet	—	
15	Centering location ring	Aluminum alloy	Anodized
16*	Rod seal	NBR	
17*	Piston seal	NBR	
18*	Tube gasket	NBR	

Replacement Parts: Seal Kit (Basic type)

Bore size (mm)	Kit no.	Contents
12	CQSB12-PS	Set of nos. above 16, 17, 18
16	CQSB16-PS	
20	CQSB20-PS	
25	CQSB25-PS	

Replacement Parts: Seal Kit (Long stroke)

Bore size (mm)	Kit no.	Contents
12	CQSB12-L-PS	Set of nos. above 16, 17, 18
16	CQSB16-L-PS	
20	CQSB20-L-PS	
25	CQSB25-L-PS	

* Seal kit includes 16, 17, 18. Order the seal kit, based on each bore size. (The long stroke type includes 2 tube gaskets.)

* Since the seal kit does not include a grease pack, order it separately.

Grease pack part no.: GR-S-010 (10 g)

CUJ

CU

CQS

JCQ

CQ2

RQ

CQM

CQU

MU

D-□

-X□

Technical Data

Mounting Bolt for CQS without Auto Switch

Mounting method: Mounting bolt for through-hole mounting type of CQSB is available as an option.

Refer to the following for ordering procedures.
Order the actual number of bolts that will be used.

Example) CQ-M3x25L 4 pcs.

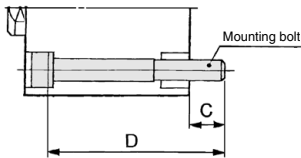

Note 1) The appropriate plain washer must be used for through-hole mounting.

Note 2) Please contact SMC for details concerning the mounting bolts to be used with $\phi 12$ and $\phi 16$ that exceed 30 mm strokes, or $\phi 20$ and $\phi 25$ that exceed 50 mm strokes.

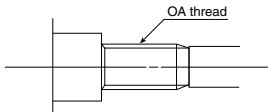

Cylinder model	C	D	Mounting bolt part no.	
CQSB12-5D	6.5	25	CQ-M3 x 25L	
-10D		30	x 30L	
-15D		35	x 35L	
-20D		40	x 40L	
-25D		45	x 45L	
-30D		50	x 50L	
-35DC				
-40DC				
-45DC				
-50DC				
-75DC				
-100DC				
-125DC				
-150DC				
-175DC				
-200DC				
CQSB16-5D	6.5	25	CQ-M3 x 25L	
-10D		30	x 30L	
-15D		35	x 35L	
-20D		40	x 40L	
-25D		45	x 45L	
-30D		50	x 50L	
-35DC				
-40DC				
-45DC				
-50DC				
-75DC				
-100DC				
-125DC				
-150DC				
-175DC				
-200DC				

Secure the cylinder by using the OA screws that are provided with the cylinder tube.

Secure the cylinder by using the OA screws that are provided with the cylinder tube.

Cylinder model	C	D	Mounting bolt part no.	
CQSB20-5D	6.5	25	CQ-M5 x 25L	
-10D		30	x 30L	
-15D		35	x 35L	
-20D		40	x 40L	
-25D		45	x 45L	
-30D		50	x 50L	
-35DC				
-40DC				
-45DC				
-50DC				
-75DC				
-100DC				
-125DC				
-150DC				
-175DC				
-200DC				
CQSB25-5D	8.5	30	CQ-M5 x 30L	
-10D		35	x 35L	
-15D		40	x 40L	
-20D		45	x 45L	
-25D		50	x 50L	
-30D		55	x 55L	
-35DC				
-40DC				
-45DC				
-50DC				
-75DC				
-100DC				
-125DC				
-150DC				
-175DC				
-200DC				
-250DC				
-300DC				

Secure the cylinder by using the OA screws that are provided with the cylinder tube.

Secure the cylinder by using the OA screws that are provided with the cylinder tube.

Material: Chromium molybdenum steel
Surface treatment: Nickel plated

Mounting Bolt for CDQS with Auto Switch

Mounting method: Mounting bolt for through-hole mounting type of CDQSB is available as an option.

Refer to the following for ordering procedures.
Order the actual number of bolts that will be used.

Example) CQ-M3x30L 4 pcs.

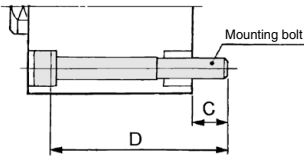

Note 1) The appropriate plain washer must be used for through-hole mounting.

Note 2) Please contact SMC for details concerning the mounting bolts to be used with $\phi 12$ and $\phi 16$ that exceed 30 mm strokes, or $\phi 20$ and $\phi 25$ that exceed 50 mm strokes.

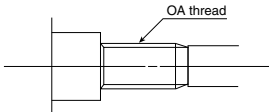

Accessory

For accessory bracket for the **CQS series**, refer to page 796, since it is commonly used with the **CQ2 series**.

- Single knuckle joint
- Pin for knuckle
- Double knuckle joint
- Rod end nut

Cylinder model	C	D	Mounting bolt part no.
CDQSB12-5D		30	CQ-M3 x 30L
-10D	6.5	35	x 35L
-15D		40	x 40L
-20D		45	x 45L
-25D		50	x 50L
-30D		55	x 55L
-35DC			
-40DC			
-45DC			
-50DC			
-75DC			
-100DC			
-125DC			
-150DC			
-175DC			
-200DC			
CDQSB16-5D		30	CQ-M3 x 30L
-10D	6.5	35	x 35L
-15D		40	x 40L
-20D		45	x 45L
-25D		50	x 50L
-30D		55	x 55L
-35DC			
-40DC			
-45DC			
-50DC			
-75DC			
-100DC			
-125DC			
-150DC			
-175DC			
-200DC			

Secure the cylinder by using the OA screws that are provided with the cylinder tube.

Secure the cylinder by using the OA screws that are provided with the cylinder tube.

Cylinder model	C	D	Mounting bolt part no.
CDQSB20-5D		35	CQ-M5 x 35L
-10D	6.5	40	x 40L
-15D		45	x 45L
-20D		50	x 50L
-25D		55	x 55L
-30D		60	x 60L
-35D		65	x 65L
-40D		70	x 70L
-45D		75	x 75L
-50D		80	x 80L
-75DC			
-100DC			
-125DC			
-150DC			
-175DC			
-200DC			
CDQSB25-5D		40	CQ-M5 x 40L
-10D	8.5	45	x 45L
-15D		50	x 50L
-20D		55	x 55L
-25D		60	x 60L
-30D		65	x 65L
-35D		70	x 70L
-40D		75	x 75L
-45D		80	x 80L
-50D		85	x 85L
-75DC			
-100DC			
-125DC			
-150DC			
-175DC			
-200DC			
-250DC			
-300DC			

Secure the cylinder by using the OA screws that are provided with the cylinder tube.

Secure the cylinder by using the OA screws that are provided with the cylinder tube.

Material: Chromium molybdenum steel
Surface treatment: Zinc chromated

CUJ

CU

CQS

JCQ

CQ2

RQ

CQM

CQU

MU

D-□

-X□

Technical Data

CQS Series

Dimensions: $\phi 12$ to $\phi 25$

Basic type (Through-hole/Both ends tapped common): CQSB/CDQSB

* For the auto switch mounting position and its mounting height, refer to page 747.

$\phi 12$



$\phi 16$

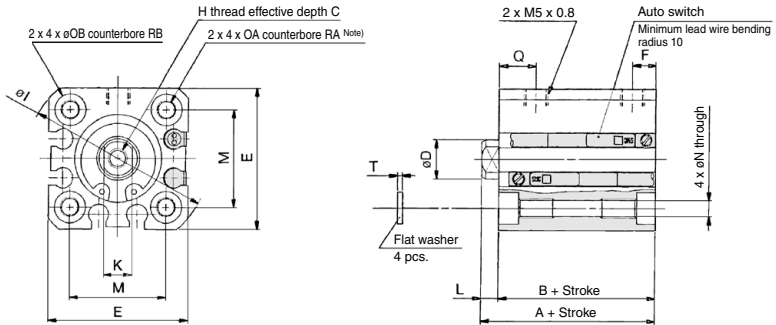

$\phi 20, \phi 25$

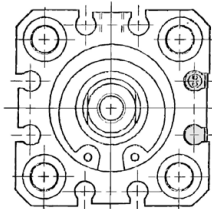

Rod end male thread

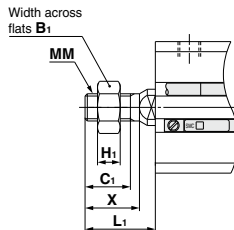

With boss on head end

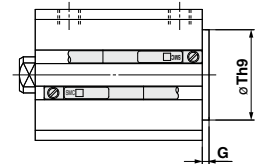

• Length with intermediate stroke

(1) Spacer ... The dimensions will be identical to those of the nearest long stroke. Those that exceed the standard stroke will have the long stroke dimensions.

(2) Exclusive body (-XB10)....Add stroke. Also, the stroke length that exceeds the standard stroke would be the long stroke dimension.

Rod End Male Thread

Bore size (mm)	B1	C1	H1	Standard stroke		Long stroke	MM	X
				L1	L1			
12	8	9	4	14	24	M5 x 0.8	10.5	
16	10	10	5	15.5	25.5	M6 x 1.0	12	
20	13	12	5	18.5	28.5	M8 x 1.25	14	
25	17	15	6	22.5	32.5	M10 x 1.25	17.5	

With Boss on Head End (mm)

Bore size (mm)	G	Th9
16	1.5	20 ⁰ _{-0.052}
20	2	13 ⁰ _{-0.043}
25	2	15 ⁰ _{-0.043}

Note1) The product with boss on head end is applicable to only the standard stroke.

Note2) With boss on rod end : Option (Suffix "-XC36" to the end of part number.)

Note that only bore sizes $\phi 12$ and $\phi 16$ are applicable to the long stroke.

Basic Type

Bore size (mm)	Standard stroke range (mm)	Standard stroke								Long stroke range (mm)	Long stroke								C	D	E	H	I	K	M	N	OA	OB	Q	RA	RB	T
		Without auto switch				With auto switch					With/Without auto switch																					
		A	B	F	L	A	B	F	L		A	B	F	L	A	B	F	L														
12	5 to 30	20.5	17	5	3.5	25.5	22	5	3.5	35 to 200	45.5	32	7.5	13.5	6	6	25	M3 x 0.5	32	5	15.5	3.5	M4 x 0.7	6.5	7.5	7	4	0.5				
16	5 to 30	20.5	17	5	3.5	25.5	22	5	3.5	35 to 200	45.5	32	7.5	13.5	8	8	29	M4 x 0.7	38	6	20	3.5	M4 x 0.7	6.5	7.5	7	4	0.5				
20	5 to 50	24	19.5	5.5	4.5	34	29.5	5.5	4.5	75 to 200	55.5	41	8	14.5	7	10	36	M5 x 0.8	47	8	25.5	5.4	M6 x 1.0	9	8	10	7	1				
25	5 to 50	27.5	22.5	5.5	5	37.5	32.5	5.5	5	75 to 300	59	44	9	15	12	12	40	M6 x 1.0	52	10	28	5.4	M6 x 1.0	9	9	10	7	1				

Note 1) For the following bore/stroke sizes through-hole is threaded over the entire length: Basic type $\phi 12$ and $\phi 16$; 5 stroke, $\phi 20$; 5 to 15 stroke, $\phi 25$; 5 to 10 stroke, $\phi 20$ with auto switch built-in magnet; 5 stroke.

Note 2) Rubber bumper type has the same dimensions as those indicated above.

* For details about the rod end nut and accessory brackets, refer to page 796.

Foot type: CQSL/CDQSL

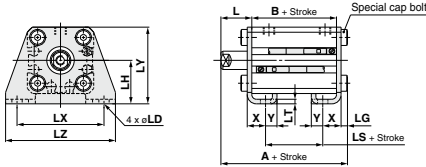

Rod end male thread

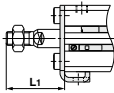

Compact foot type: CQSLC/CDQSLC

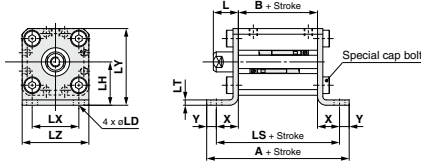

Rod end male thread

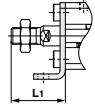

Rod side flange type: CQSF/CDQSF

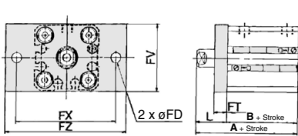

Rod end male thread

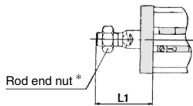

Head side flange type: CQSG/CDQSG

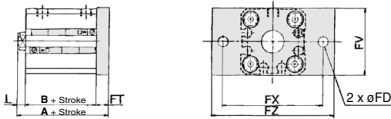

Rod end male thread

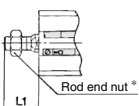

Foot Type

Bore size (mm)	Standard stroke range (mm)	Standard stroke						Long stroke range (mm)		Long stroke		
		Without auto switch			With auto switch					Without/With auto switch		
		A	B	LS	A	B	LS			A	B	LS
12	5 to 30	35.3	17	5	40.3	22	10	35 to 200		50.3	32	20
16	5 to 30	35.3	17	5	40.3	22	10	35 to 200		50.3	32	20
20	5 to 50	41.2	19.5	7.5	51.2	29.5	17.5	75 to 200		62.7	41	29
25	5 to 50	44.7	22.5	7.5	54.7	32.5	17.5	75 to 300		66.2	44	29

Bore size (mm)	L	L1	LD	LG	LH	LT	LX	LY	LZ	X	Y
12	13.5	24	4.5	2.8	17	2	34	29.5	44	8	4.5
16	13.5	25.5	4.5	2.8	19	2	38	33.5	48	8	5
20	14.5	28.5	6.6	4	24	3.2	48	42	62	9.2	5.8
25	15	32.5	6.6	4	26	3.2	52	46	66	10.7	5.8

Foot bracket material: Carbon steel
Surface treatment: Nickel plated

Compact Foot Type

Bore size (mm)	Standard stroke range (mm)	Standard stroke						Long stroke range (mm)		Long stroke		
		Without auto switch			With auto switch					Without/With auto switch		
		A	B	LS	A	B	LS			A	B	LS
12	5 to 30	44.6	17	35.6	49.6	22	40.6	35 to 200		59.6	32	50.6
16	5 to 30	45.6	17	35.6	50.6	22	40.6	35 to 200		60.6	32	50.6
20	5 to 50	57.5	19.5	45.9	67.5	29.5	55.9	75 to 200		79	41	67.4
25	5 to 50	60.5	22.5	48.9	70.5	32.5	58.9	75 to 300		82	44	70.4

Bore size (mm)	L	L1	LD	LH	LT	LX	LY	LZ	X	Y
12	13.5	24	4.5	17	2	15.5	29.5	25	9.3	4.5
16	13.5	25.5	4.5	19	2	20	33.5	29	9.3	5
20	14.5	28.5	6.6	24	3.2	25.5	42	36	13.2	5.8
25	15	32.5	6.6	26	3.2	28	46	40	13.2	5.8

Compact foot bracket material: Carbon steel
Surface treatment: Zinc chromated

Rod Side Flange Type

Bore size (mm)	Standard stroke range (mm)	Standard stroke						Long stroke range (mm)		Long stroke	
		Without auto switch			With auto switch					Without/With auto switch	
		A	B	A	B			A	B		
12	5 to 30	30.5	17	35.5	22	35 to 200		45.5	32		
16	5 to 30	30.5	17	35.5	22	35 to 200		45.5	32		
20	5 to 50	34	19.5	44	29.5	75 to 200		55.5	41		
25	5 to 50	37.5	22.5	47.5	32.5	75 to 300		59	44		

Bore size (mm)	FD	FT	FV	FX	FZ	L	L1
12	4.5	5.5	25	45	55	13.5	24
16	4.5	5.5	30	45	55	13.5	25.5
20	6.6	8	39	48	60	14.5	28.5
25	6.6	8	42	52	64	15	32.5

Flange bracket material: Carbon steel
Surface treatment: Nickel plated

Head Side Flange Type

Bore size (mm)	Standard stroke range (mm)	Standard stroke						Long stroke range (mm)		Long stroke				
		Without auto switch			With auto switch					Without/With auto switch				
		A	B	L1	A	B	L1			A	B	L1		
12	5 to 30	26	17	3.5	14	31	22	3.5	14	35 to 200	51	32	13.5	24
16	5 to 30	26	17	3.5	15.5	31	22	3.5	15.5	35 to 200	51	32	13.5	25.5
20	5 to 50	32	19.5	4.5	18.5	42	29.5	4.5	18.5	75 to 200	63.5	41	14.5	28.5
25	5 to 50	35.5	22.5	5	22.5	45.5	32.5	5	22.5	75 to 300	67	44	15	32.5

Bore size (mm)	FD	FT	FV	FX	FZ
12	4.5	5.5	25	45	55
16	4.5	5.5	30	45	55
20	6.6	8	39	48	60
25	6.6	8	42	52	64

Flange bracket material: Carbon steel
Surface treatment: Nickel plated

* For details about the rod end nut and accessory brackets, refer to page 796.

CQS Series

Dimensions: $\varnothing 12$ to $\varnothing 25$

Double clevis type: CQSD/CDQSD

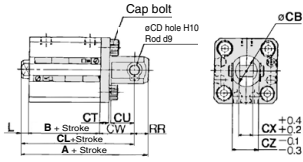

Rod end male thread

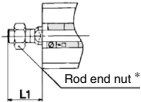

Double Clevis Type

Bore size (mm)	Standard stroke range (mm)	Standard stroke										Long stroke range (mm)	Long stroke				
		Without auto switch					With auto switch						Without		With auto switch		
		A	B	CL	L	L ₁	A	B	CL	L	L ₁		A	B	CL	L	L ₁
12	5 to 30	40.5	17	34.5	3.5	14	45.5	22	39.5	3.5	14	35 to 200	66.5	32	59.5	13.5	24
16	5 to 30	41.5	17	35.5	3.5	15.5	46.5	22	40.5	3.5	15.5	35 to 200	66.5	32	60.5	13.5	25.5
20	5 to 50	51	19.5	42	4.5	18.5	61	29.5	52	4.5	18.5	75 to 200	82.5	41	73.5	14.5	28.5
25	5 to 50	57.5	22.5	47.5	5	22.5	67.5	32.5	57.5	5	22.5	75 to 300	89	44	79	15	32.5

Bore size (mm)	CB	CD	CT	CU	CW	CX	CZ	RR
12	12	5	4	7	14	5	10	6
16	14	5	4	10	15	6.5	12	6
20	20	8	5	12	18	8	16	9
25	24	10	5	14	20	10	20	10

Double clevis bracket material: Carbon steel
Surface treatment: Nickel plated

* For details about the double clevis pivot bracket, refer to page 705.

* For details about the rod end nut and accessory brackets, refer to page 796.

CQS Series Accessory Dimensions

Double Clevis Pivot Bracket

Bore size $\varnothing 12$ to $\varnothing 25$

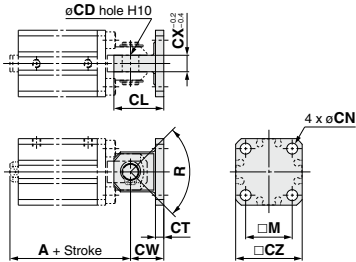

(mm)

Bracket part no.	Bore size	Stroke range	A		CW	CT	CL	CX	CD	M	CZ	R	CN	Hexagon socket head cap screw for mounting pivot bracket (Accessory)
			Without auto switch	With auto switch										
CQ-C012	12	5 to 30	34.5	39.5	14	4	19	5	5	15.5	25	100°	4.5	M4 x 10L
CQ-C016	16	5 to 30	35.5	40.5	15	4	21	6.5	5	20	28	100°	4.5	M4 x 10L
CQ-C020	20	5 to 50	42	52	18	5	27	8	8	25.5	35	80°	6.6	M6 x 12L
CQ-C025	25	5 to 50	47.5	57.5	20	5	30	10	10	28	40	90°	6.6	M6 x 12L

* The double clevis pin and retaining ring are not included.

Double clevis pivot bracket material: Carbon steel
Surface treatment: Nickel plated

CJ

CU

CQS

JCQ

CQ2

RQ

CQM

CQU

MU

D-□

-X□

Technical
Data

Compact Cylinder: Standard Type Double Acting, Double Rod

CQSW Series

∅12, ∅16, ∅20, ∅25

How to Order

With auto switch CQSW **B** 20-30 **D** **C** - []

With auto switch CDQSW **B** 20-30 **D** **C** - **M9BW** [] - []

With auto switch (Built-in magnet)

Mounting type

B	Through-hole/Both ends tapped common (Standard)
L	Foot type
LC	Compact foot type
F	Flange type

* Mounting brackets are shipped together (but not assembled).
* Cylinder mounting bolts are not included. Order them separately referring to "Mounting Bolt for CQSW" on page 710.

Bore size

12	12 mm
16	16 mm
20	20 mm
25	25 mm

Cylinder stroke (mm)

Bore size (mm)	Standard stroke (mm)
12, 16	5, 10, 15, 20, 25, 30
20, 25	5, 10, 15, 20, 25, 30, 35, 40, 45, 50

Standard Stroke

Number of auto switches

Nil	2 pcs.
S	1 pc.
n	"n" pcs.

Auto switch

Nil	Without auto switch
------------	---------------------

* Refer to the table below for the applicable auto switch model.

Body option

Nil	Standard
C	With rubber bumper
M	Rod end male thread

* Combination of body options is available. CM

Action

D	Double acting
----------	---------------

Built-in Magnet Cylinder Model

If a built-in magnet cylinder without an auto switch is required, there is no need to enter the symbol for the auto switch.
(Example) CDQSWL25-30D

Applicable Auto Switches/Refer to pages 1575 to 1701 for further information on auto switches.

Type	Special function	Electrical entry	Indicator light	Wiring (Output)	Load voltage		Auto switch model		Lead wire length (m)			Pre-wired connector	Applicable load			
					DC	AC	Perpendicular	In-line	0.5 (Nil)	1 (M)	3 (L)		5 (Z)			
Solid state auto switch	—	Grommet	Yes	3-wire (NPN)	5 V, 12 V	—	M9NV	M9N	●	●	●	○	IC circuit	Relay, PLC		
				3-wire (PNP)			M9PV	M9P	●	●	●	○				
				2-wire	M9BV		M9B	●	●	●	○	—				
				3-wire (NPN)	M9NWV		M9NV	●	●	●	○	IC circuit				
	3-wire (PNP)			M9PWV	M9PW		●	●	●	○	—					
	2-wire			M9BWW	M9BW		●	●	●	○	—					
	3-wire (NPN)			M9NAV ^{*1}	M9NA ^{*1}		○	○	○	○	—					
	3-wire (PNP)			M9PAV ^{*1}	M9PA ^{*1}		○	○	○	○	IC circuit					
Water resistant (2-color indicator)	—	Grommet	Yes	2-wire	5 V, 12 V	M9BAV ^{*1}	M9BA ^{*1}	○	○	○	○	—	—			
				2-wire (Non-polar)	—	—	P3DWA ^{**}	●	●	●	○	—				
				3-wire (NPN equivalent)	—	5 V	A96V	A96	●	—	●	—	—	IC circuit	—	
				2-wire	24 V	12 V	100 V	A93V ^{*2}	A93	●	●	●	—	—	Relay, PLC	
Reed auto switch	—	Grommet	No	2-wire	24 V	12 V	100 V or less	A90V	A90	●	—	●	—	—	IC circuit	—

*1 Water resistant type auto switches can be mounted on the above models, but in such case SMC cannot guarantee water resistance.

Consult with SMC regarding water resistant types with the above model numbers.

*2 1 m type lead wire is only applicable to D-A93.

* Lead wire length symbols: 0.5 m..... Nil (Example) M9NV
1 m..... M (Example) M9NWV
3 m..... L (Example) M9NWL
5 m..... Z (Example) M9NZ

* Solid state auto switches marked with "○" are produced upon receipt of order.

** Available only for ∅25.

It is mounted away from the port side to avoid interference with fittings.

* Since there are other applicable auto switches than listed, refer to page 749 for details.

* For details about auto switches with pre-wired connector, refer to pages 1648 and 1649.

* Auto switches are shipped together (not assembled).

Note) There is the case D-A9□V/M9□V/M9□V/M9□V/M9□AV type auto switches cannot be mounted on the port surface, depending on the cylinder's stroke and the fitting size for piping. Consult with SMC for details.

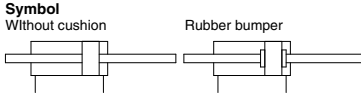

Specifications

Bore size (mm)		12	16	20	25
Action	Double acting, Double rod				
Fluid	Air				
Lubrication	Not required (Non-lube)				
Proof pressure	1.5 MPa				
Maximum operating pressure	1.0 MPa				
Minimum operating pressure	0.07 MPa		0.05 MPa		
Ambient and fluid temperature	Without auto switch: -10 to 70°C (No freezing)				
	With auto switch: -10 to 60°C (No freezing)				
Cushion	None, Rubber bumper				
Rod end thread	Female thread				
Stroke length tolerance	+1.0 mm * 0				
Piston speed	50 to 500 mm/s				
Allowable kinetic energy (J)	Standard type	0.022	0.038	0.055	0.09
	With rubber bumper	0.043	0.075	0.11	0.18

* Stroke length tolerance does not include the deflection of the bumper.

Made to Order
Made to Order: Individual Specifications
(For details, refer to pages 750 and 751.)

Symbol	Specifications
-X235	Change of piston rod end of double rod cylinder
-X271	Fluororubber seals
-X633	Intermediate stroke of double rod cylinder

Made to Order Specifications

[Click here for details](#)

Symbol	Specifications
-XA□	Change of rod end shape
-XB6	Heat-resistant cylinder (-10 to 150 °C) (without an auto switch)
-XB7	Cold-resistant cylinder (-40 to 70 °C) (without an auto switch)
-XB9	Low speed cylinder (10 to 50 mm/s)
-XB10	Intermediate stroke (Using exclusive body)
-XB13	Low speed cylinder (5 to 50 mm/s)
-XC6	Piston rod, retaining ring, rod end nut made of stainless steel
-XC36	With boss in rod side
-XC85	Grease for food processing equipment

Body Option

Description	Application
Rod end male thread	Available for all standard models of double acting, double rod.
Rubber bumper	

Mounting Bracket Part No.

Bore size (mm)	Foot (1)	Compact foot (1)	Flange
12	CQS-L012	CQS-LC012	CQS-F012
16	CQS-L016	CQS-LC016	CQS-F016
20	CQS-L020	CQS-LC020	CQS-F020
25	CQS-L025	CQS-LC025	CQS-F025

Note 1) When ordering foot and compact foot brackets, order 2 pieces per cylinder.

Note 2) Parts belonging to each bracket are as follows.
Foot, Compact foot, Flange type: Body mounting bolt

Moisture Control Tube IDK Series



When operating an actuator with a small diameter and a short stroke at a high frequency, the dew condensation (water droplet) may occur inside the piping depending on the conditions.

Simply connecting the moisture control tube to the actuator will prevent dew condensation from occurring. For details, refer to [the IDK series in the Best Pneumatics No. 6.](#)

Theoretical Output

(N)

Bore size (mm)	Rod size (mm)	Operating direction	Piston area (mm ²)	Operating pressure (MPa)		
				0.3	0.5	0.7
12	6	IN	84.8	25	42	59
		OUT				
16	8	IN	151	45	75	106
		OUT				
20	10	IN	236	71	118	165
		OUT				
25	12	IN	378	113	189	264
		OUT				

Manufacture of Intermediate Stroke

Description	Spacer is installed in the standard stroke body.	Exclusive body (-XB10)
Part no.	Suffix "-X633" to the end of standard model no. (page 706).	Suffix "-XB10" to the end of standard model no. (page 706).
Description	Intermediate strokes in 1 mm increments are available by using spacers with standard stroke cylinders.	Dealing with the stroke in 1 mm increments by using an exclusive body with the specified stroke.
Stroke range	Bore size	Bore size
	Stroke range	Stroke range
Example	Part no.: CQSWB25-47D-X633	Part no.: CQSWB25-47D-XB10
	CQSWB25-50D with 3 mm width spacer inside.	Makes 47 stroke tube.
	B dimension is 79 mm.	B dimension is 76 mm.

Refer to pages 747 to 749 for cylinders with auto switches.

- Minimum auto switch mounting stroke
- Proper auto switch mounting position (detection at stroke end) and mounting height
- Operating range
- Auto switch mounting bracket/Part no.

CUJ

CU

CQS

JCQ

CQ2

RQ

CQM

CQU

MU

D-□

-X□

Technical Data

Weight/Without Auto Switch (g)

Bore size (mm)	Cylinder stroke (mm)									
	5	10	15	20	25	30	35	40	45	50
12	38	46	54	62	69	77	-	-	-	-
16	50	61	71	81	92	102	-	-	-	-
20	89	104	120	136	152	167	183	199	215	231
25	127	146	166	186	206	227	247	267	287	308

Weight/With Auto Switch (Built-in magnet) (g)

Bore size (mm)	Cylinder stroke (mm)									
	5	10	15	20	25	30	35	40	45	50
12	46	54	62	70	77	85	-	-	-	-
16	60	71	81	91	102	112	-	-	-	-
20	119	134	150	166	182	198	214	230	245	261
25	154	174	195	215	235	255	276	296	316	336

Additional Weight (g)

Bore size (mm)		12	16	20	25
Rod end male thread	Male thread	3	6	12	24
	Nut	2	4	8	16
With rubber bumper		0	-1	-2	-2
Foot type (Including mounting bolt)		55	65	159	181
Compact foot type (Including mounting bolt)		41	51	121	140
Rod side flange type (Including mounting bolt)		58	70	143	180

Calculation: (Example) CQSWF12-10DM

- Cylinder weight: CQSWB12-10D.....46 g
- Additional weight: Rod end male thread.....5 g
- : Rod side flange type.....58 g

109 g

Caution

Retaining Ring Installation/Removal

1. For installation and removal, use an appropriate pair of pliers (tool for installing a type C retaining ring).
2. Even if a proper plier (tool for installing type C retaining ring) is used, it is likely to inflict damage to a human body or peripheral equipment, as a retaining ring may be flown out of the tip of a plier (tool for installing a type C retaining ring). Be much careful with the popping of a retaining ring. Besides, be certain that a retaining ring is placed firmly into the groove of rod cover before supplying air at the time of installment.

Warning

Mounting

Do not apply the reverse torque to the piston rods sticking out from both sides of this cylinder at the same time. The torque makes connection threads inside loosen, which may cause an accident or malfunction.

Install or remove a load while the piston rod width across flats are secured. Do not fix the other side of piston rod width across flat and apply the reverse torque.

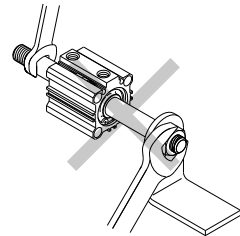
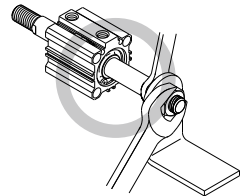

Construction

Basic type

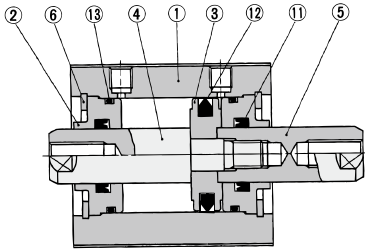

With rubber bumper

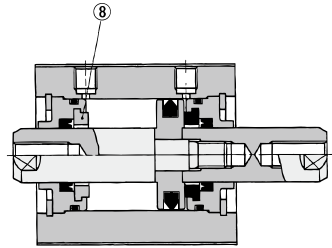

With auto switch (Built-in magnet)

ø12, ø16

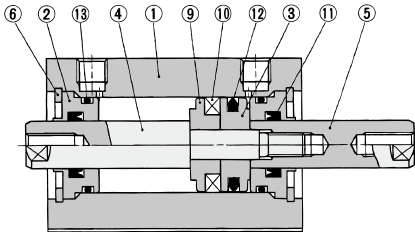

ø20, ø25

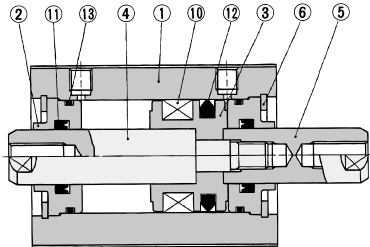

Component Parts

No.	Description	Material	Note
1	Cylinder tube	Aluminum alloy	Hard anodized
2	Collar	Aluminum alloy	Anodized
3	Piston	Aluminum alloy	
4	Piston rod A	Stainless steel	
5	Piston rod B	Stainless steel	
6	Retaining ring	Carbon tool steel	Phosphate coated
7	Rod end nut	Carbon steel	Zinc chromated
8	Bumper	Urethane	
9	Spacer for switch	Aluminum alloy	Chromated
10	Magnet	—	
11	Rod seal	NBR	
12	Piston seal	NBR	
13	Tube gasket	NBR	

Rod end male thread

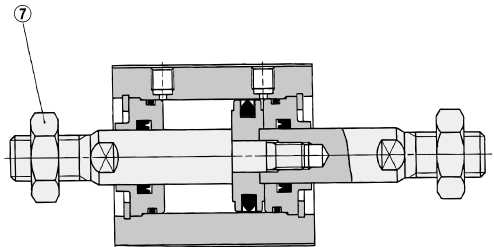

Replacement Parts/Seal Kit

Bore size (mm)	Kit no.	Contents
12	CQSWB12-PS	Set of nos. above ⑪, ⑫, ⑬
16	CQSWB16-PS	
20	CQSWB20-PS	
25	CQSWB25-PS	

* Seal kit includes ⑪, ⑫, ⑬. Order the seal kit, based on each bore size.

* Since the seal kit does not include a grease pack, order it separately.

Grease pack part no.: GR-S-010 (10 g)

CUJ

CU

CQS

JCQ

CQ2

RQ

CQM

CQU

MU

D-□

-X□

Technical
Data

CQSW Series

Mounting Bolt for CQSW

Mounting method: Mounting bolt for through-hole mounting type of CQSW is available as an option.

Refer to the following for ordering procedures. Order the actual number of bolts that will be used.

Example) CQ-M3x30L 4 pcs.

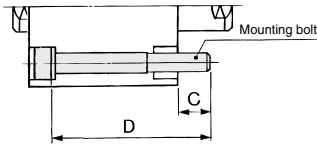

Note) When mounting a cylinder with through-hole, be sure to use the attached plain washer.

Cylinder model	C	D	Mounting bolt part no.
CQSWB12-5D		30	CQ-M3 x 30L
-10D	6.5	35	x 35L
-15D		40	x 40L
-20D		45	x 45L
-25D		50	x 50L
-30D		55	x 55L
CQSWB16-5D		30	CQ-M3 x 30L
-10D	6.5	35	x 35L
-15D		40	x 40L
-20D		45	x 45L
-25D		50	x 50L
-30D		55	x 55L
CQSWB20-5D		35	CQ-M5 x 35L
-10D	10	40	x 40L
-15D		45	x 45L
-20D		50	x 50L

Cylinder model	C	D	Mounting bolt part no.
CQSWB20-25D		55	CQ-M5 x 55L
-30D	10	60	x 60L
-35D		65	x 65L
-40D		70	x 70L
-45D		75	x 75L
-50D		80	x 80L
CQSWB25-5D		35	CQ-M5 x 35L
-10D	7	40	x 40L
-15D		45	x 45L
-20D		50	x 50L
-25D		55	x 55L
-30D		60	x 60L
-35D		65	x 65L
-40D		70	x 70L
-45D	75	x 75L	
-50D	80	x 80L	

Material: Chromium molybdenum steel
Surface treatment: Zinc chromated

Mounting Bolt for CDQSW with Auto Switch

Mounting method: Mounting bolt for through-hole mounting type of CDQSW is available as an option.

Refer to the following for ordering procedures. Order the actual number of bolts that will be used.

Example) CQ-M3x35L 4 pcs.

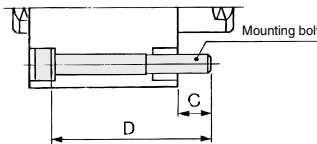

Note) When mounting a cylinder with through-hole, be sure to use the attached plain washer.

Cylinder model	C	D	Mounting bolt part no.
CDQSWB12-5D		35	CQ-M3 x 35L
-10D	6.5	40	x 40L
-15D		45	x 45L
-20D		50	x 50L
-25D		55	x 55L
-30D		60	x 60L
CDQSWB16-5D		35	CQ-M3 x 35L
-10D	6.5	40	x 40L
-15D		45	x 45L
-20D		50	x 50L
-25D		55	x 55L
-30D		60	x 60L
CDQSWB20-5D		45	CQ-M5 x 45L
-10D	10	50	x 50L
-15D		55	x 55L
-20D		60	x 60L

Cylinder model	C	D	Mounting bolt part no.
CDQSWB20-25D		65	CQ-M5 x 65L
-30D	10	70	x 70L
-35D		75	x 75L
-40D		80	x 80L
-45D		85	x 85L
-50D		90	x 90L
CDQSWB25-5D		45	CQ-M5 x 45L
-10D	7	50	x 50L
-15D		55	x 55L
-20D		60	x 60L
-25D		65	x 65L
-30D		70	x 70L
-35D		75	x 75L
-40D		80	x 80L
-45D	85	x 85L	
-50D	90	x 90L	

Material: Chromium molybdenum steel
Surface treatment: Zinc chromated

Dimensions: $\phi 12$ to $\phi 25$

Basic type (Through-hole/Both ends tapped common): CQSWB/CDQSWB

$\phi 12$

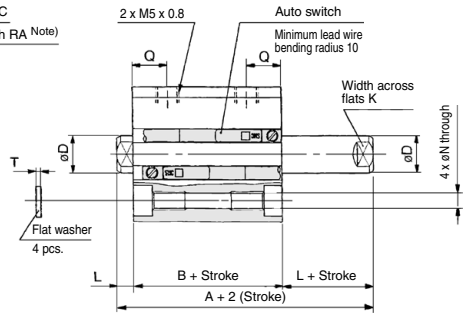
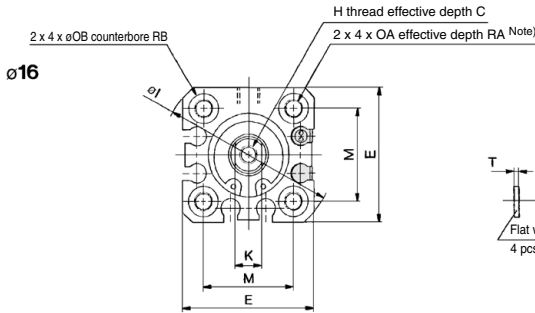
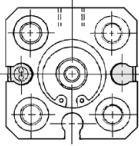

$\phi 20, \phi 25$

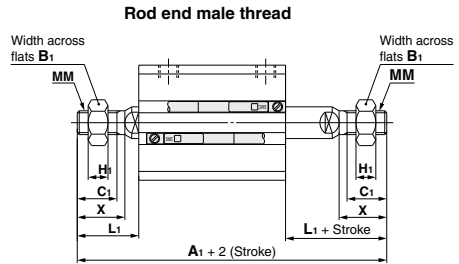
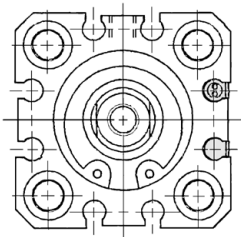

Rod End Male Thread

Bore size (mm)	Without auto switch		With auto switch		B ₁	C ₁	H ₁	L ₁	MM	X
	A ₁	B ₁	A ₁	B ₁						
12	50	55	8	9	4	14	M5 x 0.8	10.5		
16	53	58	10	10	5	15.5	M6 x 1.0	12		
20	63	73	13	12	5	18.5	M8 x 1.25	14		
25	74	84	17	15	6	22.5	M10 x 1.25	17.5		

Basic Type

Bore size (mm)	Stroke range (mm)	Without auto switch		With auto switch		C	D	E	H	I	K	L	M	N	OA	OB	Q	RA	RB	T
		A	B	A	B															
12	5 to 30	29	22	34	27	6	6	25	M3 x 0.5	32	5	3.5	15.5	3.5	M4 x 0.7	6.5	7.5	7	4	0.5
16	5 to 30	29	22	34	27	8	8	29	M4 x 0.7	38	6	3.5	20	3.5	M4 x 0.7	6.5	7.5	7	4	0.5
20	5 to 50	35	26	45	36	7	10	36	M5 x 0.8	47	8	4.5	25.5	5.4	M6 x 1.0	9	8	10	7	1
25	5 to 50	39	29	49	39	12	12	40	M6 x 1.0	52	10	5	28	5.4	M6 x 1.0	9	9	10	7	1

Note 1) For basic type $\phi 20$ and $\phi 25$ with 5 stroke, through-hole is threaded over the entire length.

Note 2) Rubber bumper type has the same dimensions as those indicated above

Note 3) The positions of width across flats on both sides are not the same.

* For details about the rod end nut and accessory brackets, refer to page 796.

- CUJ
- CU
- CQS
- JCQ
- CQ2
- RQ
- CQM
- CQU
- MU

- D-
- X
- Technical Data

CQSW Series

Dimensions: $\varnothing 12$ to $\varnothing 25$

Foot type: CQSWL/CDQSWL

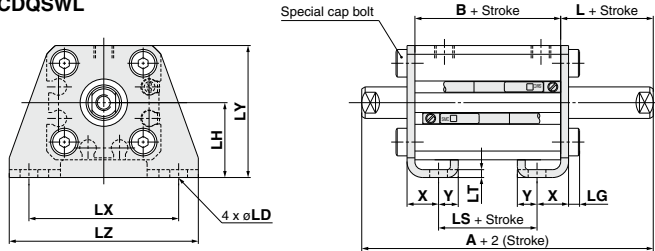

Rod end male thread

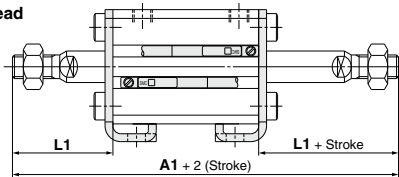

Foot Type

Bore size (mm)	Stroke range (mm)	Without auto switch				With auto switch				L	L1	LD	LG	LH	LT	LX	LY	LZ	X	Y
		A	A1	B	LS	A	A1	B	LS											
12	5 to 30	49	70	22	10	54	75	27	15	13.5	24	4.5	2.8	17	2	34	29.5	44	8	4.5
16	5 to 30	49	73	22	10	54	78	27	15	13.5	25.5	4.5	2.8	19	2	38	33.5	48	8	5
20	5 to 50	55	83	26	14	65	93	36	24	14.5	28.5	6.6	4	24	3.2	48	42	62	9.2	5.8
25	5 to 50	59	94	29	14	69	104	39	24	15	32.5	6.6	4	26	3.2	52	46	66	10.7	5.8

Foot bracket material: Carbon steel
Surface treatment: Nickel plated

Compact foot type: CQSWLC/CDQSWLC

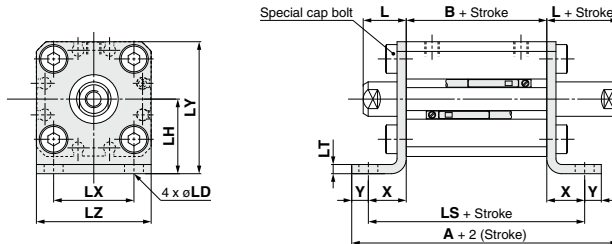

Rod end male thread

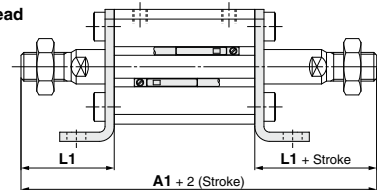

Compact Foot Type

Bore size (mm)	Stroke range (mm)	Without auto switch				With auto switch				L	L1	LD	LH	LT	LX	LY	LZ	X	Y
		A	A1	B	LS	A	A1	B	LS										
12	5 to 30	49.3	70	22	40.6	54.3	75	27	45.6	13.5	24	4.5	17	2	15.5	29.5	25	9.3	4.5
16	5 to 30	49.8	73	22	40.6	54.8	78	27	45.6	13.5	25.5	4.5	19	2	20	33.5	29	9.3	5
20	5 to 50	59.5	83	26	52.4	69.5	93	36	62.4	14.5	28.5	6.6	24	3.2	25.5	42	36	13.2	5.8
25	5 to 50	63	94	29	55.4	73	104	39	65.4	15	32.5	6.6	26	3.2	28	46	40	13.2	5.8

* For details about the rod end nut and accessory brackets, refer to page 796.

Compact foot bracket material: Carbon steel
Surface treatment: Zinc chromated

Dimensions: $\varnothing 12$ to $\varnothing 25$

Flange type: CQSWF/CDQSWF

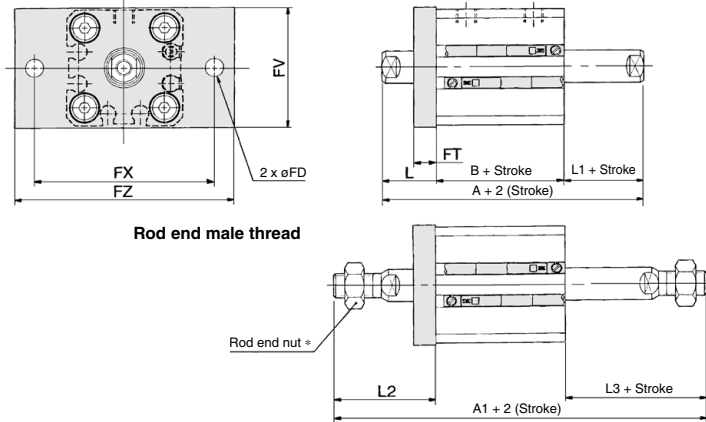

Flange Type

Bore size (mm)	Stroke range (mm)	Without auto switch			With auto switch			FD	FT	FV	FX	FZ	L	L1	L2	L3
		A	A1	B	A	A1	B									
12	5 to 30	39	60	22	44	65	27	4.5	5.5	25	45	55	13.5	3.5	24	14
16	5 to 30	39	63	22	44	68	27	4.5	5.5	30	45	55	13.5	3.5	25.5	15.5
20	5 to 50	45	73	26	55	83	36	6.6	8	39	48	60	14.5	4.5	28.5	18.5
25	5 to 50	49	84	29	59	94	39	6.6	8	42	52	64	15	5	32.5	22.5

* For details about the rod end nut and accessory brackets, refer to page 796.
 Note 1) The positions of width across flats on both sides are not the same.

Flange bracket material: Carbon steel
 Surface treatment: Nickel plated

- CUJ**
- CU**
- CQS**
- JCQ**
- CQ2**
- RQ**
- CQM**
- CQU**
- MU**

- D-□**
- X□**
- Technical Data

Compact Cylinder: Standard Type Single Acting, Single Rod

CQS Series

∅12, ∅16, ∅20, ∅25

How to Order

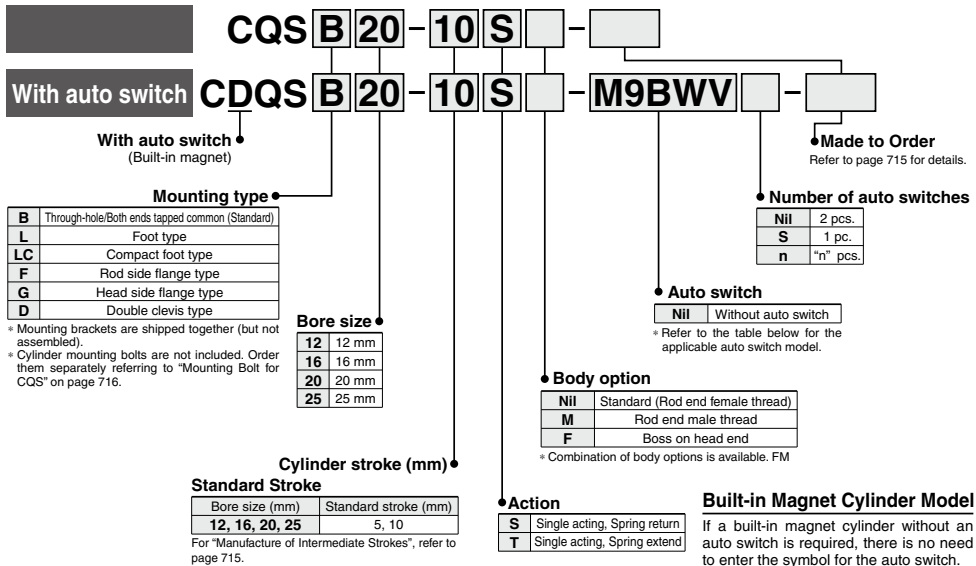

Applicable Auto Switches/Refer to pages 1575 to 1701 for further information on auto switches.

Type	Special function	Electrical entry	Indicator light	Wiring (Output)	Load voltage		Auto switch model		Lead wire length (m)			Pre-wired connector	Applicable load			
					DC	AC	Perpendicular	In-line	0.5 (Nil)	1 (M)	3 (L)			5 (Z)		
Solid state auto switch	—	Grommet	Yes	3-wire (NPN)	5 V, 12 V	—	M9NV (M9N)	●	●	●	○	○	IC circuit	Relay, PLC		
				3-wire (PNP)			M9PV (M9P)	●	●	●	○	○				
				2-wire	M9B (M9B)		●	●	●	○	○					
	Diagnostic indication (2-color indicator)			3-wire (NPN)	5 V, 12 V		M9NWW (M9NWW)	●	●	●	○	○			○	IC circuit
				3-wire (PNP)	5 V, 12 V		M9PWW (M9PWW)	●	●	●	○	○			○	IC circuit
				2-wire	12 V		M9BWW (M9BWW)	●	●	●	○	○			○	IC circuit
Water resistant (2-color indicator)	3-wire (NPN)	5 V, 12 V	M9NAV*1 (M9NA)*1	○	○	○	●	●	●	○	○	IC circuit				
	3-wire (PNP)	5 V, 12 V	M9PAV*1 (M9PA)*1	○	○	○	●	●	●	○	○	IC circuit				
	2-wire	12 V	M9BAV*1 (M9BA)*1	○	○	○	●	●	●	○	○	IC circuit				
Reed auto switch	—	Grommet	Yes	3-wire (NPN equivalent)	—	5 V	A96V	A96	●	—	—	—	—	IC circuit	—	
				2-wire			24 V	12 V	A93V*2	A93	●	●	●	●	—	—
				2-wire	24 V		100 V or less	A90V	A90	●	—	—	—	—	—	IC circuit

*1 Water resistant type auto switches can be mounted on the above models, but in such case SMC cannot guarantee water resistance.

Consult with SMC regarding water resistant types with the above model numbers.

*2 1 m type lead wire is only applicable to D-A93.

* Lead wire length symbols: 0.5 m..... Nil (Example) M9NWW
1 m..... M (Example) M9NWWM
3 m..... L (Example) M9NWWL
5 m..... Z (Example) M9NWWZ

* Solid state auto switches marked with "○" are produced upon receipt of order.

* Since there are other applicable auto switches than listed, refer to page 749 for details.

* For details about auto switches with pre-wired connector, refer to pages 1648 and 1649.

* Auto switches are shipped together (not assembled).

Note 1) There is the case D-A9□V/M9□V/M9□V/M9□V type auto switches cannot be mounted on the port surface, depending on the cylinder's stroke and the fitting size for piping. Consult with SMC for details.

Note 2) The D-M9□□□ (in-line entry) type auto switch in () cannot be mounted due to the manufacturable stroke. When this auto switch satisfies the conditions stated in Note 3) on page 749, it can be ordered separately.

Standard Specifications

Bore size (mm)	12	16	20	25
Action	Single acting, Single rod			
Fluid	Air			
Lubrication	Not required (Non-lube)			
Proof pressure	1.5 MPa			
Maximum operating pressure	1.0 MPa			
Minimum operating pressure	0.25 MPa		0.18 MPa	
Ambient and fluid temperature	Without auto switch: -10 to 70°C (No freezing)			
	With auto switch: -10 to 60°C (No freezing)			
Cushion	None			
Rod end thread	Female thread			
Stroke length tolerance	+1.0 mm 0			
Piston speed	50 to 500 mm/s			
Allowable kinetic energy (J)	0.022	0.038	0.055	0.09



Symbol

Single acting,
Spring return

Single acting,
Spring extend

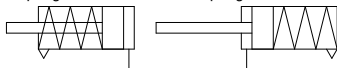

Made to Order:

Individual Specifications

(For details, refer to pages 750 and 752.)

Symbol	Specifications
-X271	Fluororubber seals
-X1876	With concave shape end boss on the cylinder tube head side

Made to Order Specifications

[Click here for details](#)

Symbol	Specifications
-XA	Change of rod end shape
-XB10	Intermediate stroke (Using exclusive body), Extension type only
-XC6	Piston rod, retaining ring, rod end nut made of stainless steel
-XC36	With boss on rod side, ø12 and ø16 only
-XC85	Grease for food processing equipment

Body Option

Description	Application
Rod end male thread	Available for all standard models of single acting, single rod.

Mounting Bracket Part No.

Bore size (mm)	Foot (1)	Compact foot (1)	Flange	Double clevis
12	CQS-L012	CQS-LC012	CQS-F012	CQS-D012
16	CQS-L016	CQS-LC016	CQS-F016	CQS-D016
20	CQS-L020	CQS-LC020	CQS-F020	CQS-D020
25	CQS-L025	CQS-LC025	CQS-F025	CQS-D025

Note 1) When ordering foot and compact foot brackets, order 2 pieces per cylinder.

Note 2) Parts belonging to each bracket are as follows.

Foot, Compact foot, Flange type: Body mounting bolt
Double clevis type: Clevis pin, Type C retaining ring for axis, Body mounting bolt.

Moisture Control Tube IDK Series



When operating an actuator with a small diameter and a short stroke at a high frequency, the dew condensation (water droplet) may occur inside the piping depending on the conditions.

Simply connecting the moisture control tube to the actuator will prevent dew condensation from occurring. For details, refer to [the IDK series in the Best Pneumatics No. 6.](#)

Theoretical Output

(N)

Action	Bore size (mm)	Rod size (mm)	Operating direction	Piston area (mm ²)	Operating pressure (MPa)			Retracted side	Extended side
					0.3	0.5	0.7		
Spring return	12	6	IN	—	20	43	65	14	4
			OUT	113	—	—	—	—	—
	16	8	IN	—	45	86	126	15	6
			OUT	201	—	—	—	—	—
	20	10	IN	—	78	141	204	15	6
			OUT	314	—	—	—	—	—
25	12	IN	—	126	224	323	21	11	
		OUT	491	—	—	—	—	—	
Spring extend	12	6	IN	84.8	14	31	48	10	3
			OUT	—	—	—	—	—	—
	16	8	IN	151	24	54	85	19	4
			OUT	—	—	—	—	—	—
	20	10	IN	236	44	91	138	27	5
			OUT	—	—	—	—	—	—
25	12	IN	378	84	160	235	29	10	
		OUT	—	—	—	—	—	—	

Manufacture of Intermediate Stroke

(Single acting, Spring retract type is excluded.)

Description	Spacer is installed in the standard stroke body.	
Part no.	Refer to "How to Order" for the standard model no. (page 714).	
Description	Intermediate strokes in 1 mm increments are available by using spacers with standard stroke cylinders.	
Stroke range	Bore size	Stroke range
	12 to 25	1 to 9
Example	Part no.: CQSB20-3T CQSB20-5T with 2 mm width spacer inside. B dimension is 24.5 mm.	

Refer to pages 747 to 749 for cylinders with auto switches.

- Minimum auto switch mounting stroke
- Proper auto switch mounting position (detection at stroke end) and mounting height
- Operating range

CUJ

CU

CQS

JCQ

CQ2

RQ

CQM

CQU

MU

D-□

-X□

Technical Data

CQS Series

Weight/Without Auto Switch Spring return (Spring extend) (g)

Bore size (mm)	Cylinder stroke (mm)	
	5	10
12	29 (31)	36 (37)
16	39 (39)	48 (47)
20	63 (68)	76 (79)
25	92 (98)	108 (113)

* (): Denotes the values of spring extend.

Weight/With Auto Switch (Built-in magnet) Spring return (Spring extend) (g)

Bore size (mm)	Cylinder stroke (mm)	
	5	10
12	37 (39)	44 (45)
16	49 (51)	58 (59)
20	94 (104)	107 (115)
25	130 (150)	146 (165)

* (): Denotes the values of spring extend.

Additional Weight (g)

Bore size (mm)					
	12	16	20	25	
Rod end male thread	Male thread	1.5	3	6	12
	Nut	1	2	4	8
Foot type (Including mounting bolt)	55	65	159	181	
Compact foot type (Including mounting bolt)	41	51	121	140	
Rod side flange type (Including mounting bolt)	58	70	143	180	
Head side flange type (Including mounting bolt)	56	66	137	171	
Double clevis type (Including pin, retaining ring, bolt)	34	40	92	127	

Calculation: (Example) CQSG16-10S

- Cylinder weight: CQSB16-10S.....48 g
 - Additional weight: Head side flange type66 g
- 114 g

Mounting Bolt for CQS without Auto Switch

Mounting method: Mounting bolt for through-hole mounting type of CQS is available as an option.

Refer to the following for ordering procedures.
Order the actual number of bolts that will be used.

Example) CQ-M3x25L 4 pcs.

Single acting, Spring return

Single acting, Spring extend

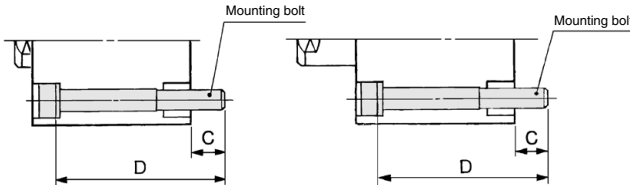

Note) When mounting a cylinder with through-hole, be sure to use the attached plain washer.

Mounting Bolt for CDQS with Auto Switch

Mounting method: Mounting bolt for through-hole mounting type of CDQS is available as an option.

Refer to the following for ordering procedures.
Order the actual number of bolts that will be used.

Example) CQ-M3x30L 4 pcs.

Single acting, Spring return

Single acting, Spring extend

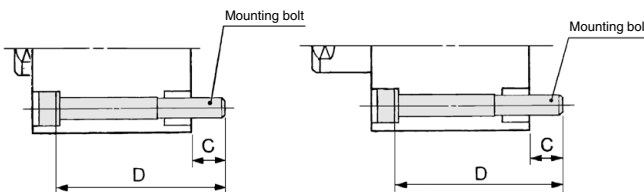

Note) When mounting a cylinder with through-hole, be sure to use the attached plain washer.

⚠ Caution

Retaining Ring Installation/Removal

1. For installation and removal, use an appropriate pair of pliers (tool for installing a type C retaining ring).
2. Even if a proper plier (tool for installing type C retaining ring) is used, it is likely to inflict damage to a human body or peripheral equipment, as a retaining ring may be flown out of the tip of a plier (tool for installing a type C retaining ring). Be much careful with the popping of a retaining ring. Besides, be certain that a retaining ring is placed firmly into the groove of rod cover before supplying air at the time of installation.

Single Acting, Spring Return

Cylinder model	C	D	Mounting bolt part no.
CQSB12-5S	6.5	25	CQ-M3 x 25L
		30	x 30L
CQSB16-5S	6.5	25	CQ-M3 x 25L
		30	x 30L
CQSB20-5S	6.5	25	CQ-M5 x 25L
		30	x 30L
CQSB25-5S	8.5	30	CQ-M5 x 30L
		35	x 35L

Single Acting, Spring Extend

Cylinder model	C	D	Mounting bolt part no.
CQSB12-5T	6.5	25	CQ-M3 x 25L
		30	x 30L
CQSB16-5T	6.5	25	CQ-M3 x 25L
		30	x 30L
CQSB20-5T	6.5	25	CQ-M5 x 25L
		30	x 30L
CQSB25-5T	8.5	30	CQ-M5 x 30L
		35	x 35L

Material: Chromium molybdenum steel
Surface treatment: Zinc chromated

Single Acting, Spring Return

Cylinder model	C	D	Mounting bolt part no.
CDQSB12-5S	6.5	30	CQ-M3 x 30L
		35	x 35L
CDQSB16-5S	6.5	30	CQ-M3 x 30L
		35	x 35L
CDQSB20-5S	6.5	35	CQ-M5 x 35L
		40	x 40L
CDQSB25-5S	8.5	40	CQ-M5 x 40L
		45	45L

Single Acting, Spring Extend

Cylinder model	C	D	Mounting bolt part no.
CDQSB12-5T	6.5	30	CQ-M3 x 30L
		35	x 35L
CDQSB16-5T	6.5	30	CQ-M3 x 30L
		35	x 35L
CDQSB20-5T	6.5	35	CQ-M5 x 35L
		40	x 40L
CDQSB25-5T	8.5	40	CQ-M5 x 40L
		45	x 45L

Material: Chromium molybdenum steel
Surface treatment: Zinc chromated

Construction

Single acting, Spring return

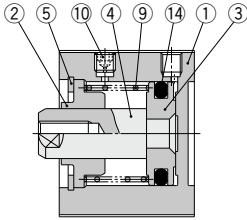

Single acting, Spring return/With auto switch (Built-in magnet) ø12, 16

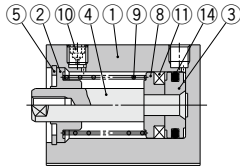

ø20, 25

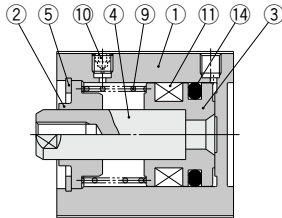

Single acting, Spring extend

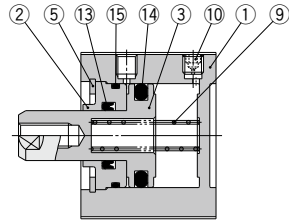

Single acting, Spring extend/With auto switch (Built-in magnet) ø12, 16

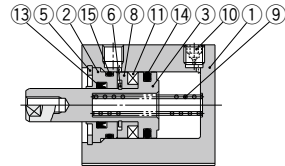

ø20, 25

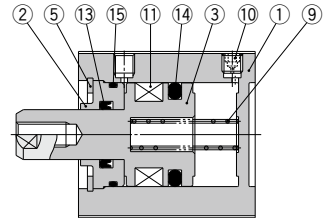

Component Parts

No.	Description	Material	Note
1	Cylinder tube	Aluminum alloy	Hard anodized
2	Collar	Aluminum alloy	Anodized
3	Piston	Aluminum alloy	Single acting, Spring return
		Stainless steel	Single acting, Spring extend
4	Piston rod	Stainless steel	
5	Retaining ring	Carbon tool steel	Phosphate coated
6	Retaining ring	Carbon tool steel	Nickel plated
7	Rod end nut	Carbon steel	Zinc chromated
8	Spacer for switch type	Aluminum alloy	Chromated
9	Return spring	Piano wire	Zinc chromated
10	Plug with fixed orifice	Alloy steel	Nickel plated
11	Magnet	—	
12	Centering location ring	Aluminum alloy	Anodized
13*	Rod seal	NBR	
14*	Piston seal	NBR	
15*	Tube gasket	NBR	

Replacement Parts/Seal Kit Single acting, Spring return

Bore size (mm)	Kit no.	Contents
12	CQSB12-S-PS	Set of nos. above ⑭
16	CQSB16-S-PS	
20	CQSB20-S-PS	
25	CQSB25-S-PS	

* Seal kit includes ⑬. Order the seal kit, based on each bore size.
* Since the seal kit does not include a grease pack, order it separately.
Grease pack part no.: GR-S-010 (10 g)

Rod end male thread

Single acting, Spring return
Single acting, Spring extend

With boss on head end

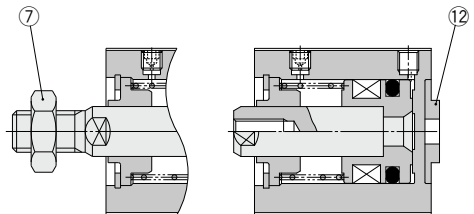

Replacement Parts/Seal Kit Single acting, Spring extend

Bore size (mm)	Kit no.	Contents
12	CQSB12-T-PS	Set of nos. above ⑬, ⑭, ⑮
16	CQSB16-T-PS	
20	CQSB20-T-PS	
25	CQSB25-T-PS	

* Seal kit includes ⑬, ⑭, ⑮. Order the seal kit, based on each bore size.
* Since the seal kit does not include a grease pack, order it separately.
Grease pack part no.: GR-S-010 (10 g)

CUJ

CU

CQS

JCQ

CQ2

RQ

CQM

CQU

MU

D-□

-X□

Technical Data

CQS Series

Dimensions: $\phi 12$ to $\phi 25$ /Single Acting, Spring Return

Basic type (Through-hole/Both ends tapped common): CQSB/CDQSB

$\phi 12$

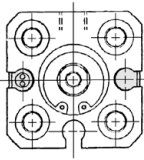

$\phi 16$

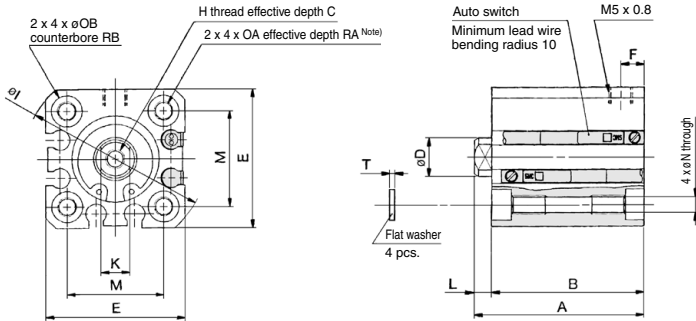

$\phi 20, \phi 25$

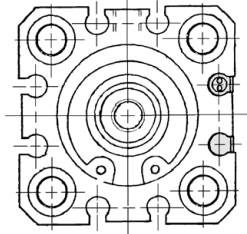

Rod end male thread

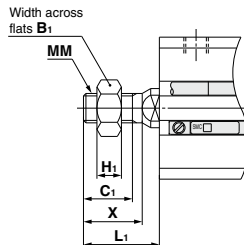

With boss on head end

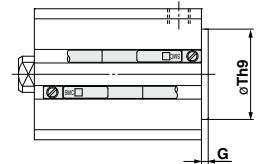

Rod End Male Thread

Bore size (mm)	B ₁	C ₁	H ₁	L ₁	MM	X
12	8	9	4	14	M5 x 0.8	10.5
16	10	10	5	15.5	M6 x 1.0	12
20	13	12	5	18.5	M8 x 1.25	14
25	17	15	6	22.5	M10 x 1.25	17.5

With Boss on Head End (mm)

Bore size (mm)	G	Th9
12	1.5	15 ⁰ _{-0.043}
16	1.5	20 ⁰ _{-0.052}
20	2	13 ⁰ _{-0.043}
25	2	15 ⁰ _{-0.043}

Note) With boss on rod end : Option (Suffix *-XC36* to the end of part number.)

Basic Type

Bore size (mm)	Stroke range (mm)	Without auto switch				With auto switch				C	D	E	F	H	I	K	L	M	N	OA	OB	RA	RB	T
		A	B	A	B																			
		5 ST	10 ST	5 ST	10 ST	5 ST	10 ST	5 ST	10 ST															
12	5, 10	25.5	30.5	22	27	30.5	35.5	27	32	6	6	25	5	M3 x 0.5	32	5	3.5	15.5	3.5	M4 x 0.7	6.5	7	4	0.5
16		25.5	30.5	22	27	30.5	35.5	27	32	8	8	29	5	M4 x 0.7	38	6	3.5	20	3.5	M4 x 0.7	6.5	7	4	0.5
20		29	34	24.5	29.5	39	44	34.5	39.5	7	10	36	5.5	M5 x 0.8	47	8	4.5	25.5	5.4	M6 x 1.0	9	10	7	1
25		32.5	37.5	27.5	32.5	42.5	47.5	37.5	42.5	12	12	40	5.5	M6 x 1.0	52	10	5	28	5.4	M6 x 1.0	9	10	7	1

Note) For basic type $\phi 12$ and $\phi 16$ with 5 stroke, through-hole is threaded over the entire length.

For basic type $\phi 20, \phi 25$ with 5 and 10 stroke, through-hole is threaded over the entire length.

With auto switch (Built-in magnet)/ $\phi 20$; 5 stroke.

* For details about the rod end nut and accessory brackets, refer to page 796.

Dimensions: $\varnothing 12$ to $\varnothing 25$ /Single Acting, Spring Return

Foot type: CQSL/CDQSL

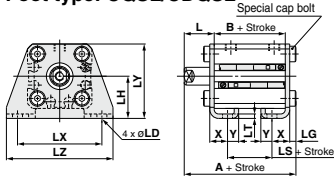

Foot Type

Bore size (mm)	Stroke range (mm)	Without auto switch			With auto switch			L	L ₁	LD	LG	LH	LT	LX	LY	LZ	X	Y
		A	B	LS	A	B	LS											
12	5, 10	35.3	17	5	40.3	22	10	13.5	24	4.5	2.8	17	2	34	29.5	44	8	4.5
16		35.3	17	5	40.3	22	10	13.5	25.5	4.5	2.8	19	2	38	33.5	48	8	5
20		41.2	19.5	7.5	51.2	29.5	17.5	14.5	28.5	6.6	4	24	3.2	48	42	62	9.2	5.8
25		44.7	22.5	7.5	54.7	32.5	17.5	15	32.5	6.6	4	26	3.2	52	46	66	10.7	5.8

Foot bracket material: Carbon steel
Surface treatment: Nickel plated

Rod end male thread

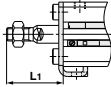

Compact foot type: CQSLC/CDQSLC

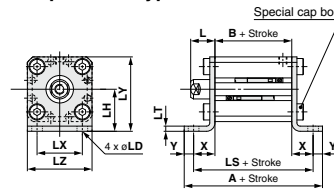

Compact Foot Type

Bore size (mm)	Stroke range (mm)	Without auto switch			With auto switch			L	L ₁	LD	LH	LT	LX	LY	LZ	X	Y
		A	B	LS	A	B	LS										
12	5, 10	44.6	17	35.6	49.6	22	40.6	13.5	24	4.5	17	2	15.5	29.5	25	9.3	4.5
16		45.6	17	35.6	50.6	22	40.6	13.5	25.5	4.5	19	2	20	33.5	29	9.3	5
20		57.5	19.5	45.9	67.5	29.5	55.9	14.5	28.5	6.6	24	3.2	25.5	42	36	13.2	5.8
25		60.5	22.5	48.9	70.5	32.5	58.9	15	32.5	6.6	26	3.2	28	46	40	13.2	5.8

Compact foot bracket material: Carbon steel
Surface treatment: Zinc chromated

Rod end male thread

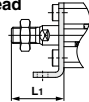

Rod side flange type: CQSF/CDQSF

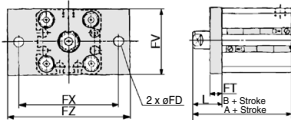

Rod Side Flange Type

Bore size (mm)	Stroke range (mm)	Without auto switch		With auto switch		FD	FT	FV	FX	FZ	L	L ₁
		A	B	A	B							
12	5, 10	30.5	17	35.5	22	4.5	5.5	25	45	55	13.5	24
16		30.5	17	35.5	22	4.5	5.5	30	45	55	13.5	25.5
20		34	19.5	44	29.5	6.6	8	39	48	60	14.5	28.5
25		37.5	22.5	47.5	32.5	6.6	8	42	52	64	15	32.5

Flange bracket material: Carbon steel
Surface treatment: Nickel plated

Rod end male thread

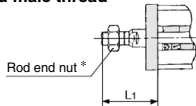

Head side flange type: CQSG/CDQSG

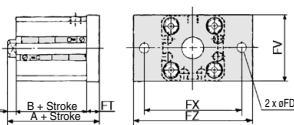

Head Side Flange Type

Bore size (mm)	Stroke range (mm)	Without auto switch		With auto switch		FD	FT	FV	FX	FZ	L	L ₁
		A	B	A	B							
12	5, 10	26	17	31	22	4.5	5.5	25	45	55	3.5	14
16		26	17	31	22	4.5	5.5	30	45	55	3.5	15.5
20		32	19.5	42	29.5	6.6	8	39	48	60	4.5	18.5
25		35.5	22.5	45.5	32.5	6.6	8	42	52	64	5	22.5

Flange bracket material: Carbon steel
Surface treatment: Nickel plated

Rod end male thread

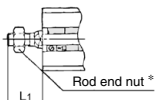

* For details about the rod end nut and accessory brackets, refer to page 796.

CQS Series

Dimensions: $\varnothing 12$ to $\varnothing 25$ /Single Acting, Spring Return

Double clevis type: CQSD/CDQSD

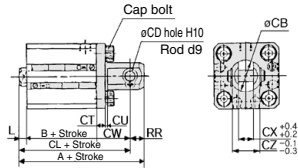

Rod end male thread

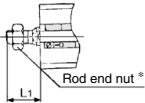

Double Clevis Type

Bore size (mm)	Stroke range (mm)	Without auto switch			With auto switch			CB	CD	CT	CU	CW	CX	CZ	L	L ₁	RR
		A	B	CL	A	B	CL										
12	5, 10	40.5	17	34.5	45.5	22	39.5	12	5	4	7	14	5	10	3.5	14	6
16		41.5	17	35.5	46.5	22	40.5	14	5	4	10	15	6.5	12	3.5	15.5	6
20		51	19.5	42	61	29.5	52	20	8	5	12	18	8	16	4.5	18.5	9
25		57.5	22.5	47.5	67.5	32.5	57.5	24	10	5	14	20	10	20	5	22.5	10

Double clevis bracket material: Carbon steel
Surface treatment: Nickel plated

* For details about the double clevis pivot bracket, refer to page 705.

* For details about the rod end nut and accessory brackets, refer to page 796.

Dimensions: $\phi 12$ to $\phi 25$ /Single Acting, Spring Extend

Basic type (Through-hole/Both ends tapped common): CQSB/CDQSB

$\phi 12$

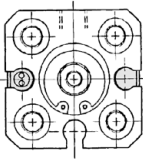

$\phi 16$

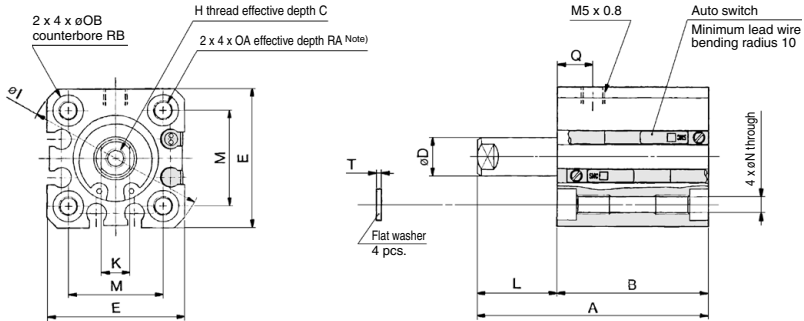

$\phi 20, \phi 25$

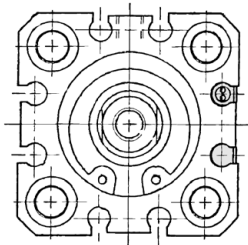

Rod end male thread

Width across flats **B₁**

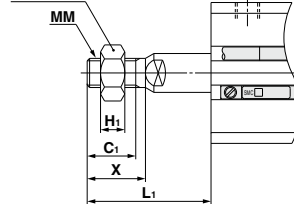

With boss on head end

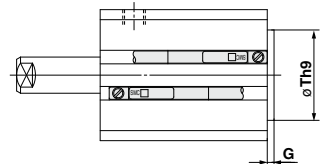

Rod End Male Thread

Bore size (mm)	B ₁	C ₁	H ₁	L ₁		MM	X
				5 ST	10 ST		
12	8	9	4	19	24	M5 x 0.8	10.5
16	10	10	5	20.5	25.5	M6 x 1.0	12
20	13	12	5	23.5	28.5	M8 x 1.25	14
25	17	15	6	27.5	32.5	M10 x 1.25	17.5

With Boss on Head End (mm)

Bore size (mm)	G	Th9
12	1.5	15 ⁰ _{-0.043}
16	1.5	20 ⁰ _{-0.052}
20	2	13 ⁰ _{-0.043}
25	2	15 ⁰ _{-0.043}

Note) With boss on rod end : Option (Suffix *-XC36* to the end of part number.)

Basic Type

Bore size (mm)	Stroke range (mm)	Without auto switch				With auto switch				C	D	E	H	I	K	L		M	N	OA	OB	Q	RA	RB	T
		A	B	A	B	5 ST	10 ST																		
		5 ST	10 ST	5 ST	10 ST	5 ST	10 ST																		
12	5, 10	30.5	40.5	22	27	35.5	45.5	27	32	6	6	25	M3 x 0.5	32	5	8.5	13.5	15.5	3.5	M4 x 0.7	6.5	7.5	7	4	0.5
		30.5	40.5	22	27	35.5	45.5	27	32	8	8	29	M4 x 0.7	38	6	8.5	13.5	20	3.5	M4 x 0.7	6.5	7.5	7	4	0.5
		34	44	24.5	29.5	44	54	34.5	39.5	7	10	36	M5 x 0.8	47	8	9.5	14.5	25.5	5.4	M6 x 1.0	9	8	10	7	1
20	5, 10	37.5	47.5	27.5	32.5	47.5	57.5	37.5	42.5	12	12	40	M6 x 1.0	52	10	10	15	28	5.4	M6 x 1.0	9	9	10	7	1
25		37.5	47.5	27.5	32.5	47.5	57.5	37.5	42.5	12	12	40	M6 x 1.0	52	10	10	15	28	5.4	M6 x 1.0	9	9	10	7	1
25		37.5	47.5	27.5	32.5	47.5	57.5	37.5	42.5	12	12	40	M6 x 1.0	52	10	10	15	28	5.4	M6 x 1.0	9	9	10	7	1

Note) For basic type $\phi 12$ and $\phi 16$ with 5 stroke, through-hole is threaded over the entire length.
For basic type $\phi 20, \phi 25$ with 5 and 10 stroke, through-hole is threaded over the entire length.
With auto switch (Built-in magnet)/ $\phi 20; 5$ stroke.

* For details about the rod end nut and accessory brackets, refer to page 796.

- CUJ
- CU
- CQS**
- JCQ
- CQ2
- RQ
- CQM
- CQU
- MU

D-□
-X□
Technical Data

CQS Series

Dimensions: $\varnothing 12$ to $\varnothing 25$ /Single Acting, Spring Extend

Foot type: CQSL/CDQSL

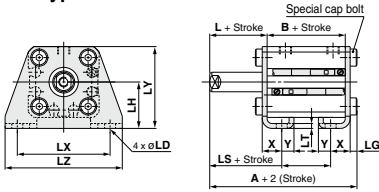

Rod end male thread

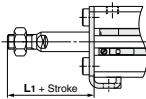

Foot Type

Bore size (mm)	Stroke range (mm)	Without auto switch			With auto switch		
		A	B	LS	A	B	LS
12	5, 10	35.3	17	5	40.3	22	10
16		35.3	17	5	40.3	22	10
20		41.2	19.5	7.5	51.2	29.5	17.5
25		44.7	22.5	7.5	54.7	32.5	17.5

Bore size (mm)	L	L ₁	LD	LG	LH	LT	LX	LY	LZ	X	Y
12	13.5	24	4.5	2.8	17	2	34	29.5	44	8	4.5
16	13.5	25.5	4.5	2.8	19	2	38	33.5	48	8	5
20	14.5	28.5	6.6	4	24	3.2	48	42	62	9.2	5.8
25	15	32.5	6.6	4	26	3.2	52	46	66	10.7	5.8

Foot bracket material: Carbon steel
Surface treatment: Nickel plated

Compact foot type: CQSLC/CDQSLC

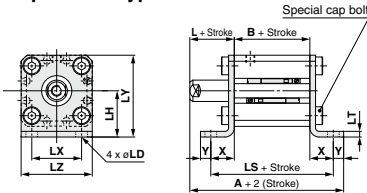

Rod end male thread

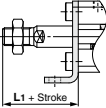

Compact Foot Type

Bore size (mm)	Stroke range (mm)	Without auto switch			With auto switch		
		A	B	LS	A	B	LS
12	5, 10	44.3	17	35.6	49.3	22	40.6
16		44.8	17	35.6	49.8	22	40.6
20		53	19.5	45.9	63	29.5	55.9
25		56.5	22.5	48.9	66.5	32.5	58.9

Bore size (mm)	L	L ₁	LD	LH	LT	LX	LY	LZ	X	Y
12	13.5	24	4.5	17	2	15.5	29.5	25	9.3	4.5
16	13.5	25.5	4.5	19	2	20	33.5	29	9.3	5
20	14.5	28.5	6.6	24	3.2	25.5	42	36	13.2	5.8
25	15	32.5	6.6	26	3.2	28	46	40	13.2	5.8

Compact foot bracket material: Carbon steel
Surface treatment: Zinc chromated

Rod side flange type: CQSF/CDQSF

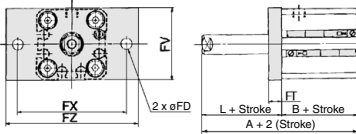

Rod end male thread

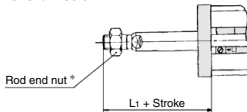

Rod Side Flange Type

Bore size (mm)	Stroke range (mm)	Without auto switch		With auto switch		FD	FT	FV	FX	FZ	L	L ₁
		A	B	A	B							
12	5, 10	30.5	17	35.5	22	4.5	5.5	25	45	55	13.5	24
16		30.5	17	35.5	22	4.5	5.5	30	45	55	13.5	25.5
20		34	19.5	44	29.5	6.6	8	39	48	60	14.5	28.5
25		37.5	22.5	47.5	32.5	6.6	8	42	52	64	15	32.5

Flange bracket material: Carbon steel
Surface treatment: Nickel plated

Head side flange type: CQSG/CDQSG

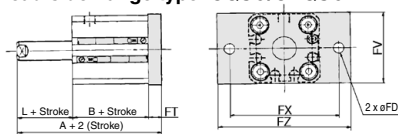

Rod end male thread

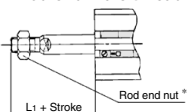

Head Side Flange Type

Bore size (mm)	Stroke range (mm)	Without auto switch		With auto switch		FD	FT	FV	FX	FZ	L	L ₁
		A	B	A	B							
12	5, 10	26	17	31	22	4.5	5.5	25	45	55	3.5	14
16		26	17	31	22	4.5	5.5	30	45	55	3.5	15.5
20		32	19.5	42	29.5	6.6	8	39	48	60	4.5	18.5
25		35.5	22.5	45.5	32.5	6.6	8	42	52	64	5	22.5

Flange bracket material: Carbon steel
Surface treatment: Nickel plated

* For details about the rod end nut and accessory brackets, refer to page 796.

Dimensions: $\varnothing 12$ to $\varnothing 25$ /Single Acting, Spring Extend

Double clevis type: CQSD/CDQSD

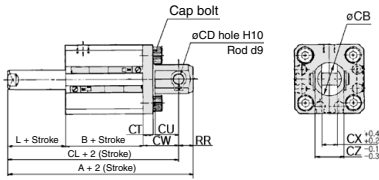

Rod end male thread

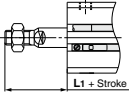

Double Clevis Type

Bore size (mm)	Stroke range (mm)	Without auto switch			With auto switch						
		A	B	CL	A	B	CL				
12	5, 10	40.5	17	34.5	45.5	22	39.5				
16		41.5	17	35.5	46.5	22	40.5				
20		51	19.5	42	61	29.5	52				
25		57.5	22.5	47.5	67.5	32.5	57.5				
Bore size (mm)		CB	CD	CT	CU	CW	CX	CZ	L	L ₁	RR
12		12	5	4	7	14	5	10	3.5	14	6
16		14	5	4	10	15	6.5	12	3.5	15.5	6
20		20	8	5	12	18	8	16	4.5	18.5	9
25		24	10	5	14	20	10	20	5	22.5	10

Double clevis bracket material: Carbon steel
Surface treatment: Nickel plated

* For details about the rod end nut and accessory brackets, refer to page 796.

CJ

CU

CQS

JCQ

CQ2

RQ

CQM

CQU

MU

D-□

-X□

Technical Data

Compact Cylinder: Non-rotating Rod Type Double Acting, Single Rod

CQSK Series

ø12, ø16, ø20, ø25

How to Order

CQSK **B** **20** - **30** **D** **□** - **□**

With auto switch **CDQSK** **B** **20** - **30** **D** **□** - **M9BW** **□** - **□**

With auto switch
(Built-in magnet)

Mounting type

B	Through-hole/Both ends tapped common (Standard)
L	Foot type
LC	Compact foot type
F	Rod side flange type
G	Head side flange type
D	Double clevis type

Bore size

12	12 mm
16	16 mm
20	20 mm
25	25 mm

Number of auto switches

Nil	2 pcs.
S	1 pc.
n	"n" pcs.

Auto switch

Nil	Without auto switch
------------	---------------------

* Refer to the table below for the applicable auto switch model.

Body option

Nil	Standard (Rod end female thread)
M	Rod end male thread
F	Boss on head side

* Combination of body options is available. FM

Standard Stroke

Bore size (mm)	Standard stroke (mm)
12, 16	5, 10, 15, 20, 25, 30
20, 25	5, 10, 15, 20, 25, 30, 35, 40, 45, 50

Cylinder stroke (mm)

Action

D	Double acting
----------	---------------

Built-in Magnet Cylinder Model

If a built-in magnet cylinder without an auto switch is required, there is no need to enter the symbol for the auto switch.
(Example) CDQSKL25-30D

Made to Order
Refer to page 725 for details.

* Mounting brackets are shipped together (but not assembled).
* Cylinder mounting bolts are not included. Order them separately referring to "Mounting Bolt for CQSK" on page 728.

Applicable Auto Switches

Refer to pages 1575 to 1701 for further information on auto switches.

Type	Special function	Electrical entry	Indicator light	Wiring (Output)	Load voltage		Auto switch model		Lead wire length (m)				Pre-wired connector	Applicable load	
					DC	AC	Perpendicular	In-line	0.5 (Nil)	1 (M)	3 (L)	5 (Z)			
Solid state auto switch	—	Grommet	Yes	3-wire (NPN)	24 V	5 V, 12 V	—	M9NV	M9N	●	●	●	○	IC circuit	Relay, PLC
				3-wire (PNP)				M9PV	M9P	●	●	●	○		
				2-wire	5 V, 12 V	M9BV	M9B	●	●	●	○				
				3-wire (NPN)		M9NWV	M9NW	●	●	●	○				
	Diagnostic indication (2-color indicator)	Grommet	Yes	3-wire (PNP)	24 V	5 V, 12 V	—	M9PWV	M9PW	●	●	●	○	IC circuit	Relay, PLC
				2-wire				M9BWV	M9BW	●	●	●	○		
				3-wire (NPN)	5 V, 12 V	M9NAV ^{*1}	M9NA ^{*1}	○	○	○	○				
				3-wire (PNP)		M9PAV ^{*1}	M9PA ^{*1}	○	○	●	○				
Water resistant (2-color indicator)	Grommet	Yes	2-wire	24 V	12 V	—	M9BAV ^{*1}	M9BA ^{*1}	○	○	●	○	IC circuit	Relay, PLC	
			3-wire (NPN equivalent)				5 V	A96V	A96	●	●	●			—
Reed auto switch	—	Grommet	No	2-wire	24 V	12 V	100 V or less	A93V ^{*2}	A93	●	●	●	—	IC circuit	Relay, PLC
				3-wire				5 V	A96V	A96	●	●	●		

*1 Water resistant type auto switches can be mounted on the above models, but in such case SMC cannot guarantee water resistance.

Consult with SMC regarding water resistant types with the above model numbers.

*2 1 m type lead wire is only applicable to D-A93.

* Lead wire length symbols: 0.5 m..... Nil (Example) M9NW
1 m..... M (Example) M9NWM
3 m..... L (Example) M9NWL
5 m..... Z (Example) M9NZW

* Solid state auto switches marked with "○" are produced upon receipt of order.

* Since there are other applicable auto switches than listed, refer to page 749 for details.

* For details about auto switches with pre-wired connector, refer to pages 1648 and 1649.

* Auto switches are shipped together (not assembled).

Note) There is the case D-A9□V/M9□V/M9□WV/M9□AV type auto switches cannot be mounted on the port surface, depending on the cylinder's stroke and the fitting size for piping. Consult with SMC for details.

Compact Cylinder: Non-rotating Rod Type **CQSK Series**



Symbol

Without cushion

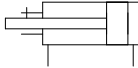

Made to Order:
Individual Specifications
(For details, refer to page 752.)

Symbol	Specifications
-X1876	With conave shape end boss on the cylinder tube head side

Made to Order Specifications

[Click here for details](#)

Symbol	Specifications
-XA□	Change of Rod End Shape
-XC6	Piston rod and rod end nut made of stainless steel
-XC8	Adjustable stroke cylinder/Adjustable extension type
-XC9	Adjustable stroke cylinder/Adjustable retraction type
-XC10	Dual stroke cylinder/Double rod type
-XC11	Dual stroke cylinder/Single rod type

Body Option

Description	Application
Rod end male thread	Available for all non-rotating rod type.

Mounting Bracket Part No.

Bore size (mm)	Foot (1)	Compact foot (1)	Flange	Double clevis
12	CQSK-L012	CQSK-LC012	CQSK-F012	CQSK-D012
16	CQSK-L016	CQSK-LC016	CQSK-F016	CQSK-D016
20	CQSK-L020	CQSK-LC020	CQSK-F020	CQSK-D020
25	CQSK-L025	CQSK-LC025	CQSK-F025	CQSK-D025

Note 1) When ordering foot and compact foot brackets, order 2 pieces per cylinder.

Note 2) Parts belonging to each bracket are as follows.

Foot, Compact foot, Flange type: Body mounting bolt
Double clevis type: Clevis pin, Type C retaining ring for axis, Body mounting bolt.

Moisture Control Tube IDK Series



When operating an actuator with a small diameter and a short stroke at a high frequency, the dew condensation (water droplet) may occur inside the piping depending on the conditions.

Simply connecting the moisture control tube to the actuator will prevent dew condensation from occurring. For details, refer to [the IDK series in the Best Pneumatics No. 6.](#)

Standard Specifications

Bore size (mm)	12	16	20	25
Action	Double acting, Single rod			
Fluid	Air			
Lubrication	Not required (Non-lube)			
Proof pressure	1.5 MPa			
Maximum operating pressure	1.0 MPa			
Minimum operating pressure	0.07 MPa		0.05 MPa	
Ambient and fluid temperature	Without auto switch: -10 to 70°C (No freezing)			
	With auto switch: -10 to 60°C (No freezing)			
Cushion	None			
Rod end thread	Female thread			
Stroke length tolerance	+1.0 mm 0			
Piston speed	50 to 500 mm/s			
Allowable kinetic energy (J)	0.022	0.038	0.055	0.09
Rod non-rotating accuracy	±1°		±0.7°	

Theoretical Output

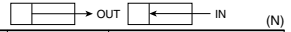

Bore size (mm)	Rod width across flats (mm)	Action	Piston area (mm ²)	Operating pressure (MPa)		
				0.3	0.5	0.7
12	5.2	IN	90	27	45	63
		OUT	113	34	57	79
16	6.2	IN	168	50	84	117
		OUT	201	60	101	141
20	8.2	IN	256	77	128	179
		OUT	314	94	157	220
25	10.2	IN	401	120	200	281
		OUT	491	147	245	344

Manufacture of Intermediate Stroke

Description	Spacer is installed in the standard stroke body.		
Part no.	Refer to "How to Order" for the standard model no. (page 724).		
Standard stroke	Description Stroke range	Intermediate strokes in 1 mm increments are available by using spacers with standard stroke cylinders.	
		Bore size	Stroke range
		12, 16	1 to 29
		20, 25	1 to 49
Example	Part no.: CQSKB25-47D CQSKB25-50D with 3 mm width spacer inside. B dimension is 77.5 mm.		

Refer to pages 747 to 749 for cylinders with auto switches.

- Minimum auto switch mounting stroke
- Proper auto switch mounting position (detection at stroke end) and mounting height
- Operating range

CUJ

CU

CQS

JCQ

CQ2

RQ

CQM

CQU

MU

D-□

-X□

Technical Data

CQSK Series

Weight/Without Auto Switch

(g)

Bore size (mm)	Cylinder stroke (mm)									
	5	10	15	20	25	30	35	40	45	50
12	39	46	53	60	67	74	—	—	—	—
16	52	61	69	78	86	95	—	—	—	—
20	89	102	116	129	143	156	170	183	197	211
25	124	141	157	174	190	207	224	240	257	273

Calculation: (Example) **CQSKF20-5DM**

- Cylinder weight: CQSKB20-5D..... 89 g
- Additional weight: Rod end male thread..... 10 g
- : Rod side flange type142 g
- 241 g

Weight/With Auto Switch (Built-in magnet)

(g)

Bore size (mm)	Cylinder stroke (mm)									
	5	10	15	20	25	30	35	40	45	50
12	47	54	62	69	76	83	—	—	—	—
16	63	71	80	88	97	106	—	—	—	—
20	122	136	149	163	176	190	203	217	230	244
25	168	185	201	218	235	251	268	284	301	317

Additional Weight

(g)

Bore size (mm)		12	16	20	25
Rod end male thread	Male thread	1.5	3	6	12
	Nut	1	2	4	8
With boss on head end		0.7	1.3	2	3
Foot type (Including mounting bolt)		55	64	158	179
Compact foot type (Including mounting bolt)		41	51	121	140
Rod side flange type (Including mounting bolt)		58	69	142	178
Head side flange type (Including mounting bolt)		56	66	137	171
Double clevis type (Including pin, retaining ring, bolt)		34	40	92	127

Construction

Basic type

ø12

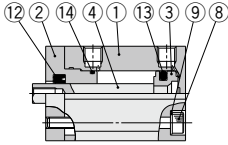

With auto switch (Built-in magnet)

ø12

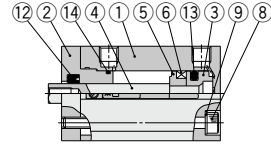

ø16, ø20, ø25

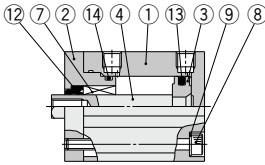

ø16

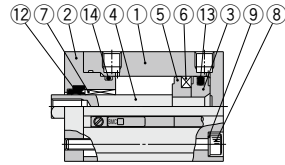

Rod end male thread

With boss on head end

ø20, ø25

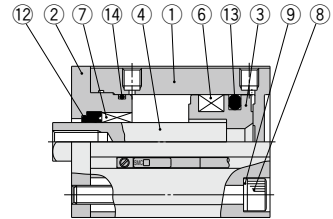
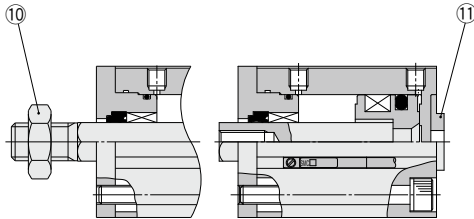

Component Parts

No.	Description	Material	Note
1	Cylinder tube	Aluminum alloy	Hard anodized
2	Rod cover	Aluminum alloy	Anodized
3	Piston	Aluminum alloy	
4	Piston rod	Stainless steel	
5	Spacer for switch type	Aluminum alloy	Chromated
6	Magnet	—	
7	Non-rotating guide	Oil impregnated sintered alloy	ø16, ø20 and ø25
8	Hexagon socket head cap screw	Alloy steel	Nickel plated
9	Plain washer	Rolled steel	Nickel plated
10	Rod end nut	Carbon steel	Zinc chromated
11	Centering location ring	Aluminum alloy	Anodized
12*	Rod seal	NBR	
13*	Piston seal	NBR	
14*	Tube gasket	NBR	

Replacement Parts/Seal Kit

Bore size (mm)	Kit no.	Contents
12	CQSKB12-PS	Set of nos. above 12, 13, 14.
16	CQSKB16-PS	
20	CQSKB20-PS	
25	CQSKB25-PS	

* Seal kit includes 12, 13, 14. Order the seal kit, based on each bore size.

* Since the seal kit does not include a grease pack, order it separately.

Grease pack part no.: GR-S-010 (10 g)

⚠ Precautions

Operating Precautions

⚠ Caution

- Any kind of operation producing rotational torque to piston rod must be considered. The non-rotating guide would be deformed and the accuracy would be compromised. Refer to the table below for rotation torque allowance.

Allowable rotational torque (N-m) or less	ø12	ø16	ø20	ø25
	0.04	0.04	0.2	0.25

- Load to piston rod must always be in an axial direction.
- When a workpiece is secured to the end of the piston rod, ensure that the piston rod is retracted entirely, and place a wrench on the portion of the rod that protrudes beyond the section. Also, tighten by giving consideration to prevent the tightening torque from being applied to the non-rotating guide.

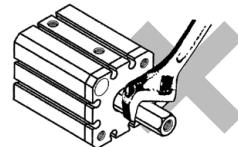

CJ

CU

CQS

JCQ

CQ2

RQ

CQM

CQU

MU

D-□

-X□

Technical Data

CQSK Series

Mounting Bolt for CQSK

Mounting method: Mounting bolt for through-hole mounting type of CQSK is available as an option.

Refer to the following for ordering procedures.
Order the actual number of bolts that will be used.

Example) CQ-M3x25L 2 pcs.

Head side mounting type

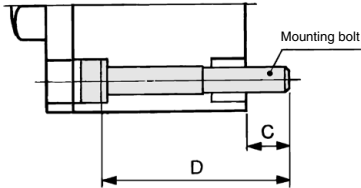

Rod side mounting type

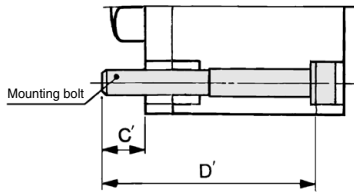

Note) When mounting a cylinder with through-hole, be sure to use the attached plain washer.

Cylinder model	C	D	Mounting bolt part no.	C'	D'	Mounting bolt part no.
CQSKB12-5D	6.5	25	CQ-M3 x 25L	6.5	30	CQ-M3 x 30L
-10D		30	x 35L		35	x 35L
-15D		35	x 35L		40	x 40L
-20D		40	x 40L		45	x 45L
-25D		45	x 45L		50	x 50L
-30D		50	x 50L		55	x 55L
CQSKB16-5D	6.5	25	CQ-M3 x 25L	6.5	30	CQ-M3 x 30L
-10D		30	x 30L		35	x 35L
-15D		35	x 35L		40	x 40L
-20D		40	x 40L		45	x 45L
-25D		45	x 45L		50	x 45L
-30D		50	x 50L		55	x 55L
CQSKB20-5D	6.5	25	CQ-M5 x 25L	6.5	30	CQ-M5 x 30L
-10D		30	x 30L		35	x 35L
-15D		35	x 35L		40	x 40L
-20D		40	x 40L		45	x 45L
-25D		45	x 45L		50	x 50L
-30D		50	x 50L		55	x 55L
-35D	55	x 55L	60	x 60L		
-40D	60	x 60L	65	x 65L		
-45D	65	x 65L	70	x 70L		
-50D	70	x 70L	75	x 75L		
CQSKB25-5D	8.5	30	CQ-M5 x 30L	8.5	35	CQ-M5 x 35L
-10D		35	x 35L		40	x 40L
-15D		40	x 40L		45	x 45L
-20D		45	x 45L		50	x 50L
-25D		50	x 50L		55	x 55L
-30D		55	x 55L		60	x 60L
-35D	60	x 60L	65	x 65L		
-40D	65	x 65L	70	x 70L		
-45D	70	x 70L	75	x 75L		
-50D	75	x 75L	80	x 80L		

Material: Chromium molybdenum steel
Surface treatment: Zinc chromated

Mounting Bolt for CDQSK

Mounting method: Mounting bolt for through-hole mounting type of CDQSK is available as an option.

Refer to the following for ordering procedures.
Order the actual number of bolts that will be used.

Example) CQ-M3x30L 2 pcs.

Head side mounting type

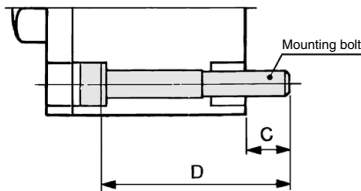

Rod side mounting type

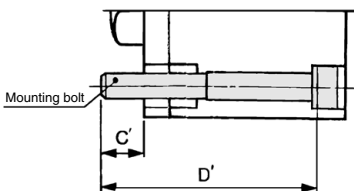

Note) When mounting a cylinder with through-hole, be sure to use the attached plain washer.

Cylinder model	C	D	Mounting bolt part no.	C'	D'	Mounting bolt part no.
CDQSKB12-5D	6.5	30	CQ-M3 x 30L	6.5	35	CQ-M3 x 35L
-10D		35	x 35L		40	x 40L
-15D		40	x 40L		45	x 45L
-20D		45	x 45L		50	x 50L
-25D		50	x 50L		55	x 55L
-30D		55	x 55L		60	x 60L
CDQSKB16-5D	6.5	30	CQ-M3 x 30L	6.5	35	CQ-M3 x 35L
-10D		35	x 35L		40	x 40L
-15D		40	x 40L		45	x 45L
-20D		45	x 45L		50	x 50L
-25D		50	x 50L		55	x 55L
-30D		55	x 55L		60	x 60L
CDQSKB20-5D	6.5	35	CQ-M5 x 35L	6.5	40	CQ-M5 x 40L
-10D		40	x 40L		45	x 45L
-15D		45	x 45L		50	x 50L
-20D		50	x 50L		55	x 55L
-25D		55	x 55L		60	x 60L
-30D		60	x 60L		65	x 65L
-35D	65	x 65L	70	x 70L		
-40D	70	x 70L	75	x 75L		
-45D	75	x 75L	80	x 80L		
-50D	80	x 80L	85	x 85L		
CDQSKB25-5D	8.5	40	CQ-M5 x 40L	8.5	45	CQ-M5 x 45L
-10D		45	x 45L		50	x 50L
-15D		50	x 50L		55	x 55L
-20D		55	x 55L		60	x 60L
-25D		60	x 60L		65	x 65L
-30D		65	x 65L		70	x 70L
-35D	70	x 70L	75	x 75L		
-40D	75	x 75L	80	x 80L		
-45D	80	x 80L	85	x 85L		
-50D	85	x 85L	90	x 90L		

Material: Chromium molybdenum steel
Surface treatment: Zinc chromated

Dimensions: $\phi 12$ to $\phi 25$

Basic type (Through-hole/Both ends tapped common): CQSK/CDQSK

* For the auto switch mounting position and its mounting height, refer to page 748.

$\phi 12$

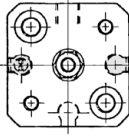

$\phi 16$

2 x 2 x ϕ OB counterbore
2 x 2 x OA effective depth RA (Note)

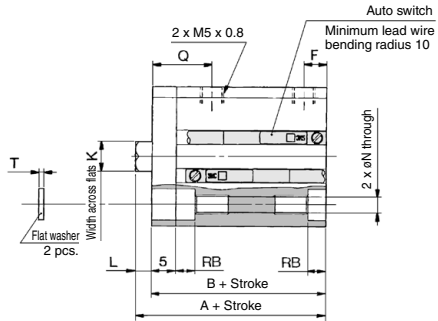
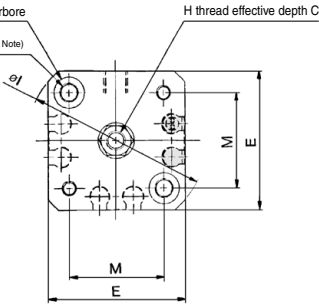

$\phi 20, \phi 25$

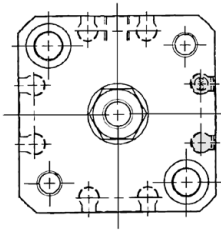

Rod end male thread

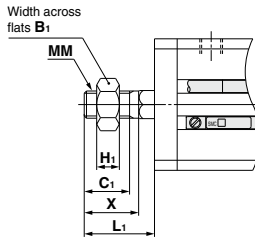

With boss on head end

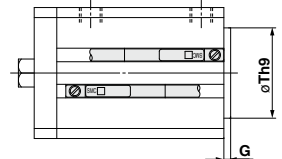

Rod End Male Thread

Bore size (mm)	B ₁	C ₁	H ₁	L ₁	MM	X
12	8	9	4	14	M5 x 0.8	10.5
16	10	10	5	15.5	M6 x 1.0	12
20	13	12	5	18.5	M8 x 1.25	14
25	17	15	6	22.5	M10 x 1.25	17.5

With Boss on Head End (mm)

Bore size (mm)	G	Th9
12	1.5	15 ⁰ _{-0.043}
16	1.5	20 ⁰ _{-0.052}
20	2	13 ⁰ _{-0.043}
25	2	15 ⁰ _{-0.043}

Basic Type

Bore size (mm)	Stroke range (mm)	Without auto switch		With auto switch		C	E	F	H	I	K	L	M	N	OA	OB	Q	RA	RB	T
		A	B	A	B															
12	5 to 30	25.5	22	30.5	27	6	25	5	M3 x 0.5	32	5.2	3.5	15.5	3.5	M4 x 0.7	6.5	12.5	7	4	0.5
16	5 to 30	25.5	22	30.5	27	8	29	5	M4 x 0.7	38	6.2	3.5	20	3.5	M4 x 0.7	6.5	12.5	7	4	0.5
20	5 to 50	29	24.5	39	34.5	7	36	5.5	M5 x 0.8	47	8.2	4.5	25.5	5.4	M6 x 1.0	9	13	10	7	1
25	5 to 50	32.5	27.5	42.5	37.5	12	40	5.5	M6 x 1.0	52	10.2	5	28	5.4	M6 x 1.0	9	14	10	7	1

Note) For basic type $\phi 12$ and $\phi 16$ with 5 stroke, through-hole is threaded over the entire length.

For basic type $\phi 20$ with 5 to 15 stroke, through-hole is threaded over the entire length.

For basic type $\phi 25$ with 5 and 10 stroke, through-hole is threaded over the entire length.

Note) With auto switch (Built-in magnet): $\phi 20$; 5 stroke

* For details about the rod end nut and accessory brackets, refer to page 796.

- CUJ
- CU
- CQS**
- JCQ
- CQ2
- RQ
- CQM
- CQU
- MU

- D-□
- X□

Technical Data

CQSK Series

Dimensions: $\varnothing 12$ to $\varnothing 25$

Foot type: CQSKL/CDQSKL

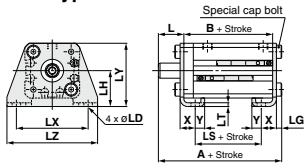

Foot Type

Bore size (mm)	Stroke range (mm)	Without auto switch			With auto switch			L	L ₁	LD	LG	LH	LT	LX	LY	LZ	X	Y
		A	B	LS	A	B	LS											
12	5 to 30	40.3	22	10	45.3	27	15	13.5	24	4.5	2.8	17	2	34	29.5	44	8	4.5
16	5 to 30	40.3	22	10	45.3	27	15	13.5	25.5	4.5	2.8	19	2	38	33.5	48	8	5
20	5 to 50	46.2	24.5	12.5	56.2	34.5	22.5	14.5	28.5	6.6	4	24	3.2	48	42	62	9.2	5.8
25	5 to 50	49.7	27.5	12.5	59.7	37.5	22.5	15	32.5	6.6	4	26	3.2	52	46	66	10.7	5.8

Foot bracket material: Carbon steel
Surface treatment: Nickel plated

Rod end male thread

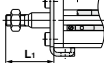

Compact foot type: CQSKLC/CDQSKLC

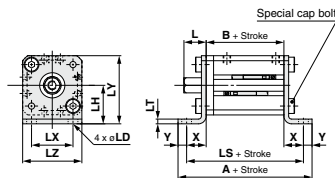

Compact Foot Type

Bore size (mm)	Stroke range (mm)	Without auto switch			With auto switch			L	L ₁	LD	LH	LT	LX	LY	LZ	X	Y
		A	B	LS	A	B	LS										
12	5 to 30	49.6	22	40.6	54.6	27	45.6	13.5	24	4.5	17	2	15.5	29.5	25	9.3	4.5
16	5 to 30	50.6	22	40.6	55.6	27	45.6	13.5	25.5	4.5	19	2	20	33.5	29	9.3	5
20	5 to 50	62.5	24.5	50.9	72.5	34.5	60.9	14.5	28.5	6.6	24	3.2	25.5	42	36	13.2	5.8
25	5 to 50	65.5	27.5	53.9	75.5	37.5	63.9	15	32.5	6.6	26	3.2	28	46	40	13.2	5.8

Compact foot bracket material: Carbon steel
Surface treatment: Zinc chromated

Rod end male thread



Rod side flange type: CQSKF/CDQSKF

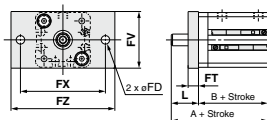

Rod Side Flange Type

Bore size (mm)	Stroke range (mm)	Without auto switch		With auto switch		FD	FT	FV	FX	FZ	L	L ₁
		A	B	A	B							
12	5 to 30	35.5	22	40.5	27	4.5	5.5	25	45	55	13.5	24
16	5 to 30	35.5	22	40.5	27	4.5	5.5	30	45	55	13.5	25.5
20	5 to 50	39	24.5	49	34.5	6.6	8	39	48	60	14.5	28.5
25	5 to 50	42.5	27.5	52.5	37.5	6.6	8	42	52	64	15	32.5

Flange bracket material: Carbon steel
Surface treatment: Nickel plated

Rod end male thread

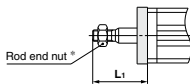

Head side flange type: CQSKG/CDQSKG

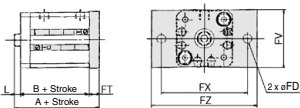

Head Side Flange Type

Bore size (mm)	Stroke range (mm)	Without auto switch		With auto switch		FD	FT	FV	FX	FZ	L	L ₁
		A	B	A	B							
12	5 to 30	31	22	36	27	4.5	5.5	25	45	55	3.5	14
16	5 to 30	31	22	36	27	4.5	5.5	30	45	55	3.5	15.5
20	5 to 50	37	24.5	47	34.5	6.6	8	39	48	60	4.5	18.5
25	5 to 50	40.5	27.5	50.5	37.5	6.6	8	42	52	64	5	22.5

Flange bracket material: Carbon steel
Surface treatment: Nickel plated

Rod end male thread

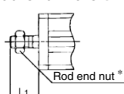

* For details about the rod end nut and accessory brackets, refer to page 796.

Compact Cylinder: Non-rotating Rod Type Double Acting, Double Rod

CQSKW Series

∅12, ∅16, ∅20, ∅25

How to Order

CQSKW **B** **20** - **30** **D** **□** - **□**

With auto switch **CDQSKW** **B** **20** - **30** **D** **□** - **M9BW** **□** - **□**

With auto switch
(Built-in magnet)

Mounting type

B	Through-hole/Both ends tapped common (Standard)
L	Foot type
LC	Compact foot type
F	Flange type

* Mounting brackets are shipped together (but not assembled).
* Cylinder mounting bolts are not included. Order them separately referring to "Mounting Bolt for CQSKW" on page 736.

Bore size

12	12 mm
16	16 mm
20	20 mm
25	25 mm

Cylinder stroke (mm)

Standard Stroke

Bore size (mm)	Standard stroke (mm)
12, 16	5, 10, 15, 20, 25, 30
20, 25	5, 10, 15, 20, 25, 30, 35, 40, 45, 50

Number of auto switches

Nil	2 pcs.
S	1 pc.
n	"n" pcs.

Auto switch

Nil	Without auto switch
------------	---------------------

* Refer to the table below for the applicable auto switch model.

Body option

Nil	Standard (Rod end female thread)
M	Rod end male thread

Action

D	Double acting
----------	---------------

Built-in Magnet Cylinder Model

If a built-in magnet cylinder without an auto switch is required, there is no need to enter the symbol for the auto switch.
(Example) CDQSKWL25-30D

Made to Order
Refer to page 733 for details.

Applicable Auto Switches/Refer to pages 1575 to 1701 for further information on auto switches.

Type	Special function	Electrical entry	Indicator light	Wiring (Output)	Load voltage		Auto switch model		Lead wire length (m)				Pre-wired connector	Applicable load	
					DC	AC	Perpendicular	In-line	0.5 (Nil)	1 (M)	3 (L)	5 (Z)			
Solid state auto switch	—	Grommet	Yes	3-wire (NPN)	24 V	5 V, 12 V	—	M9NV	M9N	●	●	●	○	IC circuit	Relay, PLC
				2-wire				M9PV	M9P	●	●	○	○		
				3-wire (PNP)	M9BV	M9B	●	●	○	○					
	3-wire (NPN)			M9NVV	M9NV	●	●	○	○						
	3-wire (PNP)			M9PWW	M9PW	●	●	○	○						
	2-wire			M9BWW	M9BW	●	○	○	○						
	Water resistant (2-color indicator)	Grommet	Yes	3-wire (NPN)	24 V	5 V, 12 V	—	M9NAV ^{*1}	M9NA ^{*1}	○	○	●	○	IC circuit	Relay, PLC
				3-wire (PNP)				M9PAV ^{*1}	M9PA ^{*1}	○	○	●	○		
				2-wire	M9BAV ^{*1}	M9BA ^{*1}	○	○	○	○					
Reed auto switch	—	Grommet	Yes	3-wire (NPN equivalent)	24 V	12 V	100 V 100 V or less	A96V	A96	●	—	●	—	IC circuit	Relay, PLC
				2-wire				A93V ^{*2}	A93	●	●	●	—		
Reed auto switch	—	Grommet	No	2-wire	24 V	12 V	100 V 100 V or less	A90V	A90	●	—	●	—	IC circuit	Relay, PLC
				2-wire				A90V	A90	●	—	●	—		

*1 Water resistant type auto switches can be mounted on the above models, but in such case SMC cannot guarantee water resistance.

Consult with SMC regarding water resistant types with the above model numbers.

*2 1 m type lead wire is only applicable to D-A93.

* Lead wire length symbols: 0.5 m..... Nil (Example) M9NV
1 m..... M (Example) M9NVV
3 m..... L (Example) M9NVLL
5 m..... Z (Example) M9NVZZ

* Solid state auto switches marked with "○" are produced upon receipt of order.

* Since there are other applicable auto switches than listed, refer to page 749 for details.

* For details about auto switches with pre-wired connector, refer to pages 1648 and 1649.

* Auto switches are shipped together (not assembled).

Note) There is the case D-A93□V/M9□V/M9□WV/M9□AV type auto switches cannot be mounted on the port surface, depending on the cylinder's stroke and the fitting size for piping. Consult with SMC for details.



Symbol

Without cushion

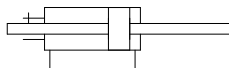

Made to Order:
Individual Specifications
(For details, refer to page 751)

Symbol	Specifications
-X633	Intermediate stroke of double rod cylinder

Made to Order Specifications

[Click here for details](#)

Symbol	Specifications
-XA□	Change of rod end shape
-XC6	Piston rod, retaining ring, rod end nut made of stainless steel

Body Option

Description	Application
Rod end male thread	Available for all non-rotating rod type.

Mounting Bracket Part No.

Bore size (mm)	Foot ⁽¹⁾	Compact foot ⁽¹⁾	Flange
12	CQSK-L012	CQSK-LC012	CQSK-F012
16	CQSK-L016	CQSK-LC016	CQSK-F016
20	CQSK-L020	CQSK-LC020	CQSK-F020
25	CQSK-L025	CQSK-LC025	CQSK-F025

Note 1) When ordering foot and compact foot brackets, order 2 pieces per cylinder.

Note 2) Parts belonging to each bracket are as follows.
Foot, Compact foot, Flange type: Body mounting bolt

Moisture Control Tube
IDK Series



When operating an actuator with a small diameter and a short stroke at a high frequency, the dew condensation (water droplet) may occur inside the piping depending on the conditions.

Simply connecting the moisture control tube to the actuator will prevent dew condensation from occurring. For details, refer to [the IDK series in the Best Pneumatics No. 6.](#)

Specifications

Bore size (mm)	12	16	20	25
Action	Double acting, Single rod			
Fluid	Air			
Lubrication	Not required (Non-lube)			
Proof pressure	1.5 MPa			
Maximum operating pressure	1.0 MPa			
Minimum operating pressure	0.07 MPa		0.05 MPa	
Ambient and fluid temperature	Without auto switch: -10 to 70°C (No freezing)			
	With auto switch: -10 to 60°C (No freezing)			
Cushion	None			
Rod end thread	Female thread			
Stroke length tolerance	$\begin{matrix} +1.0 \text{ mm} \\ 0 \end{matrix}$			
Piston speed	50 to 500 mm/s			
Allowable kinetic energy (J)	0.022	0.038	0.055	0.09
Rod non-rotating accuracy	$\pm 1^\circ$		$\pm 0.7^\circ$	

Theoretical Output

(N)

Bore size (mm)	Rod width across flats (mm)	Piston area (mm ²)	Operating pressure (MPa)		
			0.3	0.5	0.7
12	5.2	90	27	45	63
16	6.2	168	50	84	117
20	8.2	256	77	128	179
25	10.2	401	120	200	281

Manufacture of Intermediate Stroke

Description	Spacer is installed in the standard stroke body.	
Part no.	Suffix "-X633" to the end of standard model no. (page 706).	
Description	Intermediate strokes in 1 mm increments are available by using spacers with standard stroke cylinders.	
Stroke range	Bore size	
	12, 16	Stroke range
	20, 25	6 to 29
Example	Part no.: CQSKW25-47D-X633	
	CQSKWB25-50D with 3 mm width spacer inside. B dimension is 84 mm.	

Refer to pages 747 to 749 for cylinders with auto switches.

- Minimum auto switch mounting stroke
- Proper auto switch mounting position (detection at stroke end) and mounting height
- Operating range

CUJ

CU

CQS

JCQ

CQ2

RQ

CQM

CQU

MU

D-□

-X□

Technical Data

Construction

Basic type

ø12

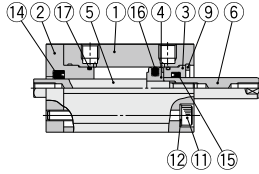

ø16, ø20, ø25

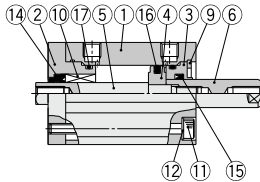

Rod end male thread

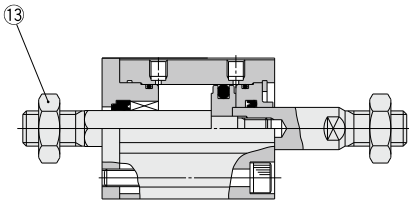

With auto switch (Built-in magnet)

ø12

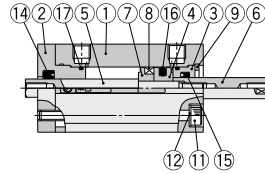

ø16

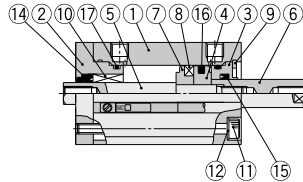

ø20, ø25

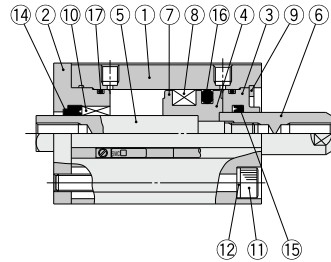

Component Parts

No.	Description	Material	Note
1	Cylinder tube	Aluminum alloy	Hard anodized
2	Rod cover	Aluminum alloy	Anodized
3	Collar	Aluminum alloy	Anodized
4	Piston	Aluminum alloy	
5	Piston rod A	Stainless steel	
6	Piston rod B	Stainless steel	
7	Spacer for switch type	Aluminum alloy	Chromated
8	Magnet	—	
9	Retaining ring	Carbon tool steel	Phosphate coated
10	Non-rotating guide	Oil impregnated sintered alloy	ø16, ø20 and ø25
11	Hexagon socket head cap screw	Alloy steel	Nickel plated
12	Plain washer	Rolled steel	Nickel plated
13	Rod end nut	Carbon steel	Zinc chromated
14*	Rod seal for non-rotating	NBR	
15*	Rod seal	NBR	
16*	Piston seal	NBR	
17*	Tube gasket	NBR	

Replacement Parts/Seal Kit

Bore size (mm)	Kit no.	Contents
12	CQSKWB12-PS	Set of nos. above 14, 15, 16, 17.
16	CQSKWB16-PS	
20	CQSKWB20-PS	
25	CQSKWB25-PS	

* Seal kit includes 14, 15, 16, 17. Order the seal kit, based on each bore size.

* Since the seal kit does not include a grease pack, order it separately.

Grease pack part no.: GR-S-010 (10 g)

CJ

CU

CQS

JCQ

CQ2

RQ

CQM

CQU

MU

D-□

-X□

Technical Data

CQSKW Series

Mounting Bolt for CQSKW

Mounting method: Mounting bolt for through-hole mounting type of CQSKW is available as an option.

Refer to the following for ordering procedures.
Order the actual number of bolts that will be used.

Example) CQ-M3x30L 2 pcs.

Round rod side mounting

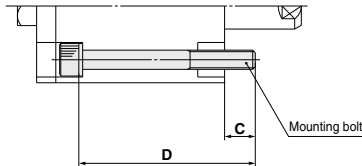

Non-rotating rod side mounting

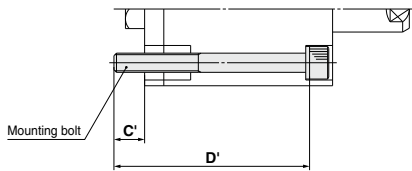

Note) When mounting a cylinder with through-hole, be sure to use the attached plain washer.

Cylinder model	C	D	Mounting bolt part no.	C'	D'	Mounting bolt part no.
CQSKWB12-5D		25	CQ-M3 x 30L		30	CQ-M3 x 35L
-10D	6.5	30	x 35L	6.5	35	x 40L
-15D		35	x 40L		40	x 45L
-20D		40	x 45L		45	x 50L
-25D		45	x 50L		50	x 55L
-30D		50	x 55L		55	x 60L
CQSKWB16-5D		25	CQ-M3 x 30L		30	CQ-M3 x 35L
-10D	6.5	30	x 35L	6.5	35	x 40L
-15D		35	x 40L		40	x 45L
-20D		40	x 45L		45	x 50L
-25D		45	x 50L		50	x 55L
-30D		50	x 55L		55	x 60L
CQSKWB20-5D		25	CQ-M5 x 35L		30	CQ-M5 x 40L
-10D	6.5	30	x 40L	6.5	35	x 45L
-15D		35	x 45L		40	x 50L
-20D		40	x 50L		45	x 55L
-25D		45	x 55L		50	x 60L
-30D		50	x 60L		55	x 65L
CQSKWB25-5D		25	CQ-M5 x 35L		30	CQ-M5 x 40L
-10D	10	30	x 40L	10	35	x 45L
-15D		35	x 45L		40	x 50L
-20D		40	x 50L		45	x 55L
-25D		45	x 55L		50	x 60L
-30D		50	x 60L		55	x 65L
-35D		55	x 65L		60	x 70L
-40D		60	x 70L		65	x 75L
-45D		65	x 75L		70	x 80L
-50D		70	x 80L		75	x 85L
CQSKWB25-5D		30	CQ-M5 x 40L		35	CQ-M5 x 45L
-10D	7	35	x 45L	7	40	x 50L
-15D		40	x 45L		45	x 50L
-20D		45	x 50L		50	x 55L
-25D		50	x 55L		55	x 60L
-30D		55	x 60L		60	x 65L
-35D		60	x 65L		65	x 70L
-40D		65	x 70L		70	x 75L
-45D		70	x 75L		75	x 80L
-50D		75	x 80L		80	x 85L

Material: Chromium molybdenum steel
Surface treatment: Zinc chromated

Mounting Bolt for CDQSKW

Mounting method: Mounting bolt for through-hole mounting type of CDQSKW is available as an option.

Refer to the following for ordering procedures.
Order the actual number of bolts that will be used.

Example) CQ-M3x35L 2 pcs.

Round rod side mounting

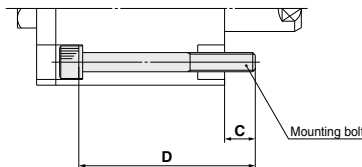

Non-rotating rod side mounting

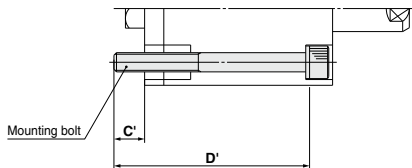

Note) When mounting a cylinder with through-hole, be sure to use the attached plain washer.

Cylinder model	C	D	Mounting bolt part no.	C'	D'	Mounting bolt part no.
CDQSKWB12-5D		30	CQ-M3 x 35L		35	CQ-M3 x 40L
-10D	6.5	35	x 40L	6.5	40	x 45L
-15D		40	x 45L		45	x 50L
-20D		45	x 50L		50	x 55L
-25D		50	x 55L		55	x 60L
-30D		55	x 60L		60	x 65L
CDQSKWB16-5D		30	CQ-M3 x 35L		35	CQ-M3 x 40L
-10D	6.5	35	x 40L	6.5	40	x 45L
-15D		40	x 45L		45	x 50L
-20D		45	x 50L		50	x 55L
-25D		50	x 55L		55	x 60L
-30D		55	x 60L		60	x 65L
CDQSKWB20-5D		35	CQ-M5 x 45L		40	x 50L
-10D	10	40	x 50L	10	45	x 55L
-15D		45	x 55L		50	x 60L
-20D		50	x 60L		55	x 65L
-25D		55	x 65L		60	x 70L
-30D		60	x 70L		65	x 75L
-35D		65	x 75L		70	x 80L
-40D		70	x 80L		75	x 85L
-45D		75	x 85L		80	x 90L
-50D		80	x 90L		85	x 95L
CDQSKWB25-5D		40	CQ-M5 x 45L		45	CQ-M5 x 50L
-10D	7	45	x 50L	7	50	x 55L
-15D		50	x 55L		55	x 60L
-20D		55	x 60L		60	x 65L
-25D		60	x 65L		65	x 70L
-30D		65	x 70L		70	x 75L
-35D		70	x 75L		75	x 80L
-40D		75	x 80L		80	x 85L
-45D		80	x 85L		85	x 90L
-50D		85	x 90L		90	x 95L

Material: Chromium molybdenum steel
Surface treatment: Zinc chromated

Dimensions: $\phi 12$ to $\phi 25$

Basic type (Through-hole/Both ends tapped common): CQSKW/CDQSKW

* For the auto switch mounting position and its mounting height, refer to page 748.

$\phi 12$

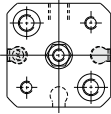

$\phi 16$

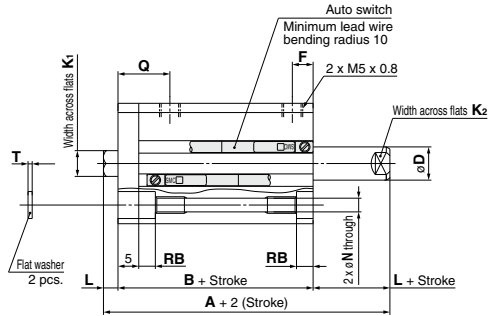
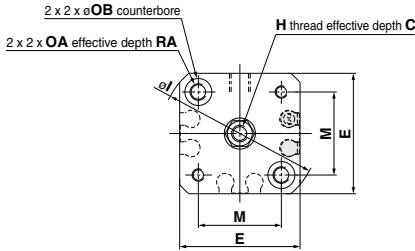

$\phi 20, \phi 25$

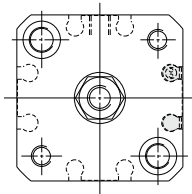

Rod end male thread

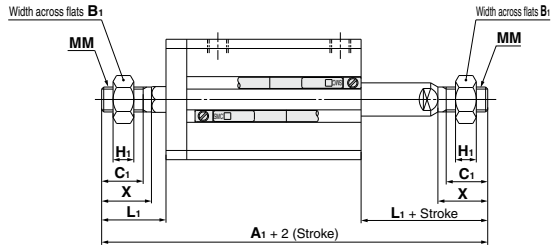

Rod End Male Thread

Bore size (mm)	Without auto switch		With auto switch		B ₁	C ₁	H ₁	L ₁	MM	X
	A ₁	A ₁	A ₁	A ₁						
12	55	60	8	9	4	14	M5 x 0.8	10.5		
16	58	63	10	10	5	15.5	M6 x 1.0	12		
20	68	78	13	12	5	18.5	M8 x 1.25	14		
25	79	89	17	15	6	22.5	M10 x 1.25	17.5		

Basic Type

Bore size (mm)	Stroke range (mm)	Without auto switch				With auto switch				C	D	E	F	H	I	K ₁	K ₂	L	M	N	OA	OB	Q	RA	RB	T		
		A	B	A	B	A	B	A	B																			
12	5 to 30	34	27	39	32	6	6	25	7.5	M3 x 0.5	32	5.2	5	3.5	15.5	3.5	M4 x 0.7	6.5	12.5	7	4	0.5						
16	5 to 30	34	27	39	32	8	8	29	7.5	M4 x 0.7	38	6.2	6	3.5	20	3.5	M4 x 0.7	6.5	12.5	7	4	0.5						
20	5 to 50	40	31	50	41	7	10	36	8	M5 x 0.8	47	8.2	8	4.5	25.5	5.4	M6 x 1.0	9	13	10	7	1						
25	5 to 50	44	34	54	44	12	12	40	9	M6 x 1.0	52	10.2	10	5	28	5.4	M6 x 1.0	9	14	10	7	1						

Note 1) For basic type $\phi 20$ and $\phi 25$ with 5 stroke, through-hole is threaded over the entire length.

Note 2) The positions of width across flats (K₂) on both sides are not the same.

* For details about the rod end nut and accessory brackets, refer to page 796.

- CUJ
- CU
- CQS
- JCQ
- CQ2
- RQ
- CQM
- CQU
- MU

- D-
- X
- Technical Data

CQSKW Series

Dimensions: $\varnothing 12$ to $\varnothing 25$

Foot type: CQSKWL/CDQSKWL

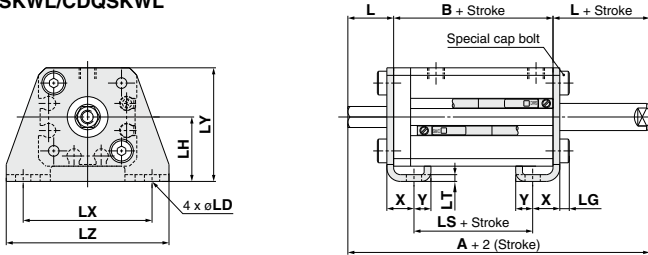

Rod end male thread

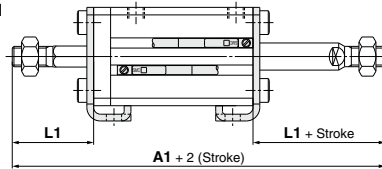

Foot Type

Bore size (mm)	Stroke range (mm)	Without auto switch				With auto switch				L	L1	LD	LG	LH	LT	LX	LY	LZ	X	Y
		A	A1	B	LS	A	A1	B	LS											
12	5 to 30	54	75	27	15	59	80	32	20	13.5	24	4.5	2.8	17	2	34	29.5	44	8	4.5
16	5 to 30	54	78	27	15	59	83	32	20	13.5	25.5	4.5	2.8	19	2	38	33.5	48	8	5
20	5 to 50	60	88	31	19	70	98	41	29	14.5	28.5	6.6	4	24	3.2	48	42	62	9.2	5.8
25	5 to 50	64	99	34	19	74	109	44	29	15	32.5	6.6	4	26	3.2	52	46	66	10.7	5.8

Foot bracket material: Carbon steel
Surface treatment: Nickel plated

Compact foot type CQSKWLC/CDQSKWLC

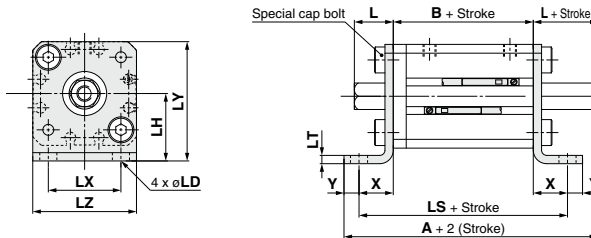

Rod end male thread

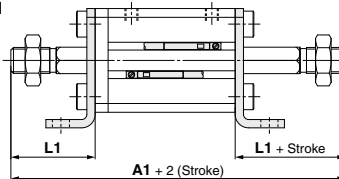

Compact Foot Type

Bore size (mm)	Stroke range (mm)	Without auto switch				With auto switch				L	L1	LD	LH	LT	LX	LY	LZ	X	Y
		A	A1	B	LS	A	A1	B	LS										
12	5 to 30	54.3	75	27	45.6	59.3	80	32	50.6	13.5	24	4.5	17	2	15.5	29.5	25	9.3	4.5
16	5 to 30	54.8	78	27	45.6	59.8	83	32	50.6	13.5	25.5	4.5	19	2	20	33.5	29	9.3	5
20	5 to 50	64.5	88	31	57.4	74.5	98	41	67.4	14.5	28.5	6.6	24	3.2	25.5	42	36	13.2	5.8
25	5 to 50	68	99	34	60.4	78	109	44	70.4	15	32.5	6.6	26	3.2	28	46	40	13.2	5.8

* For details about the rod end nut and accessory brackets, refer to page 796.

Compact foot bracket material: Carbon steel
Surface treatment: Zinc chromated

Dimensions: $\varnothing 12$ to $\varnothing 25$

Flange type: CQSKWF/CDQSKWF

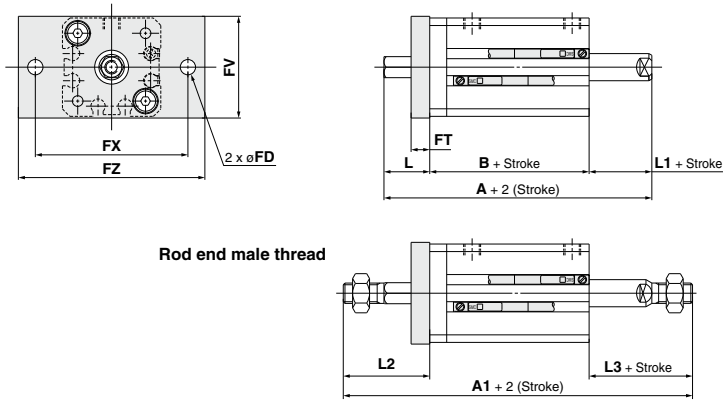

Flange Type

Bore size (mm)	Stroke range (mm)	Without auto switch			With auto switch			FD	FT	FV	FX	FZ	L	L1	L2	L3
		A	A1	B	A	A1	B									
12	5 to 30	44	65	27	49	70	32	4.5	5.5	25	45	55	13.5	3.5	24	14
16	5 to 30	44	68	27	49	73	32	4.5	5.5	30	45	55	13.5	3.5	25.5	15.5
20	5 to 50	50	78	31	60	88	41	6.6	8	39	48	60	14.5	4.5	28.5	18.5
25	5 to 50	54	89	34	64	99	44	6.6	8	42	52	64	15	5	32.5	22.5

* For details about the rod end nut and accessory brackets, refer to page 796.

Note 1) The positions of piston rod width across flats (right side) are not constant.

Flange bracket material: Carbon steel
Surface treatment: Nickel plated

CUJ

CU

CQS

JCQ

CQ2

RQ

CQM

CQU

MU

D-□

-X□

Technical Data



Symbol
Rubber bumper

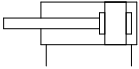

Made to Order: Individual Specifications
(For details, refer to pages 750 and 752.)

Symbol	Specifications
-X271	Fluororubber seals
-X1876	With concave shape end boss on the cylinder tube head side

Made to Order Specifications

[Click here for details](#)

Symbol	Specifications
-XA□	Change of Rod End Shape
-XB10	Intermediate stroke (Using exclusive body)
-XC6	Piston rod, retaining ring, rod end nut made of stainless steel
-XC85	Grease for food processing equipment

Body Option

Description	Application
Rod end male thread	Available for Double acting, Single rod models.

Mounting Bracket Part No.

Bore size (mm)	Foot (1)	Compact foot (1)	Flange	Double clevis
12	CQS-L012	CQS-LC012	CQS-F012	CQS-D012
16	CQS-L016	CQS-LC016	CQS-F016	CQS-D016
20	CQS-L020	CQS-LC020	CQS-F020	CQS-D020
25	CQS-L025	CQS-LC025	CQS-F025	CQS-D025

Note1) When ordering foot and compact foot brackets, order 2 pieces per cylinder.

Note2) Parts belonging to each bracket are as follows.
Foot, Compact foot, Flange type: Body mounting bolt
Double clevis type: Clevis pin, type C retaining ring
for axis, Body mounting bolt

Moisture Control Tube IDK Series



When operating an actuator with a small diameter and a short stroke at a high frequency, the dew condensation (water droplet) may occur inside the piping depending on the conditions.

Simply connecting the moisture control tube to the actuator will prevent dew condensation from occurring. For details, refer to [the IDK series in the Best Pneumatics No. 6.](#)

Standard Specifications

Bore size (mm)	12	16	20	25
Action	Double acting, Single rod			
Fluid	Air			
Lubrication	Not required (Non-lube)			
Proof pressure	1.5 MPa			
Maximum operating pressure	1.0 MPa			
Minimum operating pressure	0.07 MPa		0.05 MPa	
Ambient and fluid temperature	Without auto switch: -10 to 70°C (No freezing)			
	With auto switch: -10 to 60°C (No freezing)			
Cushion	Rubber bumper*			
Rod end thread	Female thread			
Stroke length tolerance	+1.0 mm ± 0			
Piston speed	50 to 500 mm/s			
Allowable kinetic energy (J)	0.043	0.075	0.11	0.18

*Stroke length tolerance does not include the deflection of the bumper.

Theoretical Output

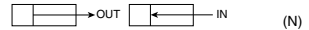

Bore size (mm)	Rod size (mm)	Operating direction	Piston area (mm ²)	Operating pressure (MPa)		
				0.3	0.5	0.7
12	6	IN	84.8	25	42	59
		OUT	113	34	57	79
16	8	IN	151	45	75	106
		OUT	201	60	101	141
20	10	IN	236	71	118	165
		OUT	314	94	157	220
25	12	IN	378	113	189	264
		OUT	491	147	245	344

Manufacture of Intermediate Stroke

Description	Spacer is installed in the standard stroke body.	
Part no.	Refer to "How to Order" for the standard model no. (page 740).	
Standard stroke	Description	Intermediate strokes in 1 mm increments are available by using spacers with standard stroke cylinders.
	Stroke range	Bore size
		Stroke range
Example	Part no.: CQSBS25-47D CQSBS25-50D with 3 mm width spacer inside. B dimension is 77.5 mm.	

Refer to pages 747 to 749 for cylinders with auto switches.

- Minimum auto switch mounting stroke
- Proper auto switch mounting position (detection at stroke end) and mounting height
- Operating range

CUJ

CU

CQS

JCQ

CQ2

RQ

CQM

CQU

MU

D-□

-X□

Technical Data

Weight/Without Auto Switch (g)

Bore size (mm)	Cylinder stroke (mm)									
	5	10	15	20	25	30	35	40	45	50
12	37	43	50	57	63	70	-	-	-	-
16	49	57	66	74	83	92	-	-	-	-
20	75	88	101	114	127	140	153	165	178	191
25	109	125	140	156	172	188	204	220	236	252

For standard strokes

Calculation: (Example) CQSDS20-20DCM

- Cylinder weight: CQBS20-20DC 114 g
- Additional weight: Rod end male thread 10 g
- : Double clevis type 92 g
- 216 g

Weight/With Auto Switch (Built-in magnet) (g)

Bore size (mm)	Cylinder stroke (mm)									
	5	10	15	20	25	30	35	40	45	50
12	45	51	58	65	71	78	-	-	-	-
16	59	67	76	85	94	103	-	-	-	-
20	106	119	132	145	157	170	183	195	208	221
25	151	167	183	199	215	231	246	262	278	294

Additional Weight (g)

Bore size (mm)		12	16	20	25
Rod end male thread	Male thread	1.5	3	6	12
	Nut	1	2	4	8
With boss on head end		0.7	1.3	2	3
Foot type (Including mounting bolt)		55	65	159	181
Compact foot type (Including mounting bolt)		41	51	121	140
Rod side flange type (Including mounting bolt)		58	70	143	180
Head side flange type (Including mounting bolt)		56	66	137	171
Double clevis type (Including pin, retaining ring, bolt)		34	40	92	127

Mounting Bolt for CQSBS

Mounting method: Mounting bolt for through-hole mounting type of CQSBS is available as an option.

Refer to the following for ordering procedures. Order the actual number of bolts that will be used.

Example) CQ-M3x30L 4 pcs.

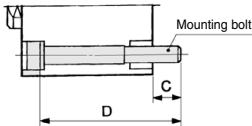

Note) When mounting a cylinder with through-hole, be sure to use the attached plain washer.

Cylinder model	C	D	Mounting bolt part no.
CQSBS12-5DC	6.5	30	CQ-M3 x 30L
		35	x 35L
		40	x 40L
		45	x 45L
		50	x 50L
		55	x 55L
CQSBS16-5DC	6.5	30	CQ-M3 x 30L
		35	x 35L
		40	x 40L
		45	x 45L
		50	x 50L
		55	x 55L
CQSBS20-5DC	6.5	30	CQ-M5 x 30L
		35	x 35L
		40	x 40L
		45	x 45L
		50	x 50L
		55	x 55L

Cylinder model	C	D	Mounting bolt part no.
CQSBS20-25DC	6.5	50	CQ-M5 x 50L
		55	x 55L
		60	x 60L
		65	x 65L
		70	x 70L
		75	x 75L
CQSBS25-5DC	8.5	35	CQ-M5 x 35L
		40	x 40L
		45	x 45L
		50	x 50L
		55	x 55L
		60	x 60L
	8.5	65	x 65L
		70	x 70L
		75	x 75L
		80	x 80L
		85	x 85L
		90	x 90L

Material: Chromium molybdenum steel
Surface treatment: Zinc chromated

Mounting Bolt for CDQSBS with Auto Switch

Mounting method: Mounting bolt for through-hole mounting type of CDQSBS is available as an option.

Refer to the following for ordering procedures. Order the actual number of bolts that will be used.

Example) CQ-M3x35L 4 pcs.

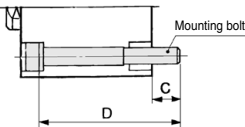

Note) When mounting a cylinder with through-hole, be sure to use the attached plain washer.

Cylinder model	C	D	Mounting bolt part no.
CDQSBS12-5DC	6.5	35	CQ-M3 x 35L
		40	x 40L
		45	x 45L
		50	x 50L
		55	x 55L
		60	x 60L
CDQSBS16-5DC	6.5	35	CQ-M3 x 35L
		40	x 40L
		45	x 45L
		50	x 50L
		55	x 55L
		60	x 60L
CDQSBS20-5DC	6.5	40	CQ-M5 x 40L
		45	x 45L
		50	x 50L
		55	x 55L
		60	x 60L
		65	x 65L

Cylinder model	C	D	Mounting bolt part no.
CDQSBS20-25DC	6.5	60	CQ-M5 x 60L
		65	x 65L
		70	x 70L
		75	x 75L
		80	x 80L
		85	x 85L
CDQSBS25-5DC	8.5	45	CQ-M5 x 45L
		50	x 50L
		55	x 55L
		60	x 60L
		65	x 65L
		70	x 70L
	8.5	75	x 75L
		80	x 80L
		85	x 85L
		90	x 90L

Material: Chromium molybdenum steel
Surface treatment: Zinc chromated

Construction

Basic type

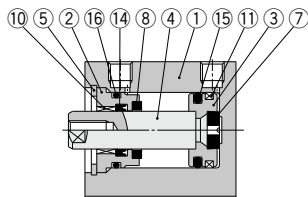

Rod end male thread

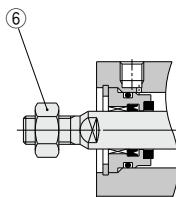

With auto switch (Built-in magnet)

ø12, ø16

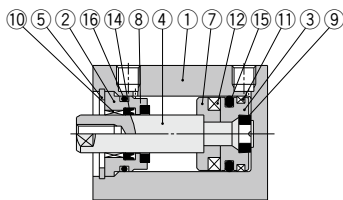

ø20, ø25

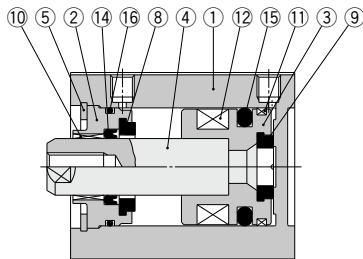

Component Parts

No.	Description	Material	Note
1	Cylinder tube	Aluminum alloy	Hard anodized
2	Collar	Aluminum alloy	Anodized
3	Piston	Aluminum alloy	
4	Piston rod	Stainless steel	
5	Retaining ring	Carbon tool steel	Phosphate coated
6	Rod end nut	Carbon steel	Zinc chromated
7	Spacer for switch type	Aluminum alloy	Chromated
8	Bumper A	Urethane	
9	Bumper B	Urethane	
10	Bushing	Oil-impregnated sintered alloy	
11	Wear ring	Resin	
12	Magnet	—	
13	Centering location ring	Aluminum alloy	Anodized
14*	Rod seal	NBR	
15*	Piston seal	NBR	
16*	Tube gasket	NBR	

Replacement Parts/Seal Kit

Bore size (mm)	Kit no.	Contents
12	CQSB12-PS	
16	CQSB16-PS	Set of nos. above 14, 15, 16.
20	CQSB20-PS	
25	CQSB25-PS	

* Seal kit includes 14, 15, 16. Order the seal kit, based on each bore size.

* Since the seal kit does not include a grease pack, order it separately.

Grease pack part no.: GR-S-010 (10 g)

With boss on head end

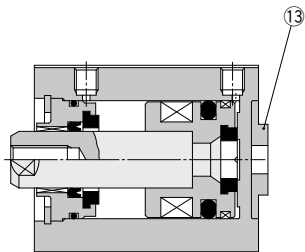

CJ

CU

CQS

JCQ

CQ2

RQ

CQM

CQU

MU

D-□

-X□

Technical
Data

Dimensions: $\phi 12$ to $\phi 25$

Basic type (Through-hole/Both ends tapped common): CQSBS/CDQSBS

$\phi 12$

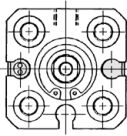

$\phi 16$

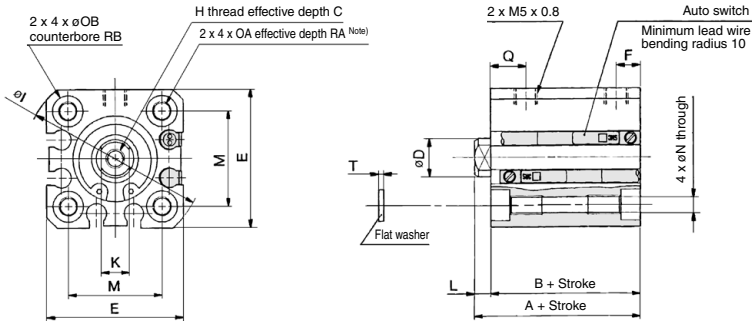

$\phi 20, \phi 25$

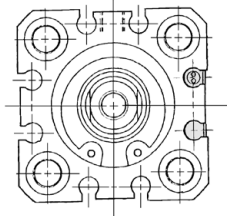

Rod end male thread

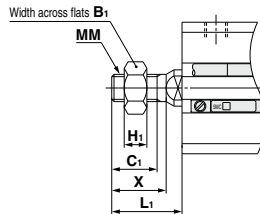

With boss on head end

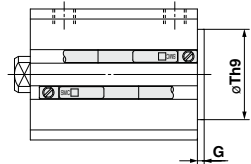

Rod End Male Thread

Bore size (mm)	B ₁	C ₁	H ₁	L ₁	MM	X
12	8	9	4	14	M5 x 0.8	10.5
16	10	10	5	15.5	M6 x 1.0	12
20	13	12	5	18.5	M8 x 1.25	14
25	17	15	6	22.5	M10 x 1.25	17.5

With Boss on Head End (mm)

Bore size (mm)	G	Th9
12	1.5	15 ⁰ _{0.043}
16	1.5	20 ⁰ _{0.052}
20	2	13 ⁰ _{0.043}
25	2	15 ⁰ _{0.043}

Note) With boss on rod end: Option (Suffix "-XC36" to the end of part number.)

Note that only bore sizes $\phi 12$ and $\phi 16$ are applicable to the long stroke.

Basic Type

Bore size (mm)	Stroke range (mm)	Without auto switch		With auto switch		C	D	E	F	H	I	K	L	M	N	OA	OB	Q	RA	RB	T
		A	B	A	B																
12	5 to 30	25.5	22	30.5	27	6	6	25	5	M3 x 0.5	32	5	3.5	15.5	3.5	M4 x 0.7	6.5	7.5	7	4	0.5
16	5 to 30	25.5	22	30.5	27	8	8	29	5	M4 x 0.7	38	6	3.5	20	3.5	M4 x 0.7	6.5	7.5	7	4	0.5
20	5 to 50	29	24.5	39	34.5	7	10	36	5.5	M5 x 0.8	47	8	4.5	25.5	5.4	M6 x 1.0	9	8	10	7	1
25	5 to 50	32.5	27.5	42.5	37.5	12	12	40	5.5	M6 x 1.0	52	10	5	28	5.4	M6 x 1.0	9	9	10	7	1

Note) For basic type 5 to 10 stroke with $\phi 20$ and 5 stroke with $\phi 25$, through-hole is threaded over the entire length.

* For details about the rod end nut and accessory brackets, refer to page 796.

Dimensions: $\varnothing 12$ to $\varnothing 25$

Foot type: CQSLC/CDQSLC

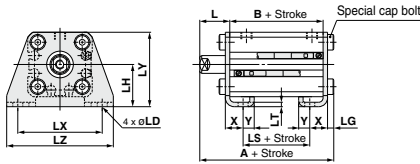

Rod end male thread

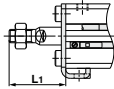

Compact foot type: CQSLCS/CDQSLCS

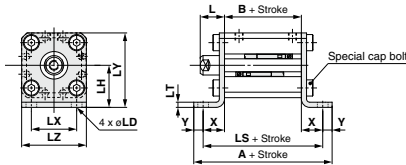

Rod end male thread

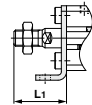

Rod side flange type: CQSFS/CDQSFS

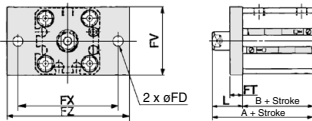

Rod end male thread

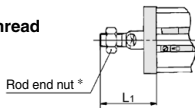

Head side flange type: CQSGS/CDQSGS

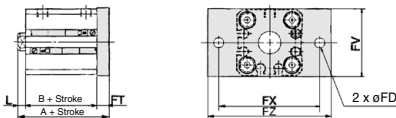

Rod end male thread

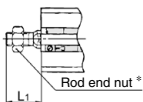

Foot Type

Bore size (mm)	Stroke range (mm)	Without auto switch			With auto switch		
		A	B	LS	A	B	LS
12	5 to 30	40.3	22	10	45.3	27	15
16	5 to 30	40.3	22	10	45.3	27	15
20	5 to 50	46.2	24.5	12.5	56.2	34.5	22.5
25	5 to 50	49.7	27.5	12.5	59.7	37.5	22.5

Bore size (mm)	L	L ₁	LD	LG	LH	LT	LX	LY	LZ	X	Y
12	13.5	24	4.5	2.8	17	2	34	29.5	44	8	4.5
16	13.5	25.5	4.5	2.8	19	2	38	33.5	48	8	5
20	14.5	28.5	6.6	4	24	3.2	48	42	62	9.2	5.8
25	15	32.5	6.6	4	26	3.2	52	46	66	10.7	5.8

Foot bracket material: Carbon steel
Surface treatment: Nickel plated

Compact Foot Type

Bore size (mm)	Stroke range (mm)	Without auto switch			With auto switch		
		A	B	LS	A	B	LS
12	5 to 30	49.6	22	40.6	54.6	27	45.6
16	5 to 30	50.6	22	40.6	55.6	27	45.6
20	5 to 50	62.5	24.5	50.9	72.5	34.5	60.9
25	5 to 50	65.5	27.5	53.9	75.5	37.5	63.9

Bore size (mm)	L	L ₁	LD	LH	LT	LX	LY	LZ	X	Y
12	13.5	24	4.5	17	2	15.5	29.5	25	9.3	4.5
16	13.5	25.5	4.5	19	2	20	33.5	29	9.3	5
20	14.5	28.5	6.6	24	3.2	25.5	42	36	13.2	5.8
25	15	32.5	6.6	26	3.2	28	46	40	13.2	5.8

Compact foot bracket material: Carbon steel
Surface treatment: Zinc chromated

Rod Side Flange Type

Bore size (mm)	Stroke range (mm)	Without auto switch		With auto switch	
		A	B	A	B
12	5 to 30	35.5	22	40.5	27
16	5 to 30	35.5	22	40.5	27
20	5 to 50	39	24.5	49	34.5
25	5 to 50	42.5	27.5	52.5	37.5

Bore size (mm)	FD	FT	FV	FX	FZ	L	L ₁
12	4.5	5.5	25	45	55	13.5	24
16	4.5	5.5	30	45	55	13.5	25.5
20	6.6	8	39	48	60	14.5	28.5
25	6.6	8	42	52	64	15	32.5

Flange bracket material: Carbon steel
Surface treatment: Nickel plated

Head Side Flange Type

Bore size (mm)	Stroke range (mm)	Without auto switch		With auto switch	
		A	B	A	B
12	5 to 30	31	22	36	27
16	5 to 30	31	22	36	27
20	5 to 50	37	24.5	47	34.5
25	5 to 50	40.5	27.5	50.5	37.5

Bore size (mm)	FD	FT	FV	FX	FZ	L	L ₁
12	4.5	5.5	25	45	55	3.5	14
16	4.5	5.5	30	45	55	3.5	15.5
20	6.6	8	39	48	60	4.5	18.5
25	6.6	8	42	52	64	5	22.5

Flange bracket material: Carbon steel
Surface treatment: Nickel plated

* For details about the rod end nut and accessory brackets, refer to page 796.

Dimensions: $\varnothing 12$ to $\varnothing 25$

Double clevis type: CQS \square SDS/CDQS \square SDS

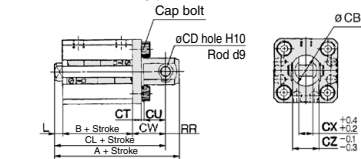

Rod end male thread

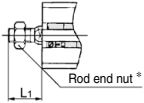

Double Clevis Type

Bore size (mm)	Stroke range (mm)	Without auto switch			With auto switch		
		A	B	CL	A	B	CL
12	5 to 30	45.5	22	39.5	50.5	27	44.5
16	5 to 30	46.5	22	40.5	51.5	27	45.5
20	5 to 50	56	24.5	47	66	34.5	57
25	5 to 50	62.5	27.5	52.5	72.5	37.5	62.5

Bore size (mm)	CB	CD	CT	CU	CW	CX	CZ	L	L ₁	RR
12	12	5	4	7	14	5	10	3.5	14	6
16	14	5	4	10	15	6.5	12	3.5	15.5	6
20	20	8	5	12	18	8	16	4.5	18.5	9
25	24	10	5	14	20	10	20	5	22.5	10

Double clevis bracket material: Carbon steel
Surface treatment: Nickel plated

* For details about the double clevis pivot bracket, refer to page 705.

* For details about the rod end nut and accessory brackets, refer to page 796.

CUJ

CU

CQS

JCQ

CQ2

RQ

CQM

CQU

MU

D-□

-X□

Technical
Data

Auto Switch Mounting

Proper Auto Switch Mounting Position (Detection at stroke end) and Its Mounting Height

Basic type, Single acting (Spring return/Spring extend), Long stroke type, Anti-lateral load type

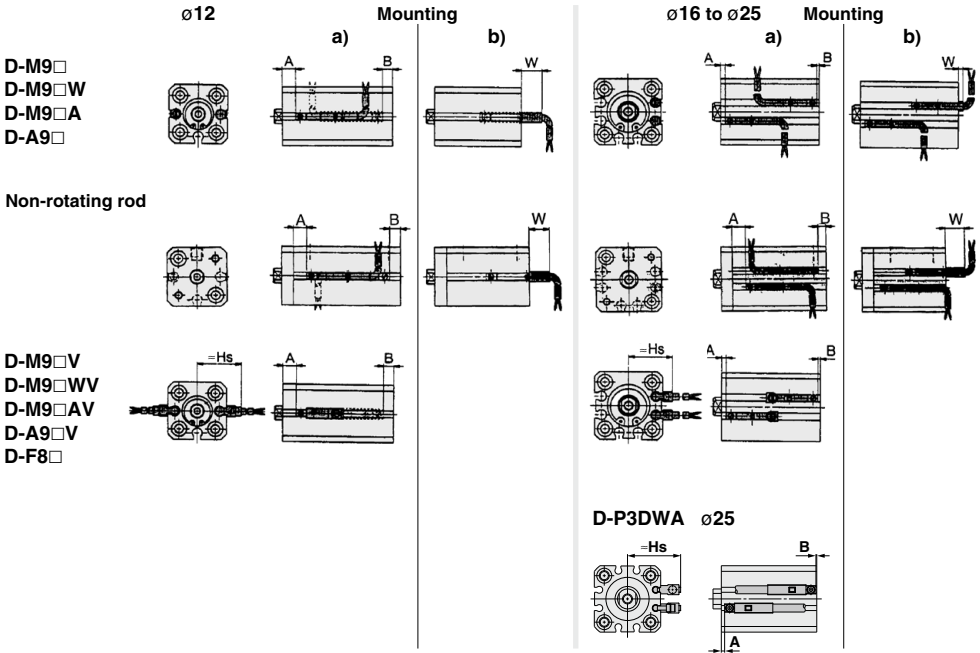

Proper Auto Switch Mounting Position (Detection at stroke end)

Proper Auto Switch Mounting Position

Auto switch model	D-M9□/M9□W			D-M9□V/M9□WV/M9□AV			D-M9□A			D-A9□			D-A9□V			D-F8□			D-P3DWA		
	A	B	W	A	B	Hs	A	B	W	A	B	W	A	B	Hs	A	B	Hs	A	B	Hs

Single rod: Basic type, Single acting (Spring return/Spring extend), Non-rotating rod []: Denotes the values of D-A93. (): Denotes the values of type T.

12	5.5 (6.5)	3.5 (4.5)	5.5 (6.5)	5.5 (6.5)	4.5 (3.5)	19.5	5.5 (6.5)	4.5 (3.5)	7.5 (8.5)	1.5 (2.5)	0	1.5 [4] (2.5 [5])	1.5 (2.5)	0	17	3.5	2.5	27	—	—	—
16	6	4	6	6	4	21.5	6	4	8	2	0	2 [4.5]	2	0	19	4	2	29	—	—	—
20	10	7.5	2.5	10	7.5	25	10	7.5	4.5	6	3.5	-1.5 [1]	6	3.5	22.5	8.5	5	32.5	—	—	—
25	11	9.5	0.5	11	9.5	27	11	9.5	2.5	7	5.5	-3.5 [-1]	7	5.5	24.5	9	7.5	34.5	6.5	5	33

Long stroke

12	9	11	-1	9	11	19.5	9	11	1	5	7	-5 [2.5]	5	7	17	7	9	27	—	—	—
16	9.5	10.5	-0.5	9.5	10.5	21.5	9.5	10.5	1.5	5.5	6	-4.5 [-2]	5.5	6	19	7.5	8.5	29	—	—	—
20	13	16	-6	13	16	25	13	16	-4	9	12	-10 [-7.5]	9	12	22.5	11	14	32.5	—	—	—
25	14	18	-8	14	18	27	14	18	-6	10	14	-12 [-9.5]	10	14	24.5	12	16	34.5	9.5	13.5	33

Anti-lateral load type

12	10	5	5	10	5	19.5	10	5	7	6	1	1 [3.5]	6	1	17	8	3	27	—	—	—
16	9.5	5.5	4.5	9.5	5.5	21.5	9.5	5.5	6.5	5.5	1.5	0.5 [3]	5.5	1.5	19	7.5	3.5	29	—	—	—
20	13	9.5	0.5	13	9.5	25	13	9.5	2.5	9	5.5	-3.5 [-1]	9	5.5	22.5	11	7.5	32.5	—	—	—
25	14	11.5	-1.5	14	11.5	27	14	11.5	0.5	10	7.5	-5.5 [-3]	10	7.5	24.5	12	9.5	34.5	9.5	7	33

Double acting: Basic type, Non-rotating rod

12	5.5	9.5	0.5	5.5	9.5	19.5	5.5	9.5	2.5	1.5	5.5	-3.5 [1]	1.5	5.5	17	3.5	7.5	27	—	—	—
16	6	9	1	6	9	21.5	6	9	3	2	5	-3 [-0.5]	2	5	19	4	7	29	—	—	—
20	10	14	-4	10	14	25	10	14	-2	6	10	-8 [-5.5]	6	10	22.5	8	12	32.5	—	—	—
25	11	16	-6	11	16	27	11	16	-4	7	12	-10 [-7.5]	7	12	24.5	9	14	34.5	6.5	11.5	33

Note 1) Negative figures in the table W indicate an auto switch is mounted inward from the edge of the cylinder body.

Note 2) The D-M9□/M9□W and M9□A cannot be installed on the single acting; single rod type.

Note 3) Adjust the auto switch after confirming the operating conditions in the actual setting.

Note 4) The D-P3DWA□ is available only for $\phi 25$.

Operating Range

Auto switch model	Bore size (mm)			
	12	16	20	25
D-M9□/M9□V D-M9□W/M9□WV D-M9□A/M9□AV	3	4	5.5	5.5
D-A9□/A9□V	6	7.5	10	10
D-F8□	2.5	3	4	4
D-P3DWA	—	—	—	6

* Since this is a guideline including hysteresis, not meant to be guaranteed. (assuming approximately ±30% dispersion.) There may be the case it will vary substantially depending on an ambient environment.

Minimum Auto Switch Mounting Stroke

No. of auto switch mounted	(mm)							
	D-M9□V	D-M9□WV D-M9□AV	D-A9□	D-A9□V	D-M9□	D-M9□W D-M9□A	D-F8□	D-P3DWA ^{Note 2)}
1 pc.	5	10	10 (5)	5	15 (5)	15 (10)	5	15
2 pcs.	5	10	10	10	15 (5)	15 (10)	5	15

Note 1) The D-M9□/M9□W/M9□A and P3DWA□ cannot be installed on the single acting: single rod type.
 Note 2) Available only for ø25.
 Note 3) As the dimension stated in () shows the minimum mountable stroke when the auto switch does not project from the end face of the cylinder body and the lead wire bending space is not hindered, the auto switch needs to be ordered separately. (Refer to the figure below.)

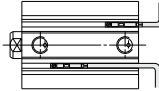

⚠️ Precautions

- Be sure to read this before handling the products.
- Refer to back page 50 for Safety Instructions and pages 3 to 12 for Actuator and Auto Switch Precautions.

• If the cylinder is used in an application in which a magnetic material is placed in close contact around the cylinder as shown in the graph on the right (including cases in which even one of the sides is in close contact) the operation of auto switches could become unstable. Therefore, please check with SMC for this type of application.

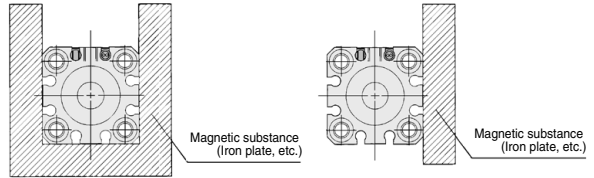

- Other than the applicable auto switches listed in "How to Order", the following auto switches can be mounted.
 - * Normally closed (NC = b contact), solid state auto switch (D-F9G/F9H type, and D-F8 type) are also available. For details, refer to pages 1592 and 1593.
 - * For solid state auto switches, auto switches with a pre-wired connector are also available. Refer to pages 1648 and 1649 for details.

CUJ

CU

CQS

JCQ

CQ2

RQ

CQM

CQU

MU

D-□

-X□

Technical Data



1 Special Piston Rod End for Double Rod Type Cylinder

Symbol
-X235

Male thread is used at one piston rod end of double rod type cylinder and female thread is used at the other end.

C□QSW **Mounting** **Bore size** — **Stroke** **D** — **X235**

* Specifications: Same as standard type.
Note) Please contact SMC for mounting bracket.

"D" in the case of "-235"

Piston rod end
Male thread, Female thread

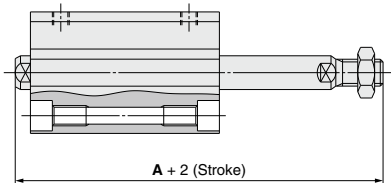

Symbol	Bore size	12	16	20	25
A		39.5 (44.5)	41 (46)	49 (59)	56.5 (66.5)
Applicable stroke		5 to 30		5 to 50	

Note 1) Applicable stroke is available in 5 mm increments.
Note 2) (): Denotes the dimensions with auto switch.

2 Fluororubber for Seals

Symbol
-X271

Material for seals is changed to fluororubber.

C□QS **Standard model no.** — **X271**

All series variations except non-rotating piston rod type of the CQS series is available. Specifications are the same as for each variation of CQS.

Fluororubber for seals

3 Long Stroke of Adjustable Extension Stroke Cylinder (-XC8)

Symbol
-X525

C□QS **Mounting** **Bore size** — **Stroke** **D(M)** — **X525**

Long stroke
of XC8

Specifications are the same as for -XC8 of the CQ2/CQS series. Refer to "Made to Order Common Specifications".
Note) For the tap mounting type (ø12 to ø25—without switch) and mounting bracket, please contact SMC.

ø12, ø16

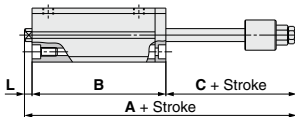

ø12, ø16

Symbol Stroke	A				B			C	L	Applicable stroke	
	35st	40st	45st	50st	35st	40st	45st				50st
Bore (mm)											
12	91.1 (96.1)	96.1 (101.1)	101.1 (106.1)	106.1 (111.1)	62 (67)	67 (72)	72 (77)	77 (82)	25.6	3.5	35, 40, 45, 50
16	91.5 (96.5)	96.5 (101.5)	101.5 (106.5)	106.5 (111.5)	62 (67)	67 (72)	72 (77)	77 (82)	26	3.5	

ø20, ø25

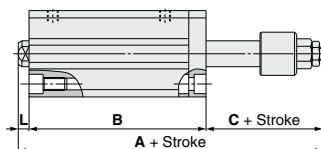

ø20, ø25

Symbol Stroke	A		B		C	L	Applicable stroke
	55 to 75st	80 to 100st	55 to 75st	80 to 100st			
Bore (mm)							
20	142.5 (152.5)	167.5 (177.5)	109 (119)	134 (144)	29	4.5	55 to 100
25	146 (156)	171 (181)	112 (122)	137 (147)	29	5	

Note 1) (): Denotes dimensions with auto switch.
Note 2) Applicable stroke is available in 5 mm increments.

4 Long Stroke of Adjustable Retraction Stroke Cylinder (-XC9)

Symbol
-X526

C□QS Mounting Bore size — Stroke D (M) — X526

Long stroke of XC9

Specifications are the same as for -XC9 of the CQS series.
Refer to "Made to Order Common Specifications".
Note) Please contact SMC for bracket type.

Dimensions

ø12, ø16

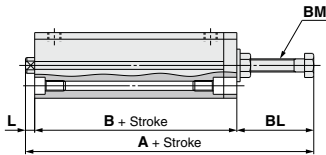

Symbol	A	B	L	BL	BM	Applicable stroke
Bore (mm) 12	69.8	37	3.5	29.3	M5 x 0.8	35, 40, 45, 50, 75, 100
16	69.5	37	3.5	29	M6 x 1.0	75, 100, 125, 150, 175, 200
20	76	41	4.5	30.5	M8 x 1.25	75, 100, 125, 150, 175, 200, 250, 300
25	78.5	44	5	29.5	M8 x 1.25	75, 100, 125, 150, 175, 200, 250, 300

Note 1) Intermediate stroke type (available in 5 mm increments) is for spacer so that dimensions are the same as for each type of 75, 100, 125, 150, 175, 200, 250, 300 stroke.

ø20, ø25

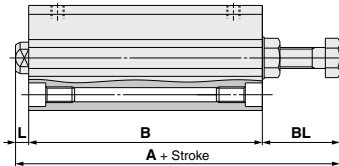

5 Intermediate Stroke of Double Rod Type

Symbol
-X633

C□QSW Standard model no. — X633
C□QSKW

* Specifications: Same as standard type.
Note) Please contact SMC for bracket type.

Dimensions

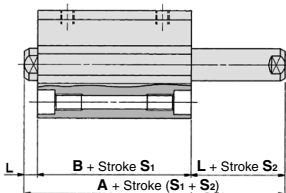

Symbol	C(D)QSW		C(D)QSKW		L	Stroke S ₁	Stroke S ₂
	A	B	A	B			
Bore (mm) 12	29 (34)	22 (27)	34 (39)	27 (32)	3.5	In the case of 5 to 30 stroke 5 mm intervals	In the case of 6 to 29 stroke 1 mm intervals
16	29 (34)	22 (27)	34 (39)	27 (32)	3.5	In the case of 5 to 30 stroke 5 mm intervals	In the case of 6 to 29 stroke 1 mm intervals
20	35 (45)	26 (36)	40 (50)	31 (41)	4.5	In the case of 5 to 50 stroke 5 mm intervals	In the case of 6 to 49 stroke 1 mm intervals
25	39 (49)	29 (39)	44 (54)	34 (44)	5	In the case of 5 to 50 stroke 5 mm intervals	In the case of 6 to 49 stroke 1 mm intervals

Note 1) (): Denotes the dimensions with auto switch.

Note 2) Installing a spacer inside the standard cylinder tube, stroke S₁ has 5 mm intervals for controlling intermediate strokes in 1 mm increments.

Example) In the case of CDQ2WB40-18D, stroke S₁ is 20 mm and stroke S₂ is 18 mm.

- CUJ
- CU
- CQS
- JCQ
- CQ2
- RQ
- CQM
- CQU
- MU

- D-□
- X□
- Technical Data



6 Long Stroke of Dual Stroke Single Rod Type

Symbol
-X636

C□QSB **Bore size** - **Stroke S₁** + **Stroke S₂-S₁** DC (M) - X636
 Long stroke of XC11

Applicable stroke

Bore size	Stroke
ø12, ø16	Max. stroke S ₂ : up to 50 mm
ø20, ø25	Max. stroke S ₂ : up to 100 mm

Specifications are the same as for -XC11 of the CQS series.
 Refer to "Made to Order Common Specifications".

Note) Please contact SMC for tap mounting type and bracket mounting type.

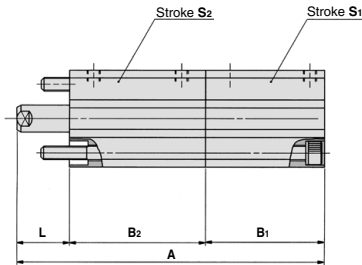

Bore size: ø12, ø16

Symbol	A	B ₁	B ₂	L	Stroke range	
					S ₁	S ₂
ø12	62.5 (67.5) + Stroke (S ₁ + S ₂)	17 (22) + Stroke S ₁	32 + Stroke S ₂	13.5	5 to 30	35 to 50
ø16	62.5 (67.5) + Stroke (S ₁ + S ₂)	17 (22) + Stroke S ₁	32 + Stroke S ₂	13.5	5 to 30	35 to 50

Bore size: ø20, ø25

Symbol	A		B ₁	B ₂		L	Stroke range	
	Stroke S ₂			Stroke S ₂			S ₁	S ₂
	55 to 75	80 to 100		55 to 75	80 to 100			
ø20	150 (160) + Stroke S ₁	175 (185) + Stroke S ₁	19.5 (29.5) + Stroke S ₁	116	141	14.5	5 to 50	55 to 100
ø25	156.5 (166.5) + Stroke S ₁	181.5 (191.5) + Stroke S ₁	22.5 (32.5) + Stroke S ₁	119	144	15	5 to 50	55 to 100

Note 1) (): Denotes the dimensions with auto switch.

Note 2) Applicable stroke is available in 5 mm increments.

7 Cylinder Tube: With Concave Boss on Head End

Symbol
-X1876

C□QS **Mounting** **Bore size** - **Stroke** D (C) (M)
 S (M) - X1876
 T (M)

With concave boss on head end

Specifications are the same as CQS.
 Note) CQS: Excluding ø12 and ø16.

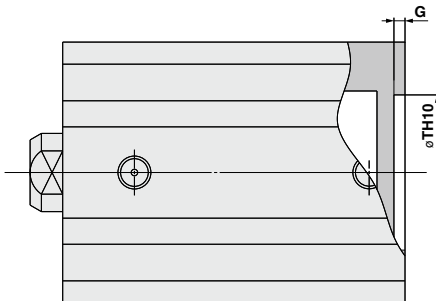

Series	CQS	
Bore size (mm)	TH10	G
20	19.3 + ^{0.084} / ₀	1.4
25	23.8 + ^{0.084} / ₀	1.4