

# Compact Guide Cylinder

ø16, ø32

New

RoHS

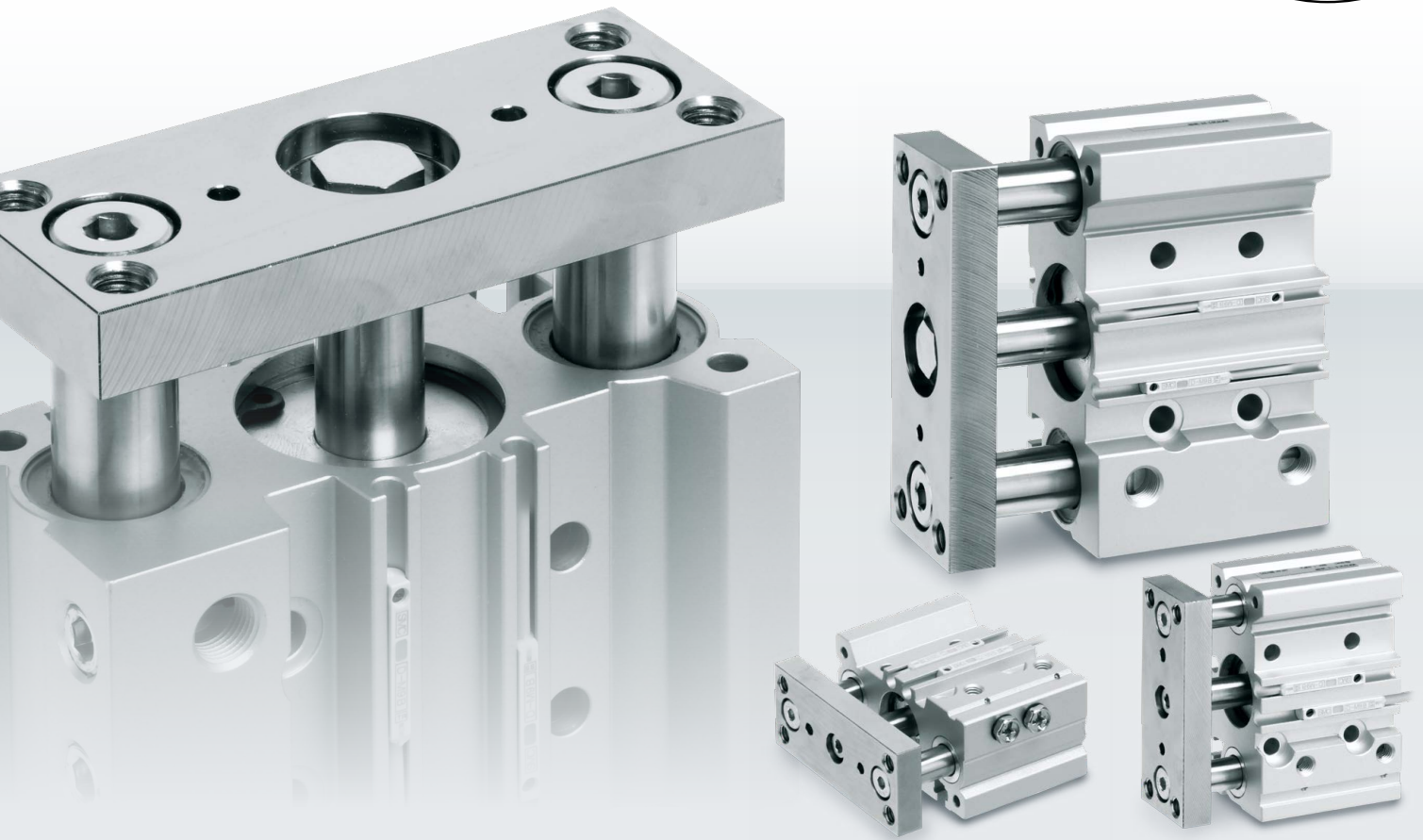

## Volume

Max. **28%** reduction

538 cm<sup>3</sup> → **390 cm<sup>3</sup>**

Compared with the MGPM, ø32, 25 mm stroke

## Weight

Max. **41%** reduction

0.32 kg → **0.19 kg**

Compared with the existing model (MGPM), ø16, 10 mm stroke

## High rigidity

**Optimized configuration achieved compact body with high rigidity**

Lateral load, allowable kinetic energy, and non-rotating accuracy are equivalent to the existing model (MGP-Z).

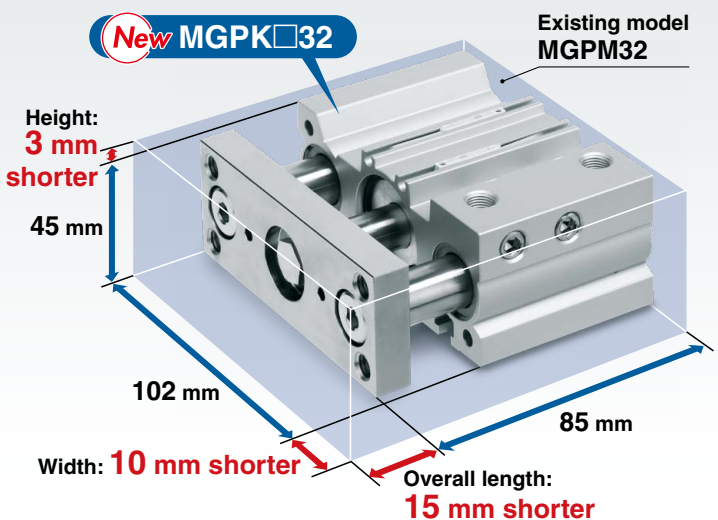

**MGPK Series**



CAT.ES20-270A

Plate thickness increased by up to **20%**  
Higher rigidity

$\varnothing 16$  7 mm  $\rightarrow$  **7.5 mm**  $\varnothing 32$  10 mm  $\rightarrow$  **12 mm**

Plate material is selectable.

- Carbon steel
- Aluminum alloy: Weight reduction

Lube-retainer is added to the guide rod.

- Lubrication is maintained by the Lube-retainer.
- Prevents the entry of foreign matter

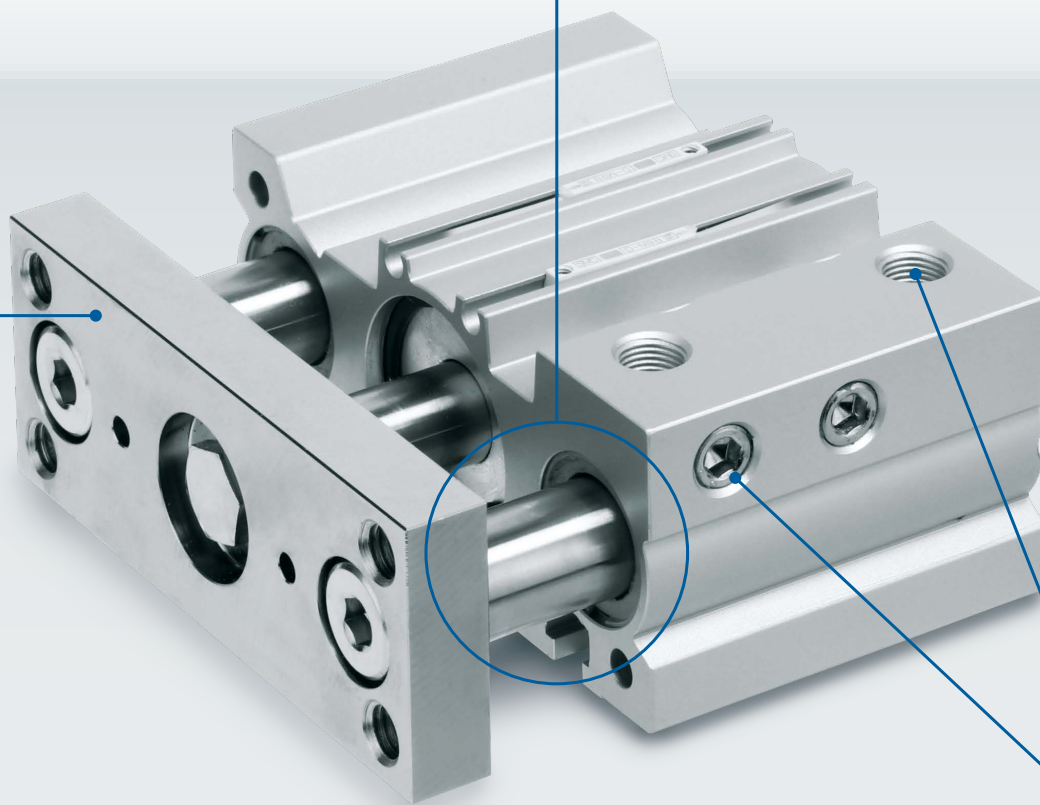
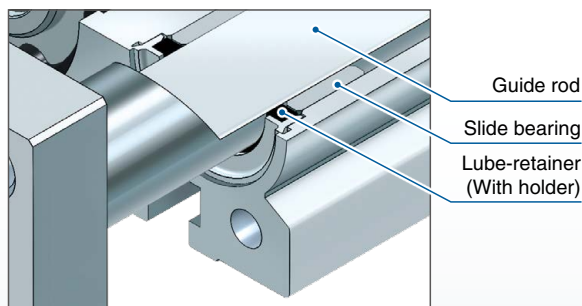

**2 types of porting can be selected.** (Top ported is available only for  $\varnothing 16$ .)

$\varnothing 16, \varnothing 32$

① Top ported

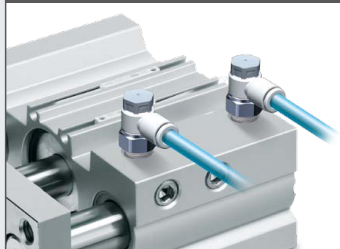

② Side ported



$\varnothing 16$

Top ported

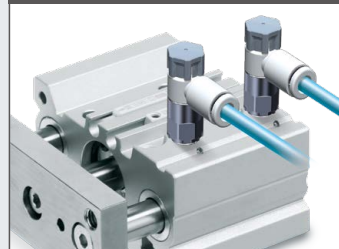

Since the only port is on the top surface, no plug is required on side, meaning the width of the body can be reduced.

## 4 types of mounting are possible.

- Easy positioning
- Knock pin holes provided on each mounting surface

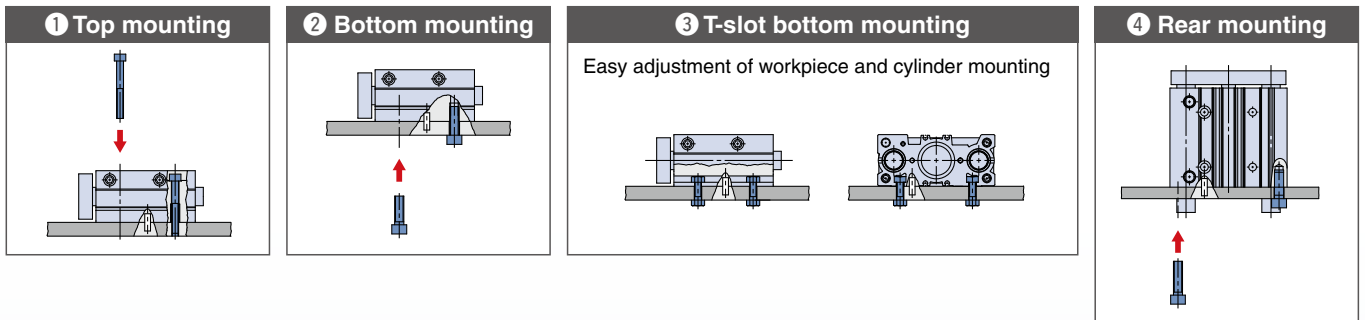

## Small auto switches can be directly mounted on 2 surfaces.

D-M9 □ D-A9 □

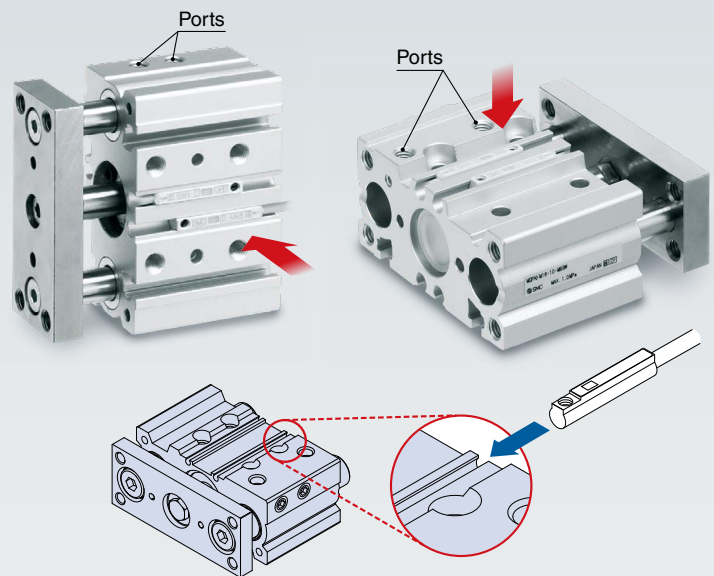

### Application Examples

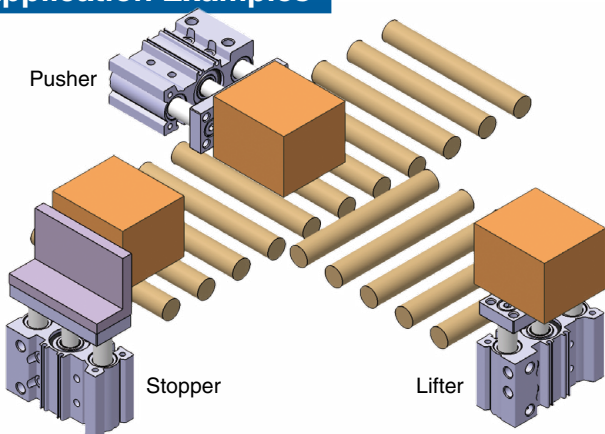

### CONTENTS

How to Order .....	p. 3
Specifications .....	p. 4
Weight .....	p. 5
Model Selection .....	p. 6
Construction .....	p. 12
Dimensions: $\varnothing 16$ .....	p. 13
Dimensions: $\varnothing 32$ .....	p. 14
Auto Switch Mounting .....	p. 15
Prior to Use .....	p. 16
Specific Product Precautions .....	p. 17

# Compact Guide Cylinder

# MGPK Series

∅16, ∅32



## How to Order

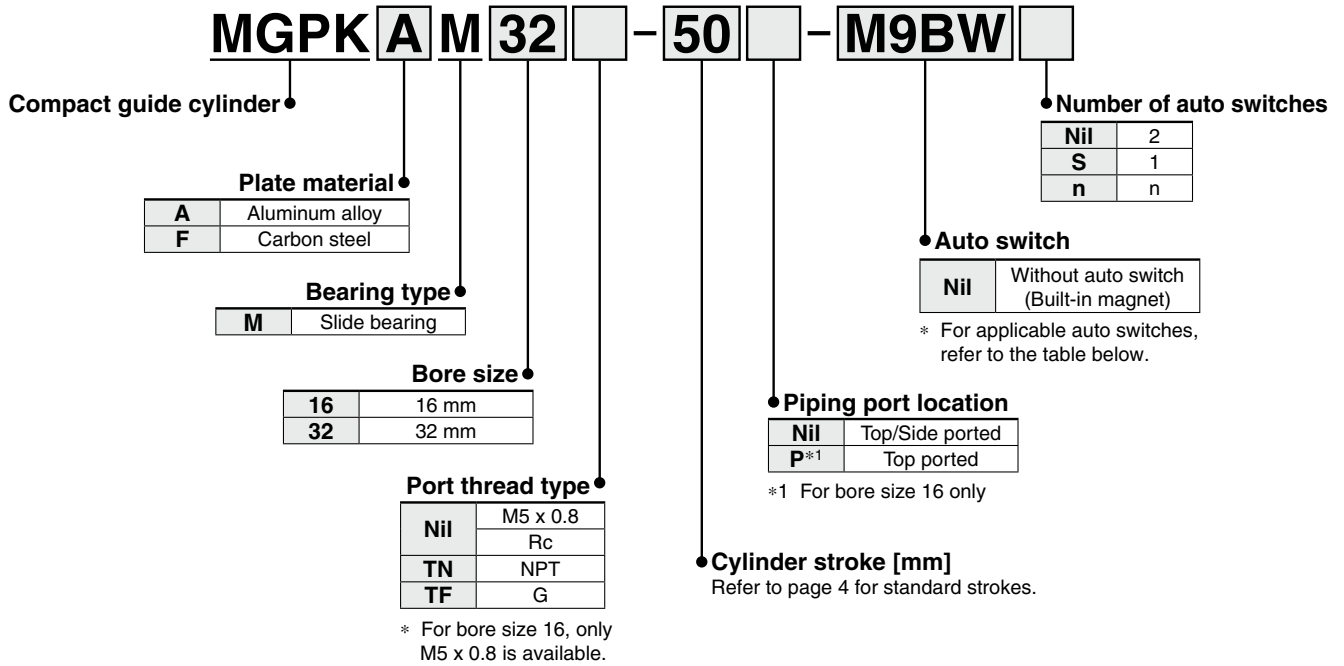

### Applicable Auto Switches/Refer to the Web Catalog for further information on auto switches.

Type	Special function	Electrical entry	Indicator light	Wiring (Output)	Load voltage		Auto switch model		Lead wire length [m]				Pre-wired connector	Applicable load					
					DC	AC	Perpendicular	In-line	0.5 (Nil)	1 (M)	3 (L)	5 (Z)							
Solid state auto switch	—	Grommet	Yes	3-wire (NPN)	24 V	5 V, 12 V	—	M9NV	M9N	●	●	●	○	○	IC circuit	Relay, PLC			
				3-wire (PNP)				M9PV	M9P	●	●	●	○	○					
				2-wire				M9BV	M9B	●	●	●	○	○					
	Diagnostic indication (2-color indicator)			3-wire (NPN)	5 V, 12 V	—	M9N WV	M9N W	●	●	●	○	○	○	IC circuit				
				3-wire (PNP)			M9P WV	M9P W	●	●	●	○	○						
				2-wire			M9B WV	M9B W	●	●	●	○	○						
	Water resistant (2-color indicator)			3-wire (NPN)	5 V, 12 V	—	M9NAV*1	M9NA*1	○	○	●	○	○	IC circuit					
				3-wire (PNP)			M9PAV*1	M9PA*1	○	○	●	○	○						
				2-wire			M9BAV*1	M9BA*1	○	○	●	○	○						
Reed auto switch	—	Grommet	Yes	3-wire (NPN equivalent)	24 V	5 V	—	A96V	A96	●	—	●	—	IC circuit	—				
				2-wire				12 V	100 V	A93V*2	A93	●	●			●	●	—	Relay, PLC
										100 V or less	A90V	A90	●			—	●		

\*1 Water-resistant type auto switches can be mounted on the above models, but SMC cannot guarantee water resistance.

\*2 The 1 m lead wire is only applicable to the D-A93.

\* Lead wire length symbols: 0.5 m..... Nil (Example) M9NW \* Solid state auto switches marked with "○" are produced upon receipt of order.  
 1 m..... M (Example) M9NWM  
 3 m..... L (Example) M9NWL  
 5 m..... Z (Example) M9NWZ

\* For details on auto switches with pre-wired connectors, refer to the Web Catalog.

\* Auto switches are shipped together with the product but do not come assembled.



## Symbol

Rubber bumper

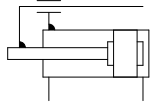

## Specifications

Bore size [mm]	16	32
<b>Action</b>	Double acting	
<b>Fluid</b>	Air	
<b>Proof pressure</b>	1.5 MPa	
<b>Max. operating pressure</b>	1.0 MPa	
<b>Min. operating pressure</b>	0.12 MPa	0.1 MPa
<b>Ambient and fluid temperatures</b>	-10 to 60°C (No freezing)	
<b>Piston speed*1</b>	50 to 500 mm/s	
<b>Cushion</b>	Rubber bumper on both ends	
<b>Lubrication</b>	Not required (Non-lube)	
<b>Stroke length tolerance</b>	0 to $^{+1.5}_0$ mm	

\*1 Maximum speed with no load. Depending on the operating conditions, the piston speed may not be satisfied.

## Standard Strokes

Bore size [mm]	Standard stroke [mm]
<b>16</b>	10, 20, 30, 40, 50, 75, 100, 125, 150
<b>32</b>	25, 50, 75, 100, 125, 150, 175, 200

## Manufacturing of Intermediate Strokes

<b>Description</b>	Spacer installation type Spacers are installed in the standard stroke cylinder. · Stroke can be modified in 1 mm increments.	
<b>Part no.</b>	Refer to the "How to Order" for the standard model numbers.	
<b>Applicable stroke [mm]</b>	ø16	1 to 149
	ø32	1 to 199
<b>Example</b>	Part no.: MGPKAM16-39 A 1 mm spacer is installed in MGPKAM16-40. Dimension C is 68.5 mm.	

## Theoretical Output

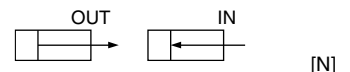

Bore size [mm]	Rod size [mm]	Operating direction	Piston area [mm <sup>2</sup> ]	Operating pressure [MPa]										
				0.2	0.3	0.4	0.5	0.6	0.7	0.8	0.9	1.0		
<b>16</b>	8	OUT	201	40	60	80	101	121	141	161	181	201		
		IN	151	30	45	60	75	90	106	121	136	151		
<b>32</b>	14	OUT	804	161	241	322	402	483	563	643	724	804		
		IN	650	130	195	260	325	390	455	520	585	650		

\* Theoretical output [N] = Pressure [MPa] x Piston area [mm<sup>2</sup>]

Refer to page 15 for cylinders with auto switches.

- Auto Switch Proper Mounting Position (Detection at stroke end) and Mounting Height
- Minimum Stroke for Auto Switch Mounting
- Operating Range
- Auto Switch Mounting

# MGPK Series

## Weight

Bore size [mm]	Piping port location	Plate material	Standard stroke [mm]											[kg]
			10	20	25	30	40	50	75	100	125	150	175	200
16	Top/Side ported	Carbon steel	0.23	0.27	—	0.31	0.35	0.39	0.51	0.61	0.74	0.84	—	—
		Aluminum alloy	0.19	0.23	—	0.27	0.31	0.35	0.46	0.56	0.69	0.79	—	—
	Top ported	Carbon steel	0.23	0.27	—	0.31	0.35	0.39	0.51	0.61	0.74	0.84	—	—
		Aluminum alloy	0.19	0.23	—	0.27	0.31	0.35	0.46	0.56	0.69	0.79	—	—
32	Top/Side ported	Carbon steel	—	—	1.07	—	—	1.34	1.67	1.93	2.22	2.49	2.75	3.02
		Aluminum alloy	—	—	0.87	—	—	1.14	1.47	1.73	2.02	2.29	2.55	2.82

## Allowable Rotational Torque of Plate

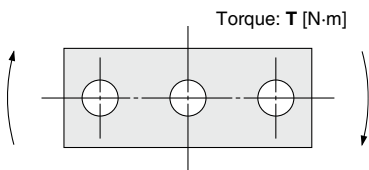

Bore size [mm]	Stroke [mm]											[N·m]
	10	20	25	30	40	50	75	100	125	150	175	200
16	0.69	0.58	—	0.49	0.43	0.38	0.69	0.58	0.50	0.44	—	—
32	—	—	6.35	—	—	5.13	5.69	4.97	4.42	3.98	3.61	3.31

## Non-rotating Accuracy of Plate

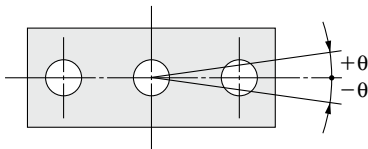

Non-rotating accuracy  $\theta$  when retracted and when no load is applied should be not more than the values shown in the table.

Bore size [mm]	Non-rotating accuracy $\theta$
16	$\pm 0.07^\circ$
32	$\pm 0.05^\circ$

# MGPK Series Model Selection

## Selection Conditions

Mounting orientation	Vertical		Horizontal	
	200 or less	400	200 or less	400
Max. speed [mm/s]	200 or less	400	200 or less	400
Plate material	Carbon steel	<b>1, 2</b>	<b>5, 6</b>	<b>7, 8</b>
	Aluminum alloy	<b>9, 10</b>	<b>11, 12</b>	<b>13, 14</b>

### Selection Example 1 (Vertical Mounting)

#### Selection conditions

Mounting: Vertical  
Stroke: 30 mm stroke  
Max. speed: 200 mm/s  
Load mass: 2 kg  
Eccentric distance: 80 mm

Find the point of intersection for the load mass of 2 kg and the eccentric distance of 80 mm on graph **1**, based on vertical mounting, 30 mm stroke, and the speed of 200 mm/s.

→ The **MGPKFM16-30** should be selected.

#### **1** 50 mm stroke or less, V = 200 mm/s or less

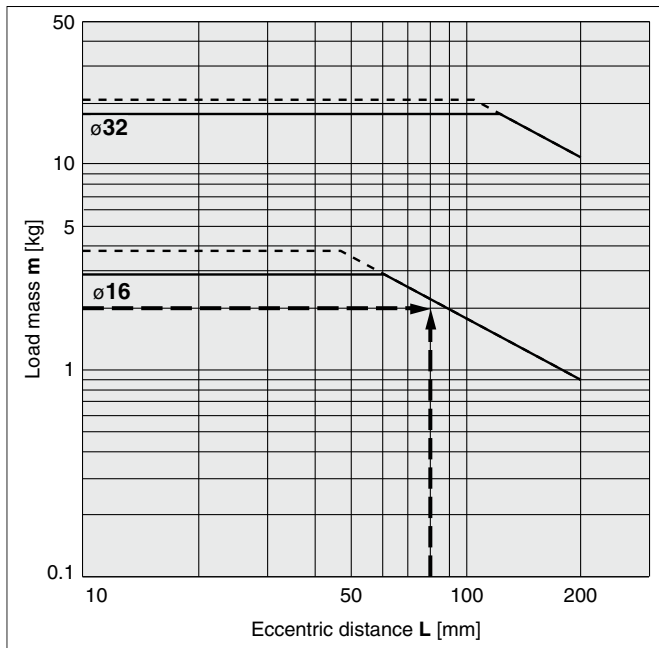

### Selection Example 2 (Horizontal Mounting)

#### Selection conditions

Mounting: Horizontal  
Distance between plate and load center of gravity: 50 mm  
Max. speed: 200 mm/s  
Load mass: 10 kg  
Stroke: 30 mm stroke

Find the point of intersection for the load mass of 10 kg and 30 mm stroke on graph **5**, based on horizontal mounting, the distance of 50 mm between the plate and load center of gravity, and the speed of 200 mm/s.

→ The **MGPKFM32-30** should be selected.

#### **5** L = 50 mm, V = 200 mm/s or less

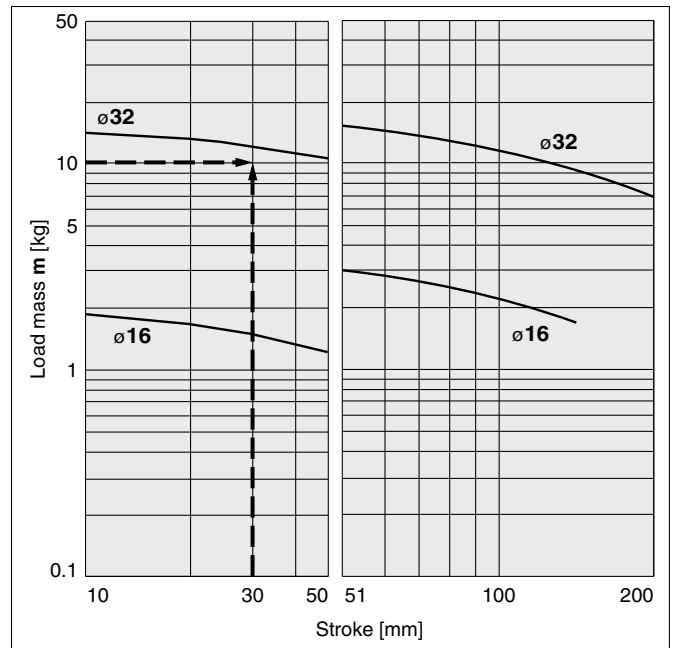

When the maximum speed exceeds 200 mm/s, the allowable load mass is determined by multiplying the value shown in the graph at 400 mm/s by the coefficient listed in the table below.

Max. speed	Up to 300 mm/s	Up to 400 mm/s	Up to 500 mm/s
Coefficient	1.7	1	0.6

# MGPK Series

## Vertical Mounting

Plate Material **Carbon Steel**

—— Operating pressure: 0.4 MPa    - - - - - Operating pressure: 0.5 MPa or more

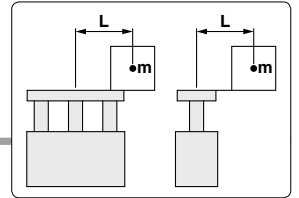

### MGPKFM16, 32

#### 1 50 mm stroke or less, V = 200 mm/s or less

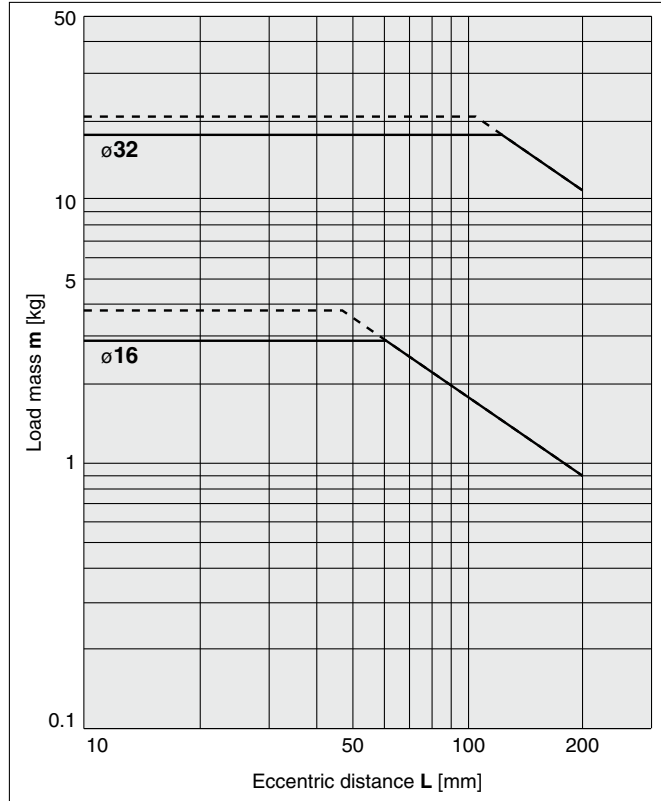

#### 2 Over 50 mm stroke, V = 200 mm/s or less

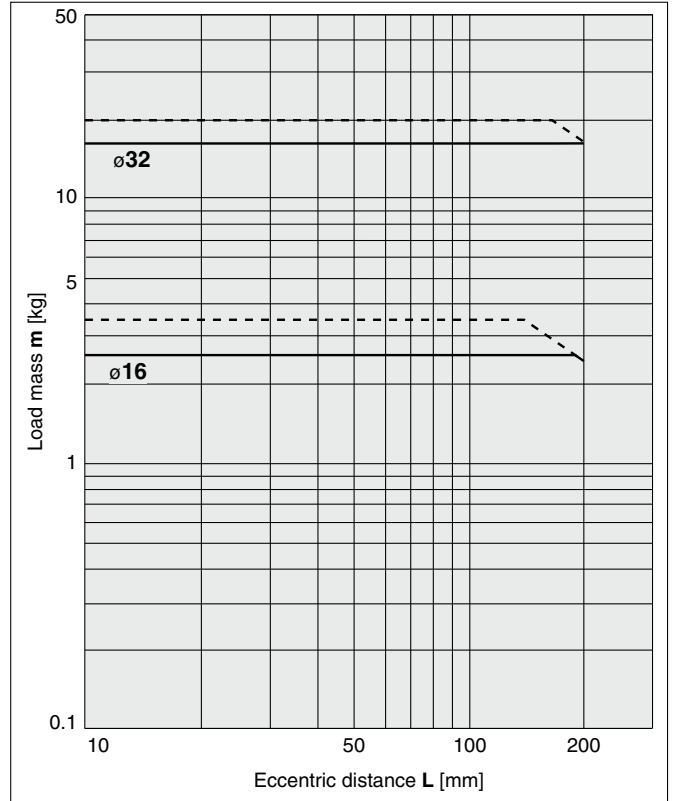

#### 3 50 mm stroke or less, V = 400 mm/s

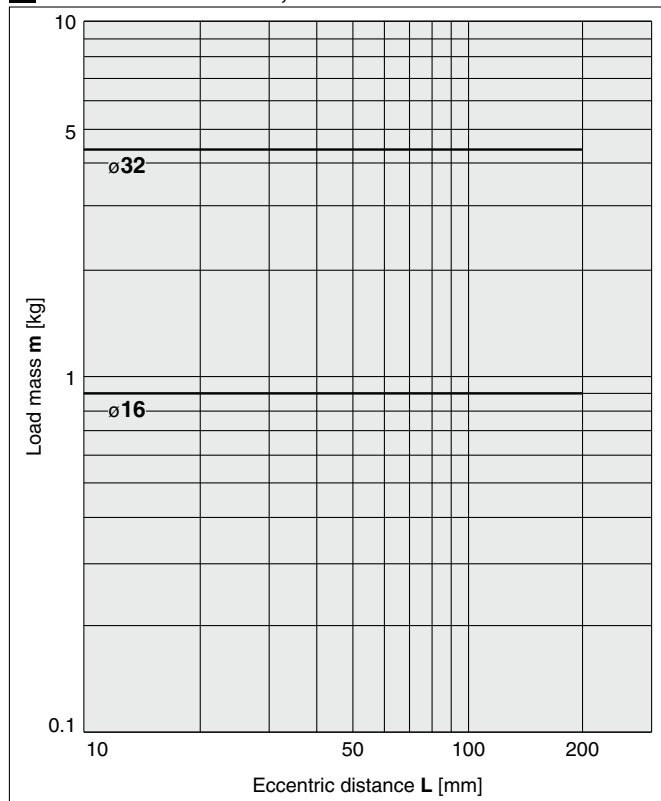

#### 4 Over 50 mm stroke, V = 400 mm/s

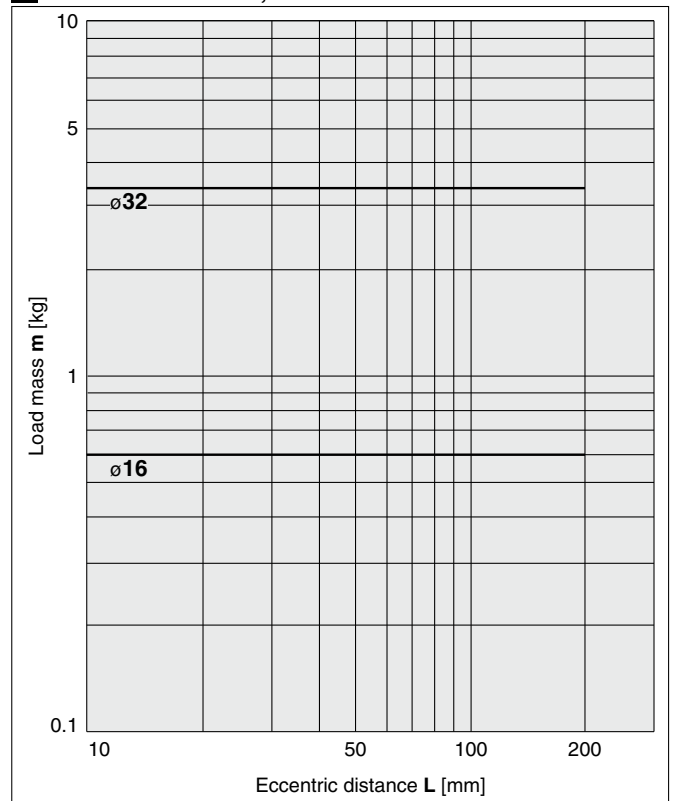



**Horizontal Mounting** Plate Material **Carbon Steel**

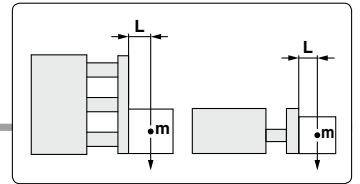

**MGPKFM16, 32**

**5** L = 50 mm, V = 200 mm/s or less

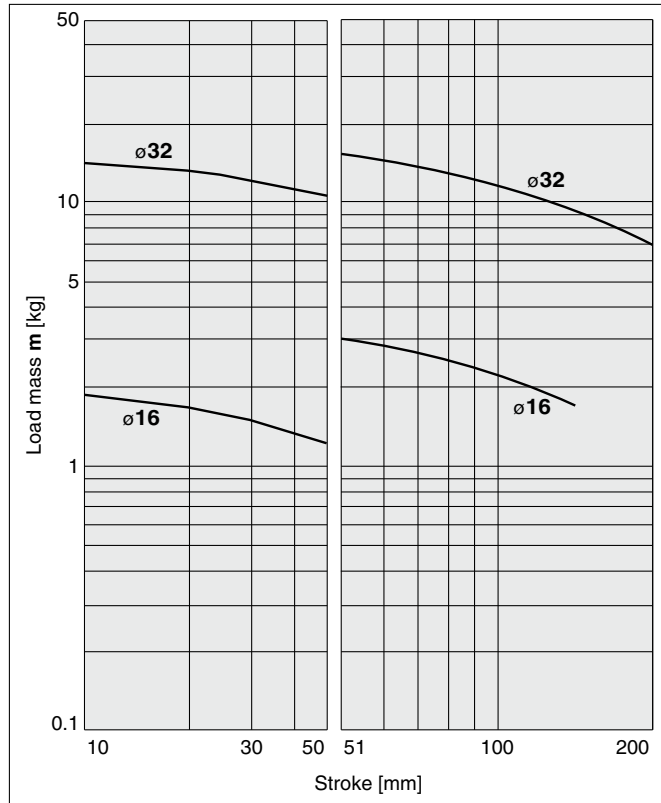

**6** L = 100 mm, V = 200 mm/s or less

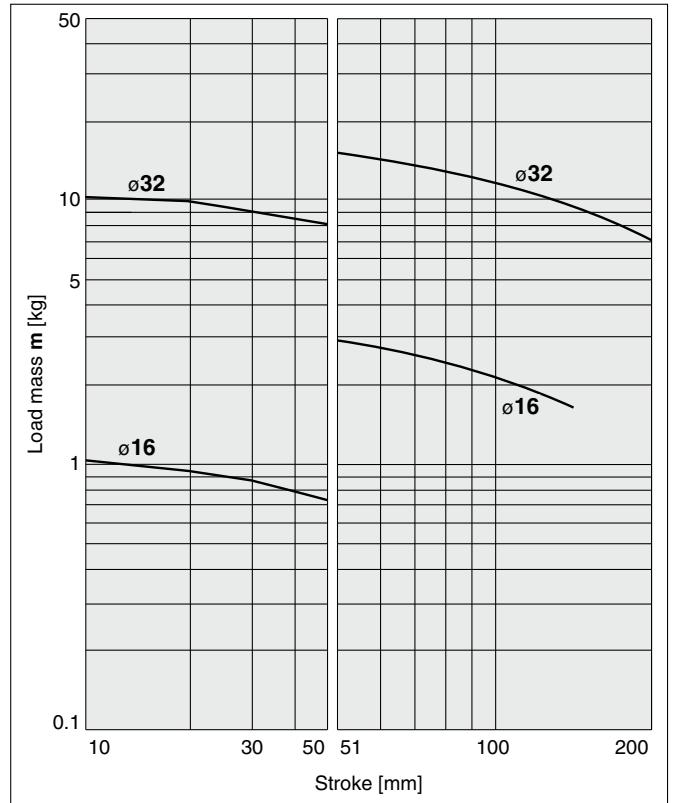

**7** L = 50 mm, V = 400 mm/s

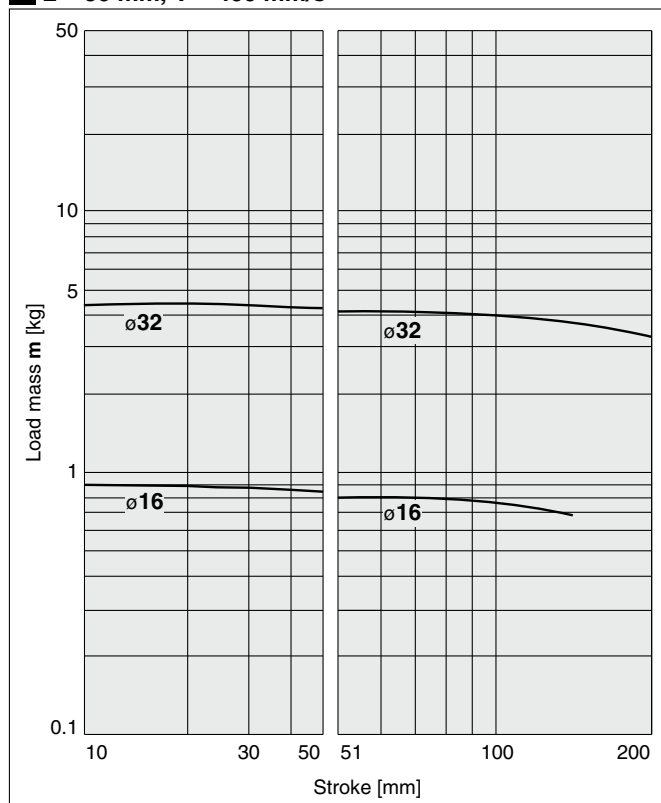

**8** L = 100 mm, V = 400 mm/s

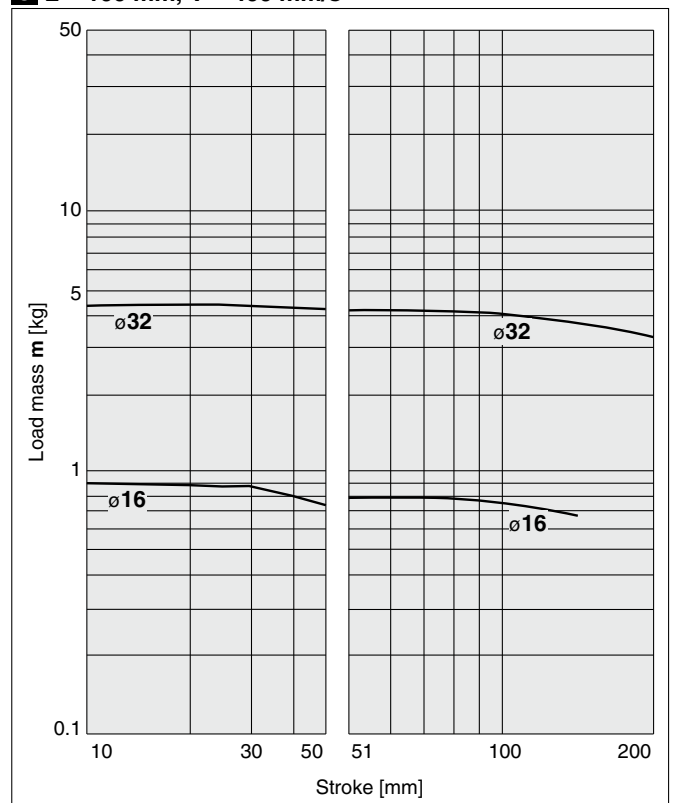

# MGPK Series

## Vertical Mounting

Plate Material **Aluminum Alloy**

—— Operating pressure: 0.4 MPa    - - - - - Operating pressure: 0.5 MPa or more

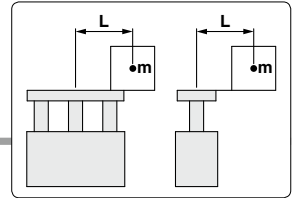

### MGPKAM16, 32

**9** 50 mm stroke or less, V = 200 mm/s or less

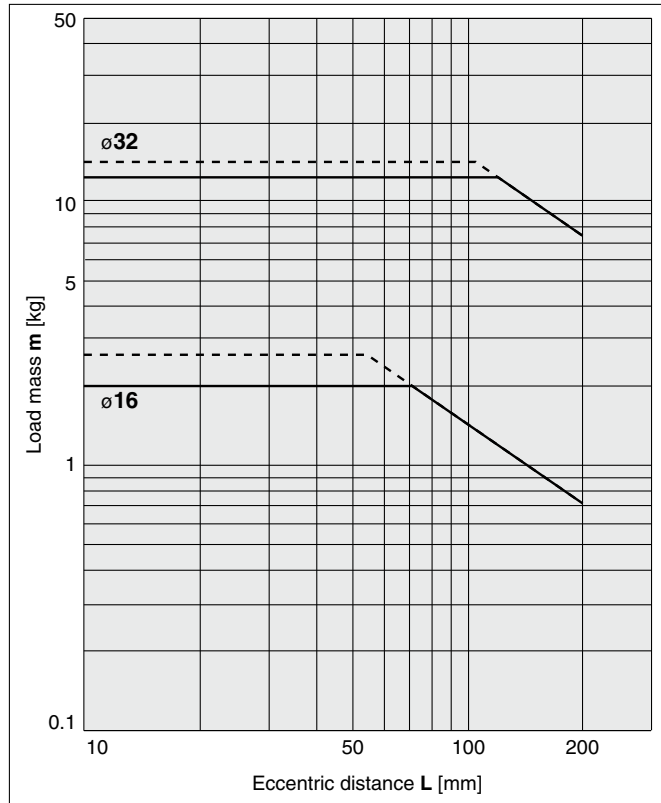

**10** Over 50 mm stroke, V = 200 mm/s or less

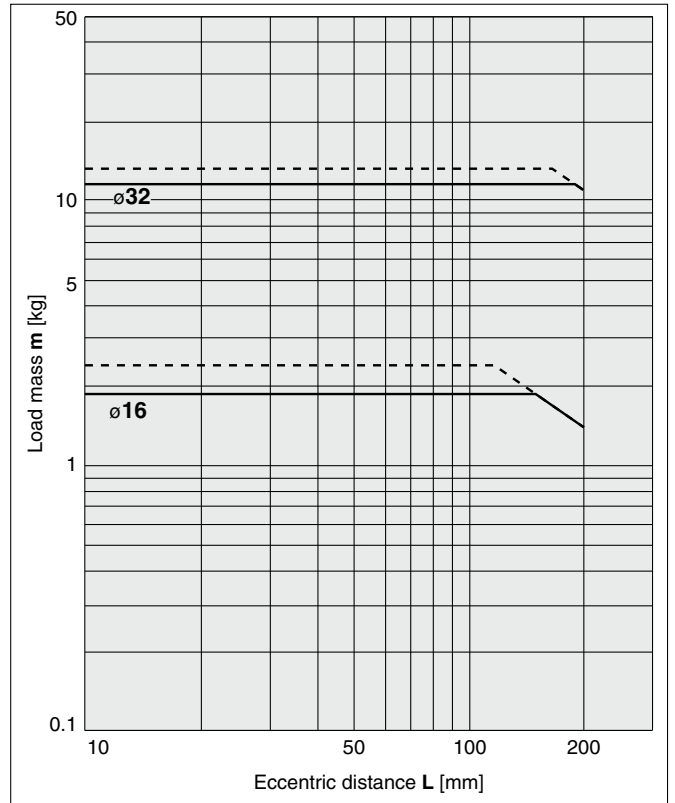

**11** 50 mm stroke or less, V = 400 mm/s

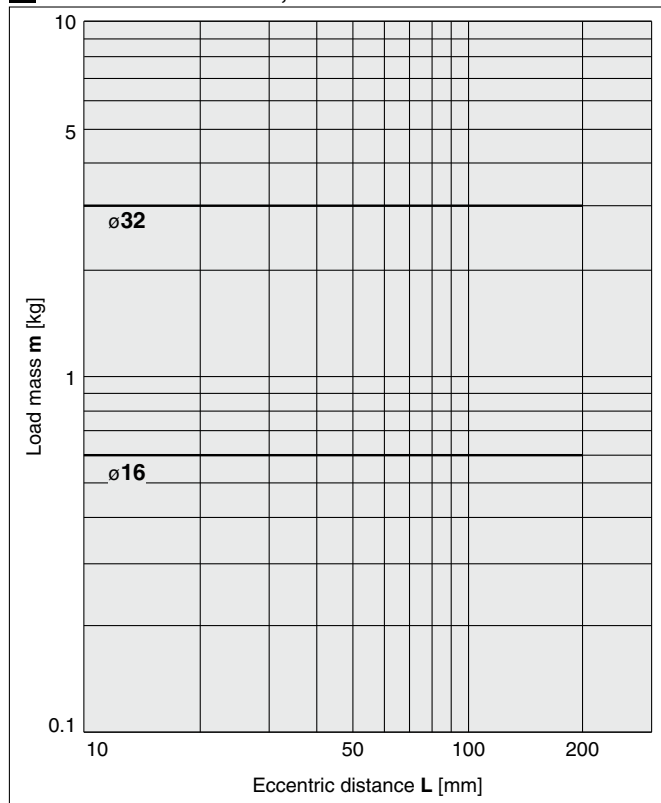

**12** Over 50 mm stroke, V = 400 mm/s

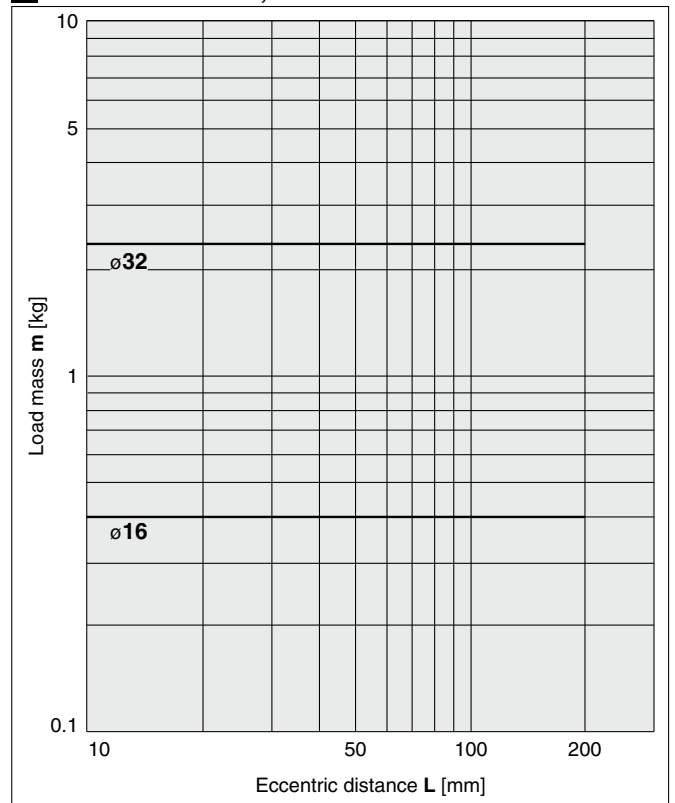

**Horizontal Mounting** Plate Material **Aluminum Alloy**

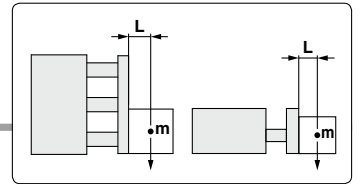

**MGPKAM16, 32**

**13** L = 50 mm, V = 200 mm/s or less

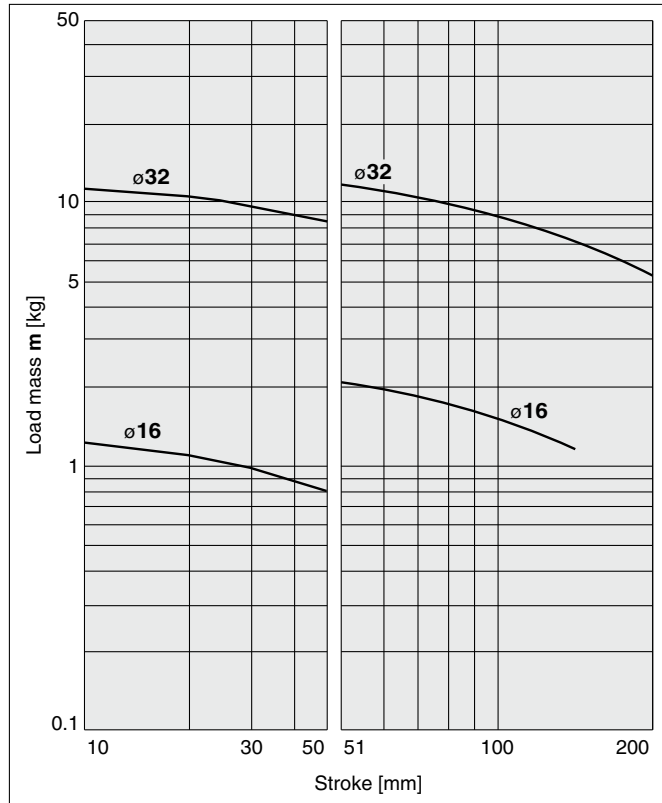

**14** L = 100 mm, V = 200 mm/s or less

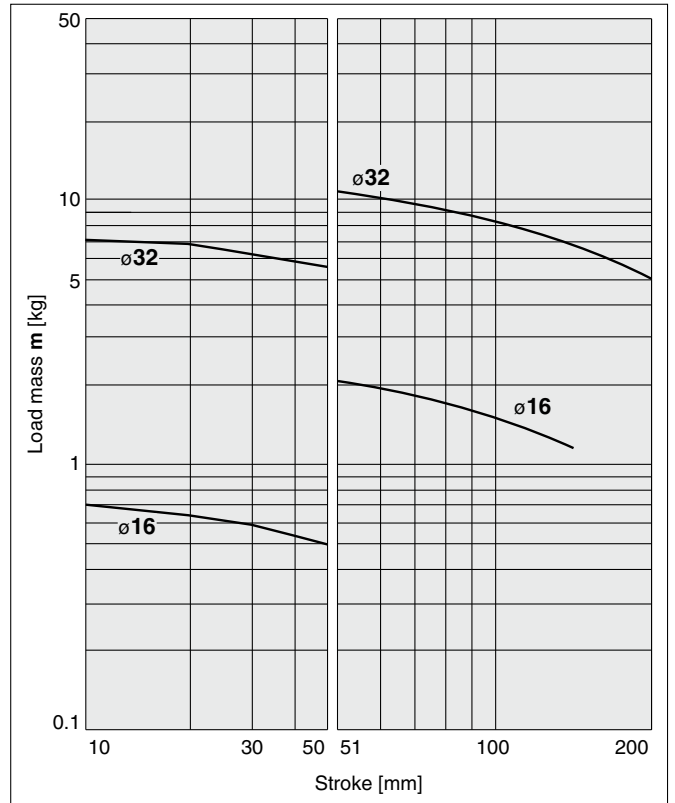

**15** L = 50 mm, V = 400 mm/s

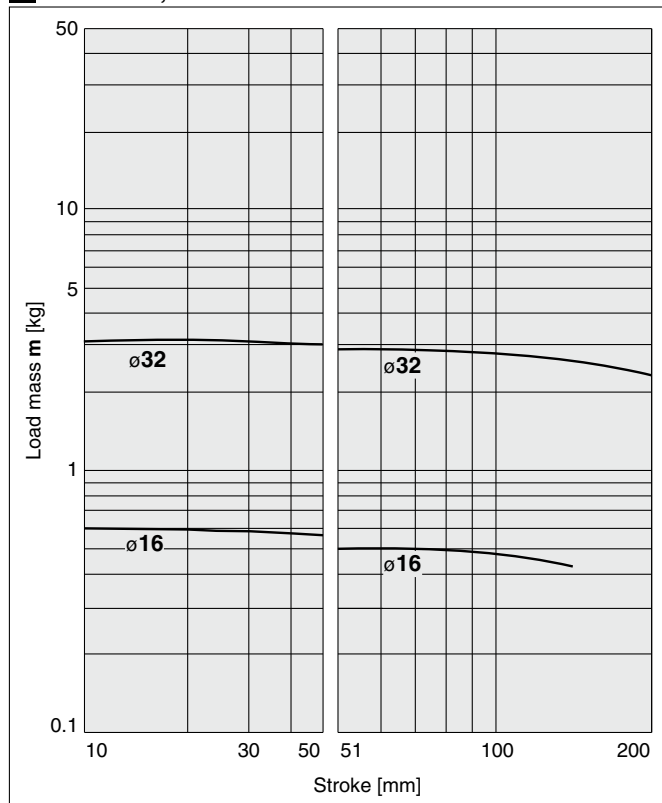

**16** L = 100 mm, V = 400 mm/s

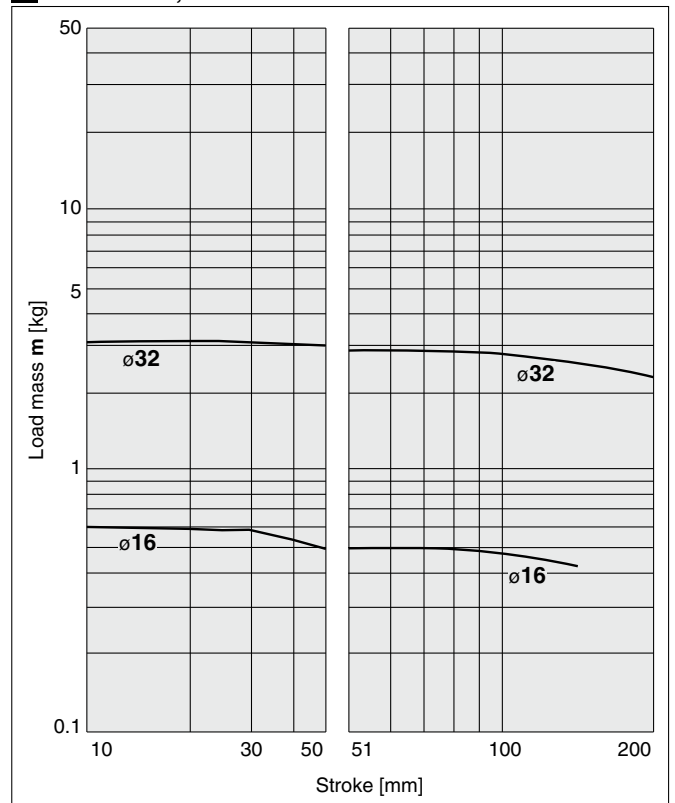

# MGPK Series

## Operating Range when Used as a Stopper

### Bore Size $\phi 16$ : MGPKFM16 (Plate Material: Carbon Steel)

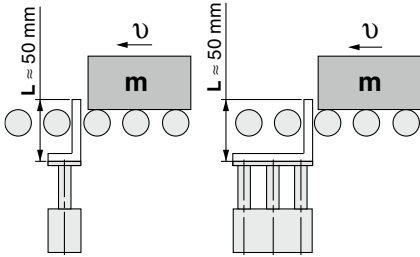

\* When selecting a model with a longer  $L$  dimension, be sure to choose a bore size which is sufficiently large.

#### ⚠ Caution

##### Handling Precautions

1. When used as a stopper, select a model with a stroke of 30 mm or less.
2. The MGPKA16 (Plate material: Aluminum alloy) cannot be used as a stopper.

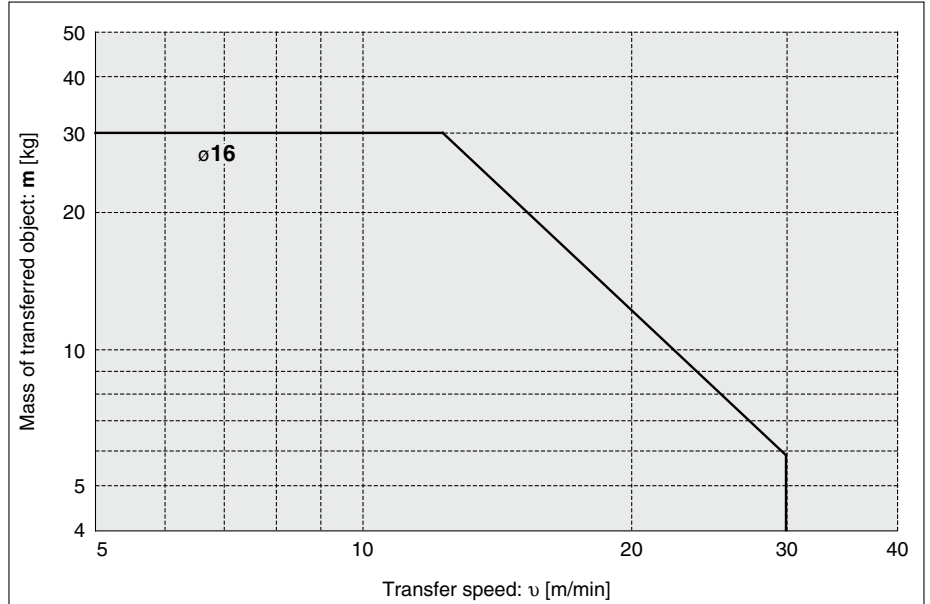

### Bore Size $\phi 32$ : MGPKFM32 (Plate Material: Carbon Steel)

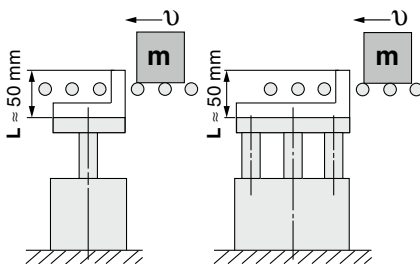

\* When selecting a model with a longer  $L$  dimension, be sure to choose a bore size which is sufficiently large.

#### ⚠ Caution

##### Handling Precautions

1. When used as a stopper, select a model with a stroke of 50 mm or less.
2. The MGPKA32 (Plate material: Aluminum alloy) cannot be used as a stopper.

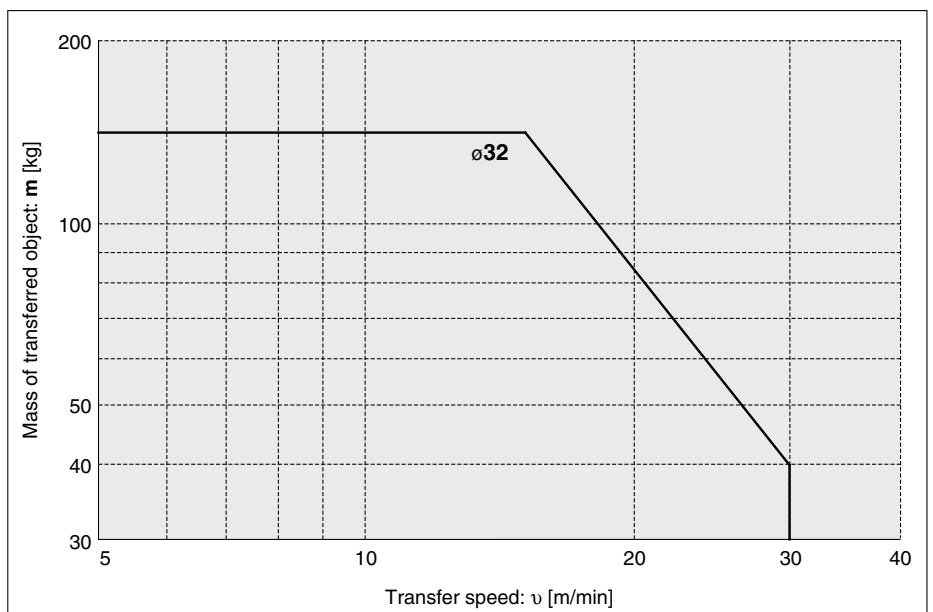

\* Refer to graphs 13 and 15 if line pressure is applied by a roller conveyor after the workpiece is stopped.

## Construction

### MGPKM□

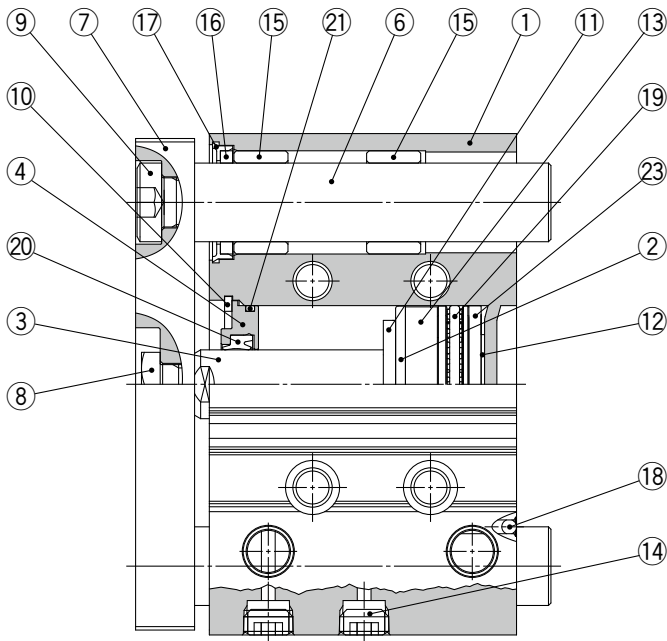

100 mm stroke or less

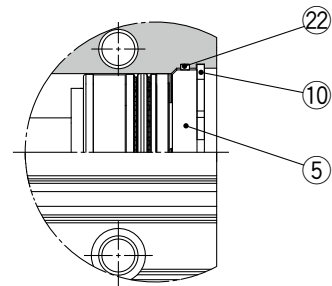

101 mm stroke or more

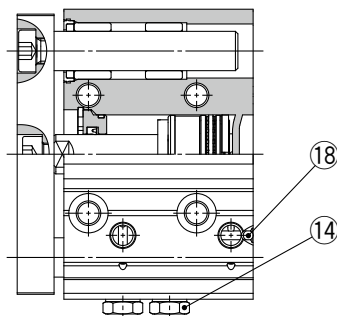

ø16, Top/Side-ported type

### Component Parts

No.	Description	Material	Note
1	<b>Body</b>	Aluminum alloy	Hard anodized
2	<b>Piston</b>	Aluminum alloy	
3	<b>Piston rod</b>	Stainless steel	ø16
		Carbon steel	ø32: Hard chrome plating
4	<b>Collar</b>	Aluminum alloy	Chromating
5	<b>Head cover</b>	Aluminum alloy	101 st or more: Chromating
6	<b>Guide rod</b>	Carbon steel	Hard chrome plating
7	<b>Plate</b>	Aluminum alloy	MGPKA: Anodized
		Carbon steel	MGPKF: Electroless nickel plating
8	<b>Plate mounting bolt</b>	Carbon steel	Nickel plating
9	<b>Guide bolt</b>	Carbon steel	Nickel plating
10	<b>Retaining ring</b>	Carbon tool steel	Phosphate coating
11	<b>Bumper A</b>	Urethane	
12	<b>Bumper B</b>	Urethane	
13	<b>Magnet</b>	—	
14	<b>Plug</b>	Carbon steel	ø16 (Top/Side-ported type): Nickel plating
		Hexagon socket head taper plug	Carbon steel ø32: Nickel plating
15	<b>Slide bearing</b>	Bearing alloy	

### Component Parts

No.	Description	Material	Note
16	<b>Felt</b>	—	
17	<b>Holder</b>	Resin	
18	<b>Steel ball</b>	Carbon steel	ø16 (Top/Side-ported type), ø32
19	<b>Piston seal</b>	NBR	
20	<b>Rod seal</b>	NBR	
21	<b>Gasket A</b>	NBR	
22	<b>Gasket B</b>	NBR	101 st or more
23	<b>Wear ring</b>	Resin	

### Replacement Parts: Seal Kit

Bore size [mm]	Kit no.	Contents
16	MGPK16-PS	Set of nos. 19, 20, 21, 22
32	MGPK32-PS	

\* The seal kit includes 19 to 22. Order the seal kit based on each bore size.

\* The seal kit does not include a grease pack. Order it separately.

**Grease pack part number: GR-S-010 (10 g)**

# MGPK Series

Dimensions:  $\varnothing 16$

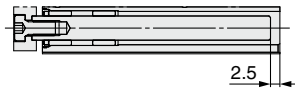
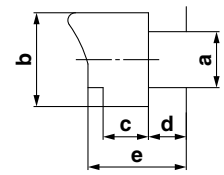
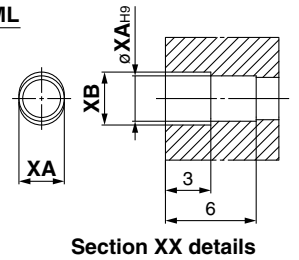
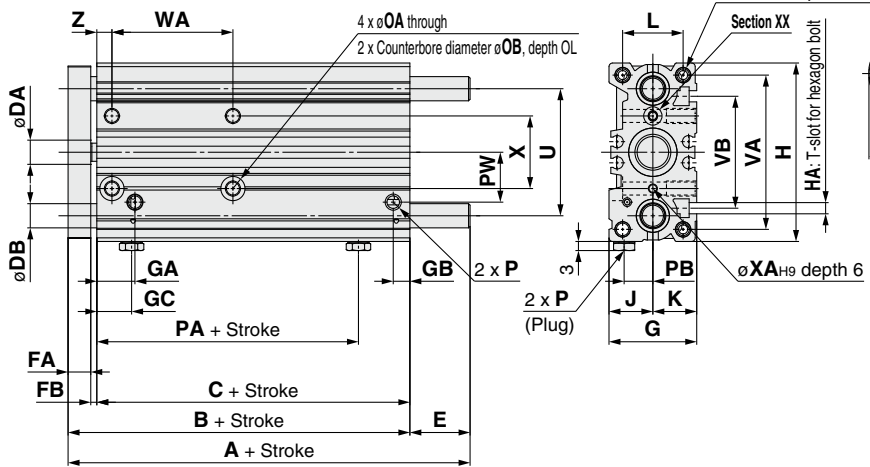
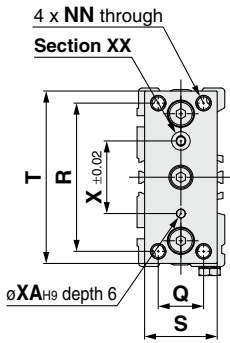
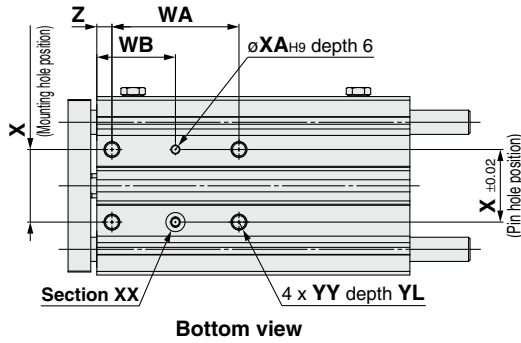
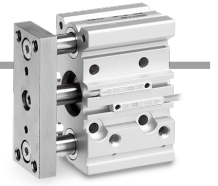

[mm]					
Bore size [mm]	a	b	c	d	e
16	3.7	6.2	3	2.5	6.5

- \* The use of a slot (width XA, length XB, depth 3) allows for a relaxed pin pitch tolerance, with the pin hole ( $\varnothing XA_{H9}$ , depth 6) as the reference, without affecting mounting accuracy.
- \* For intermediate strokes other than standard strokes, refer to the "Manufacturing of Intermediate Strokes" on page 4.

Bore size [mm]	Standard stroke		A			B		C		DA	DB	E			FA	FB	G	GA
			50 st or less	Over 50 st 100 st or less	Over 100 st	100 st or less	Over 100 st	100 st or less	Over 100 st			50 st or less	Over 50 st 100 st or less	Over 100 st				
16	10, 20, 30, 40, 50, 75, 100, 125, 150		38	58	86	38	41	28.5	31.5	8	8	0	20	45	7.5	2	29	12.5

  

Bore size [mm]	GB		GC	H	HA	J	K	L	MM	ML	NN	OA	OB	OL	P	PA	PB	PW	Q	R	S
	100 st or less	Over 100 st																			
16	5.5	7.5	11.5	59	M3.5	14.5	14.5	20	M5 x 0.8	11	M5 x 0.8	4.3	8	4.5	M5 x 0.8	11.5	9.5	16.5	15	49	24

  

Bore size [mm]	T	U	VA	VB	WA				WB				X	XA	XB	YY	YL	Z
					10 st or less	Over 10 st 30 st or less	Over 30 st 100 st or less	Over 100 st	10 st or less	Over 10 st 30 st or less	Over 30 st 100 st or less	Over 100 st						
16	57	42	51	37	20	22	42	110	15	16	26	60	24	3	3.5	M5 x 0.8	10	5

Dimensions: **∅32**

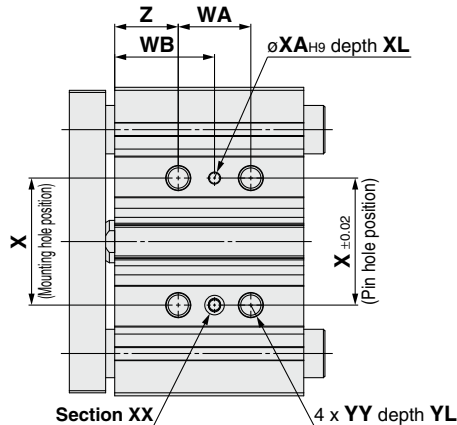
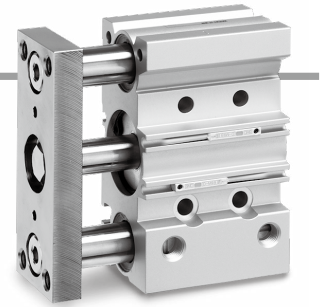

Bottom view

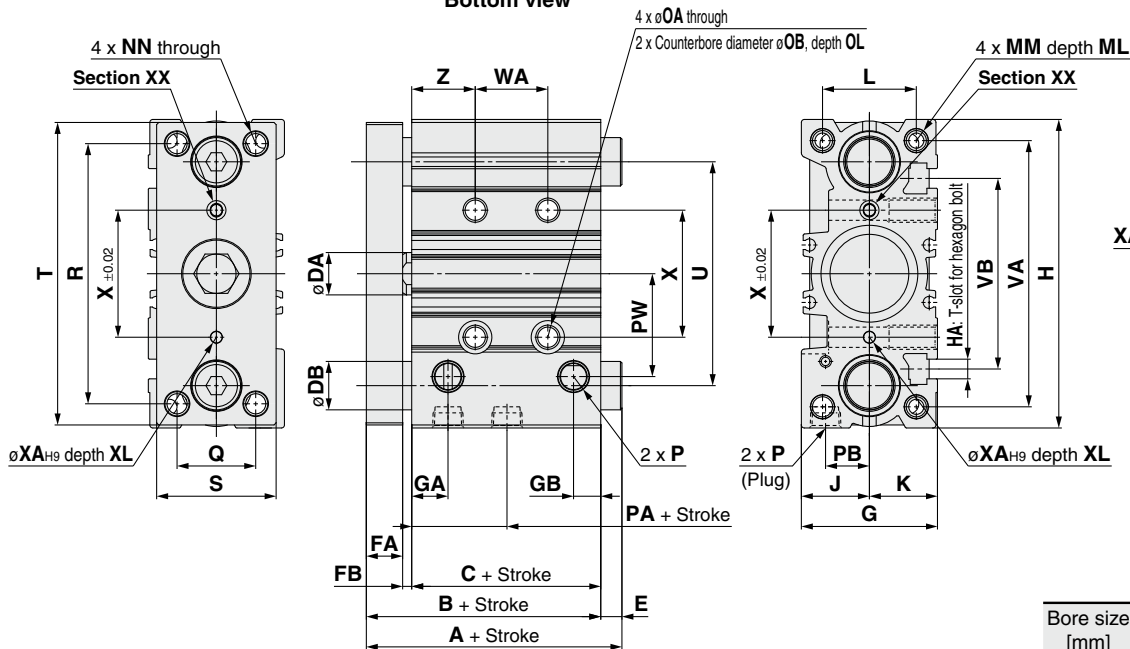

Section XX details

T-slot dimensions

[mm]					
Bore size [mm]	a	b	c	d	e
32	6.5	10.2	5.5	3.5	9.5

- \* The use of a slot (width XA, length XB, depth XC) allows for a relaxed pin pitch tolerance, with the pin hole (∅XA<sub>H9</sub>, depth XL) as the reference, without affecting mounting accuracy.
- \* For intermediate strokes other than standard strokes, refer to the "Manufacturing of Intermediate Strokes" on page 4.
- \* Choice of Rc, NPT, G port is available. (Refer to page 3.)

[mm]																		
Bore size [mm]	Standard stroke	A		B		C		DA	DB	E			FA	FB	G	GA	GB	H
		50 st or less	Over 50 st	100 st or less	Over 100 st	100 st or less	Over 100 st			50 st or less	Over 50 st or less	Over 100 st						
32	25, 50, 75, 100, 125, 150, 175, 200	60	78	52.5	55	37.5	40	14	16	7.5	25.5	23	12	3	45	12	9	102

Bore size [mm]	HA	J	K	L	MM	ML	NN	OA	OB	OL	P			PA	PB	PW	Q	R	S	T
											Nil	TN	TF							
32	M6	22.5	22.5	31	M8 x 1.25	20	M8 x 1.25	6.7	11	9	Rc1/8	NPT1/8	G1/8	6.5	14.5	34	26	86	39.5	100

Bore size [mm]	U	VA	VB	WA			WB			X	XA	XB	XC	XL	YY	YL	Z
				25 st or less	Over 25 st or less	Over 100 st	25 st or less	Over 25 st or less	Over 100 st								
32	74	88	63	24	48	124	33	45	83	42	4	4.5	3	6	M8 x 1.25	16	21

# MGPK Series Auto Switch Mounting

## Auto Switch Proper Mounting Position (Detection at stroke end) and Mounting Height

D-M9□/M9□V  
D-M9□W/M9□WV  
D-M9□A/M9□AV  
D-A9□/A9□V

ø16, ø32

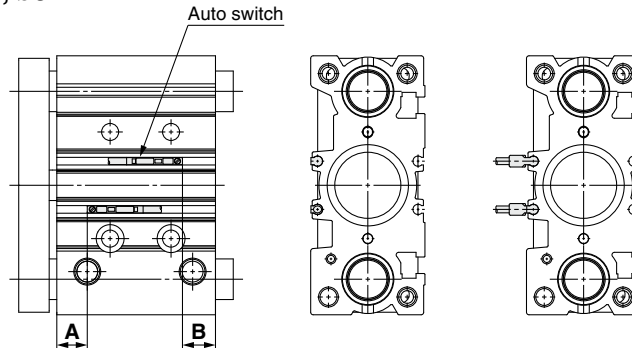

### Auto Switch Proper Mounting Position [mm]

Bore size	D-M9□ D-M9□W D-M9□A		D-M9□V D-M9□WV D-M9□AV		D-A9□ D-A9□V	
	A	B		A	B	
		100 mm stroke or less	101 mm stroke or more		100 mm stroke or less	101 mm stroke or more
16	9	7.5	10.5	5	3.5	6.5
32	12	13	15.5	8	9	11.5

### Auto Switch Mounting Height [mm]

Bore size	D-M9□V D-M9□WV D-M9□AV	D-A9□V
	Hs	Hs
16	21.5	19
32	29.5	27

\* Adjust the auto switch after confirming the operating conditions in the actual setting.

### Minimum Stroke for Auto Switch Mounting [mm]

Auto switch model	Number of auto switches	[mm]	
		ø16	ø32
D-M9□V	1		5
	2		5
D-M9□	1	5*1	5
	2		10
D-M9□W	1	5*2	
	2		10
D-M9□WV D-M9□AV	1	5*2	
	2		10
D-M9□A	1	5*2	
	2		10*2
D-A9□	1	5*1	5
	2	10*1	10
D-A9□V	1		5
	2		10

\*1 Confirm that it is possible to secure the minimum bending radius of 10 mm of the auto switch lead wire before use.

\*2 Confirm that it is possible to securely set the auto switch(es) within the range of indicator green light ON range before use.  
For the in-line entry type, also consider \*1 shown above.

### Operating Range [mm]

Auto switch model	Bore size [mm]	
	16	32
D-M9□/M9□V D-M9□W/M9□WV D-M9□A/M9□AV	3.5	5.5
D-A9□/A9□V	7	9.5

\* Values which include hysteresis are for reference purposes only. They are not a guarantee (assuming approximately ±30% dispersion) and may change substantially depending on the ambient environment.

### Auto Switch Mounting

Applicable auto switches	D-M9□/M9□V D-M9□W/M9□WV D-M9□A/M9□AV D-A9□/A9□V	
Bore size [mm]	ø16, ø32	
Auto switch tightening torque	[N·m]	
	Auto switch model	Tightening torque
	D-M9□(V) D-M9□W(V) D-A93	0.05 to 0.15
	D-M9□A(V) D-A9□(V) (Excludes the D-A93)	0.10 to 0.20



# Prior to Use

## Auto Switch Connections and Examples

### Sink Input Specifications

#### 3-wire, NPN

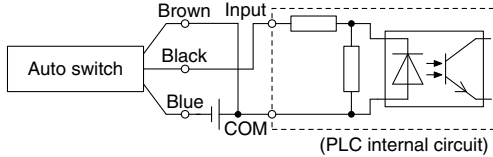

#### 2-wire

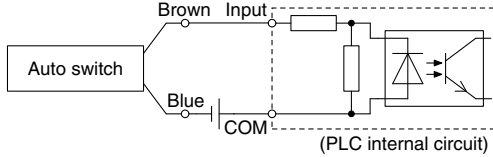

### Source Input Specifications

#### 3-wire, PNP

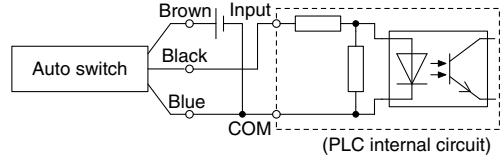

#### 2-wire

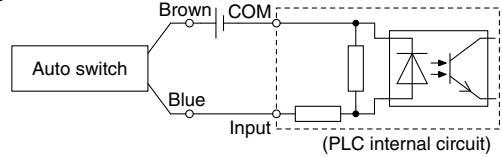

Connect according to the applicable PLC input specifications, as the connection method will vary depending on the PLC input specifications.

### Examples of AND (Series) and OR (Parallel) Connections

\* When using solid state auto switches, ensure the application is set up so the signals for the first 50 ms are invalid. Depending on the operating environment, the product may not operate properly.

#### 3-wire AND connection for NPN output (Using relays)

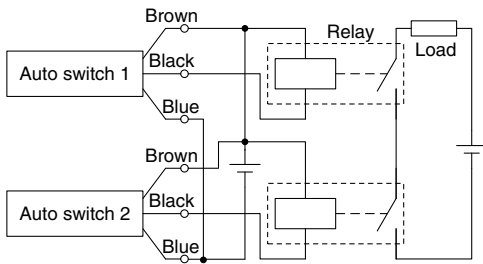

#### (Performed with auto switches only)

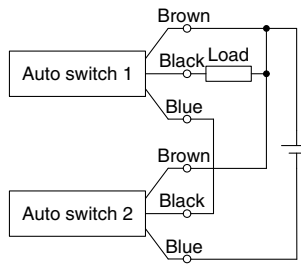

#### 3-wire OR connection for NPN output

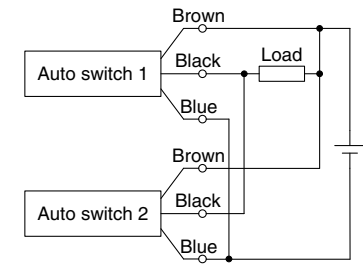

#### 3-wire AND connection for PNP output (Using relays)

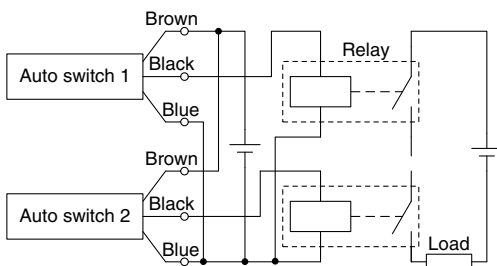

#### (Performed with auto switches only)

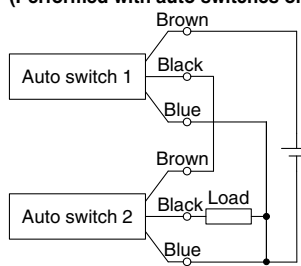

#### 3-wire OR connection for PNP output

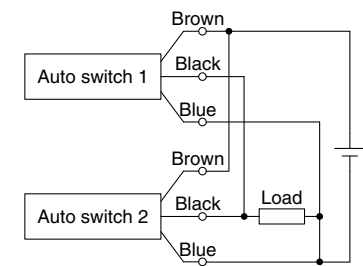

#### 2-wire AND connection

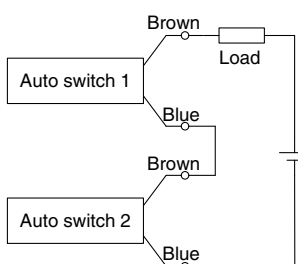

When two auto switches are connected in series, a load may malfunction because the load voltage will decline when in the ON state. The indicator lights will light up when both of the auto switches are in the ON state. Auto switches with a load voltage less than 20 V cannot be used. Please contact SMC if using AND connection for a heat-resistant solid state auto switch or a trimmer switch.

Example) Load voltage at ON  
 Power supply voltage: 24 VDC  
 Internal voltage drop: 4 V  
 Load voltage at ON = Power supply voltage –  
 Internal voltage drop x 2 pcs.  
 = 24 V – 4 V x 2 pcs.  
 = 16 V

#### 2-wire OR connection

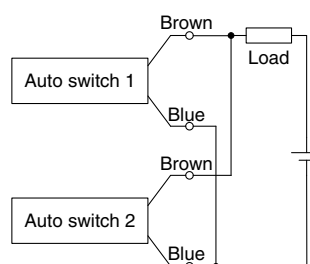

(Solid state)  
 When two auto switches are connected in parallel, malfunction may occur because the load voltage will increase when in the OFF state.

(Reed)  
 Because there is no current leakage, the load voltage will not increase when turned OFF. However, depending on the number of auto switches in the ON state, the indicator lights may sometimes grow dim or not light up, due to the dispersion and reduction of the current flowing to the auto switches.

Example) Load voltage at OFF  
 Leakage current: 1 mA  
 Load impedance: 3 kΩ  
 Load voltage at OFF = Leakage current x 2 pcs. x  
 Load impedance  
 = 1 mA x 2 pcs. x 3 kΩ  
 = 6 V



# MGPK Series Specific Product Precautions 1

Be sure to read this before handling the products. Refer to the back cover for safety instructions. For actuator and auto switch precautions, refer to the “Handling Precautions for SMC Products” and the “Operation Manual” on the SMC website: <https://www.smcworld.com>

## Mounting

### Warning

#### 1. Never place your hands or fingers between the plate and the body.

Be very careful to prevent your hands or fingers from getting caught in the gap between the cylinder body and the plate when air is applied.

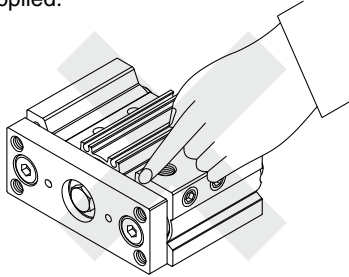

### Caution

#### 1. Use cylinders within the piston speed range.

An orifice is set for this cylinder, but the piston speed may exceed the operating range if the speed controller is not used. If the cylinder is used outside the operating speed range, it may cause damage to the cylinder and shorten the service life. Adjust the speed by installing the speed controller and use the cylinder within the limited range.

#### 2. Pay attention to the operating speed when the product is mounted vertically.

When using the product in the vertical direction, if the load factor is large, the operating speed can be faster than the control speed of the speed controller (i.e. quick extension). In such cases, it is recommended to use a dual speed controller.

#### 3. Do not scratch or gouge the sliding portion of the piston rod and the guide rod.

Damaged seals etc., will result in leakage or malfunction.

#### 4. Do not dent or scratch the mounting surface of the body and the plate.

This may cause a decrease in the flatness of the mounting surface, which will cause an increase in sliding resistance.

#### 5. Make sure that the cylinder mounting surface has a flatness of 0.05 mm or less.

If the flatness of the workpieces and brackets mounted on the plate is not appropriate, sliding resistance may increase.

If it is difficult to maintain a flatness of 0.05 mm or less, put a thin shim ring (provided by the customer) between the plate and the workpiece mounting surface to prevent the sliding resistance from increasing.

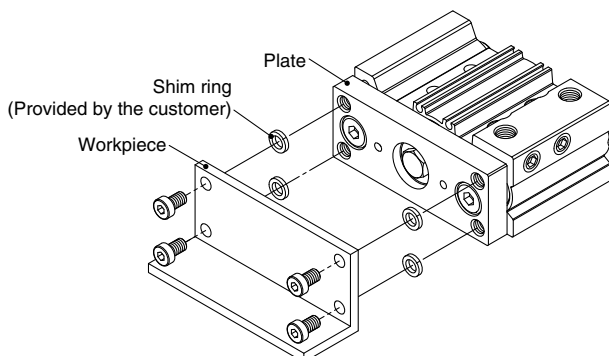

## Mounting

### Caution

#### 6. Cylinder bottom

Since the guide rods project from the bottom of the cylinder at the end of the retraction stroke, provide bypass ports in the mounting surface, as well as holes for the hexagon socket head mounting screws, when the cylinder is mounted from the bottom.

Furthermore, when subjected to impact in use as a stopper, etc., screw the mounting bolts in to a depth of 2d or more.

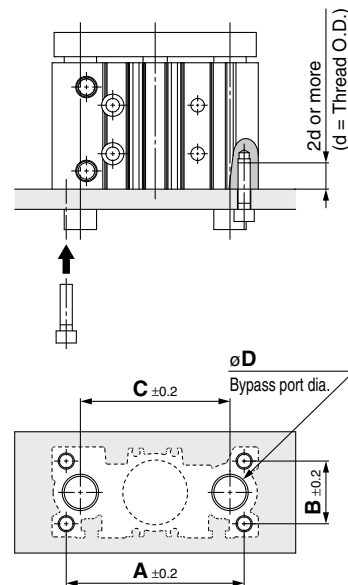

Bore size [mm]	[mm]			
	A	B	C	D
16	51	20	42	10
32	88	31	74	18



# MGPK Series Specific Product Precautions 2

Be sure to read this before handling the products. Refer to the back cover for safety instructions. For actuator and auto switch precautions, refer to the “Handling Precautions for SMC Products” and the “Operation Manual” on the SMC website: <https://www.smcworld.com>

## Piping

### ⚠ Caution

Depending on the operating condition, change the position of plugs for the piping port. Refer to the following for the proper tightening torque of the plug.

#### 1. M5

After tightening by hand, tighten an additional 1/6 to 1/4 turn with a tightening tool.

#### 2. Tapered thread for Rc port (MGPK□32) and NPT port (MGPK□32TN)

Tighten with proper tightening torque below. Also, use sealant tape on the plug. With regard to the sunk dimension of a plug (“a” dimension in the drawing), use the stipulated figures as a guide and confirm the air leakage before operation.

\* If plugs on the top mounting port are tightened with more than the proper tightening torque, they will be screwed too deeply and the air passage will be constricted, resulting in limited cylinder speed.

Connection thread (plug) size	Proper tightening torque [N·m]	a dimension
1/8	7 to 9	0.5 mm or less

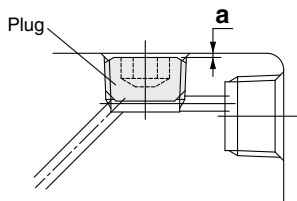

#### 3. Parallel pipe thread for G port (MGPK□32TF)

Screw in the plug to the surface of the body (“a” dimension in the drawing) by checking visually instead of using the tightening torque shown in the table.

## Allowable Kinetic Energy

### ⚠ Caution

Load mass and a maximum speed must be within the ranges shown below.

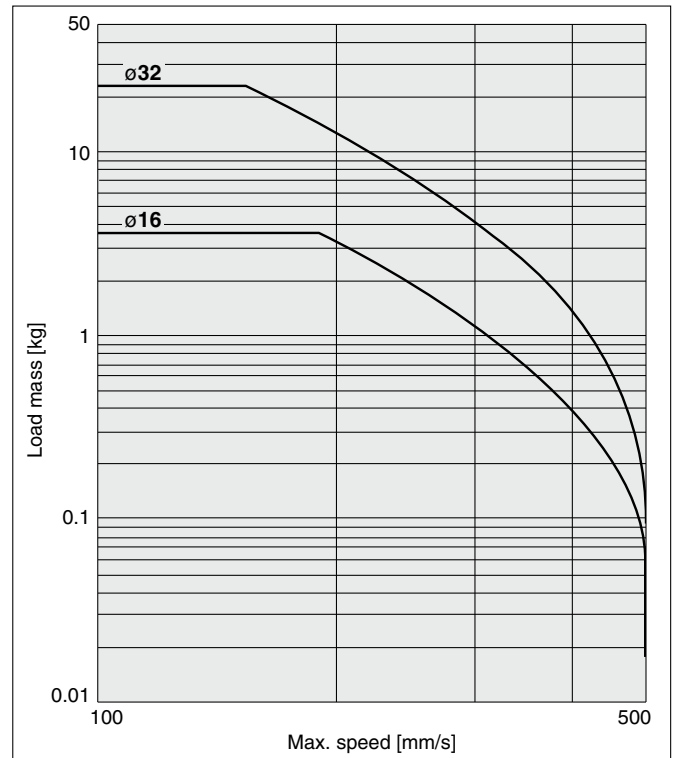

## Safety Instructions

These safety instructions are intended to prevent hazardous situations and/or equipment damage. These instructions indicate the level of potential hazard with the labels of “**Caution**,” “**Warning**” or “**Danger**.” They are all important notes for safety and must be followed in addition to International Standards (ISO/IEC)\*1), and other safety regulations.

 **Caution:** **Caution** indicates a hazard with a low level of risk which, if not avoided, could result in minor or moderate injury.

 **Warning:** **Warning** indicates a hazard with a medium level of risk which, if not avoided, could result in death or serious injury.

 **Danger:** **Danger** indicates a hazard with a high level of risk which, if not avoided, will result in death or serious injury.

\*1) ISO 4414: Pneumatic fluid power – General rules relating to systems.  
ISO 4413: Hydraulic fluid power – General rules relating to systems.  
IEC 60204-1: Safety of machinery – Electrical equipment of machines.  
(Part 1: General requirements)  
ISO 10218-1: Manipulating industrial robots – Safety.  
etc.

### Warning

#### 1. The compatibility of the product is the responsibility of the person who designs the equipment or decides its specifications.

Since the product specified here is used under various operating conditions, its compatibility with specific equipment must be decided by the person who designs the equipment or decides its specifications based on necessary analysis and test results. The expected performance and safety assurance of the equipment will be the responsibility of the person who has determined its compatibility with the product. This person should also continuously review all specifications of the product referring to its latest catalog information, with a view to giving due consideration to any possibility of equipment failure when configuring the equipment.

#### 2. Only personnel with appropriate training should operate machinery and equipment.

The product specified here may become unsafe if handled incorrectly. The assembly, operation and maintenance of machines or equipment including our products must be performed by an operator who is appropriately trained and experienced.

#### 3. Do not service or attempt to remove product and machinery/equipment until safety is confirmed.

1. The inspection and maintenance of machinery/equipment should only be performed after measures to prevent falling or runaway of the driven objects have been confirmed.
2. When the product is to be removed, confirm that the safety measures as mentioned above are implemented and the power from any appropriate source is cut, and read and understand the specific product precautions of all relevant products carefully.
3. Before machinery/equipment is restarted, take measures to prevent unexpected operation and malfunction.

#### 4. Contact SMC beforehand and take special consideration of safety measures if the product is to be used in any of the following conditions.

1. Conditions and environments outside of the given specifications, or use outdoors or in a place exposed to direct sunlight.
2. Installation on equipment in conjunction with atomic energy, railways, air navigation, space, shipping, vehicles, military, medical treatment, combustion and recreation, or equipment in contact with food and beverages, emergency stop circuits, clutch and brake circuits in press applications, safety equipment or other applications unsuitable for the standard specifications described in the product catalog.
3. An application which could have negative effects on people, property, or animals requiring special safety analysis.
4. Use in an interlock circuit, which requires the provision of double interlock for possible failure by using a mechanical protective function, and periodical checks to confirm proper operation.

### Caution

#### 1. The product is provided for use in manufacturing industries.

The product herein described is basically provided for peaceful use in manufacturing industries.  
If considering using the product in other industries, consult SMC beforehand and exchange specifications or a contract if necessary.  
If anything is unclear, contact your nearest sales branch.

### Limited warranty and Disclaimer/ Compliance Requirements

The product used is subject to the following “Limited warranty and Disclaimer” and “Compliance Requirements”.

Read and accept them before using the product.

#### Limited warranty and Disclaimer

1. The warranty period of the product is 1 year in service or 1.5 years after the product is delivered, whichever is first.\*2)  
Also, the product may have specified durability, running distance or replacement parts. Please consult your nearest sales branch.
2. For any failure or damage reported within the warranty period which is clearly our responsibility, a replacement product or necessary parts will be provided.  
This limited warranty applies only to our product independently, and not to any other damage incurred due to the failure of the product.
3. Prior to using SMC products, please read and understand the warranty terms and disclaimers noted in the specified catalog for the particular products.

##### \*2) Vacuum pads are excluded from this 1 year warranty.

A vacuum pad is a consumable part, so it is warranted for a year after it is delivered.  
Also, even within the warranty period, the wear of a product due to the use of the vacuum pad or failure due to the deterioration of rubber material are not covered by the limited warranty.

#### Compliance Requirements

1. The use of SMC products with production equipment for the manufacture of weapons of mass destruction (WMD) or any other weapon is strictly prohibited.
2. The exports of SMC products or technology from one country to another are governed by the relevant security laws and regulations of the countries involved in the transaction. Prior to the shipment of a SMC product to another country, assure that all local rules governing that export are known and followed.

### Caution

#### SMC products are not intended for use as instruments for legal metrology.

Measurement instruments that SMC manufactures or sells have not been qualified by type approval tests relevant to the metrology (measurement) laws of each country. Therefore, SMC products cannot be used for business or certification ordained by the metrology (measurement) laws of each country.

## Safety Instructions

Be sure to read the “Handling Precautions for SMC Products” (M-E03-3) and “Operation Manual” before use.