

Guide Table

MGF Series

ø40, ø63, ø100

Low-profile compact cylinder utilizes a large concentric guiding sleeve to provide excellent eccentric load resistance.

■ Mounting height greatly reduced

Low-profile cylinder enables compact machine design.

Mounting height
Reduction by 15 to 20%
(Compared to SMC MGQ series)

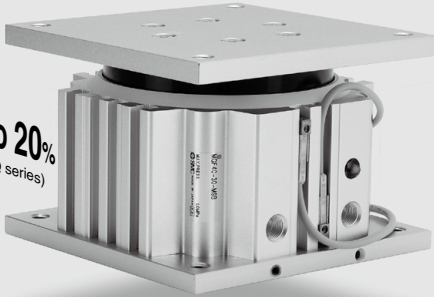

■ Built-in non-rotating mechanism

Internal guide pin prevents rotation.

Non-rotating accuracy

Bore size (mm)	Non-rotating accuracy (f)
40	± 0.08°
63	± 0.06°
100	± 0.05°

■ Series Variations

Model	Bore size (mm)	Standard stroke (mm)			
		30	50	75	100
MGF 40	40	●	●	●	●
MGF 63	63	●	●	●	●
MGF100	100	●	●	●	●

■ Built-in T-slots

T-slots are provided on 3 faces of the body (except port face), allowing mounting for various brackets. (Not suitable for mounting the cylinder itself.)

■ Auto switches can be mounted on 4 lateral faces of the body.

■ Large diameter guide (Eccentric load resistant)

A large diameter guide rod enables the cylinder to handle eccentric loads applied from any direction within a 360° angle.

Allowable moment

Bore size (mm)	Allowable moment (N·m)
40	10
63	40
100	110

* Values are at a cylinder speed of 100 mm/s.

■ Can be mounted from two directions

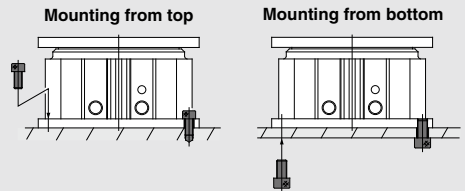

■ Application examples

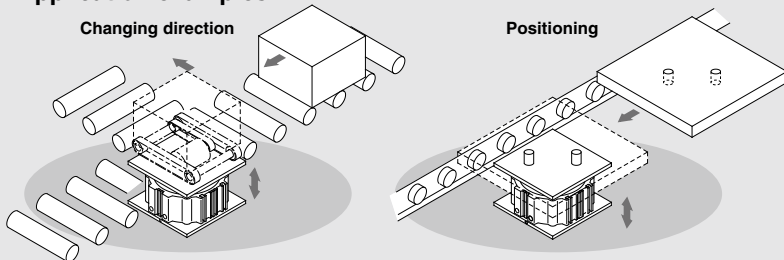

MGJ

JMGP

MGP

MGPW

MGQ

MGG

MGC

MGF

MGZ

MGT

D-□

-X□

MGF Series Model Selection

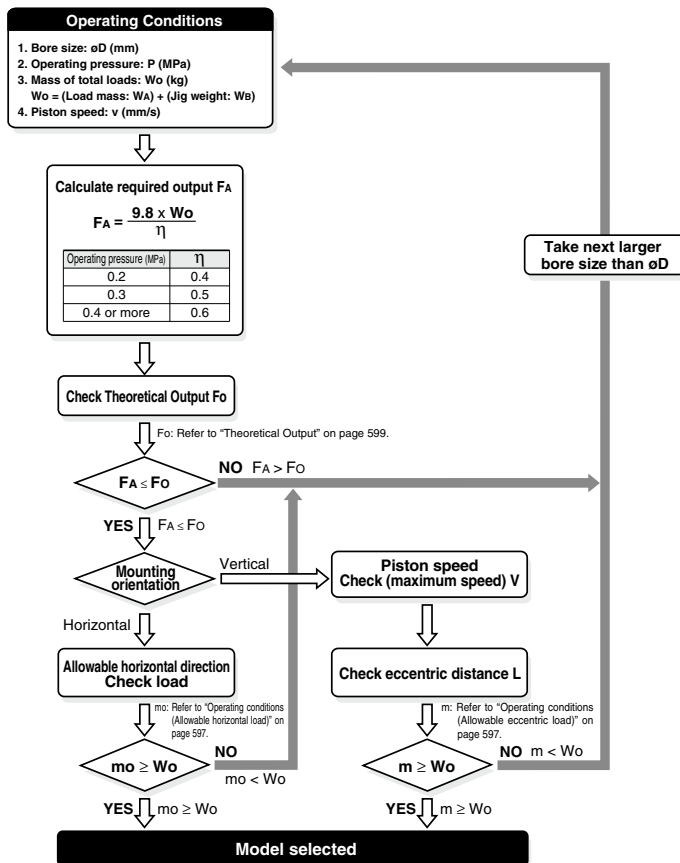

Allowable rotational torque

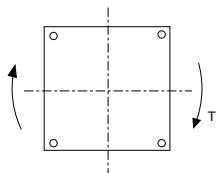

T (N · m)

Bore size (mm)	Stroke (mm)			
	30	50	75	100
40	7	5	4	3
63	22	16	12	10
100	30	22	17	13

Non-rotating accuracy

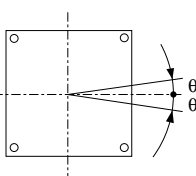

Bore size (mm)	Non-rotating accuracy θ
40	$\pm 0.08^\circ$
63	$\pm 0.06^\circ$
100	$\pm 0.05^\circ$

Note) The value given for the non-rotating accuracy is applicable below the allowable rotational torque. If a greater rotational torque is applied, the non-rotating rod (page 601) bends, exceeding the value of the non-rotating accuracy.

Deflection angle of plate for eccentric load

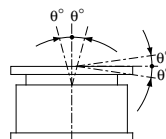

Bore size (mm)	Deflection angle θ°
40	$\pm 0.35^\circ$ or less
63	$\pm 0.3^\circ$ or less
100	

Operating Conditions

Allowable horizontal load

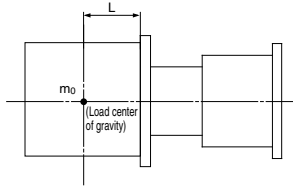

Allowable eccentric load

The maximum value of load which can be applied at an eccentric position at a distance of L (mm) from the cylinder center.

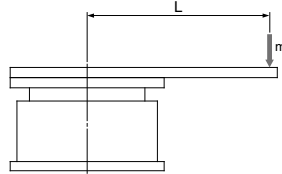

L = 50 mm

Graph ①

L = 100 mm

Graph ②

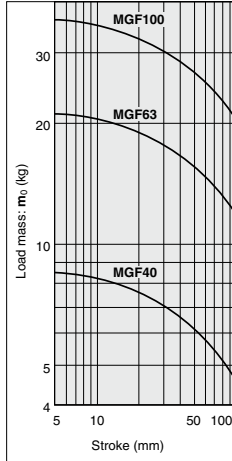
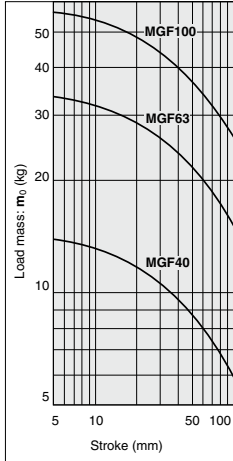

v = 50 mm/s or less

Graph ⑤

v = 100 mm/s or less

Graph ⑥

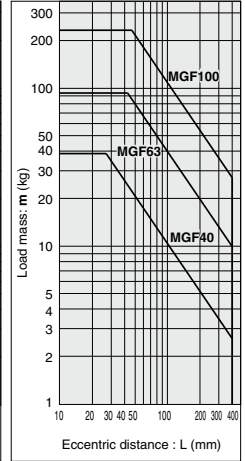
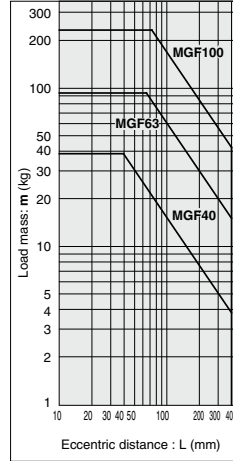

L = 200 mm

Graph ③

L = 300 mm

Graph ④

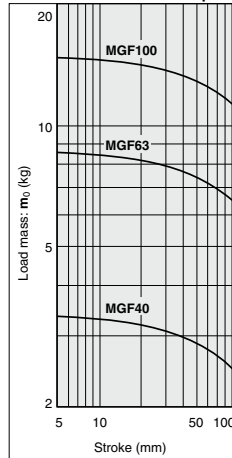
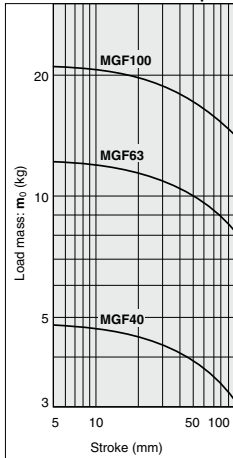

v = 150 mm/s or less

Graph ⑦

v = 200 mm/s or less

Graph ⑧

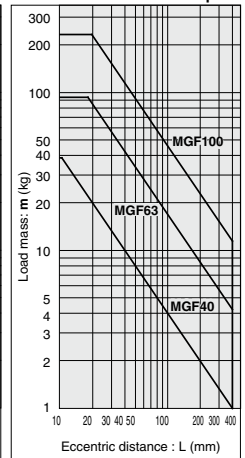
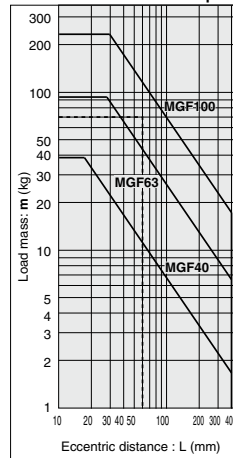

How to read the graph

- When the load mass is 70 kg, eccentric distance is 60 mm, and the maximum speed is 150 mm/s → Select MGF100 from Graph ⑦.
- When MGF63 is operated with a load mass 30 kg and 100 mm eccentric distance → From Graph ⑥, the cylinder can be used at a maximum speed of 100 mm/s or less.

MGJ

JMGP

MGP

MGPW

MGQ

MGG

MGC

MGF

MGZ

MGT

D-□

-X□

Guide Table

MGF Series

Ø40, Ø63, Ø100

How to Order

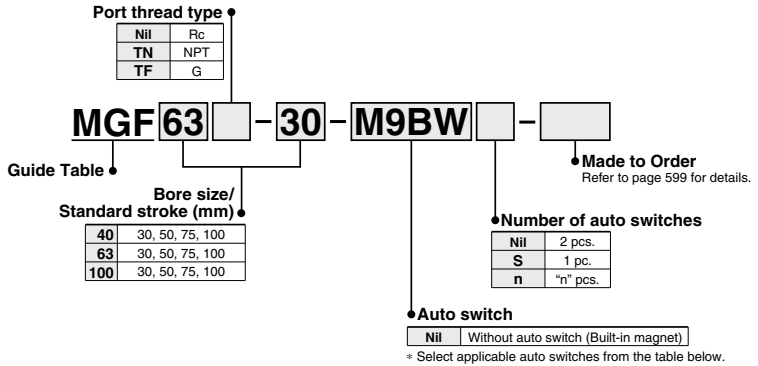

Applicable Auto Switches/Refer to pages 1119 to 1245 for further information on auto switches.

Type	Special function	Electrical entry	Indicator/light	Wiring (Output)	Load voltage		Auto switch model		Lead wire length (m)				Pre-wired connector	Applicable load			
					DC	AC	Perpendicular	In-line	0.5 (Nil)	1 (M)	3 (L)	5 (Z)					
Solid state auto switch	—	Grommet	Yes	3-wire (NPN)	24 V	5 V, 12 V	—	M9NV	M9N	●	●	○	○	IC circuit	Relay, PLC		
				3-wire (PNP)				M9PV	M9P	●	●	○	○				
				2-wire	M9BV	M9B	●	●	○	○	—						
				3-wire (NPN)	M9NWV	M9NW	●	●	○	○	IC circuit						
	Diagnostic indication (2-color indicator)	Grommet	Yes	Yes	3-wire (PNP)	24 V	5 V, 12 V	—	M9PWV	M9PW	●	●	○	○	IC circuit	Relay, PLC	
					2-wire				M9BWV	M9BW	●	●	○	○			—
					3-wire (NPN)	M9NAV**	M9NA**	○	○	●	○	IC circuit					
					3-wire (PNP)	M9PAV**	M9PA**	○	○	●	○	IC circuit					
Water resistant (2-color indicator)	Grommet	Yes	Yes	2-wire	24 V	12 V	—	M9BAV**	M9BA**	○	○	●	○	—	—		
				3-wire (NPN equivalent)				—	5 V	—	Z76	●	—			●	—
				2-wire	24 V	12 V	100 V	—	Z73	●	—	●	—			—	Relay, PLC
				2-wire	24 V	12 V	100 V or less	—	Z80	●	—	●	—			—	IC circuit

** Water resistant type auto switches can be mounted on the above models, but in such case SMC cannot guarantee water resistance. Consult with SMC regarding water resistant types with the above model numbers.

* Lead wire length symbols: 0.5 m Nil (Example) M9NW
 1 m M (Example) M9NWM
 3 m L (Example) M9NWL
 5 m Z (Example) M9NWZ

* Solid state auto switches marked with "○" are produced upon receipt of order.
 * ○ : D-A9□/A9□V cannot be mounted.

* Since there are other applicable auto switches than listed, refer to page 605 for details.
 * For details about auto switches with pre-wired connector, refer to pages 1192 and 1193.
 * Auto switches are shipped together (not assembled).



Made to Order Specifications
[Click here for details](#)

Symbol	Specifications
-XC79	Machining tapped hole, drilled hole and pin hole additionally

Specifications

Bore size (mm)	40	63	100
Action	Double acting		
Fluid	Air		
Proof pressure	1.5 MPa		
Maximum operating pressure	1.0 MPa		
Minimum operating pressure	0.1 MPa		
Ambient and fluid temperature	-10 to 60°C		
Piston speed	20 to 200 mm/s		
Cushion	Rubber bumper on both ends		
Lubrication	Non-lube		
Stroke length tolerance	$^{+1.0}_0$ mm		

Standard Stroke

Model	Standard stroke (mm)	Intermediate stroke
MGF 40	30, 50, 75, 100	As for the intermediate strokes (in 5 stroke increments) other than the standard strokes at left are manufactured by means of installing a spacer with the width of 5, 10, 15, 20, 25 mm. Example) In the case an MGF63-15 specification is required, a spacer of 15 mm is installed in the MGF63-30. The full length dimension when the cylinder is retracted is the same as that of 30 mm stroke.
MGF 63		
MGF100		

Theoretical Output

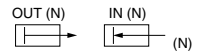

Bore size (mm)	Rod size (mm)	Operating direction	Piston area (mm ²)	Operating pressure (MPa)									
				0.2	0.3	0.4	0.5	0.6	0.7	0.8	0.9	1.0	
40	25	OUT	1256	251	376	502	628	753	879	1004	1130	1256	
		IN	765	153	229	306	382	459	535	612	688	765	
63	36	OUT	3117	623	935	1246	1558	1870	2182	2493	2805	3117	
		IN	2099	419	629	839	1049	1259	1469	1679	1889	2099	
100	36	OUT	7853	1570	2356	3141	3926	4711	5497	6282	7067	7853	
		IN	6835	1367	2050	2734	3417	4101	4784	5468	6151	6835	

Note) Theoretical output (N) = Pressure (MPa) x Piston area (mm²)

Weight

Model	Bore size (mm)	Standard stroke (mm)			
		30	50	75	100
MGF 40	40	2.0	2.4	3.0	3.6
MGF 63	63	4.1	4.8	5.7	6.6
MGF100	100	6.2	7.2	8.4	9.6

MGJ

JMGP

MGP

MGPW

MGQ

MGG

MGC

MGF

MGZ

MGT

D-□

-X□

MGF Series

Clean Series

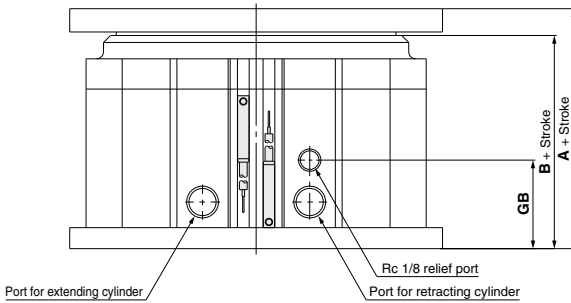
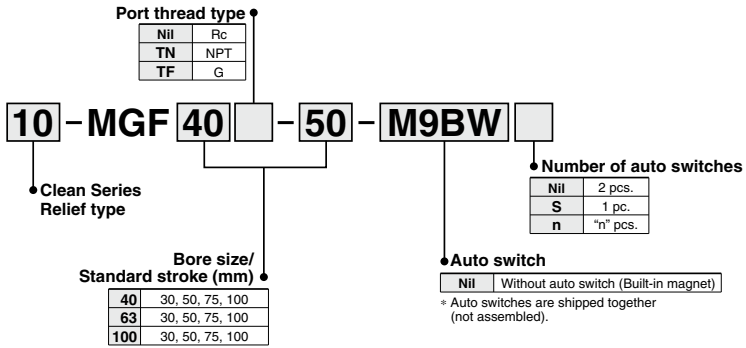

Dimensions

Bore size (mm)	A	B	GB
40	58	48.5	36.5
63	73	61.5	38
100	78	66.5	38

Dimensions other than the above are the same as standard products.

Refer to "Pneumatic Clean Series" catalog (CAT.E02-23) for details.

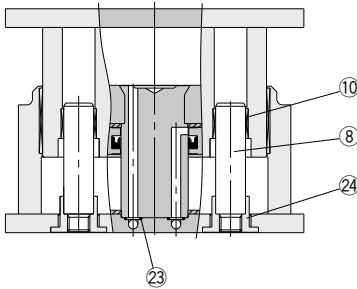
Construction

When the cylinder is extended

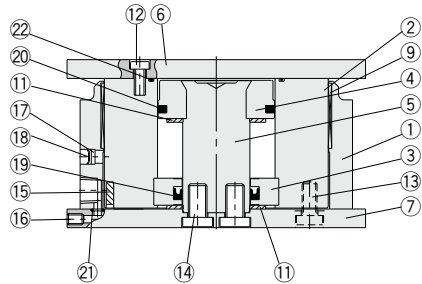

When the cylinder is retracted

Component Parts

No.	Description	Material	Note
1	Body	Aluminum alloy	Clear anodized
2	Tube	Aluminum alloy	Black hard anodized
3	Rod cover	Aluminum alloy	Black hard anodized
4	Piston	Aluminum alloy	Chromated
5	Piston rod	Carbon steel	Electroless nickel plated
6	Plate	Aluminum alloy	Anodized
7	End plate	Aluminum alloy	Anodized
8	Non-rotating rod	Stainless steel	Hard chrome plated
9	Bushing	Resin	
10	Bushing (For non-rotating rod)	Bearing alloy	
11	Bumper	Urethane	
12	Hexagon socket head cap screw A	Carbon steel	Nickel plated

Component Parts

No.	Description	Material	Note
13	Hexagon socket head cap screw B	Carbon steel	Nickel plated
14	Hexagon socket head cap screw C	Carbon steel	Nickel plated
15	Magnet	—	
16	Plug	Carbon steel	
17	Element	Resin	
18	Retaining ring	Spring steel	
19	Rod seal	NBR	
20	Piston seal	NBR	
21	O-ring A	NBR	
22	O-ring B	NBR	
23	O-ring C	NBR	
24	Reinforcement ring	Carbon steel	Electroless nickel plated

Replacement Parts: Seal Kit

Bore size (mm)	Kit no.	Contents
40	MGF40-PS	Items 19 to 23 from the table above.
63	MGF63-PS	
100	MGF100-PS	

- * Seal kit is not compatible with the clean series.
- * Seal kit includes 19 to 23. Order the seal kit based on each bore size.
- * Since the seal kit does not include a grease pack, order it separately.
- Grease pack part no.:** GR-L-010 (10g)

MGJ

JMGP

MGP

MGPW

MGQ

MGG

MGC

MGF

MGZ

MGT

D-□

-X□

MGF Series

Dimensions: $\phi 40$

MGF40

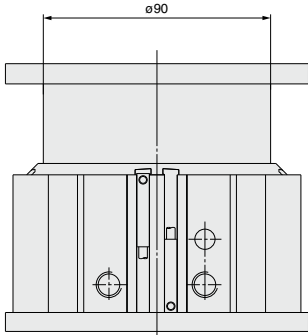

When the cylinder is extended

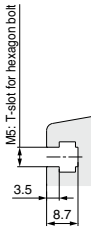
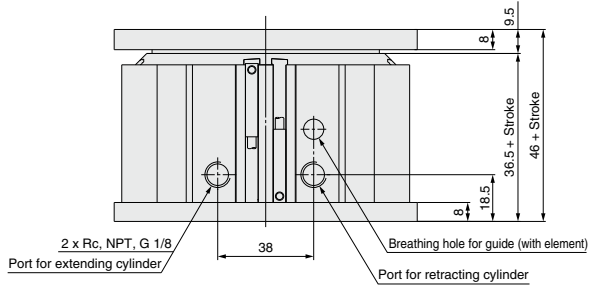
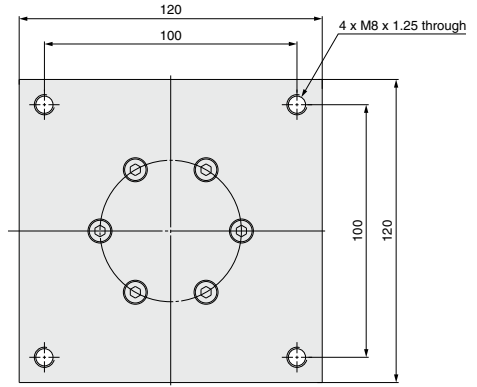

6 x K (6 places)

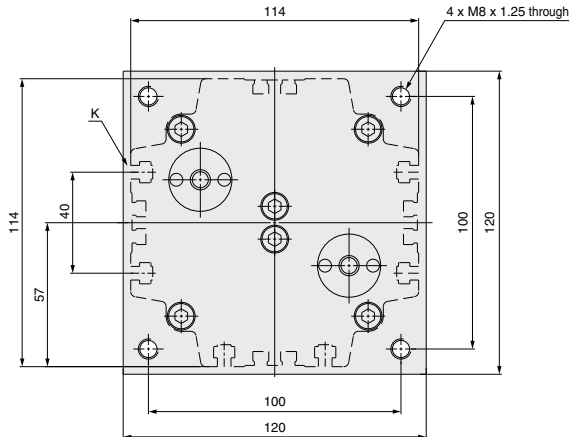

ø63

MGF63

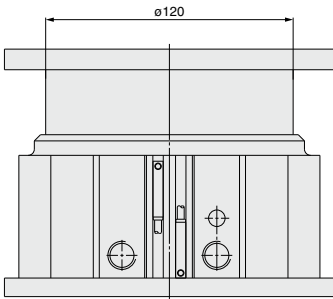

When the cylinder is extended

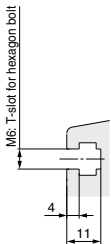

6 x K (6 places)

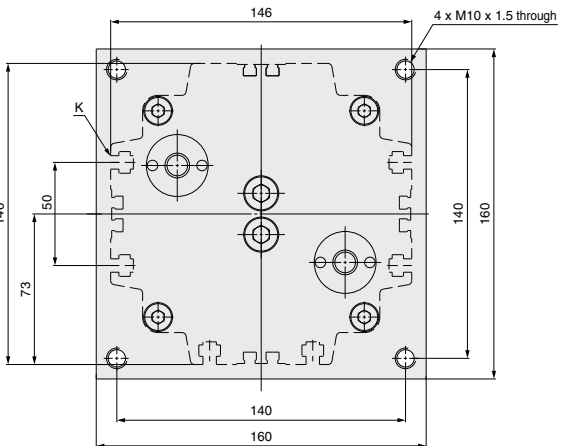
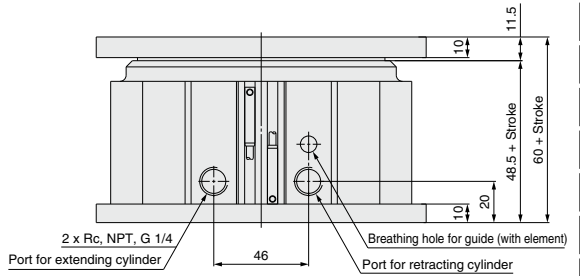
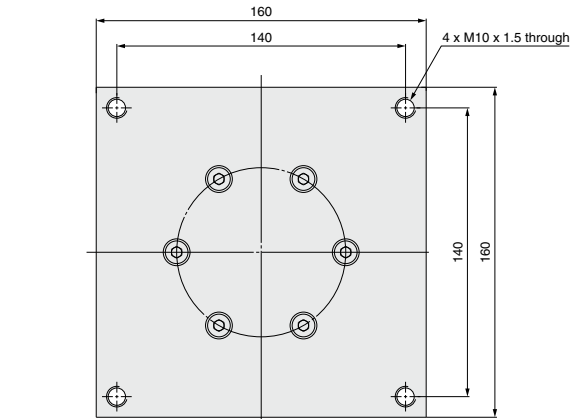

- MGJ**
- JMP**
- MGP**
- MGPW**
- MGQ**
- MGG**
- MGC**
- MGF**
- MGZ**
- MGT**

- D-□**
- X□**

MGF Series

Dimensions: $\phi 100$

MGF100

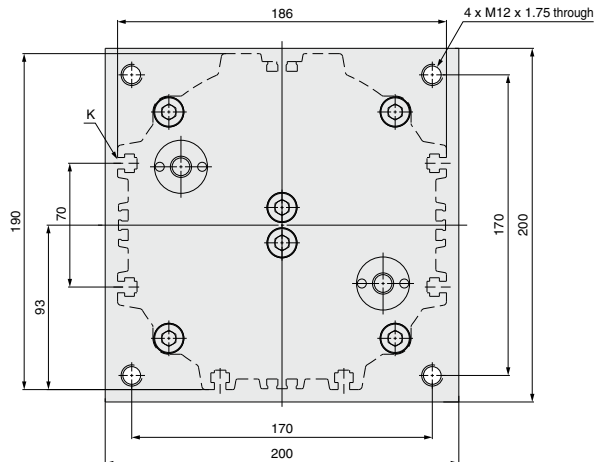
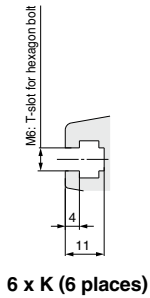
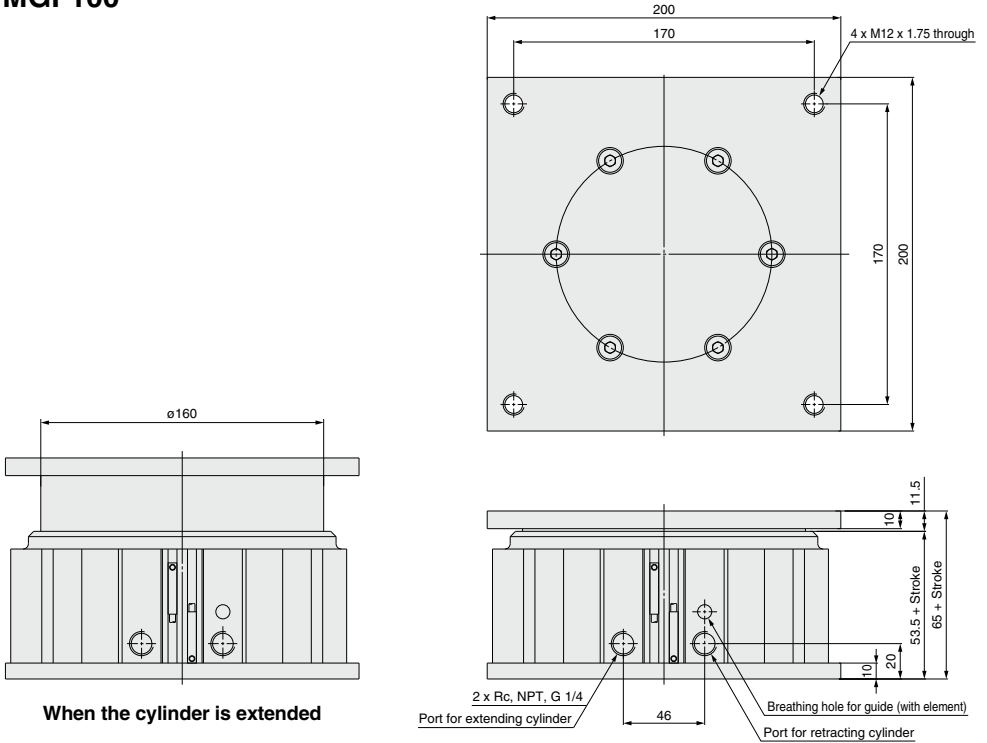

Auto Switch Mounting

Minimum Auto Switch Mounting Stroke

No. of auto switches mounted	Applicable auto switch model								
	D-M9□V	D-M9□WV D-M9□AV	D-M9□ D-M9□W	D-M9□A	D-Z7□ D-Z8□	D-Y69□ D-Y7PV	D-Y59□ D-Y7P	D-Y7□WV	D-Y7□W D-Y7BA
1 pc.	5	10	15	20	10	5	10	15	20
2 pcs.	10	10	20	25	15	10	10	15	20

Auto Switch Proper Mounting Position (Detection at Stroke End)

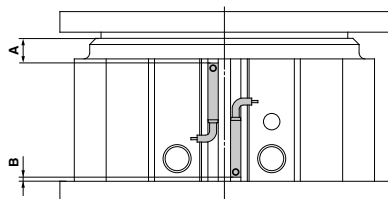

Auto Switch Proper Mounting Position

Auto switch model	Bore size (mm)			
	A		B	
D-M9□ D-M9□V D-M9□W D-M9□WV D-M9□A D-M9□AV	A		B	
D-Z7□/Z80 D-Y59□/Y69□ D-Y7P/Y7PV D-Y7□W/Y7□WV D-Y7BA	A		B	
40	9	4.5	4	0
63	19.5	4	14.5	0
100	24.5	4	19.5	0

Dimensions above denote the standard strokes.
Adjustment on A dimension is required for intermediate strokes.
Note) Adjust the auto switch after confirming the operating conditions in the actual setting.

Operating Range

Auto switch model	Bore size (mm)		
	40	63	100
D-M9□/M9□V D-M9□W/M9□WV D-M9□A/M9□AV	6	6.5	6
D-Z7□/Z80	10	10	10
D-Y59□/Y69□ D-Y7P/Y7PV D-Y7□W/Y7□WV D-Y7BA	6	6	6

* Since this is a guideline including hysteresis, not meant to be guaranteed. (Assuming approximately ±30% dispersion)
There may be the case it will vary substantially depending on an ambient environment.

Auto Switch Mounting Bracket: Part No.

Auto switch model	Bore size (mm)
	ø40, ø63, ø100
D-M9□/M9□V D-M9□W/M9□WV D-M9□A/M9□AV	BMG2-012

D-M9□(V)/M9□W(V)/M9□A(V)

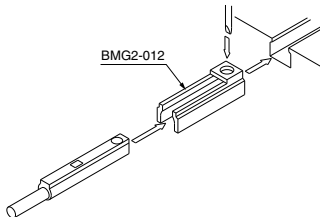

Other than the applicable auto switches listed in "How to Order", the following auto switches can be mounted. For detailed specifications, refer to pages 1119 to 1245.

Auto switch type	Model	Electrical entry (Fetching direction)	Features
Solid state	D-Y69A, Y69B, Y7PV	Grommet (Perpendicular)	—
	D-Y7NWV, Y7PWV, Y7BWV		Diagnostic indication (2-color indicator)
	D-Y59A, Y59B, Y7P	Grommet (In-line)	—
	D-Y7NW, Y7PW, Y7BW		Diagnostic indication (2-color indicator)

* For solid state auto switches, auto switches with a pre-wired connector are also available. Refer to pages 1192 and 1193 for details.
* Normally closed (NC = b contact), solid state auto switch (D-F9G/F9H/Y7G/Y7H type) are also available. For details, refer to pages 1137 and 1139.

MGJ

JMP

MGP

MGPW

MGQ

MGG

MGC

MGF

MGZ

MGT

D-□

-X□



MGF Series

Specific Product Precautions

Be sure to read this before handling the products.

Refer to back page 50 for Safety Instructions and pages 3 to 12 for Actuator and Auto Switch Precautions.

Selection

⚠ Caution

① **Operate loads within the range of the operating limits.**

Select a model taking into consideration the allowable horizontal loads, rotational torque and eccentric loads that will apply. When used in excess of the applicable limit, eccentric loads applied to the tube guide will cause wear of the guide, increase the guide's deviation range, cause stress cracks and breaks on the mounting bolts, and decrease the life of the cylinder.

② **Do not allow any dents, scratches, or other damage on the mounting faces of either the plate or end plate.**

The flatness of the mounting face may deteriorate, the guide's deviation range may increase and the sliding resistance may become greater.

③ **Do not allow hands or fingers near the cylinder during its operation.**

Your fingers may be caught between the body and the plate. If you need to come near the cylinder during its operation, install a cover on the cylinder.

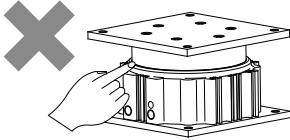

④ **Do not bring objects that are sensitive to magnetism near the cylinder.**

There is a magnetic built into the cylinder. Do not bring magnetic disks, cards, or tapes near the cylinder. Data may be lost.

⑤ **If the cylinder is operated vertically with heavy loads, measures must be taken to prevent rapid advancement of the piston rod when starting to operate in the downward direction.**

If the cylinder is operated vertically with heavy loads at the same pressure for both upward and downward directions, the starting speed in the downward direction may be higher than the speed controlled with a speed controller. In such cases, use a dual pressure control circuit as an pneumatic circuit.

Example)

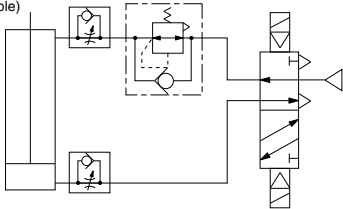

⑥ **Avoid use in environments where a cylinder will come in contact with coolants, cutting oil, water, adhesive matter, or dust, etc. Also avoid operation with compressed air that contains drain or foreign matter, etc.**

Foreign matter or liquids on the cylinder's interior or exterior can wash out the lubricating grease, which can lead to deterioration and damage of bearing sliding parts and seal materials, causing a danger of malfunction.

When operating in locations with exposure to water and oil, or in dusty locations, provide protection such as a cover to prevent direct contact with the cylinder and operate with clean compressed air.

Mounting

⚠ Caution

① **For mounting the cylinder, use screws that meet the appropriate length and tighten within the limits of the maximum tightening torque.**

Mounting from upper side

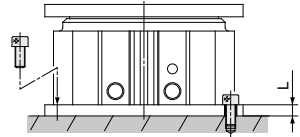

Model	Bolt	Maximum tightening torque (N·m)	L (mm)
MGF 40	M6 x 1	10	8
MGF 63	M8 x 1.25	25	10
MGF100	M10 x 1.5	51	10

Mounting from bottom side

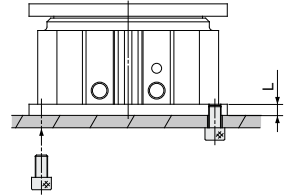

Model	Bolt	Maximum tightening torque (N·m)	L (mm)
MGF 40	M8 x 1.25	18	8
MGF 63	M10 x 1.5	36	10
MGF100	M12 x 1.75	65	10

② **When mounting a workpiece to the cylinder, do so only when the piston is retracted. Also make sure that the rotational torque applied to the cylinder body does not exceed the allowable rotational torque (given on page 596).**

(Otherwise, the excessive rotational torque will damage the non-rotating mechanism and lead to a malfunction.)