

Circulating Fluid Temperature Controller Refrigerated Thermo-chiller

HRZ Series



SEMATECH
S2, S8

SEMI Standard
S2, S8, F47

- Type of circulating fluid: Fluorinated fluids/Ethylene glycol aqueous solution/ Tap water, Deionized water
- Temperature range setting: **-20 to 40°C/20 to 90°C/-20 to 90°C**
- Cooling capacity: **1 kW/2 kW/4 kW/8 kW/10 kW to Max. 15 kW**
- Temperature stability: **±0.1°C**
- Refrigerant: **R404A (HFC)/R134a (HFC)/R410A (HFC)/R448A (HFC/HFO)**

More effective energy-saving is achieved through use of a DC inverter compressor and an inverter pump.

Inverter type

Power consumption

1.1 kWh/h

Facility water

2 L/min



HRS

HRS-R

HRS090

HRS 100/150

HRS200

HRS090

HRSH

HRSE

HRR

HRL

HRZ

HRZD

HRW

HECR

HEC

HEB

HED

Technical Data

Energy Saving

Power consumption:

Max. 40% reduction (SMC comparison)

In addition to the optimum control of the expansion valve by the original controller, by recycling the heat emitted from the facility water, power consumption is dramatically reduced.

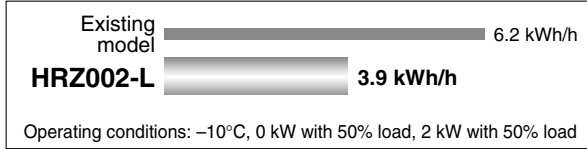

- Reduced running cost
- Contribution to the environmental preservation

Circulating fluid:

Max. 40% reduction (SMC comparison)

Enhanced temperature control technology and the dual tank construction achieved the reduced circulating fluid required for operation.

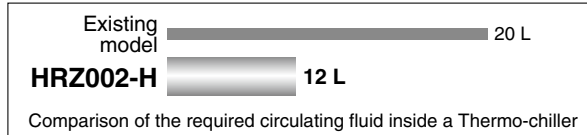

- Reduced initial cost
- Contribution to the environmental preservation

Double Inverter Type

More effective energy-saving is achieved through use of a DC inverter compressor and an inverter pump.

Power consumption:

Max. 82% reduction (SMC comparison)

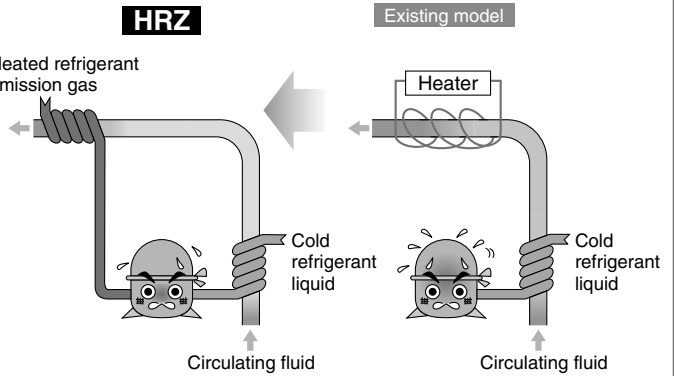
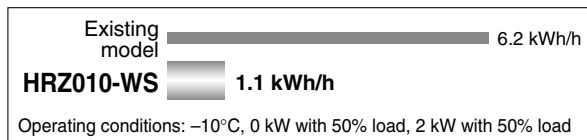

* This illustration is for an image only. For piping systems, refer to "Construction and Principles" on page 349.

Facility water:

Max. 75% reduction (SMC comparison)

Enhanced performance of a heat exchanger, recycle use of the emitted heat and the reduced power consumption achieved the reduced facility water amount.

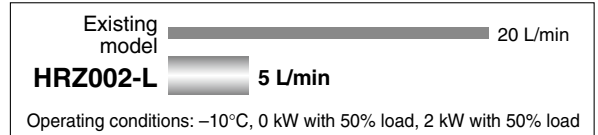

- Reduced facilities investment
- Space saved facility water equipment
- Reduced running cost

Facility water:

Max. 90% reduction (SMC comparison)

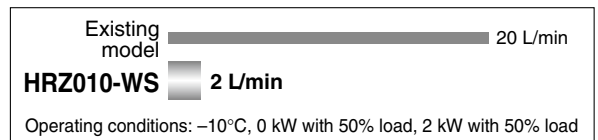

High Performance

Temperature stability: ±0.1°C

(When a load is stable)

Enhanced temperature control technology achieved ±0.1°C temperature stabilities when a load is stable.

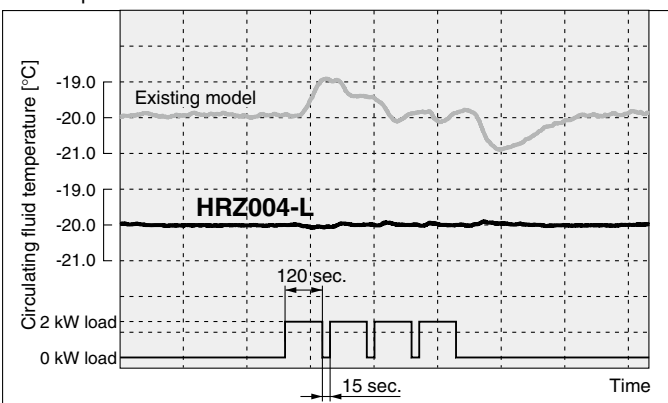

Cooling time: Max. 43% reduction

Special temperature control technology achieved the utmost performance, resulting in the reduced cooling time.

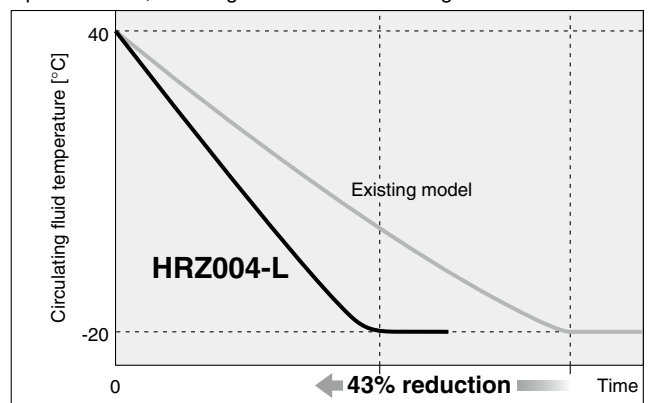

Space Saving

Installation area:

Max. 29% reduction (SMC comparison)

By emitting the heat from the rear side, ventilation slits on the side are unnecessary offering reduced installation space.

Existing model: Body space: W400 mm x D845 mm
Ventilation space: 100 mm

HRZ008-H: Body space: W380 mm x D870 mm
Ventilation space: 0

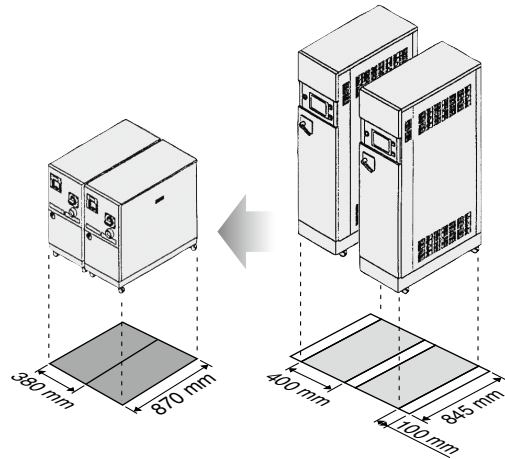

HRZ008-H 0.66 m²

Existing model 0.93 m²

Leakless

All in tank

Housing the pump or heat exchanger inside the tank has eliminated any external leakage of the circulating fluid.

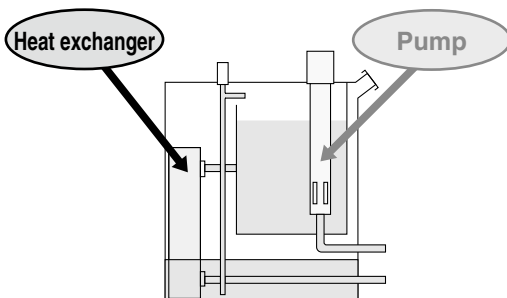

Communications

- Contact input/output signal
- Serial RS-485 communication
- Analog communication (Refer to "Options" on page 373.)
- DeviceNet communication (Refer to "Options" on page 373.)

DeviceNet™

■ Trademark

DeviceNet™ is a trademark of ODVA.

Cooling capacity: Max. 15 kW

Up to 15 kW cooling capacity achieved.

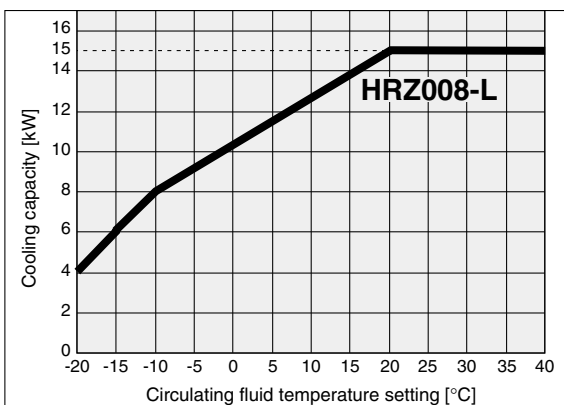

Fluid contact parts adopt the materials compatible for various circulating fluids.

(Stainless steel, EPDM, etc.)

- Fluorinated fluids: **Flourinert™ FC-3283, FC-40**
GALDEN® HT135, HT200
- 60% ethylene glycol aqueous solution
- Deionized water/Tap water

Regarding the fluid other than the above, please contact SMC. Flourinert™ is a trademark of 3M. GALDEN® is a registered trademark of Solvay Solexis, Inc.

Easy Maintenance

● Circulating fluid automatic recovery function (Refer to "Options" on page 374.)

Circulating fluid inside a thermo-chiller tank can be recovered automatically. (Recovery volume: 15 L to 17 L)

- Reduced maintenance time
- Faster operation
- Reduced circulating liquid loss by evaporation or spill

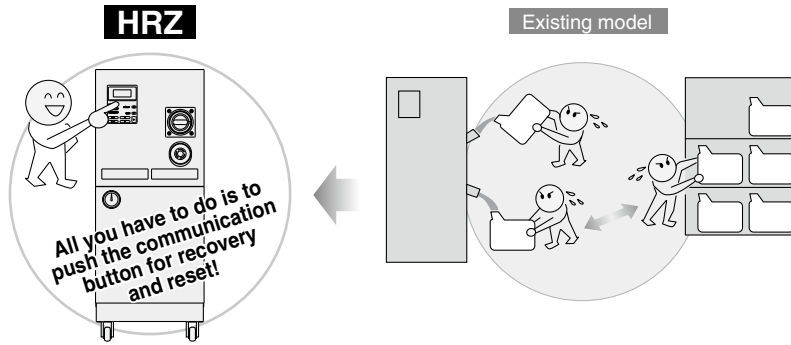

1 Normal operation

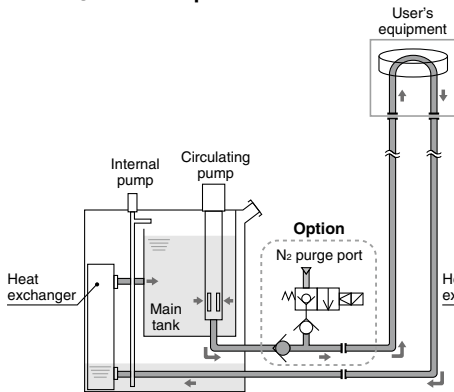

2 Circulating fluid recovery

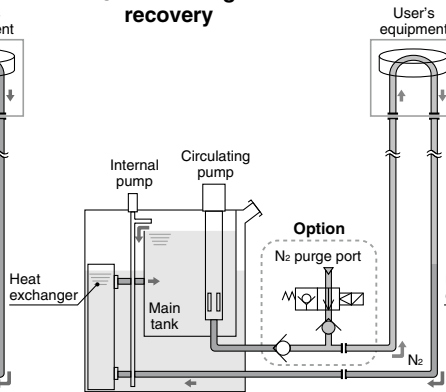

3 Fluid returns to the main tank from the circulating fluid recovery tank.

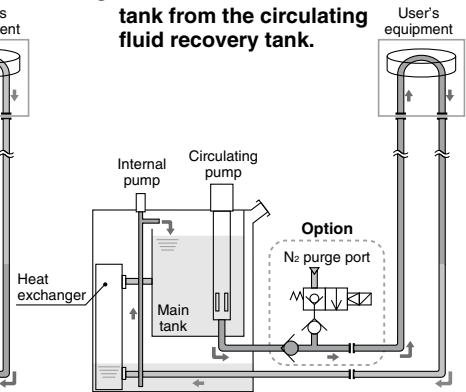

● Circulating fluid electric resistance ratio control function (Refer to "Options" on page 373.)

(DI control kit)

● Easy maintenance

- Checking the electrical component parts accessible from the front side only
- Possible to replace the maintenance parts (such as a pump) without removing the pipings and discharging the circulating fluid.
- Various alarm displays (Refer to page 369.)

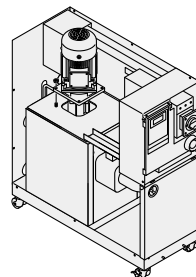
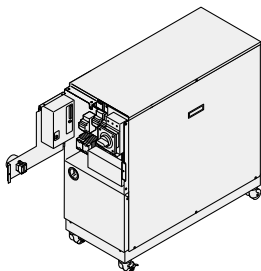

Application Examples

Semiconductor

Example: Temperature control of chamber electrode

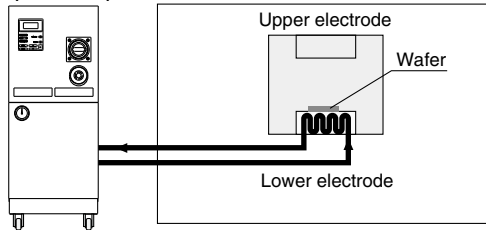

- Etching equipment
- Spatter equipment
- Cleaning equipment
- Coating equipment
- Dicing equipment
- Tester, etc.

Medical

Example: Blood preservation

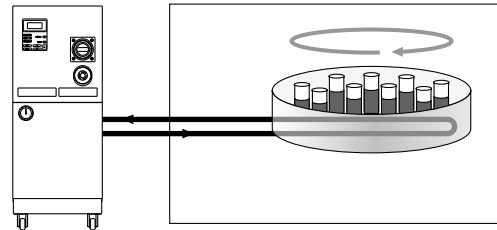

- X-ray instrument
- MRI
- Blood preservation equipment

Food

Example: Tofu (Bean curd) production

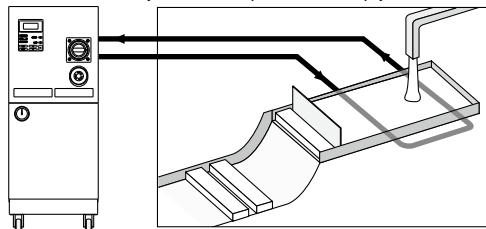

- Bottle-cleaning machine
 - Tofu (Bean curd) production equipment
 - Noodle-making machine, etc.
- Water temperature control for forming tofu by mixing the boiled soybean milk and bittern

Analysis

Example: Electronic microscope

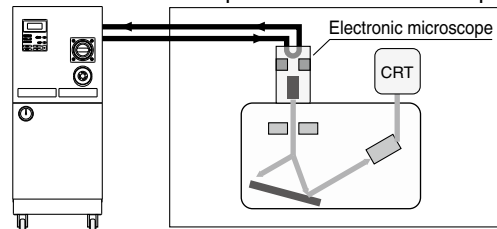

- Electron microscope
 - X-ray analytical instrument
 - Gas chromatography
 - Sugar level analytical instrument, etc.
- Prevents the distortion caused by the heat generated by the electronic gun in an electronic microscope.

Machine tool

Example: Laser machining

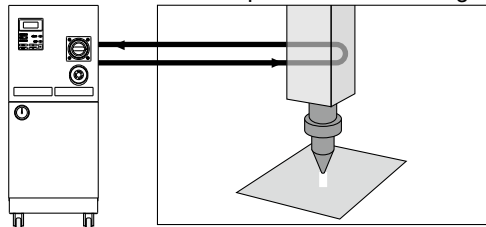

- Wire cutting
 - Grinder
 - Spot welding
 - Plasma welding
 - Laser machining, etc.
- Temperature-controlling the laser generating tube enables the laser wavelength to be optimised, improving the accuracy of the machined cross sectional area.

Printing

Example: Printing temperature control

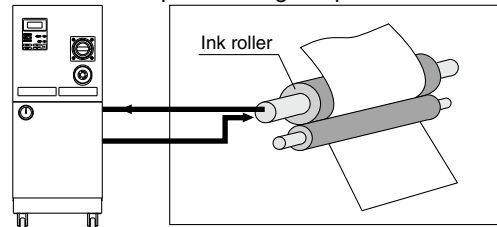

- Offset printing machine
 - Automatic developing machine
 - UV equipment, etc.
- Temperature-controlling the ink roller enables to control the evaporation amount and viscosity of an ink and optimise the tint of colors.

Molding

Example: Injection molding

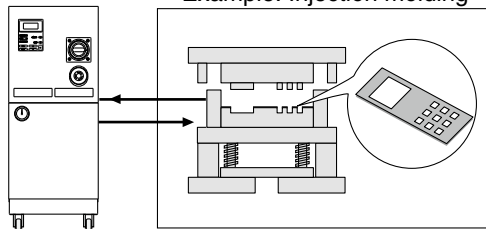

- Plastic molding
 - Rubber molding
 - Wire cable coating machine
 - Injection molding, etc.
- Temperature-controlling the mold results in improved product quality.

HRS

HRS-R

HRS090

HRS 100/150

HRS200

HRSH090

HRSH

HRS-E

HRR

HRL

HRZ

HRZD

HRW

HECR

HEC

HEB

HED

Technical Data

Construction and Principles

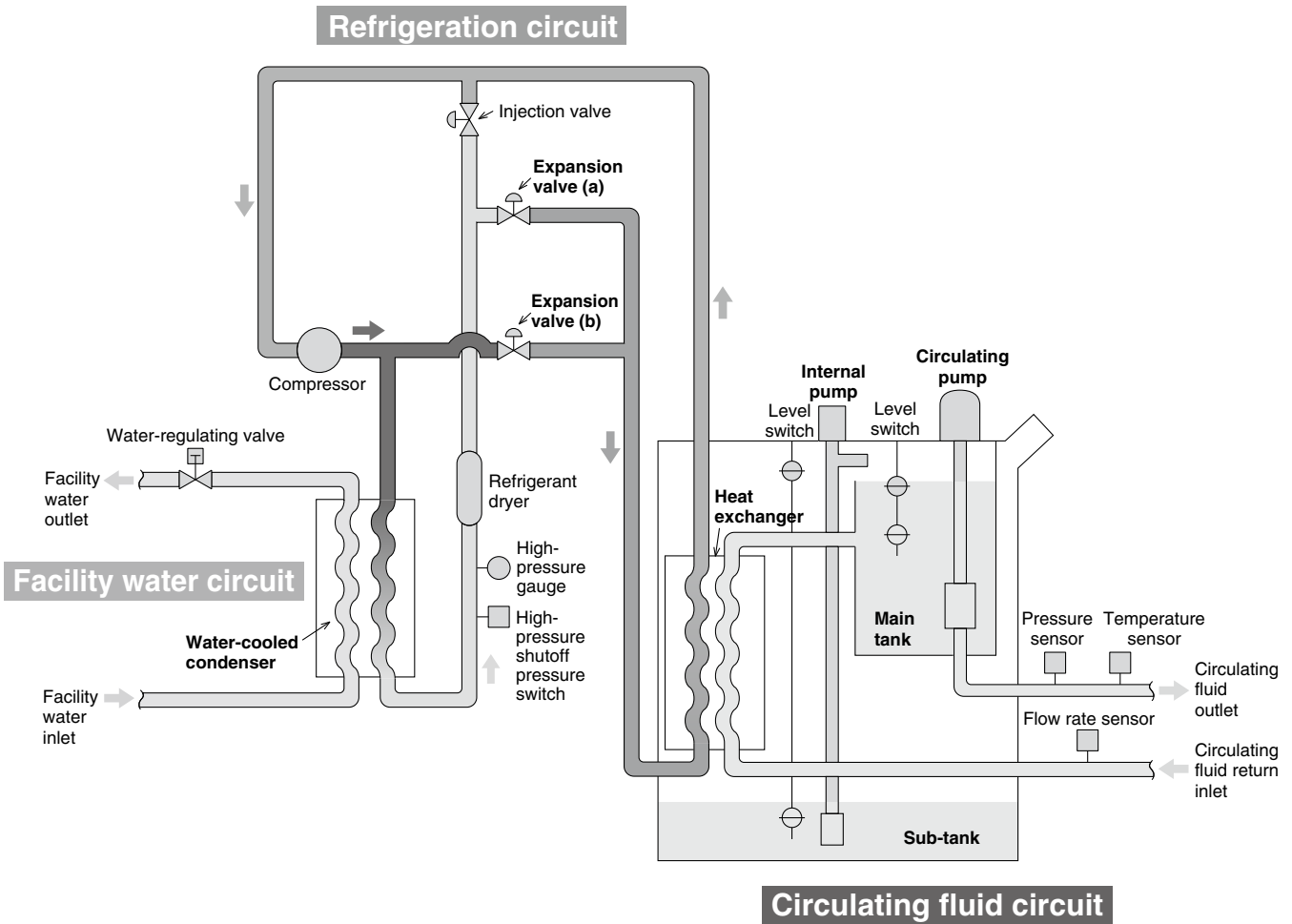

Circulating fluid circuit

With the **circulating pump**, circulating fluid will be discharged to the user's equipment side. After the circulating fluid will heat or cool the user's equipment side, it will be returned to the **main tank** via the **heat exchanger**.

A **sub-tank** is not used under the normal operation. It will be used when a circulating fluid is recovered from the user's equipment side.

The **internal pump** is used to transfer a circulating fluid from the **sub-tank** to the **main tank**. (Refer to "Circulating fluid automatic recovery function" on page 347.)

Refrigeration circuit

When the circulating fluid temperature is rising higher than the set temperature, open the **expansion valve (a)** to introduce refrigerant gas at a lower temperature to the **heat exchanger**. With this, the circulating fluid will be cooled down.

Oppositely, when the circulating fluid is getting lower against the set temperature, open the **expansion valve (b)** and introduce refrigerant gas at a high temperature without going through the **water-cooled condenser** to the **heat exchanger**. With this heat, the circulating fluid will be heated.

CONTENTS

HRZ Series



Refrigerated Thermo-chiller HRZ Series

● Model Selection

Guide to Model Selection	Page 351
Required Cooling Capacity Calculation	Page 352
Precautions on Model Selection	Page 353
Circulating Fluid Typical Physical Property Values	Page 354

● Fluorinated Fluid Type

How to Order/Specifications	Page 355
Cooling Capacity/Heating Capacity	Page 356
Pump Capacity	Page 357

● Ethylene Glycol Type

How to Order/Specifications	Page 358
Cooling Capacity/Heating Capacity	Page 359
Pump Capacity	Page 360

● Tap/Deionized Water Type

How to Order/Specifications	Page 361
Cooling Capacity/Heating Capacity/Pump Capacity	Page 362

● Double Inverter Type

How to Order/Specifications	Page 363
Cooling Capacity/Heating Capacity/Pump Capacity	Page 364

● Common Specifications

Dimensions	Page 365
Communication Functions	Page 367
· Contact Input/Output	Page 367
· Serial RS-485	Page 368
· Connector Location	Page 368
Operation Display Panel	Page 369
Alarm	Page 369

● Optional Accessories

① Bypass Piping Set	Page 370
② Anti-quake Bracket	Page 370
③ 4-Port Manifold	Page 371
④ DI Filter	Page 371
⑤ Insulating Material for DI Filter	Page 371
⑥ 60% Ethylene Glycol Aqueous Solution	Page 372
⑦ Concentration Meter	Page 372

● Options

Analog Communication	Page 373
DeviceNet Communication	Page 373
NPT Fitting	Page 373
SI Unit Only	Page 373
DI Control Kit	Page 373
Circulating Fluid Automatic Recovery	Page 374
EU F-Gas Regulation-compliant	Page 375

Specific Product Precautions	Page 378
------------------------------	----------

HRZ Series Model Selection

Guide to Model Selection

1. How much is the temperature in degrees centigrade for the circulating fluid?

Temperature range which can be set with the thermo-chiller

L : -20°C to 40°C (“L2” (tap water, deionized water specification) can be set 10°C to 40°C.)

H : 20°C to 90°C

W: -20°C to 90°C (Select “W” only when the temperature ranges of “L” or “H” are not applicable. HRZ010-W2S (tap water, deionized water specification) can be set 10°C to 60°C.)

Example) User requirement: 50°C (→ Temperature range 20°C to 90°C, “H” type will be appropriate.)

2. What kind of the circulating fluids will be used?

Relationship between circulating fluid (which can be used with the thermo-chiller) and temperature

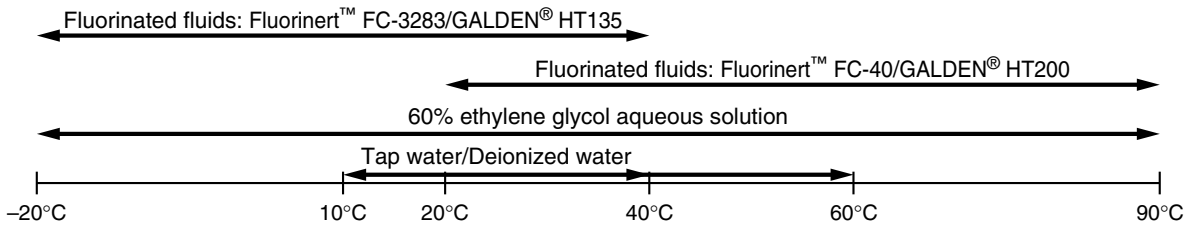

Example) User requirement: Fluorinated fluids

Based on the results 1. and 2., Cooling capacity relating “Fluorinated fluids” and “Temperature range 20°C to 90°C” is shown on page 356.

3. What is the kW for the required cooling capacity?

* To calculate the cooling capacity, referring to page 352.

Example) User requirement: 5 kW →

Plot the point of intersection between the operating temperature (50°C) and the cooling capacity (5 kW) in the cooling capacity graph.

[Cooling Capacity Graph] Circulating Fluid: Fluorinated Fluids, Temperature Range: 20 to 90°C

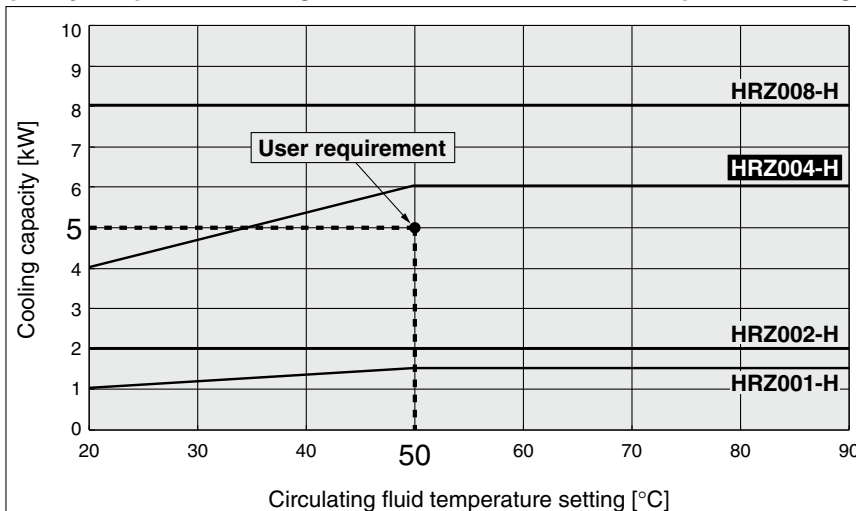

The point plotted in the graph is the requirement from the user. Select the thermo-chiller models exceeding this point. In this case, select the **HRZ004-H**.

GALDEN® is a registered trademark, belonging to the Solvay Group or its corresponding owner. Fluorinert™ is a trademark of 3M.

Required Cooling Capacity Calculation

Example 1: When the heat generation amount in the user's equipment is known.

Heat generation amount **Q**: 3.5 kW

Cooling capacity = Considering a safety factor of 20%, $3.5 \times 1.2 = \boxed{4.2 \text{ kW}}$

Example 2: When the heat generation amount in the user's equipment is not known.

Obtain the temperature difference between inlet and outlet by circulating the circulating fluid inside the user's equipment.

Heat generation amount **Q** : Unknown
 Circulating fluid temperature difference $\Delta T (= T2 - T1)$: 6.0°C (6.0 K)
 Circulating fluid outlet temperature **T1** : 20°C (293.15 K)
 Circulating fluid return temperature **T2** : 26°C (299.15 K)
 Circulating fluid flow rate **L** : 20 L/min
 Circulating fluid : Fluorinated fluid
 Density γ : $1.80 \times 10^3 \text{ kg/m}^3$
 Specific heat **C**: $0.96 \times 10^3 \text{ J/(kg}\cdot\text{K)}$ (at 20°C)

* Refer to page 354 for the typical physical property values by circulating fluid.

$$Q = \frac{\Delta T \times L \times \gamma \times C}{60 \times 1000}$$

$$= \frac{6.0 \times 20 \times 1.80 \times 10^3 \times 0.96 \times 10^3}{60 \times 1000}$$

$$= 3456 \text{ W} = 3.5 \text{ kW}$$

Cooling capacity = Considering a safety factor of 20%,
 $3.5 \times 1.2 = \boxed{4.2 \text{ kW}}$

Example of conventional units (Reference)

Unknown
 6.0°C
 20°C
 26°C
 1.2 m³/h
 Fluorinated fluid
 Density γ : $1.80 \times 10^3 \text{ kg/m}^3$
 Specific heat **C**: 0.23 kcal/kg·°C (at 20°C)

* Refer to page 354 for the typical physical property values by circulating fluid.

$$Q = \frac{\Delta T \times L \times \gamma \times C}{860}$$

$$= \frac{6.0 \times 1.2 \times 1.80 \times 10^3 \times 0.23}{860}$$

$$= 3.5 \text{ kW}$$

Cooling capacity = Considering a safety factor of 20%,
 $3.5 \times 1.2 = \boxed{4.2 \text{ kW}}$

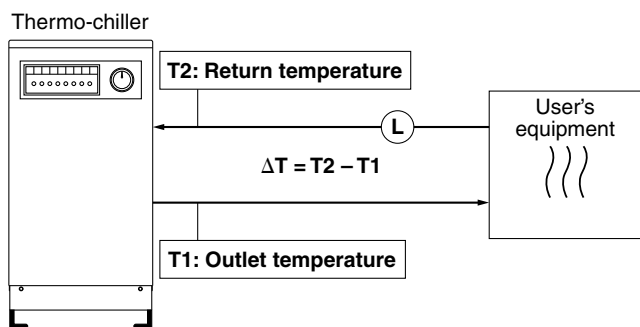

HRS
 HRS-R
 HRS090
 HRS/150
 HRS200
 HRS090
 HRS
 HRS-E
 HRS
 HRL
 HRZ
 HRZD
 HRW
 HECR
 HEC
 HEB
 HED
 Technical Data

Required Cooling Capacity Calculation

Example 3. When there is no heat generation, and when cooling the object below a certain temperature and period of time.

Cooled substance total volume **V** : 60 L
 Cooling time **h** : 15 min
 Cooling temperature difference ΔT : $\left\{ \begin{array}{l} 20^{\circ}\text{C} \text{ (20 K)} \\ (40^{\circ}\text{C} - 20^{\circ}\text{C} \rightarrow 20^{\circ}\text{C}) \end{array} \right.$
 Circulating fluid : Fluorinated fluid
 Density γ : $1.80 \times 10^3 \text{ kg/m}^3$
 Specific heat **C**: $0.96 \times 10^3 \text{ J/(kg}\cdot\text{K)}$
 (at 20°C)

* Refer to page 354 for the typical physical property values by circulating fluid.

$$Q = \frac{\Delta T \times V \times \gamma \times C}{h \times 60 \times 1000}$$

$$= \frac{20 \times 60 \times 1.80 \times 10^3 \times 0.96 \times 10^3}{15 \times 60 \times 1000}$$

$$= 2304 \text{ W} = 2.3 \text{ kW}$$

Cooling capacity = Considering a safety factor of 20%,

$$2.3 \times 1.2 = \mathbf{2.8 \text{ kW (When the circulating fluid temperature is } 20^{\circ}\text{C.)}}$$

(In this case, selected thermo-chiller model will be either HRZ002-L or HRZ004-H.)

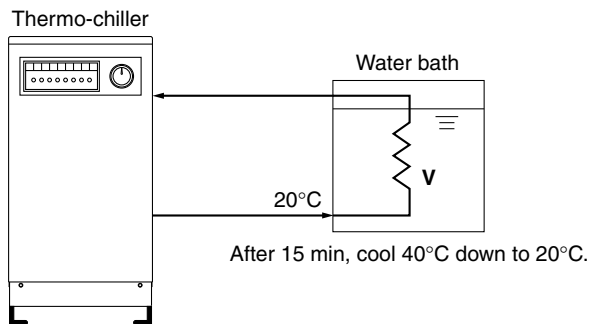

* This is the calculated value by changing the fluid temperature only. Thus, it varies substantially depending on the water bath or piping material or shape.

Example of conventional units (Reference)

0.06 m³
 0.25 h
 20°C
 Fluorinated fluid
 Density γ : $1.80 \times 10^3 \text{ kg/m}^3$
 Specific heat **C**: $0.23 \text{ kcal/kg}\cdot^{\circ}\text{C}$
 (at 20°C)

* Refer to page 354 for the typical physical property values by circulating fluid.

$$Q = \frac{\Delta T \times V \times \gamma \times C}{h \times 860}$$

$$= \frac{20 \times 0.06 \times 1.80 \times 10^3 \times 0.23}{0.25 \times 860}$$

$$= 2.3 \text{ kW}$$

Cooling capacity = Considering a safety factor of 20%,

$$2.3 \times 1.2 = \mathbf{2.8 \text{ kW (When the circulating fluid temperature is } 20^{\circ}\text{C.)}}$$

(In this case, selected thermo-chiller model will be either HRZ002-L or HRZ004-H.)

Precautions on Model Selection

1. Heating capacity

When setting the circulating fluid temperature at a higher temperature than the room temperature, the circulating fluid temperature will be heated with the thermo-chiller. Heating capacity varies depending on the model of the HRZ series. Also, the heating capacity varies depending on the circulating fluid temperature. Consider the heat radiation amount or thermal capacity of the user's equipment. Check beforehand if the required heating capacity is provided, based on the heating capacity graph for the respective model.

2. Pump capacity

<Circulating fluid flow rate>

Pump capacity varies depending on the model selected from the HRZ series. Also, circulating fluid flow varies depending on the circulating fluid discharge pressure. Consider the installation height difference between our thermo-chiller and a user's equipment, and the piping resistance such as circulating fluid pipings, or piping size, or piping curves in the machine. Check beforehand if the required flow is achieved using the pump capacity curves for each respective model.

<Circulating fluid discharge pressure>

Circulating fluid discharge pressure has the possibility to increase up to the maximum pressure in the pump capacity curves for the respective model. Check beforehand if the circulating fluid pipings or circulating fluid circuit of the user's equipment are fully durable against this pressure.

Circulating Fluid Typical Physical Property Values

* Shown below are reference values.
Please contact circulating fluid supplier for details.

Fluorinated Fluids

Physical property value Temperature	Density γ	Specific heat C	
	[kg/m ³] [g/L]	[J/(kg·K)]	[(kcal/kg·°C)]
-10°C	1.87 x 10 ³	0.87 x 10 ³	(0.21)
20°C	1.80 x 10 ³	0.96 x 10 ³	(0.23)
50°C	1.74 x 10 ³	1.05 x 10 ³	(0.25)
80°C	1.67 x 10 ³	1.14 x 10 ³	(0.27)

60% Ethylene Glycol Aqueous Solution

Physical property value Temperature	Density γ	Specific heat C	
	[kg/m ³] [g/L]	[J/(kg·K)]	[(kcal/kg·°C)]
-10°C	1.10 x 10 ³	3.02 x 10 ³	(0.72)
20°C	1.08 x 10 ³	3.15 x 10 ³	(0.75)
50°C	1.06 x 10 ³	3.27 x 10 ³	(0.78)
80°C	1.04 x 10 ³	3.40 x 10 ³	(0.81)

Water

Density γ : 1 x 10³ [kg/m³] [g/L]

Specific heat C: 4.2 x 10³ [J/(kg·K)] (1.0 [kcal/kg·°C])

- HRS
- HRS-R
- HRS090
- HRS 100/150
- HRS200
- HRS090
- HRS
- HRS
- HRS
- HRS
- HRS
- HRZ
- HRZD
- HRW
- HECR
- HEC
- HEB
- HED
- Technical Data

Thermo-chiller Fluorinated Fluid Type

HRZ Series



SEMI

The models on this page are to be discontinued as of December 2021. Therefore, we recommend considering an HRZ-F series model instead. For further details on the HRZ-F series, refer [here](#).

How to Order

Fluorinated Fluid Type **HRZ 001** - **L** -

Cooling capacity

Symbol	Cooling capacity
001	1 kW
002	2 kW
004	4 kW
008	8 kW

Temperature range setting

Symbol	Temperature range setting	1 kW	2 kW	4 kW	8 kW
L	-20 to 40°C	●	●	—	—
H	20 to 90°C	●	●	●	●
W	-20 to 90°C	—	●	—	●

Option (Refer to pages 373 and 374.)

Symbol	Contents
Nil	None
C	Analog communication
D	DeviceNet communication
N	NPT fitting
W	SI Unit Only
Z	Circulating fluid automatic recovery

• When multiple options are combined, indicate symbols in alphabetical order.

Specifications (For details, please refer to our "Product Specifications" information.)

Model	HRZ001-L	HRZ002-L	HRZ001-H	HRZ002-H	HRZ004-H	HRZ008-H	HRZ002-W	HRZ008-W	
Cooling method	Water-cooled refrigeration								
Refrigerant	R404A (HFC)								
Refrigerant charge kg	1.15	1.15	0.75	0.75	1.15	1.15	1.15	1.15	
Control system	PID control								
Ambient temp./humidity*1	Temperature: 10 to 35°C, Humidity: 30 to 70%RH								
Circulating fluid system	Circulating fluid*2	Fluorinert™ FC-3283/ GALDEN® HT135		Fluorinert™ FC-40/GALDEN® HT200			<ul style="list-style-type: none"> -20 to 40°C: Fluorinert™ FC-3283/GALDEN® HT135 20 to 90°C: Fluorinert™ FC-40/GALDEN® HT200 		
	Temp. range setting*1 °C	-20 to 40		20 to 90			-20 to 90		
	Cooling capacity*3 kW	1.0 (at -10°C)	2.0 (at -10°C)	1.0 (at 20°C)	2.0 (at 20°C)	4.0 (at 20°C)	8.0 (at 20°C)	2.0 (at 20°C)	8.0 (at 20°C)
	Heating capacity*3 kW	2.8 (at -10°C)	3.2 (at -10°C)	2.3 (at 20°C)	2.6 (at 20°C)	2.8 (at 20°C)	3.0 (at 20°C)	2.3 (at 20°C)	3.3 (at 20°C)
	Temp. stability*4 °C	±0.1							
	Pump capacity (50/60 Hz)*5 MPa	0.45/0.65 (at 20 L/min)		0.40/0.60 (at 20 L/min)			0.45/0.65 (at 20 L/min)		
	Rated flow*6 L/min	20		20					
	Main tank capacity*7 L	Approx. 15		Approx. 12			Approx. 15		
	Sub-tank capacity*8 L	Approx. 16		Approx. 15			Approx. 16		
	Port size	Rc3/4							
Fluid contact material	Stainless steel, EPDM, Copper brazing (Heat exchanger), PPS, Silicone, Fluororesin								
Cooling water system	Temperature range °C	10 to 25							
	Pressure range MPa	0.3 to 0.7							
	Required flow rate (50/60 Hz)*9 L/min	5/5	6/6	3/4	5/6	9/10	13/14	6/7	13/14
Port size	Rc1/2								
Fluid contact material	Stainless steel, EPDM, Copper brazing (Heat exchanger), Silicone, Brass, NBR								
Electrical system	Power supply	3-phase 200 VAC 50 Hz, 3-phase 200 to 208 VAC 60 Hz Allowable voltage range ±10%							
	Breaker capacity A	30		20			30		
	Rated current A	20		14			23		
	Alarm	Refer to page 369.							
	Communications	Contact input/output (D-sub 25 pin) and Serial RS-485 (D-sub 9 pin) (Refer to pages 367 and 368.)							
Weight*10 kg	165		145			165			
Safety standards*11	UL, CE marking, SEMI (S2, S8, F47), SEMATECH (S2, S8)								

*1 No condensation should be present.
 *2 GALDEN® is a registered trademark, belonging to the Solvay Group or its corresponding owner. Fluorinert™ is a trademark of 3M. Regarding the fluid other than the above, please contact SMC.
 *3 ① Facility water temperature: 25°C, ② Circulating fluid flow rate: Values at the rated circulating fluid flow rate. Values common for 50/60 Hz.
 *4 Value with a stable load without turbulence in the operating conditions. It may be out of this range depending on operating conditions.
 *5 The capacity at the thermo-chiller outlet when the circulating fluid temperature is 20°C
 *6 The required flow rate for maintaining the cooling capacity or temperature stability. When used below the rated flow, use the individually sold, "Bypass Piping Set" (Refer to page 370).
 *7 Minimum volume required for operating only the thermo-chiller. (Circulating fluid temperature: 20°C, including the thermo-chiller's internal pipings or heat exchanger)
 *8 Preliminary space volume without main tank capacity. Available for collecting the circulating fluid inside an external piping or for preliminary injection.
 *9 The required flow rate when the cooling capacity load is applied at a facility water temperature of 25°C
 *10 Weight in the dry state without circulating fluids
 *11 The import of products using R404A as a refrigerant, even if they have a CE mark, into the EU is prohibited.

Cooling Capacity

HRZ001-L/002-L

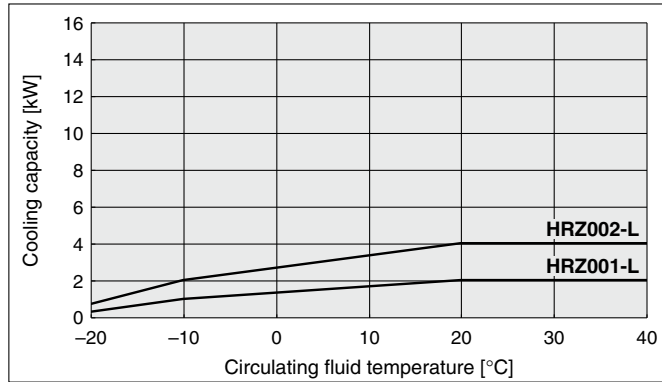

HRZ001-H/002-H/004-H/008-H

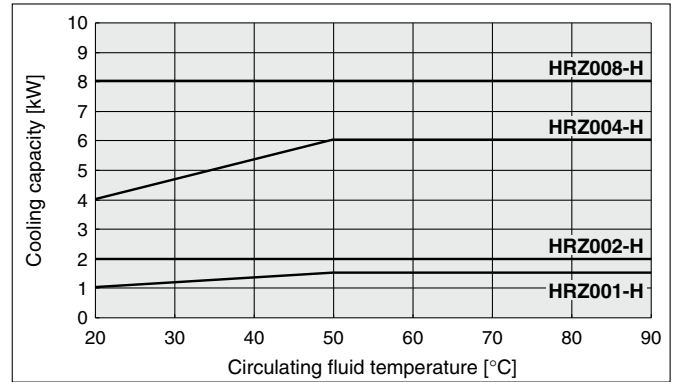

HRZ002-W/008-W

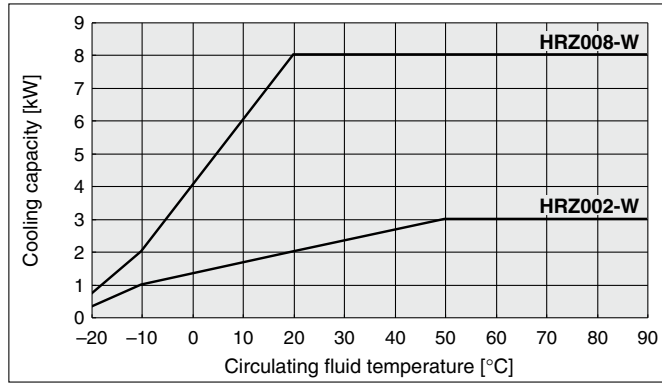

Heating Capacity

HRZ001-L/002-L

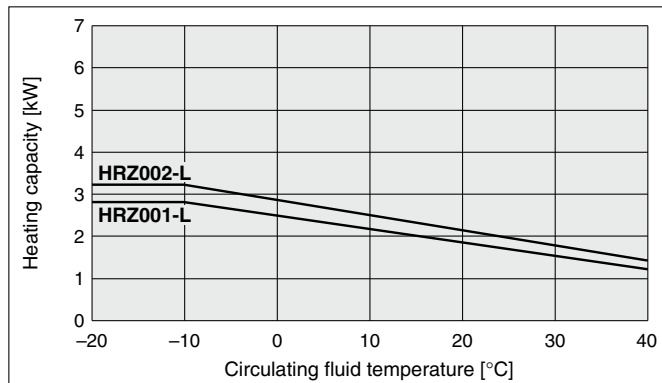

HRZ001-H/002-H/004-H/008-H

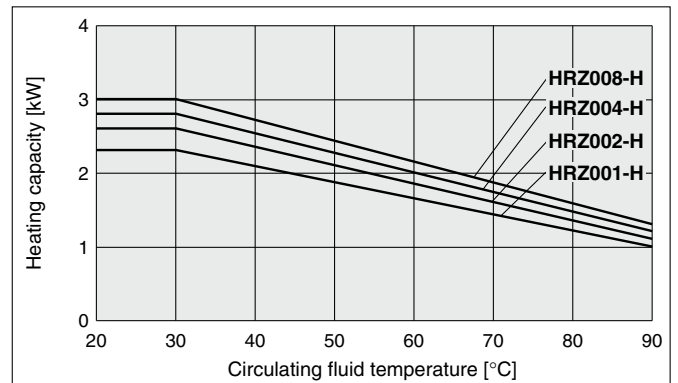

HRZ002-W/008-W

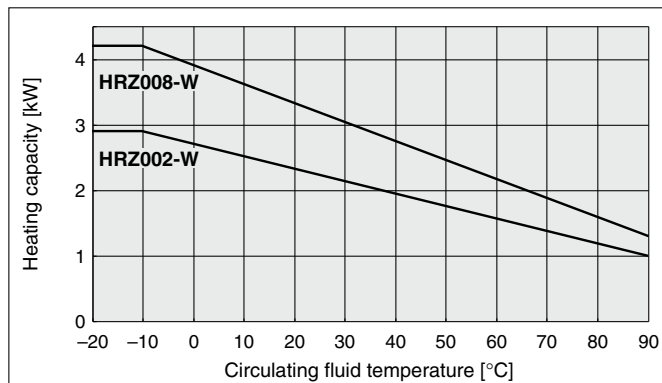

- HRZ
- HRZ001-L
- HRZ001-H
- HRZ002-L
- HRZ002-H
- HRZ002-W
- HRZ004-H
- HRZ008-H
- HRZ008-W
- HRZD
- HRW
- HECR
- HEC
- HEB
- HED
- Technical Data

HRZ Series

Pump Capacity (Thermo-chiller Outlet)

HRZ001-L/002-L

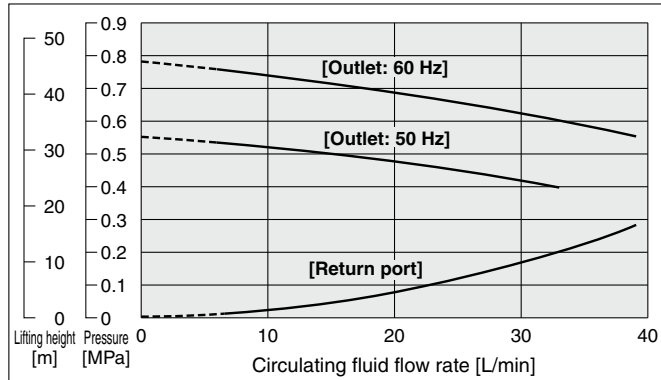

HRZ001-H/002-H

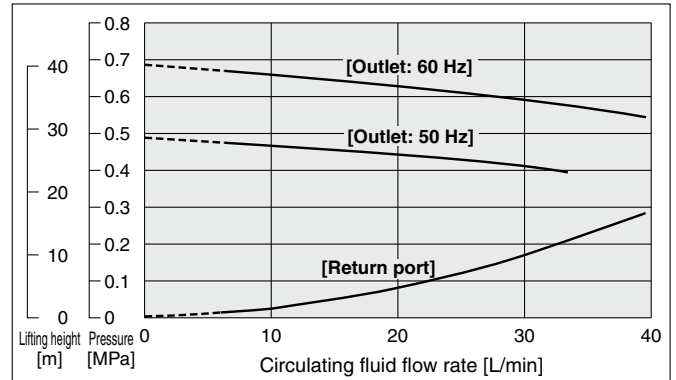

HRZ004-H/008-H

HRZ002-W/008-W

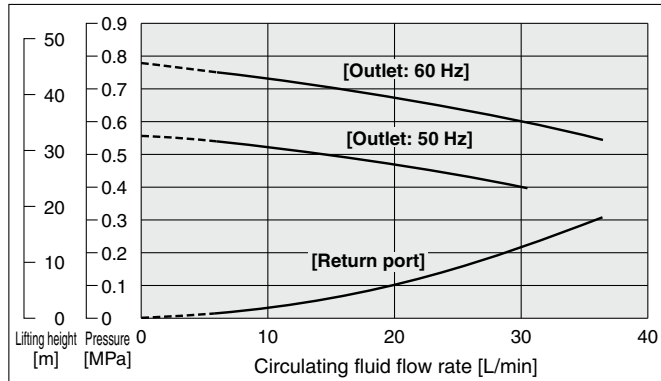

* When the circulating fluid flow is below 6 L/min, the in-built operation stop alarm will be activated. It is not possible to run the equipment. (common for all models)

Thermo-chiller Ethylene Glycol Type

HRZ Series



SEMI

The models on this page are to be discontinued as of December 2021. Therefore, we recommend considering an HRZ-F series model instead. For further details on the HRZ-F series, refer [here](#).

How to Order

Ethylene Glycol Type **HRZ 001 - L 1 -**

Cooling capacity

Symbol	Cooling capacity
001	1 kW
002	2 kW
004	4 kW
008	8 kW

Temperature range setting

Symbol	Temperature range setting	1 kW	2 kW	4 kW	8 kW
L	-20 to 40°C	●	●	—	—
H	20 to 90°C	●	●	●	●
W	-20 to 90°C	—	●	—	●

Option (Refer to pages 373 and 374.)

Symbol	Contents
Nil	None
C	Analog communication
D	DeviceNet communication
N	NPT fitting
W	SI Unit Only
Y	DI Control Kit
Z	Circulating fluid automatic recovery

• When multiple options are combined, indicate symbols in alphabetical order.

Ethylene glycol type

Specifications (For details, please refer to our "Product Specifications" information.)

Model	HRZ001-L1	HRZ002-L1	HRZ001-H1	HRZ002-H1	HRZ004-H1	HRZ008-H1	HRZ002-W1	HRZ008-W1	
Cooling method	Water-cooled refrigeration								
Refrigerant	R404A (HFC)								
Refrigerant charge kg	1.15	1.15	0.75	0.75	1.15	1.15	1.15	1.15	
Control system	PID control								
Ambient temp./humidity *1	Temperature: 10 to 35°C, Humidity: 30 to 70%RH								
Circulating fluid system	Circulating fluid *2	60% ethylene glycol aqueous solution							
	Temp. range setting *1 °C	-20 to 40				20 to 90			
	Cooling capacity *3 kW	1.0 (at -10°C)	2.0 (at -10°C)	1.0 (at 20°C)	2.0 (at 20°C)	4.0 (at 20°C)	8.0 (at 20°C)	2.0 (at 20°C)	8.0 (at 20°C)
	Heating capacity *3 kW	2.5 (at -10°C)	2.9 (at -10°C)	1.8 (at 20°C)	2.1 (at 20°C)	2.5 (at 20°C)	3.0 (at 20°C)	2.2 (at 20°C)	3.3 (at 20°C)
	Temp. stability *4 °C	±0.1							
	Pump capacity (50/60 Hz) *5 MPa	0.25/0.40 (at 20 L/min)		0.25/0.35 (at 20 L/min)		0.25/0.40 (at 20 L/min)			
	Rated flow *6 L/min	20							
	Main tank capacity *7 L	Approx. 15		Approx. 12		Approx. 15			
	Sub-tank capacity *8 L	Approx. 16		Approx. 15		Approx. 16			
	Port size	Rc3/4							
Cooling water system	Fluid contact material	Stainless steel, EPDM, Copper brazing (Heat exchanger), PPS, Silicone, Fluoro-resin							
	Temperature range °C	10 to 25							
	Pressure range MPa	0.3 to 0.7							
	Required flow rate (50/60 Hz) *9 L/min	5/5	6/6	3/4	5/6	9/10	13/14	5/7	13/14
	Port size	Rc1/2							
Electrical system	Fluid contact material	Stainless steel, EPDM, Copper brazing (Heat exchanger), Silicone, Brass, NBR							
	Power supply	3-phase 200 VAC 50 Hz, 3-phase 200 to 208 VAC 60 Hz Allowable voltage range ±10%							
	Breaker capacity A	30		20		30			
	Rated current A	19		14		23			
	Alarm	Refer to page 369.							
Communications	Contact input/output (D-sub 25 pin) and Serial RS-485 (D-sub 9 pin) (Refer to pages 367 and 368.)								
Weight *10 kg	165		145		165				
Safety standards *11	UL, CE marking, SEMI (S2, S8, F47), SEMATECH (S2, S8)								

- *1 No condensation should be present.
- *2 Dilute pure ethylene glycol with tap water. Additives such as preservatives cannot be used.
- *3 ① Facility water temperature: 25°C, ② Circulating fluid flow rate: Values at the rated circulating fluid flow rate. Values common for 50/60 Hz.
- *4 Value with a stable load without turbulence in the operating conditions. It may be out of this range when a DI control kit (option Y) is used or in some other operating conditions.
- *5 The capacity at the thermo-chiller outlet when the circulating temperature is 20°C
- *6 The required flow rate for maintaining the cooling capacity or temperature stability. When used below the rated flow, use the individually sold, "Bypass Piping Set" (Refer to page 370).
- *7 Minimum volume required for operating only the thermo-chiller. (Circulating fluid temperature: 20°C, including the thermo-chiller's internal pipings or heat exchanger)
- *8 Preliminary space volume without main tank capacity. Available for collecting the circulating fluid inside an external piping or for preliminary injection.
- *9 The required flow rate when the cooling capacity load is applied at a facility water temperature of 25°C
- *10 Weight in the dry state without circulating fluids
- *11 The import of products using R404A as a refrigerant, even if they have a CE mark, into the EU is prohibited.

HRS
HRS-R
HRS090
HRS 100/150
HRS200
HRS090
HRSH
HRSE
HRR
HRL
HRZ
HRZD
HRW
HECR
HEC
HEB
HED
Technical Data

HRZ Series

Cooling Capacity

HRZ001-L1/002-L1

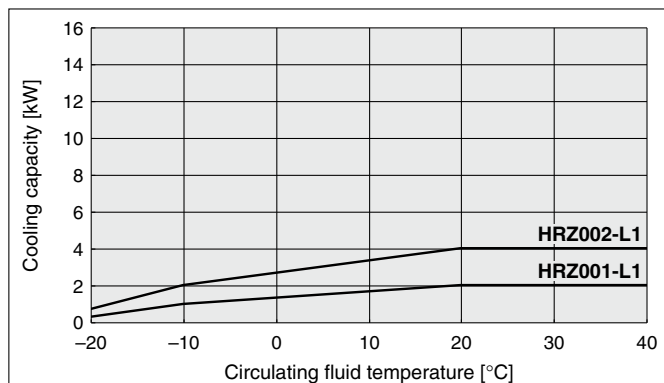

HRZ001-H1/002-H1/004-H1/008-H1

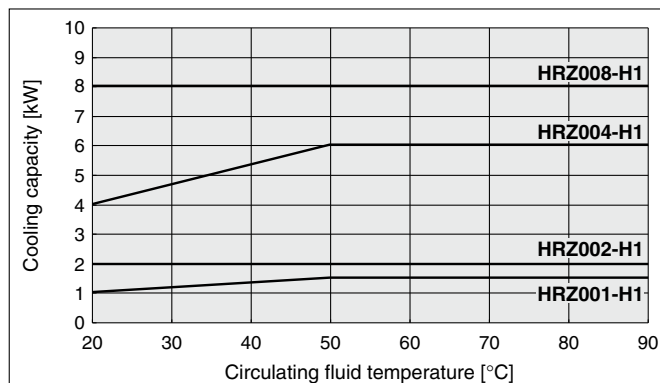

HRZ002-W1/008-W1

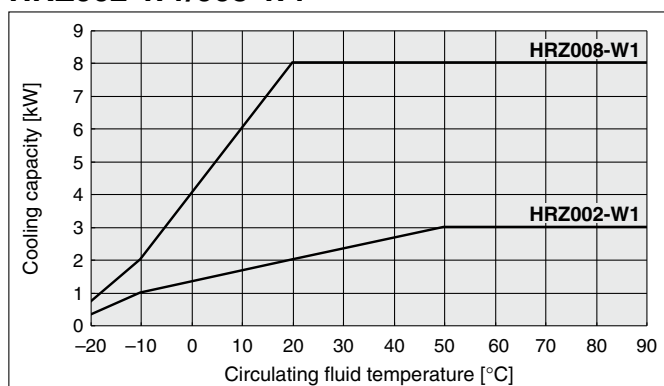

Heating Capacity

HRZ001-L1/002-L1

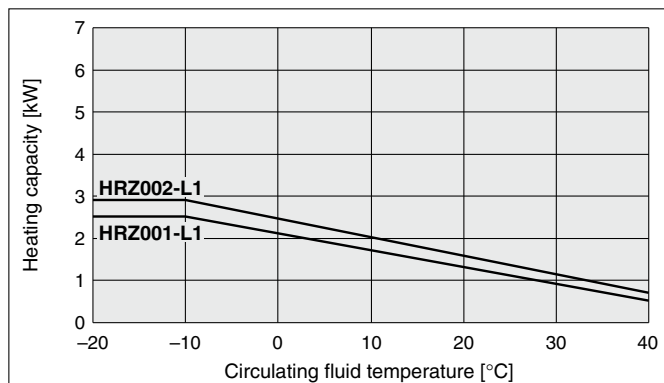

HRZ001-H1/002-H1/004-H1/008-H1

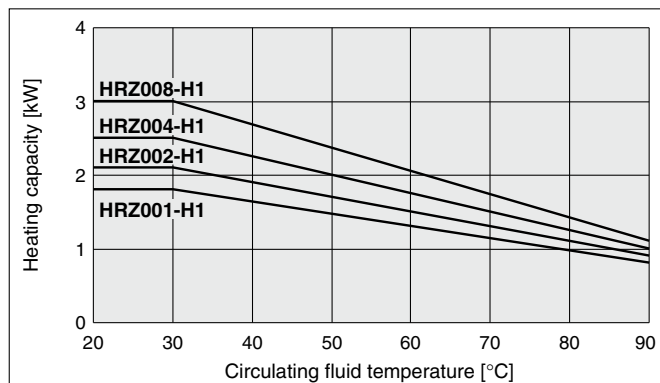

HRZ002-W1/008-W1

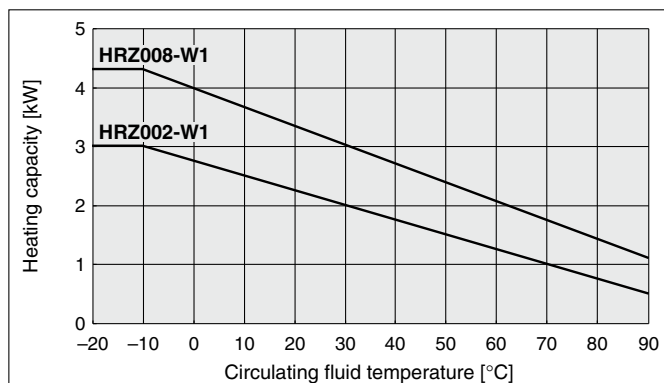

Pump Capacity (Thermo-chiller Outlet)

HRZ001-L1/002-L1
HRZ004-H1/008-H1
HRZ002-W1/008-W1

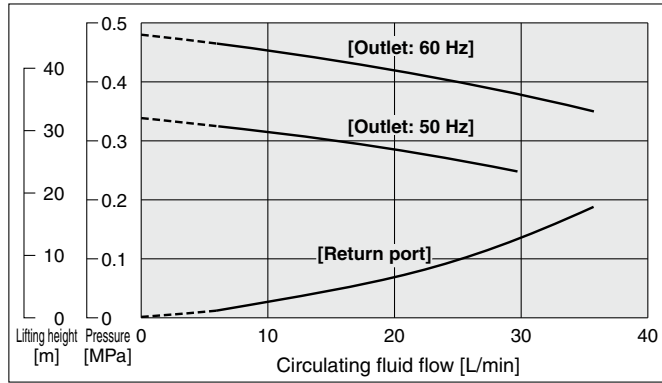

HRZ001-H1/002-H1

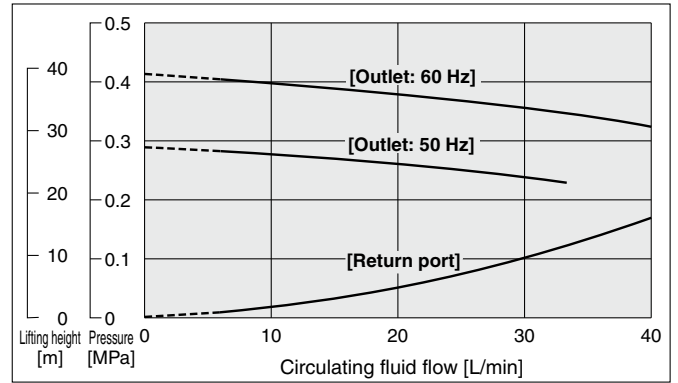

* When the circulating fluid flow is below 6 L/min, the in-built operation stop alarm will be activated. It is not possible to run the equipment. (common for all models)

- HRZ
- HRZD
- HRW
- HECR
- HEC
- HEB
- HED
- HRZ
- HRL
- HRR
- HRSE
- HRSH
- HRSH090
- HRZ200
- HRZ100/150
- HRZ090
- HRZ-R
- HRZ

Thermo-chiller Tap/Deionized Water Type

HRZ Series



SEMI

The models on this page are to be discontinued as of December 2021. Therefore, we recommend considering an HRZ-F series model instead. For further details on the HRZ-F series, refer [here](#).

How to Order

Tap/Deionized Water Type **HRZ 001-L 2-** []

Cooling capacity

Symbol	Cooling capacity
001	1 kW
002	2 kW
004	4 kW
008	8 kW

Temperature range setting

Symbol	Temperature range setting	1 kW	2 kW	4 kW	8 kW
L	10 to 40°C	●	●	●	●

Tap/Deionized water type

Option (Refer to pages 373 and 374.)

Symbol	Contents
Nil	None
C	Analog communication
D	DeviceNet communication
N	NPT fitting
W	SI unit only
Y	DI control kit
Z	Circulating fluid automatic recovery

• When multiple options are combined, indicate symbols in alphabetical order.

Specifications (For details, please refer to our "Product Specifications" information.)

Model	HRZ001-L2	HRZ002-L2	HRZ004-L2	HRZ008-L2	
Cooling method	Water-cooled refrigeration				
Refrigerant	R134a (HFC)				
Refrigerant charge kg	1.1	1.1	1.1	1.1	
Control system	PID control				
Ambient temperature/humidity *1	Temperature: 10 to 35°C, Humidity: 30 to 70%RH				
Circulating fluid system	Circulating fluid *2	Tap water, Deionized water			
	Temperature range setting *1 °C	10 to 40			
	Cooling capacity *3 kW	1.0 (at 20°C)	2.0 (at 20°C)	4.0 (at 20°C)	8.0 (at 20°C)
	Heating capacity *3 kW	0.90 (at 20°C)	0.98 (at 20°C)	1.15 (at 20°C)	1.25 (at 20°C)
	Temperature stability *4 °C	±0.1			
	Pump capacity (50/60 Hz) *5 MPa	0.25/0.38 (at 20 L/min)			
	Rated flow *6 L/min	20			
	Main tank capacity *7 L	Approx. 15			
	Sub-tank capacity *8 L	Approx. 16			
	Port size	Rc3/4			
Fluid contact material	Stainless steel, EPDM, Copper brazing (Heat exchanger), PPS, Silicone, Fluororesin				
Cooling water system	Temperature range °C	10 to 25			
	Pressure range MPa	0.3 to 0.7			
	Required flow rate (50/60 Hz) *9 L/min	5/5	6/6	15/22	18/23
	Port size	Rc1/2			
Fluid contact material	Stainless steel, EPDM, Copper brazing (Heat exchanger), Silicone, Brass, NBR				
Electrical system	Power supply	3-phase 200 VAC 50 Hz, 3-phase 200 to 208 VAC 60 Hz Allowable voltage range ±10%			
	Breaker capacity A	30			
	Rated current A	19			
	Alarm	Refer to page 369.			
	Communications	Contact input/output (D-sub 25 pin) and Serial RS-485 (D-sub 9 pin) (Refer to pages 367 and 368.)			
Weight *10 kg	165				
Safety standards	UL, CE marking, SEMI (S2, S8, F47), SEMATECH (S2, S8)				

*1 No condensation should be present.

*2 If tap water or deionized water is used, use water that is compliant with the Water Quality Standards of the Japan Refrigeration and Air Conditioning Industry Association (JRA GL-02-1994/cooling water system - circulation type - make-up water). The minimum electric conductivity of the deionized water used as the fluid should be 0.5 μS/cm (or electric resistivity 2 MΩ·cm at maximum).

*3 ① Facility water temperature: 25°C, ② Circulating fluid flow rate: Values at the rated circulating fluid flow rate. Values common for 50/60 Hz.

*4 Value with a stable load without turbulence in the operating conditions. It may be out of this range when a DI control kit (option Y) is used or in some other operating conditions.

*5 The capacity at the thermo-chiller outlet when the circulating fluid temperature is 20°C

*6 The required flow rate for maintaining the cooling capacity or temperature stability. When used below the rated flow, use the individually sold, "Bypass Piping Set" (Refer to page 370).

*7 Minimum volume required for operating only the thermo-chiller. (Circulating fluid temperature: 20°C, including the thermo-chiller's internal pipings or heat exchanger)

*8 Preliminary space volume without main tank capacity. Available for collecting the circulating fluid inside an external piping or for preliminary injection.

*9 The required flow rate when the cooling capacity load is applied at a facility water temperature of 25°C

*10 Weight in the dry state without circulating fluids

Cooling Capacity

HRZ001-L2/002-L2/004-L2/008-L2

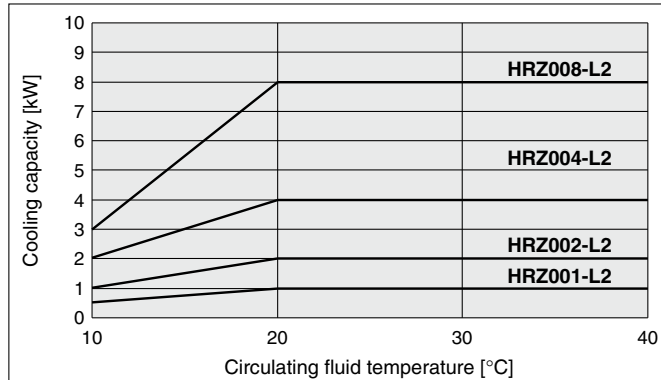

Heating Capacity

HRZ001-L2/002-L2/004-L2/008-L2

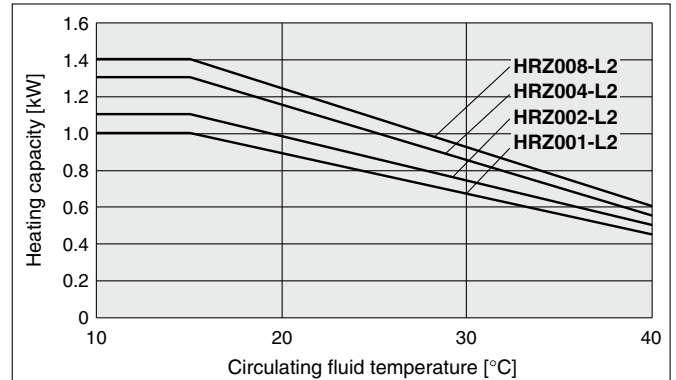

Pump Capacity (Thermo-chiller Outlet)

HRZ001-L2/002-L2/004-L2/008-L2

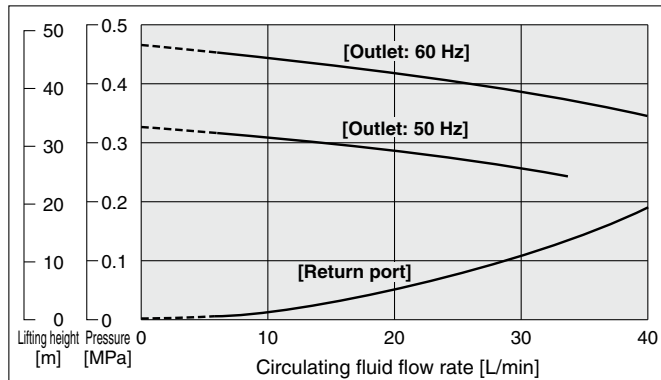

* When the circulating fluid flow is below 6 L/min, the in-built operation stop alarm will be activated. It is not possible to run the equipment. (common for all models)

HRS

HRS-R

HRS090

HRS 100/150

HRS200

HRS090

HRSH

HRSE

HRR

HRL

HRZ

HRZD

HRW

HECR

HEC

HEB

HED

Technical Data

Thermo-chiller Double Inverter Type

HRZ Series



SEMI

The models on this page are to be discontinued as of December 2021. Therefore, we recommend considering an HRZ-F series model instead. For further details on the HRZ-F series, refer [here](#).

How to Order

Double Inverter Type

HRZ010 - W S -

Cooling capacity

Symbol	Cooling capacity
010	10 kW

Circulating fluid type

Symbol	Circulating fluid type	Temperature range setting
Nil	Fluorinated fluids	-20 to 90°C
1	Ethylene glycol aqueous solution	-20 to 90°C
2	Tap water/Deionized water	10 to 60°C

Option (Refer to pages 373 and 374.)

Symbol	Contents
Nil	None
C	Analog communication
D	DeviceNet communication
N	NPT fitting
W	SI unit only
Y*1	DI control kit
Z	Circulating fluid automatic recovery

• When multiple options are combined, indicate symbols in alphabetical order.
*1 Not equipped to the fluorinated fluid type.

Double inverter type

Specifications

Model	HRZ010-WS	HRZ010-W1S	HRZ010-W2S	
Cooling method	Water-cooled refrigeration			
Refrigerant	R404A (HFC)			
Refrigerant charge kg	1.55	1.55	1.55	
Control system	PID control			
Ambient temperature/humidity*1	Temperature: 10 to 35°C, Humidity: 30 to 70%RH			
Circulating fluid system	Circulating fluid*2	<ul style="list-style-type: none"> -20 to 40°C: Fluorinert™ FC-3283/GALDEN® HT135 20 to 90°C: Fluorinert™ FC-40/GALDEN® HT200 	60% ethylene glycol aqueous solution	Tap water, Deionized water
	Temperature range setting*1 °C	-20 to 90		
	Cooling capacity*3 kW	10 (at 20°C)	10 (at 20°C)	9 (at 20°C)
	Heating capacity*3 kW	5.0 (at 20°C)	4.5 (at 20°C)	2.5 (at 20°C)
	Temperature stability*4 °C	±0.1 (In cases when the circulating fluid discharge port and the return port are directly connected)		
	Pump capacity*5 MPa	Max. 0.72 (at 20 L/min)	Max. 0.40 (at 20 L/min)	Max. 0.38 (at 20 L/min)
	Rated flow*6 L/min	20		
	Flow range*7 L/min	10 to 40 (With flow control function by inverter)		
	Main tank capacity*8 L	Approx. 15		
	Sub-tank capacity*9 L	Approx. 16		
Cooling water system	Port size	Rc3/4		
	Fluid contact material	Stainless steel, EPDM, Copper brazing (Heat exchanger), PPS, Silicone, Fluororesin		
	Temperature range °C	10 to 30		10 to 25
	Pressure range MPa	0.3 to 0.7		
	Required flow rate (50/60 Hz)*10 L/min	15/15		
	Port size	Rc1/2		
	Fluid contact material	Stainless steel, EPDM, Copper brazing (Heat exchanger), PPS, Silicone, Brass, NBR		
Electrical system	Power supply	3-phase 200 VAC 50 Hz, 3-phase 200 to 208 VAC 60 Hz Allowable voltage range ±10%		
	Breaker capacity A	30		
	Rated current A	26	25	25
	Alarm	Refer to page 369.		
	Communications	Contact input/output (D-sub 25 pin) and Serial RS-485 (D-sub 25 pin) (Refer to pages 367 and 368.)		
Weight*11 kg	165			
Safety standards*12	UL, CE marking, SEMI (S2, S8, F47), SEMATECH (S2, S8)			

*1 No condensation should be present.

*2 GALDEN® is a registered trademark, belonging to the Solvay Group or its corresponding owner. Fluorinert™ is a trademark of 3M. Dilute pure ethylene glycol with tap water. Additives such as preservatives cannot be used. If tap water or deionized water is used, use water that is compliant with the Water Quality Standards of the Japan Refrigeration and Air Conditioning Industry Association (JRA GL-02-1994/cooling water system - circulation type - make-up water). The minimum electric conductivity of the deionized water used as the fluid should be 0.5 µS/cm (or electric resistivity 2 MΩ·cm at maximum).

*3 ① Facility water temperature: 25°C, ② Circulating fluid flow rate: Values at the rated circulating fluid flow rate. Values common for 50/60 Hz.

*4 Value with a stable load without turbulence in the operating conditions. It may be out of this range when a DI control kit (option Y) is used or in some other operating conditions.

*5 The capacity at the thermo-chiller outlet when the circulating fluid temperature is 20°C

*6 The required flow rate for maintaining the cooling capacity or temperature stability. When used below the rated flow, use the individually sold, "Bypass Piping Set" (Refer to page 370).

*7 May not be able to control with the set value depending on the piping specification in the user side.

*8 Minimum volume required for operating only the thermo-chiller. (Circulating fluid temperature: 20°C, including the thermo-chiller's internal pipings or heat exchanger)

*9 Preliminary space volume without main tank capacity. Available for collecting the circulating fluid inside an external piping or for preliminary injection.

*10 The required flow rate when the cooling capacity load is applied at a facility water temperature of 25°C

*11 Weight in the dry state without circulating fluids

*12 The import of products using R404A as a refrigerant, even if they have a CE mark, into the EU is prohibited.

Cooling Capacity

HRZ010-WS/010-W1S

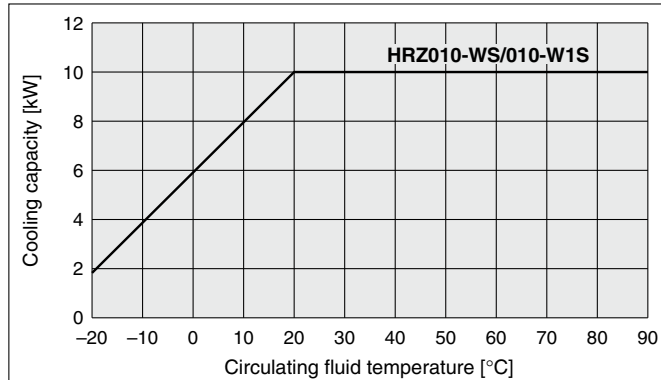

HRZ010-W2S

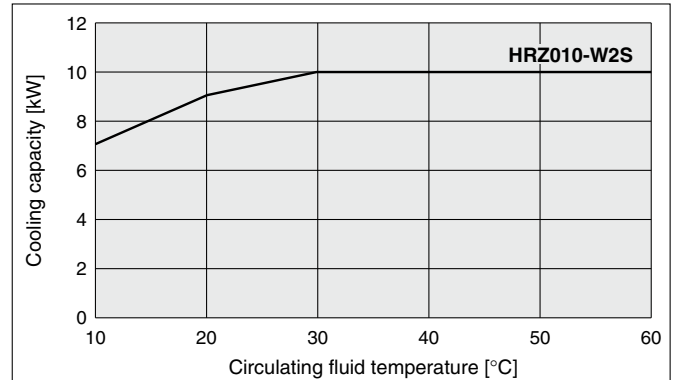

Heating Capacity

HRZ010-WS/010-W1S/010-W2S

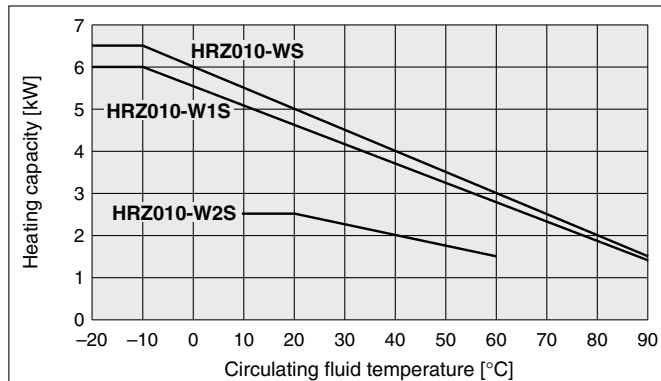

* When pump inverter is operating at frequency of 60 Hz (maximum).

Pump Capacity (Thermo-chiller Outlet)

HRZ010-WS

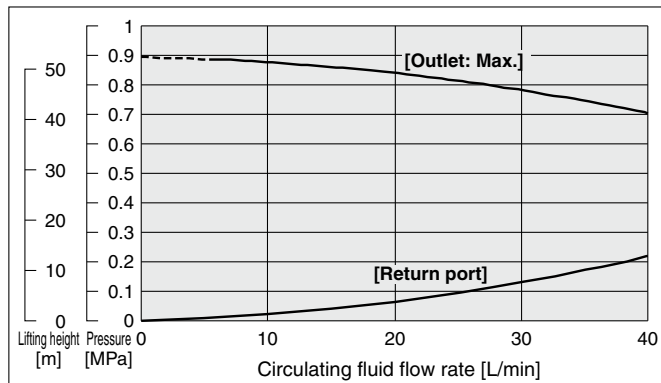

* The pump capacity of the HRZ010-W1S is same as that of the HRZ001-L1 group on page 360.
 * The pump capacity of the HRZ010-W2S is same as on page 362.

HRZ010-W1S

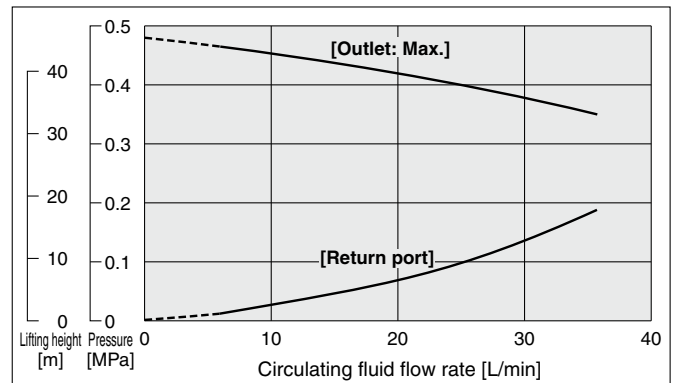

HRZ010-W2S

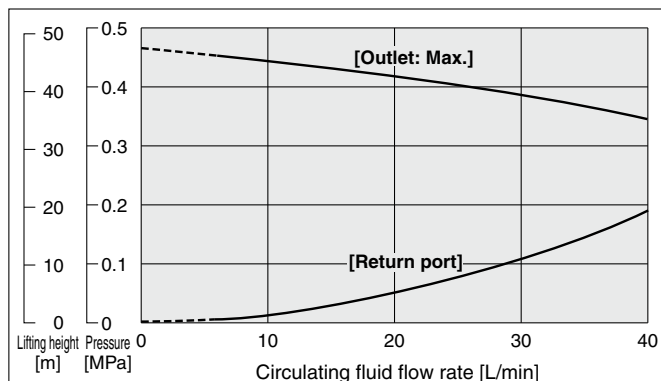

* When the circulating fluid flow is below 6 L/min, the in-built operation stop alarm will be activated. It is not possible to run the equipment. (common for all models)
 * With flow control function by inverter

- HRZ
- HRZ-R
- HRZ090
- HRZ100/150
- HRZ200
- HRSH090
- HRSH
- HRSE
- HRR
- HRL
- HRZ
- HRZD
- HRW
- HECR
- HEC
- HEB
- HED
- Technical Data

HRZ Series Common Specifications

Dimensions

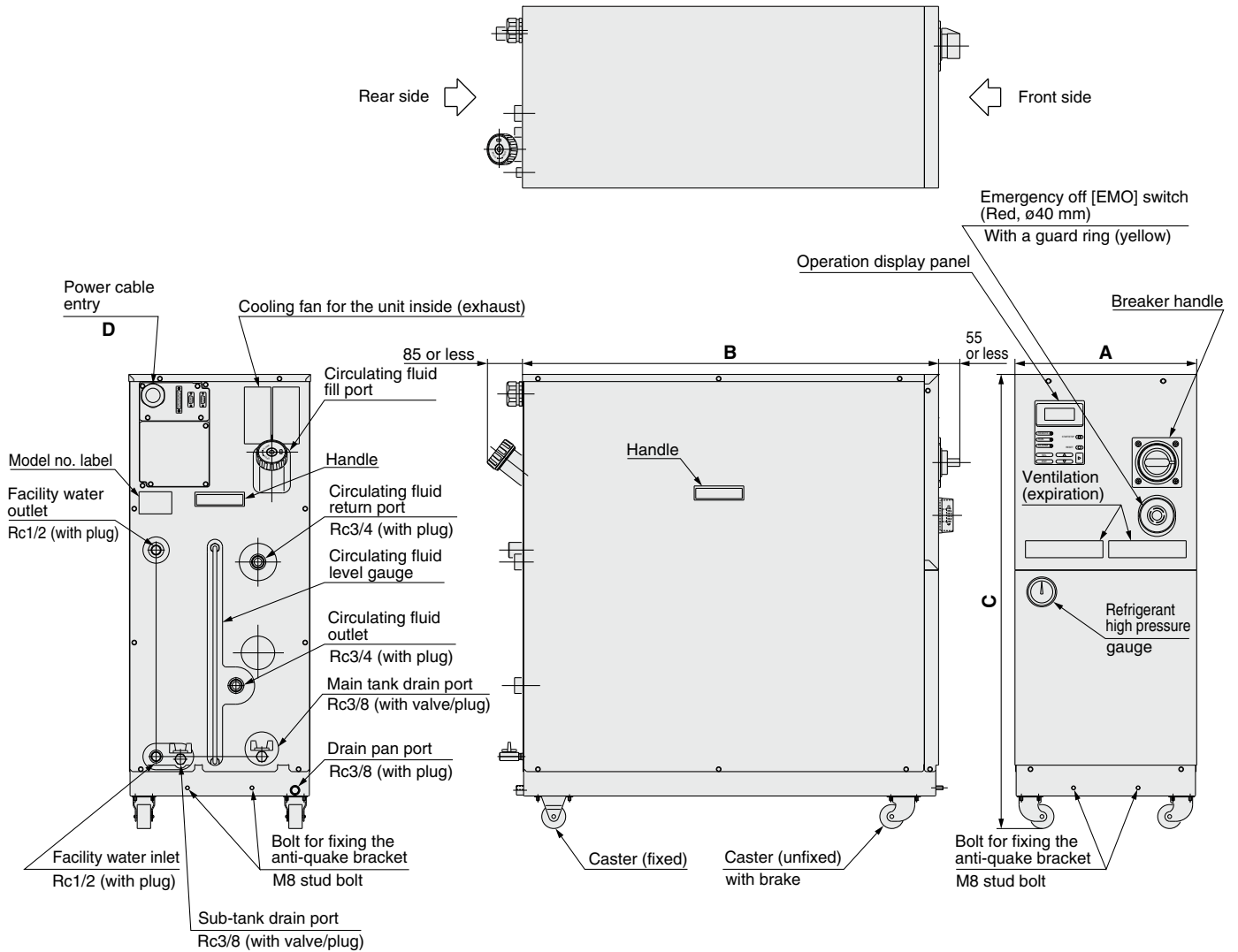

Model			[mm]			
Fluorinated fluid type	Ethylene glycol type	Tap/Deionized water type	A	B	C	D
HRZ001-H HRZ002-H	HRZ001-H1 HRZ002-H1	—	380	870	860	ø18.5 to 20.5
HRZ001-L HRZ002-L, W HRZ004-H HRZ008-H, W HRZ010-WS	HRZ001-L1 HRZ002-L1, W1 HRZ004-H1 HRZ008-H1, W1 HRZ010-W1S	HRZ001-L2 HRZ002-L2 HRZ004-L2 HRZ008-L2 HRZ010-W2S	380	870	950	ø18.5 to 20.5

(Dimensional tolerance of A, B, and C: ±10 mm)

Technical Data
HED
HEB
HEC
HECR
HRW
HRZD
HRZ
HRL
HRR
HRSE
HRSH
HRSH090
HR200
HRS 100/150
HRS090
HRS-R
HRS

Communication Functions (For details, please refer to our "Communication Specifications" information.)

Contact Input/Output

Item	Specifications	
Connector no.	P1 (Refer to page 368 for the connector location.)	
Connector type (on this product's side)	D-sub 25 P type, Female connector	
Fixing bolt size	M2.6 x 0.45	
Input signal	Insulation method	Photocoupler
	Rated input voltage	24 VDC
	Operating voltage range	21.6 VDC to 26.4 VDC
	Rated input current	5 mA TYP
	Input impedance	4.7 kΩ
Open collector output signal	Insulation method	Photocoupler
	Rated load voltage	24 VDC
	Operating load voltage range	21.6 VDC to 26.4 VDC
	Maximum load current	80 mA
	Leakage current	0.1 mA or less
Surge protection	Diode	
Contact output signal (Alarm signal)	Rated load voltage	48 VAC or less/24 VDC or less
	Maximum load current	500 mA AC/DC (Resistance load)
Contact output signal (EMO signal)	Rated load voltage	48 VAC or less/24 VDC or less
	Maximum load current	800 mA AC/DC (Resistance load/Inductive load)

Circuit diagram

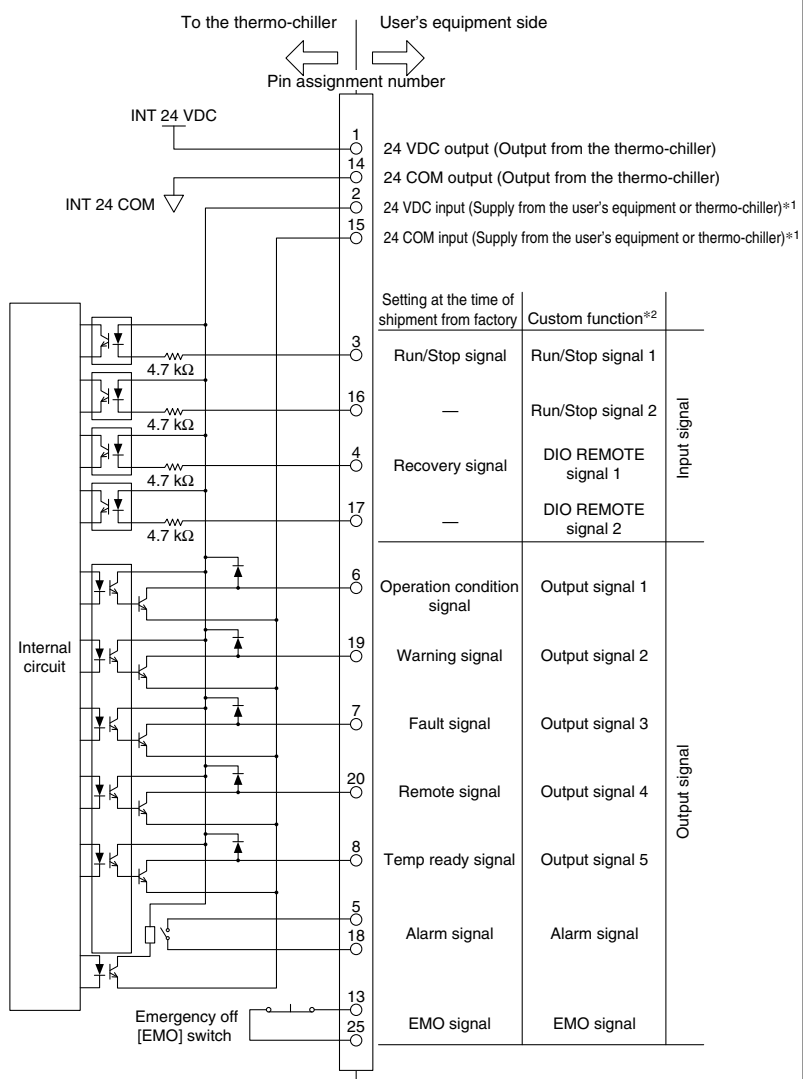

*1 When using the power supply of the thermo-chiller, short circuit pins 1 and 2 and pins 14 and 15 respectively.

When using the power supply of the user's equipment, connect the lead wires to pins 2 and 15 and short circuit pins 14 and 15. Incorrect connections may cause a malfunction.

*2 The custom function is equipped for contact input/output. Using the custom function enables the user to set the signal type for contact input/output or pin assignment numbers. For details, please refer to the "Communication Specifications" information.

Serial RS-485

The serial RS-485 enables the following items to be written and read out.

<Writing>

Run/Stop

Circulating fluid temperature setting

Circulating fluid automatic recovery start/stop*1

<Readout>

Circulating fluid present temperature

Circulating fluid flow

Circulating fluid discharge pressure

Circulating fluid electric resistivity*2

Alarm occurrence information

Status (operating condition) information

*1 Only when the circulating fluid automatic recovery function (option Z) is selected.

*2 Only when the DI control kit (option Y) is selected.

Item	Specifications
Connector no.	P2
Connector type (on this product's side)	D-sub 9 P type, Female connector
Fixing bolt size	M2.6 x 0.45
Standards	EIA RS485
Protocol	Modicon Modbus
Circuit diagram	

Connector Location

P3: Not used for the maintenance purpose port
D-sub 9 (Male receptacle)

P2: Serial RS-485
D-sub 9 (Female receptacle)

P1: Contact input/output
D-sub 25 (Female receptacle)

Power cable entry

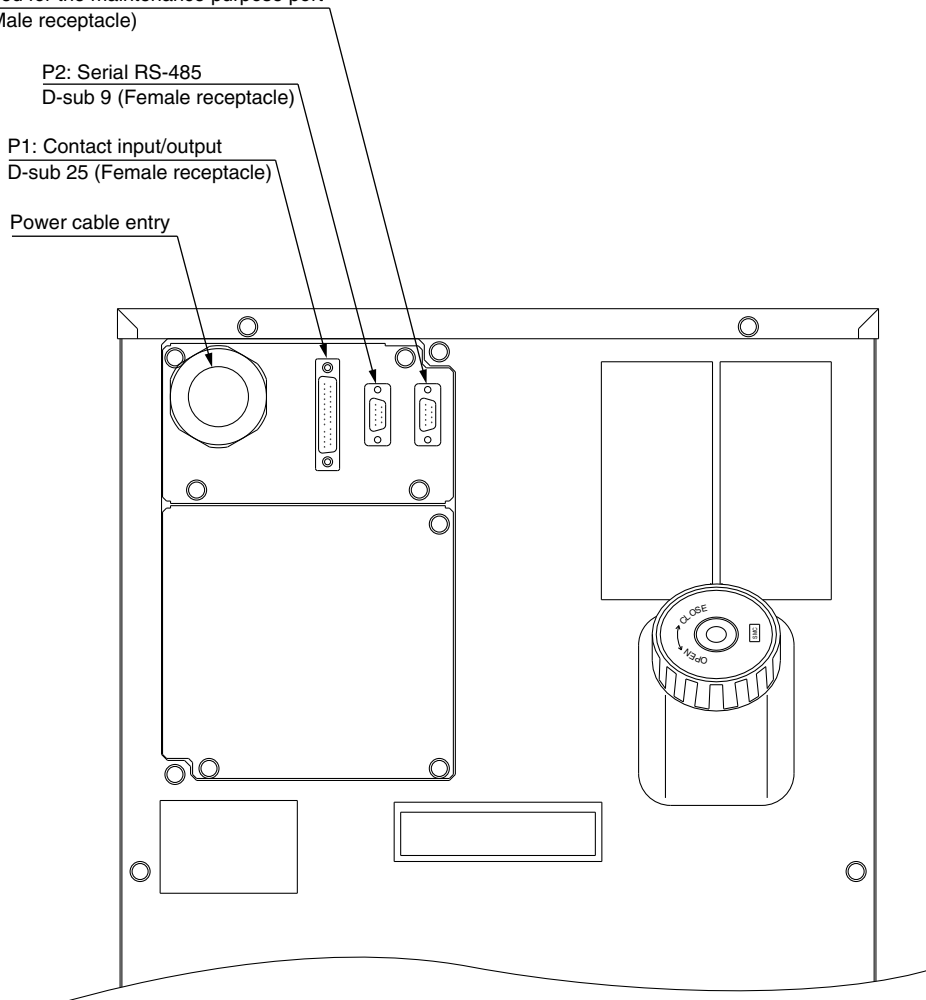

Rear side

- HRZ
- HRZD
- HRW
- HECR
- HEC
- HEB
- HED
- HRSH
- HRSE
- HRR
- HRL
- HRZ
- HRZD
- HRW
- HECR
- HEC
- HEB
- HED
- Technical Data

Operation Display Panel

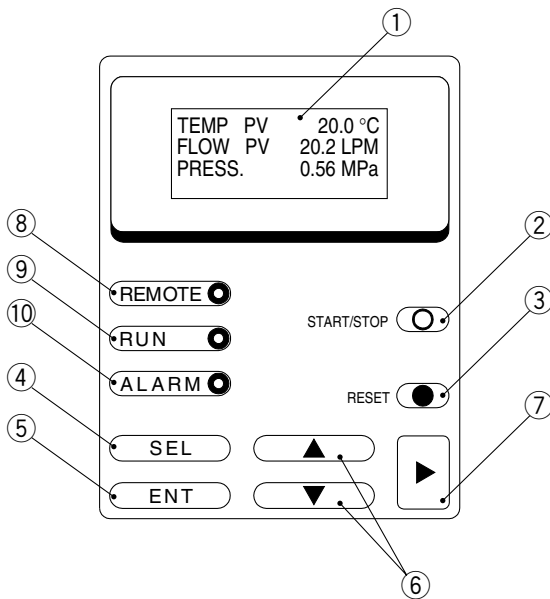

No.	Description	Function
①	LCD	Operating condition of this unit/Circulating fluid discharge temperature/Circulating fluid flow/Circulating fluid discharge pressure/Setting value/Alarm message, etc. are displayed.
②	[START/STOP] key	Starts/Stops the operation.
③	[RESET] key	Stops the alarm buzzing. Resets the alarm.
④	[SEL] key	Switches the display.
⑤	[ENT] key	Decides the settings.
⑥	[▲] [▼] key	Moves the cursor and changes the setting values.
⑦	[▶] key	Moves the cursor.
⑧	[REMOTE] lamp	Lights up when the unit is in the remote status.
⑨	[RUN] lamp	Lights up when the unit is in the operating status.
⑩	[ALARM] lamp	Lights up when the unit is alarming.

Alarm

This unit can display 27 kinds of alarm messages as standard. Also, it can read out the serial RS-485 communication.

Alarm code	Alarm message	Operation status	Main reason
01	Water Leak Detect FLT	Stop	Liquid deposits in the base of this unit.
02	Incorrect Phase Error FLT	Stop	The power supply to this unit is incorrect.
03	RFGT High Press FLT	Stop	Pressure in the refrigeration circuit has exceeded the limitation.
04	CPRSR Overheat FLT	Stop	Temperature inside the compressor has increased.
05	Reservoir Low Level FLT	Stop	The amount of circulating fluid is running low.
06	Reservoir Low Level WRN	Continue	The amount of circulating fluid is running low.
07	Reservoir High Level WRN	Continue	Filling the circulating fluid too much.
08	Temp. Fuse Cutout FLT	Stop	Temperature of the circulating fluid tank is raised.
09	Reservoir High Temp. FLT	Stop	Temperature of the circulating fluid has exceeded the limitation.
11	Reservoir High Temp. WRN	Continue	Temperature of the circulating fluid has exceeded the limitation set by user.
12	Return Low Flow FLT	Stop	The circulating fluid flow has gone below 6 L/min.
13	Return Low Flow WRN	Continue	The circulating fluid flow has gone below the limitation set by user.
14	Heater Breaker Trip FLT	Stop	Protection device for the electric circuit of the heater is activated.
15	Pump Breaker Trip FLT	Stop	Protection device for the electric circuit of the circulating pump is activated.
16	CPRSR Breaker Trip FLT	Stop	Protection device for the electric circuit of the compressor is activated.
17	Interlock Fuse Cutout FLT	Stop	Overcurrent is flown to the control circuit.
18*1, *2	DC Power Fuse Cutout WRN	Continue	Overcurrent has flowed to the solenoid valve.
19	FAN Motor Stop WRN	Continue	Cooling fan inside the compressor has stopped.
20	Internal Pump Time Out WRN	Continue	The internal pump continuously run for more than a certain period of time.
21	Controller Error FLT	Stop	The error occurred in the control systems.
22	Memory Data Error FLT	Stop	The data stored in the controller of this unit went wrong.
23	Communication Error WRN	Continue	The serial communications between this unit and user's system has been suspended.
24*2	DI Low Level WRN	Continue	DI level of the circulating fluid has gone below the limitation set by user.
25*3	Pump Inverter Error FLT	Stop	An error has occurred in the inverter for the circulating pump.
26*4	DNET Comm. Error WRN	Continue	The DeviceNet communications between this unit and user's system has been suspended.
27*4	DNET Comm. Error FLT	Stop	An error has occurred in the DeviceNet communication system of this unit.
28*3	CPRSR INV Error FLT	Stop	An error has occurred in the inverter for the compressor.

*1 Only for the circulating fluid automatic recovery specification (Option symbol Z)

*2 Only for the DI control kit specification (Option symbol Y)

*3 HRZ010-W□S only

*4 Only for the DeviceNet communication specification (Option symbol D)

HRZ Series Optional Accessories

① Bypass Piping Set

* Necessary to be fitted by user.

When the circulating fluid goes below the rated flow, cooling capacity will be reduced and the temperature stability will be badly affected. In such a case, use the bypass piping set.

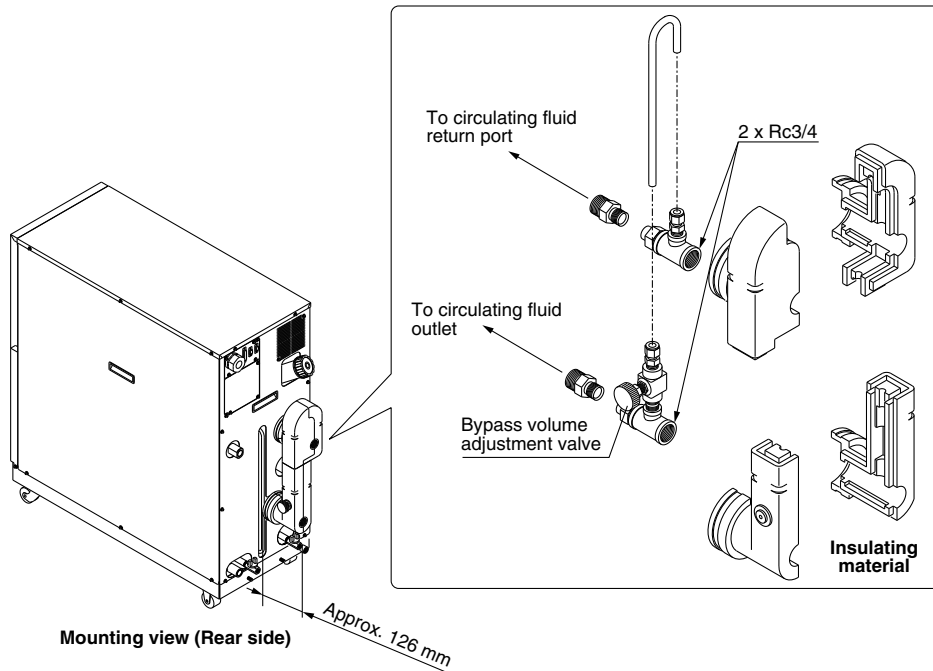

Part no.	Applicable model
HRZ-BP001	HRZ001-H/HRZ001-H1 HRZ002-H/HRZ002-H1
	HRZ001-L/HRZ001-L1 HRZ001-L2 HRZ002-L/HRZ002-L1 HRZ002-L2 HRZ004-L2 HRZ008-L2
HRZ-BP002	HRZ004-H/HRZ004-H1 HRZ008-H/HRZ008-H1 HRZ002-W/HRZ002-W1 HRZ008-W/HRZ008-W1 HRZ010-WS HRZ010-W1S HRZ010-W2S

② Anti-quake Bracket

Bracket for earthquakes
Prepare the anchor bolts (M12) which are suited to the floor material by user.

Part no.	Applicable model
HRZ-TK002	HRZ001-L□/HRZ002-L□/HRZ008-L2 HRZ001-H□/HRZ002-H□ HRZ004-H□/HRZ008-H□ HRZ002-W□/HRZ008-W□/HRZ010-W□S

- * 2 pieces per set (for 1 unit) (HRZ-TK002)
- * Anti-quake bracket is attached as standard. (HRZ008-L, HRZ008-L1)

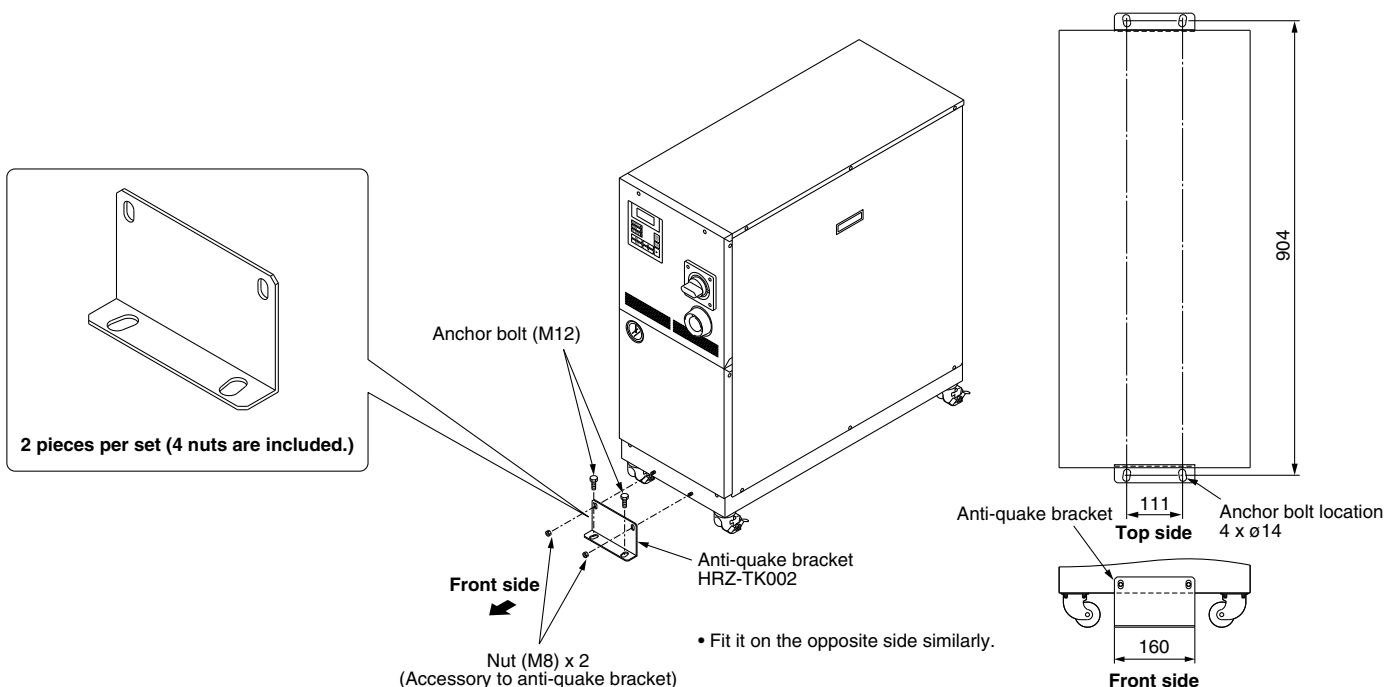

HRZ Series

③ 4-Port Manifold

4-branching the circulating fluid enables 4 temperature controls at the maximum with the 1 unit thermo-chiller.

Part no.	Applicable model
HRZ-MA001	Common for all models

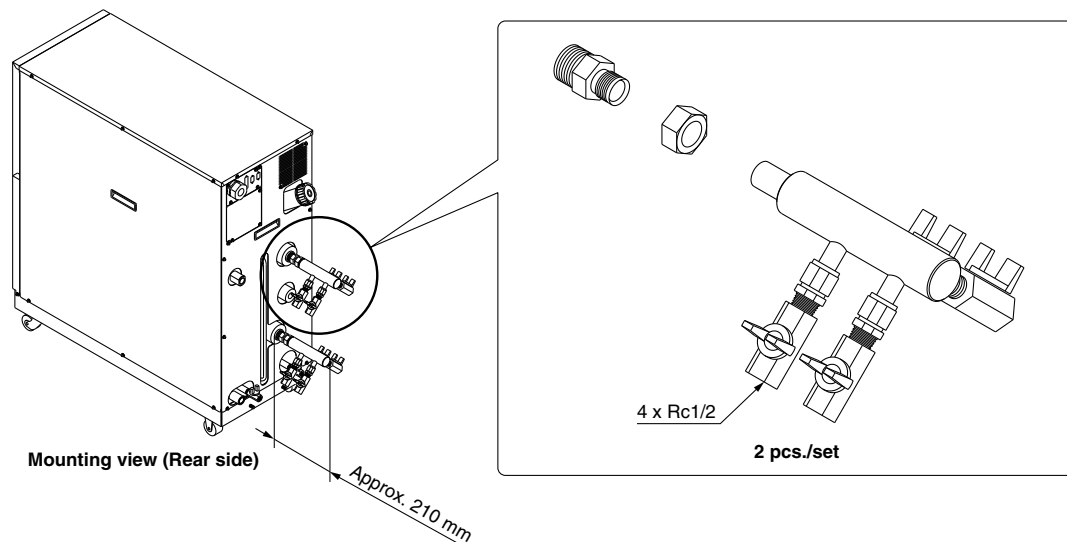

④ DI Filter

This is the ion replacement resin to maintain the electric resistivity of the circulating fluid.

Users who selected the DI control kit (option Y) need to purchase the DI filter separately.

Part no.	Applicable model
HRZ-DF001	Common for all models which can select the DI control kit. (option Y)

* The DI filters are consumable. Depending on the status (electric resistivity set value, circulating fluid temperature, piping volume, etc.), product life cycles will vary accordingly.

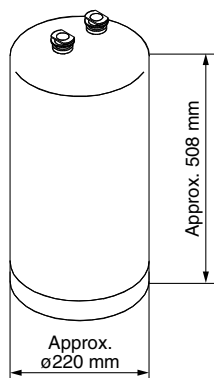

Weight: Approx. 20 kg

⑤ Insulating Material for DI Filter

When the DI filter is used at a high-temperature, we recommend that you use this insulating material to protect the radiated heat from the DI filter or possible burns. When the DI filter is used at a low-temperature, we also recommend that you use this to prevent heat absorption from the DI filter and to avoid forming condensation.

Part no.	Applicable model
HRZ-DF002	Common for all models which can select the DI control kit. (option Y)

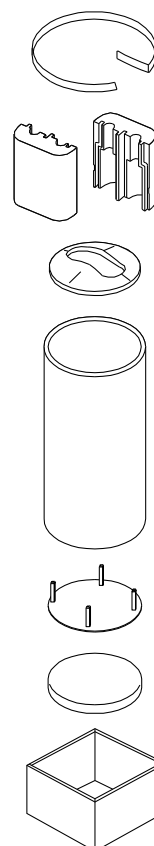

⑥ 60% Ethylene Glycol Aqueous Solution

This solution can be used as a circulating fluid for ethylene glycol-type thermo-chillers. (Capacity: 10 L)

Part no.	Applicable model
HRZ-BR001	Common for all ethylene glycol-type models

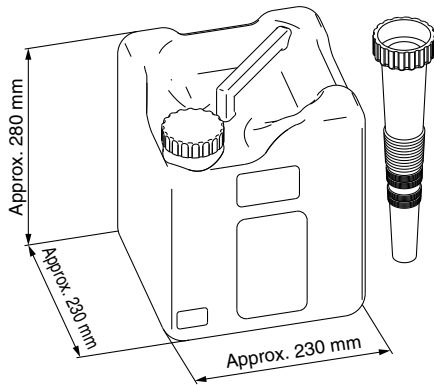

⑦ Concentration Meter

This meter can be used to control the condensation of ethylene glycol solution regularly.

Part no.	Applicable model
HRZ-BR002	Common for all ethylene glycol-type models

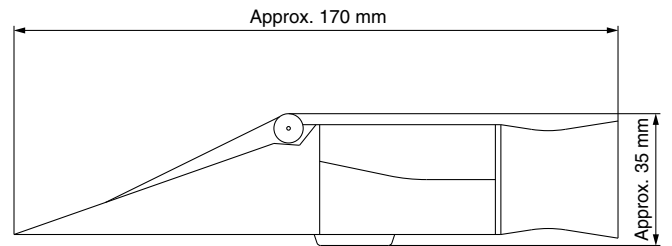

HRS

HRS-R

HRS090

HRS
100/150

HRS200

HRS090

HRSH

HRSE

HRR

HRL

HRZ

HRZD

HRW

HECR

HEC

HEB

HED

Technical
Data

HRZ Series Options

* Options have to be selected when ordering the thermo-chiller. It is not possible to add them after purchasing the unit.

C Option symbol Analog Communication

HRZ - - C
Analog communication

In addition to the standard contact input/output signal communication and the serial RS-485 communication, analog communication function can be added.

The analog communication function enables to write and read out the following items.

<Writing>	<Readout>
Circulating fluid temperature setting	Circulating fluid present temperature
	Electric resistivity* ¹

*1 Only when the DI control kit (option Y) is selected.

Scaling voltage - circulating fluid temperature can be set arbitrarily by user.

For details, please refer to our "Communication Specifications" information.

N Option symbol NPT Fitting

HRZ - - N
NPT fitting

An adapter is included to change the connection parts of circulating fluid piping and facility water piping to NPT thread type. The adapter must be installed by user.

Y Option symbol DI Control Kit

HRZ - - Y
DI control kit

Select this option if you want to maintain the electric resistance ratio (DI level) of the circulating fluid at a certain level. However, some components have to be fitted by user. For details, refer to specification table for this option.

Please note that this is not applicable to the fluorinated liquid type.

Applicable model		HRZ00□-L1-Y HRZ00□-H1-Y HRZ00□-W1-Y HRZ010-W1S-Y	HRZ00□-L2-Y HRZ010-W2S-Y
Allowable circulating fluid	—	60% ethylene glycol aqueous solution	Deionized water
DI level display range	MΩ-cm	0 to 20	
DI level set range	MΩ-cm	0 to 2.0* ¹	
DI level reduction alarm set range	MΩ-cm	0 to 2.0	

*1 The DI filter is needed to control the DI level. (SMC Part No.: HRZ-DF001)
Please purchase additionally because the DI filter is not included in this option. Also, if necessary, additionally purchase the insulating material for the DI filter. (SMC Part No.: HRZ-DF002)

- * Install the DI filter outside the thermo-chiller for piping. Secure the space for installing the DI filter on the rear side of the thermo-chiller.
- * It may go outside of the temperature stability range of $\pm 0.1^{\circ}\text{C}$ when this option is used in some operating conditions.

D Option symbol DeviceNet Communication

HRZ - - D
DeviceNet communication

DeviceNet™
■ Trademark
DeviceNet™ is a trademark of ODVA.

In addition to the standard contact input/output signal communication and the serial RS-485 communication, DeviceNet function can be added. DeviceNet function enables to write and read out the following items.

<Writing>	<Readout>
Run/Stop	Circulating fluid present temperature
Circulating fluid temperature setting	Circulating fluid flow
Circulating fluid automatic recovery start/stop* ¹	Circulating fluid discharge pressure
	Electric resistivity* ²
	Alarm occurrence information
	Status (operating condition) information

*1 Only when the circulating fluid automatic recovery function (option Z) is selected.

*2 Only when the DI control kit (option Y) is selected.

For details, please refer to our "Communication Specifications" information.

W Option symbol SI Unit Only

HRZ - - W
SI unit only

The circulating fluid temperature and pressure are displayed in SI units [MPa/°C] only. If this option is not selected, a product with a unit selection function will be provided by default.
* No change in external dimensions

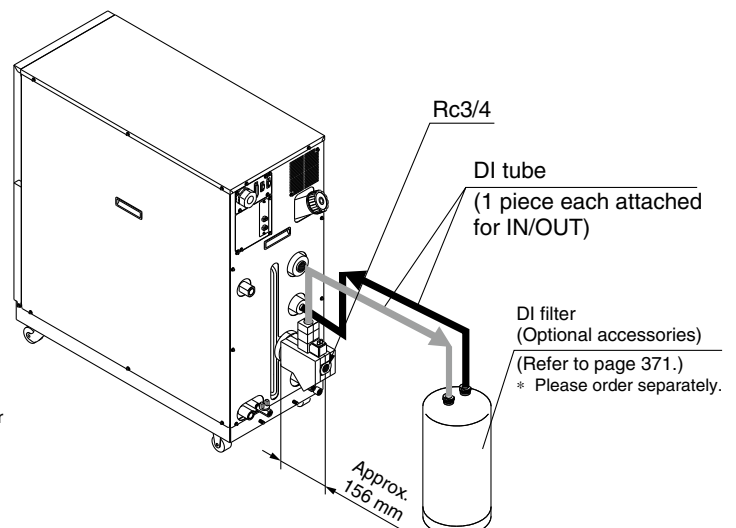

Z Option symbol**Circulating Fluid Automatic Recovery**

HRZ - - **Z**

Circulating fluid
automatic recovery

Select this option for users who want to use the circulating fluid automatic recovery function.

The automatic recovery function is a device which can recover the circulating fluid inside pipings into a sub-tank of the thermo-chiller by the external communication or operating display panel. Some components need to be fitted by user. For details, please refer to the "Product Specifications" information for these options.

Applicable model	HRZ001-H-Z HRZ001-H1-Z HRZ002-H-Z HRZ002-H1-Z		HRZ001-L-Z HRZ002-L-Z HRZ004-H-Z HRZ008-H-Z HRZ001-L2-Z HRZ004-L2-Z HRZ002-W-Z HRZ008-W-Z HRZ010-WS-Z HRZ010-W2S-Z		HRZ001-L1-Z HRZ002-L1-Z HRZ004-H1-Z HRZ008-H1-Z HRZ002-L2-Z HRZ008-L2-Z HRZ002-W1-Z HRZ008-W1-Z HRZ010-W1S-Z	
	Circulating fluid recoverable volume*1	L	15	16		
Purge gas	—	Nitrogen gas				
Purge gas supply port	—	Self-align fitting for O.D. ø8*2				
Purge gas supply pressure	MPa	0.4 to 0.7				
Purge gas filtration	μm	0.01 or less				
Regulator set pressure	MPa	0.15 to 0.3*3				
Recoverable circulating fluid temperature	°C	10 to 30				
Recovery start/stop	—	Start: External communication*4 or operation display panel/Stop: Automatic				
Timeout error	sec	Timer from recovery start to completion Stops recovering when the timer turns to set time. Possible set range: 60 to 300, at the time of shipping from the factory: 300				
Height difference with the user system side	m	10 or less				

*1 This is the space volume of the sub-tank when the liquid level of the circulating fluid is within the specification. Guideline of the recovery volume is 80% of the circulating fluid recoverable volume.

*2 Before piping, clean inside the pipings with air blow, etc. Use the piping with no dust generation by purge gas. When using resin tube, where necessary, use insert fittings, etc. in order not to deform the tubings when connecting to self-align fittings.

*3 At the time of shipping from factory, it is set to 0.2 MPa.

*4 For details, please refer to our "Communication Specifications" information.

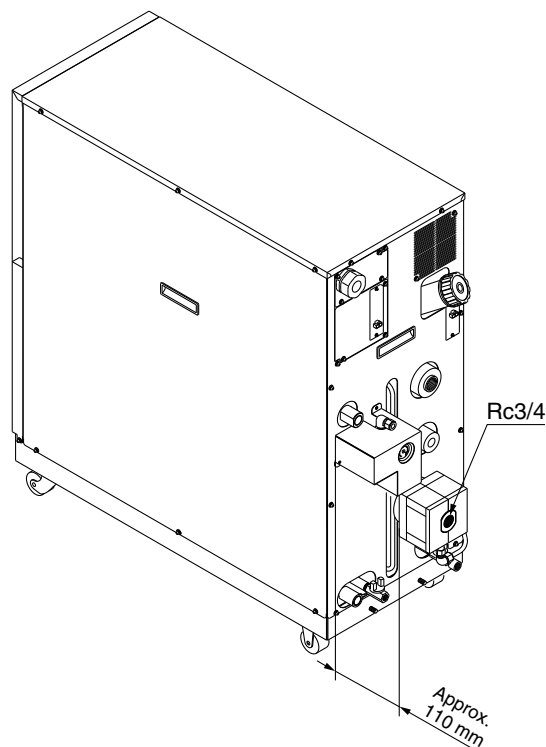



HRZ Series

Specific Product Precautions 1

Be sure to read this before handling the products. Refer to page 513 for safety instructions and pages 514 to 517 for temperature control equipment precautions.

Design

Warning

- 1. This catalog shows the specifications of a single unit.**
 - For details, please refer to our "Product Specifications" and thoroughly consider the adaptability between the user's system and this unit.
 - Although a protection circuit as a single unit is installed, the user is requested to carry out a safety design for the whole system.

Selection

Caution

1. Model selection

In order to select the correct thermo-chiller model, the amount of thermal generation from the user's system, the operating circulating fluid, and its circulating flow are required. Select a model, by referring to the guideline to model selection on page 351.

2. Option selection

Options have to be selected when ordering the thermo-chiller. It is not possible to add them after purchasing the unit.

Handling

Warning

1. Thoroughly read the operation manual.

Read the operation manual completely before operation, and keep the manual where it can be referred to as necessary.

Operating Environment/Storage Environment

Caution

1. Do not use in the following environment because it will lead to a breakdown.

- Environment like written in "Temperature Control Equipment Precautions."
- Locations where spatter will adhere to when welding.
- Locations where it is likely that the leakage of flammable gas may occur.
- Locations where the ambient temperature exceeds the limits as mentioned below.
 - During operation 10°C to 35°C
 - During storage 0°C to 50°C (but as long as water or circulating fluid are not left inside the pipings)
- Locations where the ambient relative humidity exceeds the limit as mentioned below.
 - During operation 30% to 70%
 - During storage 15% to 85%
- (Inside the operation facilities) locations where there is not sufficient space for maintenance.
- In locations where the ambient pressure exceeds the atmospheric pressure.

2. The Thermo-chiller does not have clean room specification. It generates dust from the pump inside the unit and the cooling fan for the unit inside.

Circulating Fluid

Caution

- 1. Avoid oil or other foreign matter entering the circulating fluid.**

Circulating Fluid

- 2. Use ethylene glycol that does not contain additives such as preservatives.**
- 3. The condensation of ethylene glycol aqueous solution must be 60% or less. If the density is too high, the pump will be overloaded, resulting in occurrence of "Pump Breaker Trip FLT." Also, if the density is too low, the unit will freeze at lower temperatures, resulting in product failure.**
- 4. Avoid water moisture entering the fluorinated fluid. Otherwise, the unit will freeze, resulting in product failure.**
- 5. Use tap water (including for diluting ethylene glycol aqueous solution) which must meet the water quality standards as mentioned below.**

Tap Water (as Circulating Water) Quality Standards

The Japan Refrigeration and Air Conditioning Industry Association
JRA GL-02-1994 "Cooling water system – Circulating type – Supply water"

	Item	Unit	Standard value	Influence	
				Corrosion	Scale generation
Standard item	pH (at 25°C)	—	6.0 to 8.0	○	○
	Electric conductivity (25°C)	[μS/cm]	100*1 to 300*1	○	○
	Chloride ion (Cl ⁻)	[mg/L]	50 or less	○	
	Sulfuric acid ion (SO ₄ ²⁻)	[mg/L]	50 or less	○	
	Acid consumption amount (at pH4.8)	[mg/L]	50 or less		○
	Total hardness	[mg/L]	70 or less		○
	Calcium hardness (CaCO ₃)	[mg/L]	50 or less		○
Reference item	Ionic state silica (SiO ₂)	[mg/L]	30 or less		○
	Iron (Fe)	[mg/L]	0.3 or less	○	○
	Copper (Cu)	[mg/L]	0.1 or less	○	
	Sulfide ion (S ₂ ⁻)	[mg/L]	Should not be detected.	○	
	Ammonium ion (NH ₄ ⁺)	[mg/L]	0.1 or less	○	
	Residual chlorine (Cl)	[mg/L]	0.3 or less	○	
	Free carbon (CO ₂)	[mg/L]	4.0 or less	○	

*1 In the case of [MΩ·cm], it will be 0.003 to 0.01.

○: Factors that have an effect on corrosion or scale generation.

• Even if the water quality standards are met, complete prevention of corrosion is not guaranteed.

HRZ

HRZ-R

HRZ090

HRZ100/150

HRZ200

HRZ090

HRZSH

HRZSE

HRZ

HRZL

HRZ

HRZD

HRZ

HRZ

HRZ

HRZ

HRZ

HRZ

HRZ

HRZ

HRZ



HRZ Series

Specific Product Precautions 2

Be sure to read this before handling the products. Refer to page 513 for safety instructions and pages 514 to 517 for temperature control equipment precautions.

Facility Water Supply

Warning

<Water-cooled refrigeration>

1. The water-cooled refrigeration type thermo-chiller radiates heat to the facility water.

Prepare the facility water system that satisfies the facility water specifications below.

2. When using tap water as facility water, use tap water that conforms to the appropriate water quality standards.

Use tap water that conforms to the standards shown below.

<Tap Water (as Facility Water) Quality Standards>

The Japan Refrigeration and Air Conditioning Industry Association
JRA GL-02-1994 "Cooling water system – Circulation type – Circulating water"

	Item	Unit	Standard value	Influence	
				Corrosion	Scale generation
Standard item	pH (at 25°C)	—	6.5 to 8.2	○	○
	Electric conductivity (25°C)	[μS/cm]	100*1 to 800*1	○	○
	Chloride ion (Cl ⁻)	[mg/L]	200 or less	○	○
	Sulfuric acid ion (SO ₄ ²⁻)	[mg/L]	200 or less	○	○
	Acid consumption amount (at pH4.8)	[mg/L]	100 or less	○	○
	Total hardness	[mg/L]	200 or less	○	○
	Calcium hardness (CaCO ₃)	[mg/L]	150 or less	○	○
Reference item	Ionic state silica (SiO ₂)	[mg/L]	50 or less	○	○
	Iron (Fe)	[mg/L]	1.0 or less	○	○
	Copper (Cu)	[mg/L]	0.3 or less	○	○
	Sulfide ion (S ₂ ⁻)	[mg/L]	Should not be detected.	○	○
	Ammonium ion (NH ₄ ⁺)	[mg/L]	1.0 or less	○	○
	Residual chlorine (Cl)	[mg/L]	0.3 or less	○	○
	Free carbon (CO ₂)	[mg/L]	4.0 or less	○	○

*1 In the case of [MΩ·cm], it will be 0.001 to 0.01.

- : Factors that have an effect on corrosion or scale generation.
- Even if the water quality standards are met, complete prevention of corrosion is not guaranteed.

3. Set the supply pressure between 0.3 to 0.7 MPa. Ensure a pressure difference at the facility water inlet/outlet of 0.3 MPa or more.

If the supply pressure is high, it will cause water leakage. If the supply pressure and pressure difference at the facility water inlet/outlet is low, it will cause an insufficient flow rate of the facility water, and poor temperature control.

Transportation/Carriage/Movement

Warning

1. Transporting with forklift

1. It is not possible to hang this product.
2. The fork insertion position is either on the left side face or right side face of the unit. Be careful not to bump the fork against a caster or level foot and be sure to put through the fork to the opposite side.
3. Be careful not to bump the fork to the cover panel or piping ports.

2. Transporting with casters

1. This product is heavy and should be moved by at least two people.
2. Do not grip the pipings on the rear side or the handles of the panel.

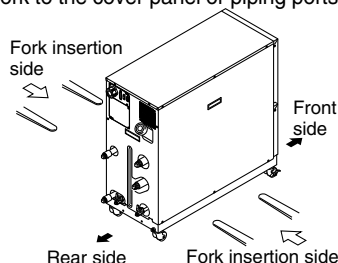

Mounting/Installation

Caution

1. Avoid using this product outdoors.
2. Install on a rigid floor which can withstand this product's weight.
3. Install a suitable anchor bolt for the anti-quake bracket taking into consideration the user's floor material.
4. Avoid placing heavy objects on this product.

Piping

Caution

1. Regarding the circulating fluid and facility water pipings, consider carefully the suitability for temperature, circulating fluid and facility water.

If the operating performance specifications are regularly exceeded, the pipings may burst during operation.

Also, the use of corrosive materials such as aluminum or iron for fluid contact parts, such as piping, may not only lead to clogging or leakage in the circulating fluid and facility water circuits but also refrigerant leakage and other unexpected problems. Provide protection against corrosion when you use the product.

2. The surface of the circulating fluid pipings should be covered with the insulating materials which can effectively confine the heat.

Absorbing the heat from the surface of pipings may reduce the cooling capacity performance and the heating capacity may be shortened due to heat radiation.

3. When using fluorinated liquid as the circulating fluid, do not use pipe tape.

Liquid leakage may occur around the pipe tape. For sealant, we recommend that you use the following sealant: SMC Part No., HRZ-S0003 (Silicone sealant)

4. For the circulating fluid pipings, use clean pipings which have no dust, oil or water moisture inside the pipings, and blow with air prior to undertaking any piping works.

If any dust, oil or water moisture enters the circulating fluid circuit, inferior cooling performance or equipment failure due to frozen water may occur, resulting in bubbles in the circulating fluid inside the tank.

5. The reciprocating total volume of the circulating fluid pipings must be less than the volume of the sub-tank.

Otherwise, when the equipment is stopped, the in-built alarm may activate or the circulating fluid may leak from the tank. Refer to the specifications table for the sub-tank volume.

6. Select the circulating fluid pipings which can exceed the required rated flow.

For the rated flow, refer to the pump capacity table.

7. For the circulating fluid piping connection, install a drain pan just in case the circulating fluid may leak.

8. Do not return the circulating fluid to the unit by installing a pump in the user system.

9. The facility water flow rate is adjusted automatically according to the operating conditions.

In addition, the facility water return temperature is 60°C at maximum.

Electrical Wiring

Caution

1. Power supply and signal cable should be prepared by user.

2. Provide a stable power supply which is not affected by surge or distortion.

If the voltage increase ratio (dV/dt) at the zero cross should exceed 40 V/200 μsec., it may result in malfunction.

