

Pin Cylinder: Single Acting, Spring Return

New

RoHS

ø4, ø6, ø10, ø16

A short-stroke miniature cylinder with a shorter overall length

The installation space can be significantly reduced because this cylinder can be recessed directly into a machine or installed on a panel. Thus, the machine can be made more compact.



Application Examples

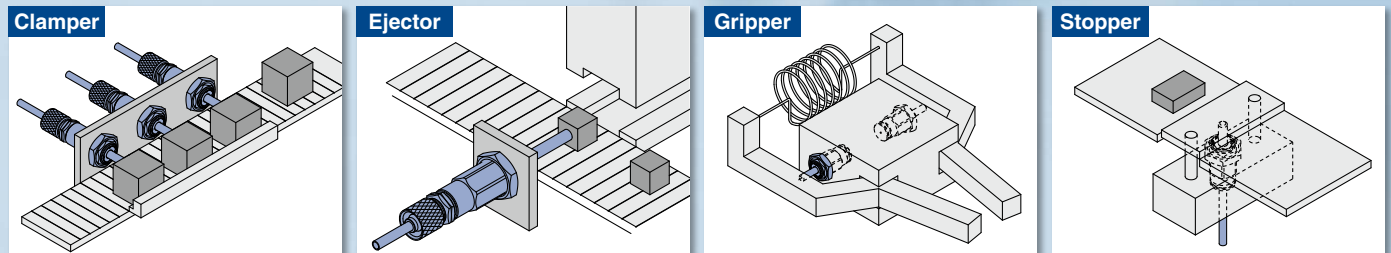

Rod end cap can now be ordered with the cylinder.

It is not necessary to order a rod end cap for the applicable cylinder separately.

Example CJPS16-15Z-T

Rod end cap		Without cap	
Nil			
T	Rod end cap (Flat type)		
U	Rod end cap (Round type)		

One-touch fitting can be connected. (Panel mount type)

ø2 One-touch fitting, miniature fitting, and speed controller can be connected.



Applicable for the change of the rod end shape (-XA□)

(Simple Specials) → p. 6

CJP Series

16 mm bore size is now available.

(Changed from the existing product: 15 mm)

Specifications and dimensions are the same as the existing product.



CAT.ES20-265A

Pin Cylinder: Single Acting, Spring Return

CJP Series

ø4, ø6, ø10, ø16



How to Order

Embedded type

Panel mount type

CJP B 16 - 15 H4 Z - T -

Pin cylinder

Mounting

B	Panel mount type
S	Embedded type

Panel mount type Embedded type

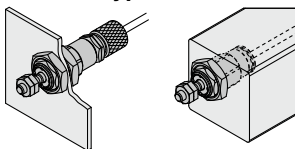

Bore size

4	4 mm
6	6 mm
10	10 mm
16	16 mm

Standard stroke [mm]

ø4, ø6, ø10, ø16	5, 10, 15
-------------------------	-----------

• Made to order (ø6 to ø16)

* For details, refer to the table below.

• Rod end cap

Nil	Without cap		
T	Rod end cap (Flat type)	Rod end cap (Flat type)	
U	Rod end cap (Round type)	Rod end cap (Round type)	

* Rod end cap is included in the same package. Use the rod end nut of the standard cylinder to tighten the rod end cap.
* Applicable for rod end with thread type

• Rod end thread

Nil	With thread
B	Without thread

• Hose nipple

(Hose nipple is not attached to the embedded type.)

Nil	Without hose nipple
H4	For ø4/ø2.5 tubing
H6	For ø6/ø4 tubing

* For details, refer to page 8.

Symbol

Single acting, Spring return

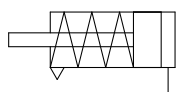

Made to Order (ø6 to ø16)
(For details, refer to pages 6 and 7.)

Symbol	Specifications
XA □	Change of rod end shape
XC17	Pin cylinder with rod quenched
XC22	Fluororubber seals

Moisture Control Tube IDK Series



When operating an actuator with a small diameter and a short stroke at a high frequency, dew condensation (water droplets) may occur inside the piping depending on the conditions. Simply connecting the moisture control tube to the actuator will prevent dew condensation from occurring. For details, refer to the [Web Catalog](#).

Specifications

Action	Single acting, Spring return	
Maximum operating pressure	0.7 MPa	
Minimum operating pressure	ø4	0.3 MPa
	ø6	0.2 MPa
	ø10, ø16	0.15 MPa
Proof pressure	1 MPa	
Ambient and fluid temperatures	-10 to 70°C (No freezing)	
Lubrication	Not required (Non-lube)	
Piston speed	50 to 500 mm/s	
Cushion	None	
Stroke length tolerance	+1.0 0	
Rod end type	With thread/Without thread	
Mounting	Panel mount type	Embedded type
Accessory (Standard equipment)	Standard equipment	Mounting nut (2) Rod end nut (2)*1
	Option	Hose nipple (Excludes ø4)
		Mounting nut (1) Gasket (1) Rod end nut (2)*1

*1 When rod end is threaded

* For details about the hose nipple (accessory), refer to page 8.

Weight

Bore size [mm]	Stroke [mm]		
	5	10	15
4	10	13	15
6	10.6	13.1	15.6
10	28	33	38
16	72	82	92

* Weight of hose nipple (4 g) for panel mounting is excluded.

Hose Nipple Dedicated for Panel Mount Type (With fixed orifice)

Applicable tubing	Part no.
For $\phi 4/\phi 2.5$ tubing	CJ-5H-4
For $\phi 6/\phi 4$ tubing	CJ-5H-6

Theoretical Output

Bore size [mm]	Operating direction	Operating pressure [MPa]		
		0.3	0.5	0.7
4	OUT	0.97	3.48	6.00
	IN	1.0		
6	OUT	4.56	10.2	15.9
	IN	1.42		
10	OUT	17.6	33.3	49.0
	IN	2.45		
16	OUT	44.5	84.7	124.9
	IN	5.04		

Spring Reaction Force

Bore size [mm]	Stroke [mm]	[N]	
		Retracted side	Extended side
4	5, 10, 15	2.80	1.00
6	5, 10, 15	3.92	1.42
10	5, 10, 15	5.98	2.45
16	5, 10, 15	15.78	5.04

* Same spring force for each stroke

Allowable Kinetic Energy

⚠ Caution

When driving an inertial load, operate a cylinder with kinetic energy within the allowable value. The range in the chart below that is delineated by bold solid lines indicates the relation between load mass and maximum driving speeds.

Bore size [mm]	4	6	10	16
Piston speed [m/s]	0.05 to 0.5			
Allowable kinetic energy [J]	0.5×10^{-3}	3×10^{-3}	8×10^{-3}	19×10^{-3}

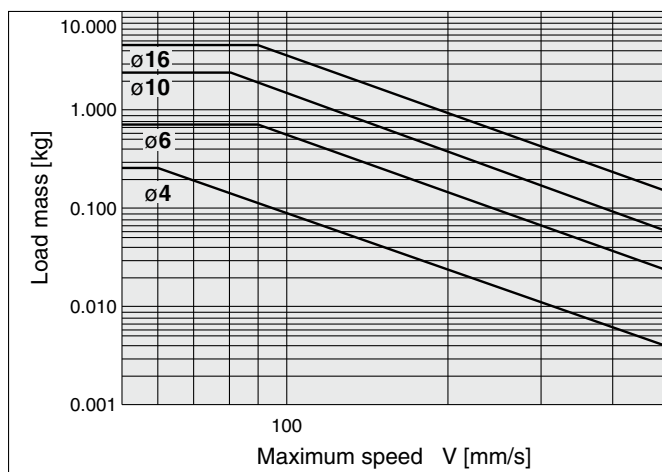

Allowable Lateral Load

Strictly observe the limiting range of lateral load on a piston rod. (Refer to the below graph.) If this product is used beyond the limits, it may shorten the machine's life or cause damage.

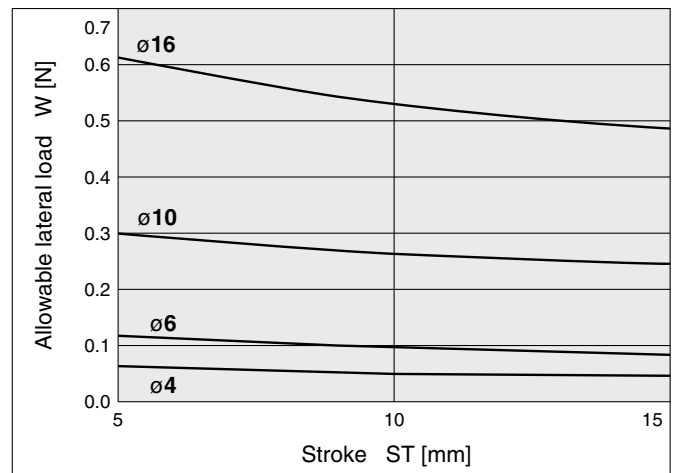

CJP Series

Construction (Not able to disassemble.)

Panel Mount Type

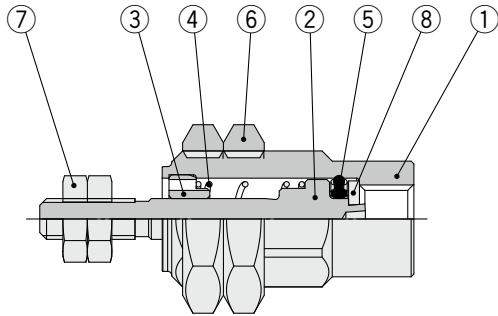

Embedded Type

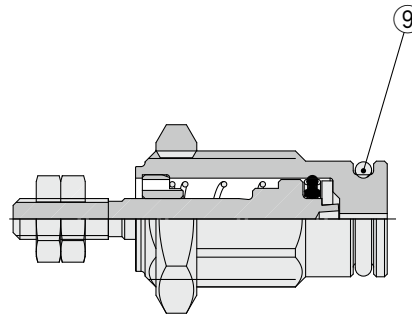

Component Parts

No.	Description	Material	Note		
1	Tube	Brass	Electroless nickel plating		
2	Piston	Stainless steel			
3	Collar	ø4, ø6, ø10	Brass	ø4, ø6, ø10	Electroless nickel plating
		ø16	Oil-impregnated sintered alloy	ø16	—
4	Return spring	Steel wire	Zinc chromating		
5	Piston seal	NBR			
6	Mounting nut	ø4	Brass	Electroless nickel plating	
		ø6, ø10, ø16	Steel	Zinc chromating	
7	Rod end nut	Steel	Zinc chromating		
8	Seal retainer	Stainless steel	Only applicable to ø6, ø10, and ø16		
9	Gasket	NBR	Embedded type only		

Replacement Parts: Gasket

Bore size [mm]	Order no.	Contents
4	CJPS4-G	Above no. ⑨
6	CJPS6-G	
10	CJPS10-G	
16	CJPS16-G	

* For the embedded type
 * Since gaskets (10 pcs./set) do not include a grease pack (10 g), order it separately.

Grease pack part number:
GR-S-010 (10 g)

Dimensions

Panel Mount Type

CJPB4

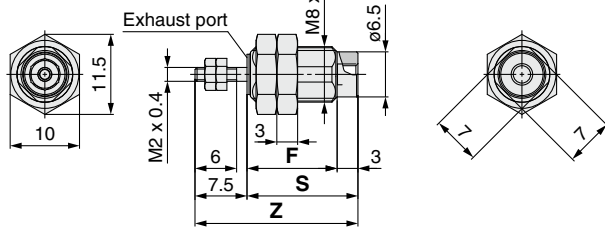

Without rod end thread
CJPB4-□-B

CJPB6/10/16

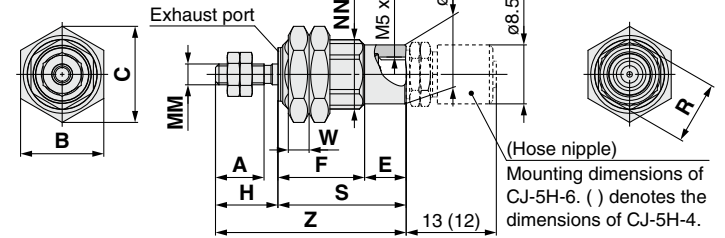

Without rod end thread
CJPB□-□-B

Bore size	A	B	C	E	F			G	H	MM	NN	R	S			W	Z			Q
					5 st	10 st	15 st						5 st	10 st	15 st		5 st	10 st	15 st	
4	6	10	11.5	3	13	21	29	6.5	7.5	M2 x 0.4	M8 x 1.0	7	16	24	32	3	23.5	31.5	39.5	2
6	7	12	13.9	6	12.5	19.5	26.5	8.5	9	M3 x 0.5	M10 x 1.0	9	18.5	25.5	32.5	3	27.5	34.5	41.5	3
10	10	19	22	6	14.5	21	28	12	12	M4 x 0.7	M15 x 1.5	13	20.5	27	34	4	32.5	39	46	5
16	12	27	31	7	16.5	22.5	29	19	14	M5 x 0.8	M22 x 1.5	20	23.5	29.5	36	5	37.5	43.5	50	6

Embedded Type

CJPS4

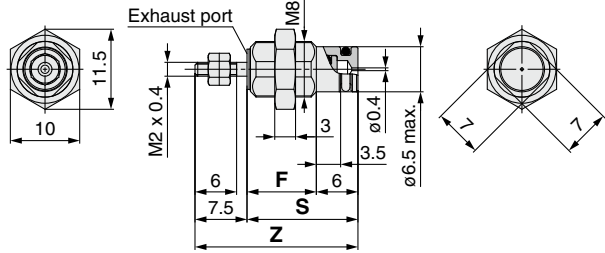

Without rod end thread
CJPS4-□-B

CJPS6/10/16

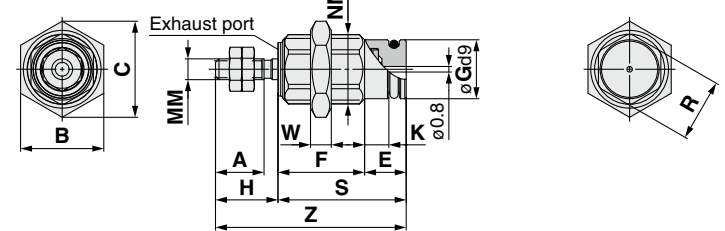

Without rod end thread
CJPS□-□-B

Bore size	A	B	C	E	F			G	H	K	MM	NN	R	S			W	Z			Q
					5 st	10 st	15 st							5 st	10 st	15 st		5 st	10 st	15 st	
4	6	10	11.5	6	10	18	26	6.5	7.5	—	M2 x 0.4	M8 x 1.0	7	16	24	32	3	23.5	31.5	39.5	2
6	7	12	13.9	6	12.5	19.5	26.5	8.5	9	3.5	M3 x 0.5	M10 x 1.0	9	18.5	25.5	32.5	3	27.5	34.5	41.5	3
10	10	19	22	6	14.5	21	28	12	12	3.5	M4 x 0.7	M15 x 1.5	13	20.5	27	34	4	32.5	39	46	5
16	12	27	31	7	16.5	22.5	29	19	14	4.2	M5 x 0.8	M22 x 1.5	20	23.5	29.5	36	5	37.5	43.5	50	6

Recommended Mounting Hole Dimensions for Embedded Type

Machining dimensions for mounting

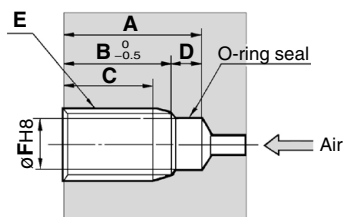

Bore size	Stroke	A	B	C	D	E	F
4	5	12	8.5	6	3.5	M8 x 1.0	6.5
	10	20	16.5	14			
	15	28	24.5	22			
6	5	16	12.5	10	3.5	M10 x 1.0	8.5
	10	23	19.5	17			
	15	30	26.5	24			
10	5	17	13.5	10.5	3.5	M15 x 1.5	12
	10	23.5	20	17			
	15	30.5	27	24			
16	5	19	14.5	11.5	4.5	M22 x 1.5	19
	10	25	20.5	17.5			
	15	31.5	27	24			

* E and ϕF should be machined in a concentric manner.

Accessory Bracket Dimensions

Rod End Cap

Flat Type: CJ-CF□

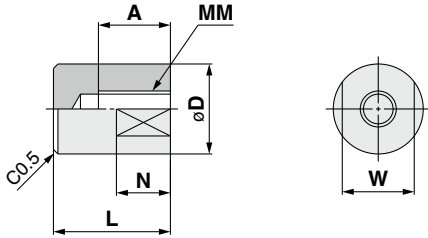

Round Type: CJ-CR□

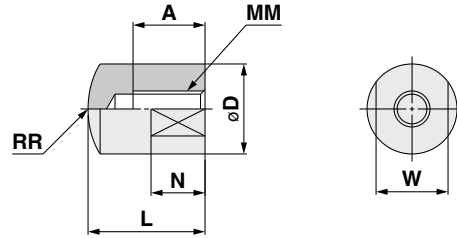

Material: Polyacetal [mm]

Part no.		Applicable bore size [mm]	A	D	L	MM	N	RR	W
Flat type	Round type								
CJ-CF004	CJ-CR004	4	5	6	9	M2 x 0.4	3	6	5
CJ-CF006	CJ-CR006	6	6	8	11	M3 x 0.5	5	8	6
CJ-CF010	CJ-CR010	10	8	10	13	M4 x 0.7	6	10	8
CJ-CF016	CJ-CR016	16	10	12	15	M5 x 0.8	7	12	10

* Rod end nut is not included when rod end cap is ordered individually. (Please use the rod end nut of the standard cylinder.)

* Applicable only for the rod end with the thread type

Accessory

Mounting Nut (Standard equipment): SNPS-□□

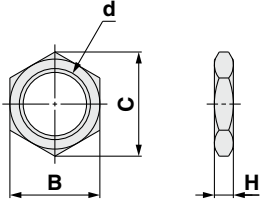

Material: ø4 Brass ø6, ø10, ø16 Steel [mm]

Part no.	Applicable bore size [mm]	d	H	B	C	Maximum tightening torque [N·m]
SNPS-004	4	M8 x 1.0	3	10	11.5	1.2
SNPS-006C	6	M10 x 1.0	3	12	13.9	4.2
SNPS-010C	10	M15 x 1.5	4	19	22	16.7
SNPS-016C	16	M22 x 1.5	5	27	31	30.6

Rod End Nut (Standard equipment): NTJ-004, NTP-□

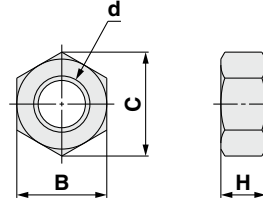

Material: Steel [mm]

Part no.	Applicable bore size [mm]	d	H	B	C	Maximum tightening torque [N·m]
NTJ-004	4	M2 x 0.4	1.6	4	4.6	0.1
NTP-006	6	M3 x 0.5	1.8	5.5	6.4	0.3
NTP-010	10	M4 x 0.7	2.4	7	8.1	0.8
NTP-016	16	M5 x 0.8	3.2	8	9.2	1.6

* With rod end thread

Related Products

Refer to the [Web Catalog](#).

ø2 Miniature Fittings
M Series

ø2 One-touch Fittings

ø2 Speed Controller
AS Series

ø2 Polyurethane Tubing
TU Series

CJP Series Simple Specials

The following changes are dealt with through the Simple Specials System.

To place an order, please download the Simple Special Order Specification Form from the SMC website.



1 CJP (ø6 to ø16): Change of Rod End Shape

Symbol

-XA0/1/10/11

Applicable Series

Series		Action	Symbol for change of rod end shape
CJP	Standard type Single acting, Spring return	CJP Single acting (Spring return)	ø6 to ø16 XA0, XA1, XA10, XA11

Precautions

- SMC will make appropriate arrangements if no dimension, tolerance, or finish instructions are given in the diagram.
- Standard dimensions marked with "*" will be as follows to the rod diameter (D). Enter any special dimension you require.
ø6 to ø16 → D - 1 mm
- Please contact SMC separately for the piston rod end pattern part numbers other than the table above.
- "A0" is the same shape as the standard type.
(The specifications of A0 are that only dimensions A and H are changed from the standard type.)

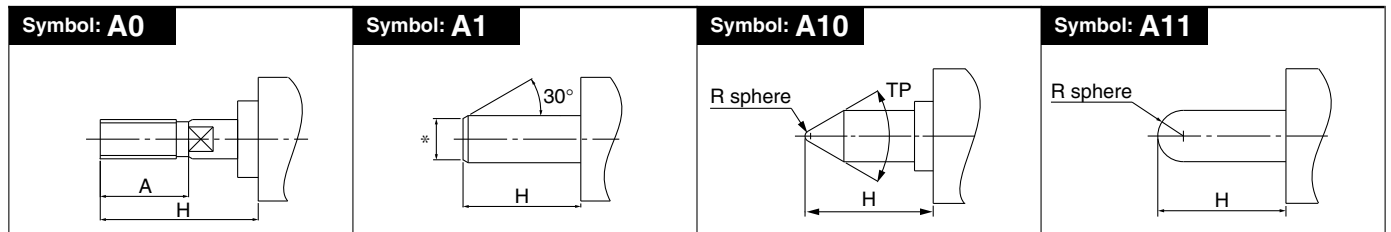

1 Pin Cylinder with Rod Quenched

Symbol
-XC17

The piston rod material is changed and the rod end is quenched.

Applicable Series

Series	Description	Model	Action	Note
CJP	Pin cylinder	CJPB	Single acting (Panel mount)	Excludes ø4
		CJPS	Single acting (Embedded)	Excludes ø4

How to Order

Standard model no. **-XC17**

* Only the rod end without thread is available.
The symbol B for the rod end type is not used any more.

Pin cylinder with rod quenched

Specifications: Same as the standard type

Construction (Dimensions are the same as the standard type.)

- * The shape and the dimension of quenched part of the rod end are the same for both panel mount type and embedded type.
- * The figure below shows the panel mount type.

CJPB

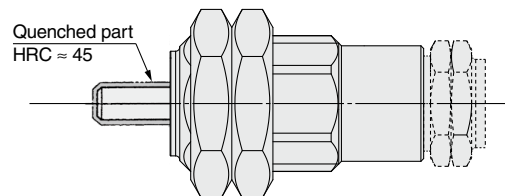

2 Fluororubber Seals

Symbol
-XC22

Applicable Series

Series	Description	Model	Action	Note
CJP	Pin cylinder	CJPB	Single acting (Panel mount)	Excludes ø4
		CJPS	Single acting (Embedded)	Excludes ø4

How to Order

Standard model no. **-XC22**

Fluororubber seals

Specifications

Seal material	Fluororubber
Specifications other than the above and dimensions	Same as the standard type

- * Please confirm with SMC, as the type of chemical and the operating temperature may not allow the use of this product.



CJP Series

Specific Product Precautions

Be sure to read this before handling the products. Please consult with SMC for the use other than the specifications.

Piping

⚠ Caution

The following fittings are recommended for this cylinder connection. However, there may be a case where the piston speed exceeds 500 mm/s even with the recommended fittings for this cylinder. Use a speed controller in such cases.

Cylinder bore size	Applicable tubing O.D.	Fitting type	Connection thread	Model
ø4	ø2	One-touch fitting	M3 x 0.5	KQ2□02-M3G
		Miniature fitting		M-3AU-2
One-touch fitting		M5 x 0.8	KQ2□02-M5N	
Miniature fitting			M-5AU-2	
ø6 ø10 ø16	ø4/2.5	Dedicated hose nipple (with fixed orifice)	M5 x 0.8	CJ-5H-4
	ø6/4			CJ-5H-6

* Please be aware that cylinder speed may slow down on the retracting side when using the above One-touch fittings and miniature fittings with a cylinder bore size of ø16.

Hose nipple

CJ-5H-4
(For ø4/ø2.5 tubing)

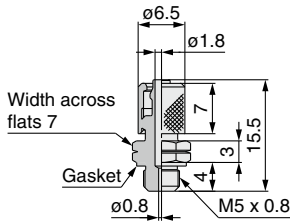

CJ-5H-6
(For ø6/ø4 tubing)

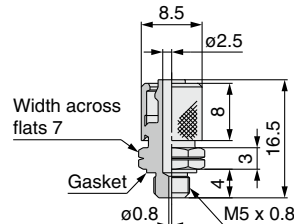

In addition to the above fittings and hose nipples, the below fittings can also be attached to the cylinder. When using the below fittings, be sure to provide a speed controller after adjusting it to 500 mm/s or less.

Cylinder bore size	Applicable tubing O.D.	Fitting type	Connection thread	Model
ø4	3.2	One-touch fitting	M3 x 0.5	KQ2□23-M3G
	4			KQ2□04-M3G
ø6	3.2		M5 x 0.8	KQ2□23-M5□
	4			KQ2□04-M5□
ø10	6		KQ2□06-M5□	
ø16				

Recommended Speed Controller

Applicable tubing O.D. [mm]	Connection thread	Elbow type meter-in	Universal type meter-in	In-line type meter-in
ø2	M3	AS1211F-M3-02	—	AS1002F-02
	M5	AS1211F-M5E-02A	—	
ø3.2	M3	AS1211F-M3-23	AS1311F-M3-23	AS1002F-23
	M5	AS1211F-M5E-23A	AS1311F-M5E-23A	
ø4	M3	AS1211F-M3-04	AS1311F-M3-04	AS1002F-04
	M5	AS1211F-M5E-04A	AS1311F-M5E-04A	
ø6	M5	AS1211F-M5E-06A	AS1311F-M5E-06A	AS1002F-06

* For details about One-touch fittings, miniature fittings and speed controllers (applicable tubing O.D. ø2 only), refer to the **Web Catalog**. Also, for details about speed controllers (applicable tubing O.D. ø3.2 to ø6), refer to the **Web Catalog**.

* Refer to the Fittings and Tubing Precautions (**Web Catalog**) for handling One-touch fittings.

Mounting

⚠ Caution

Do not use it in such a way that a load could be applied to the piston rod during the retraction. The spring that is built into the cylinder provides only enough force to retract the piston rod. Thus, if a load is applied, the piston rod may not be able to retract to the end of the stroke.

Safety Instructions

These safety instructions are intended to prevent hazardous situations and/or equipment damage. These instructions indicate the level of potential hazard with the labels of “**Caution**,” “**Warning**” or “**Danger**.” They are all important notes for safety and must be followed in addition to International Standards (ISO/IEC)*1), and other safety regulations.

 **Caution:** **Caution** indicates a hazard with a low level of risk which, if not avoided, could result in minor or moderate injury.

 **Warning:** **Warning** indicates a hazard with a medium level of risk which, if not avoided, could result in death or serious injury.

 **Danger:** **Danger** indicates a hazard with a high level of risk which, if not avoided, will result in death or serious injury.

*1) ISO 4414: Pneumatic fluid power – General rules relating to systems.
ISO 4413: Hydraulic fluid power – General rules relating to systems.
IEC 60204-1: Safety of machinery – Electrical equipment of machines.
(Part 1: General requirements)
ISO 10218-1: Manipulating industrial robots – Safety.
etc.

Warning

1. The compatibility of the product is the responsibility of the person who designs the equipment or decides its specifications.

Since the product specified here is used under various operating conditions, its compatibility with specific equipment must be decided by the person who designs the equipment or decides its specifications based on necessary analysis and test results. The expected performance and safety assurance of the equipment will be the responsibility of the person who has determined its compatibility with the product. This person should also continuously review all specifications of the product referring to its latest catalog information, with a view to giving due consideration to any possibility of equipment failure when configuring the equipment.

2. Only personnel with appropriate training should operate machinery and equipment.

The product specified here may become unsafe if handled incorrectly. The assembly, operation and maintenance of machines or equipment including our products must be performed by an operator who is appropriately trained and experienced.

3. Do not service or attempt to remove product and machinery/equipment until safety is confirmed.

1. The inspection and maintenance of machinery/equipment should only be performed after measures to prevent falling or runaway of the driven objects have been confirmed.
2. When the product is to be removed, confirm that the safety measures as mentioned above are implemented and the power from any appropriate source is cut, and read and understand the specific product precautions of all relevant products carefully.
3. Before machinery/equipment is restarted, take measures to prevent unexpected operation and malfunction.

4. Contact SMC beforehand and take special consideration of safety measures if the product is to be used in any of the following conditions.

1. Conditions and environments outside of the given specifications, or use outdoors or in a place exposed to direct sunlight.
2. Installation on equipment in conjunction with atomic energy, railways, air navigation, space, shipping, vehicles, military, medical treatment, combustion and recreation, or equipment in contact with food and beverages, emergency stop circuits, clutch and brake circuits in press applications, safety equipment or other applications unsuitable for the standard specifications described in the product catalog.
3. An application which could have negative effects on people, property, or animals requiring special safety analysis.
4. Use in an interlock circuit, which requires the provision of double interlock for possible failure by using a mechanical protective function, and periodical checks to confirm proper operation.

Caution

1. The product is provided for use in manufacturing industries.

The product herein described is basically provided for peaceful use in manufacturing industries.
If considering using the product in other industries, consult SMC beforehand and exchange specifications or a contract if necessary.
If anything is unclear, contact your nearest sales branch.

Limited warranty and Disclaimer/ Compliance Requirements

The product used is subject to the following “Limited warranty and Disclaimer” and “Compliance Requirements”.

Read and accept them before using the product.

Limited warranty and Disclaimer

1. The warranty period of the product is 1 year in service or 1.5 years after the product is delivered, whichever is first.*2)
Also, the product may have specified durability, running distance or replacement parts. Please consult your nearest sales branch.
2. For any failure or damage reported within the warranty period which is clearly our responsibility, a replacement product or necessary parts will be provided.
This limited warranty applies only to our product independently, and not to any other damage incurred due to the failure of the product.
3. Prior to using SMC products, please read and understand the warranty terms and disclaimers noted in the specified catalog for the particular products.

*2) Vacuum pads are excluded from this 1 year warranty.

A vacuum pad is a consumable part, so it is warranted for a year after it is delivered.
Also, even within the warranty period, the wear of a product due to the use of the vacuum pad or failure due to the deterioration of rubber material are not covered by the limited warranty.

Compliance Requirements

1. The use of SMC products with production equipment for the manufacture of weapons of mass destruction (WMD) or any other weapon is strictly prohibited.
2. The exports of SMC products or technology from one country to another are governed by the relevant security laws and regulations of the countries involved in the transaction. Prior to the shipment of a SMC product to another country, assure that all local rules governing that export are known and followed.

Caution

SMC products are not intended for use as instruments for legal metrology.

Measurement instruments that SMC manufactures or sells have not been qualified by type approval tests relevant to the metrology (measurement) laws of each country. Therefore, SMC products cannot be used for business or certification ordained by the metrology (measurement) laws of each country.

Safety Instructions

Be sure to read the “Handling Precautions for SMC Products” (M-E03-3) and “Operation Manual” before use.