

Stroke Reading Cylinder and Counter

CE Series



CEP1
CE1
CE2
ML2B

CEP1/CEU5

Resolution: 0.01 mm (Accuracy ± 0.02 mm)

Output function: RS-232C BCD

Output: 5 points (Bank switching: 20 points)
31 points (Binary output)

230.45



High Precision Stroke Reading Cylinder CEP1 Series

$\phi 12, \phi 20$



P.647

Stroke Reading Cylinder CE1 Series

$\phi 12, \phi 20, \phi 32, \phi 40, \phi 50, \phi 63$



P.656

Multi-counter CEU5 Series



P.667

D-
-X

Air Cylinder with Measurement Function/Stroke Reading Cylinder *CE Series*

Counter *CEU Series*

Measurement is possible throughout the full stroke range.

The home position can be anywhere → When the counter is reset by pressing the cylinder rod to the reference plane, that point becomes the home position.

Can be used in an environment where the product is exposed to fluids (water, oil, coolant, etc.)

CEP1 Series With special scraper as standard

High Precision Stroke Reading Cylinder (CEP1)

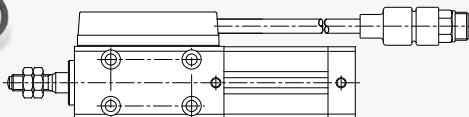

- Resolution: 0.01 mm (Accuracy ± 0.02 mm)
- Special scraper now standard (IP-67)
- 2 types of seal material available (Made to Order)
- Power supply voltage 12 to 24 VDC

- Auto switch mounting orientation can be freely selected (3 mounting surfaces)

Stroke Reading Cylinder (CE1)



- Resolution: 0.1 mm (Accuracy ± 0.2 mm)

- Power supply voltage 12 to 24 VDC
- Abundant stroke variations
- Improved noise resistance

System Configuration

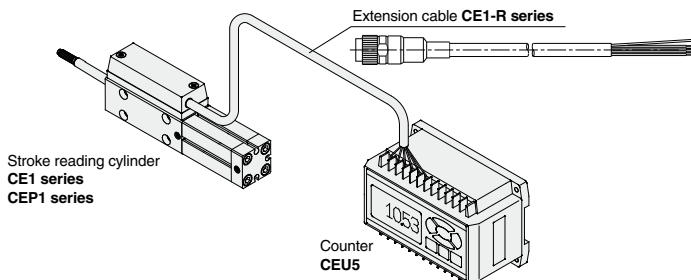

Achieve rationalization of production lines

Stroke reading cylinder with position feedback

Tolerances of preset values can be set.

Tolerances can be set for preset values.
+ set tolerance, - set tolerance (separate settings)

Simple operation

Multi-counter (CEU5)

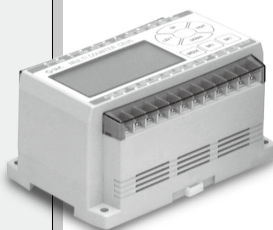
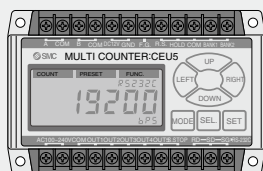

- Output terminal: 5 points
- Number of output settings:
20 points (Bank switching)
31 points (Binary output)
- Communication function with RS-232C
- With BCD output (Option)
- Maximum counting speed 100 kHz
- Prescale function
- With multiplication switching
(1, 2, 4 multiplication)
- DIN rail mountable
- 6 digits count display

Series Variations

CE1 Series

Bore size (mm)	Standard stroke (mm)										Manufacturable stroke range		
	25	50	75	100	125	150	175	200	250	300		400	500
12	●	●	●	●	●	●							25 to 150
20	●	●	●	●	●	●	●	●					25 to 300
32		●	●	●	●	●	●	●	●	●			25 to 400
40				●	●	●	●	●	●	●	●		25 to 600
50								●	●	●	●		25 to 600
63								●		●		●	25 to 600

CEU5

Power supply voltage	Count data output		RS-232C+BCD		RS-232C	
	Output transistor mode		NPN	PNP	NPN	PNP
100 to 240 VAC	●	●	●	●	●	●
24 VDC	●	●	●	●	●	●

Extension Cable

Cable length (m)			
5	10	15	20
●	●	●	●

CEP1 Series

Bore size (mm)	Standard stroke (mm)				Manufacturable stroke range
	25	50	75	100	
12 equivalent	●	●	●	●	1 to 150
20 equivalent	●	●	●	●	1 to 300

* Strokes other than standard strokes are available upon request. Consult with SMC separately.

CEP1

CE1

CE2

ML2B

Application Examples

Parts inspection

Measures the dimensions of parts, discriminates between good and defective articles, and prevents the mingling of different parts, etc.

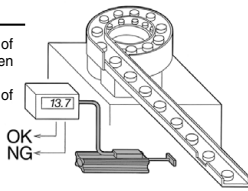

Confirmation of press-in

Can confirm the press-in of a hydraulic cylinder by detecting its stroke. Even if the size of the workpiece changes, the point of press-in completion can be easily changed.

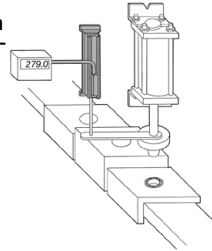

Detection of die assembly's deceleration point

Since the deceleration point of the die assembly can be set at will, it can be easily changed after replacement of the die assembly.

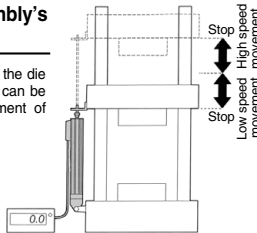

Discrimination of direction

Maintains a constant height of measuring workpiece height.

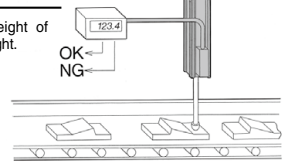

Length/breadth discrimination

Distinguishes either lengthwise or crosswise while correcting the position of a workpiece.

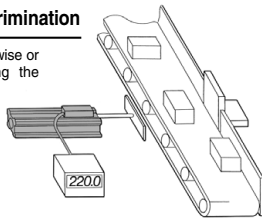

Detection of lifter position

Can continuously monitor a lifter's stroke.

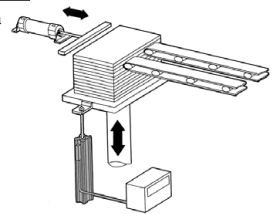

Inspection of machined holes

Can detect machined hole depth, burrs and foreign matter, etc.

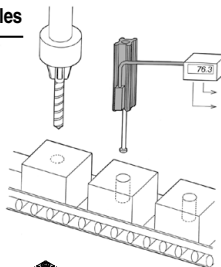

Nozzle height adjustment

Maintains a certain height of a workpiece and a nozzle by measuring the height of a workpiece.

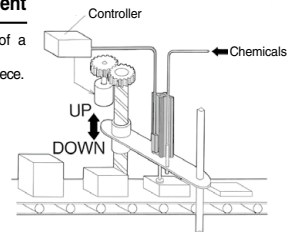

Measurement of dimensions

Can measure dimensions of parts.

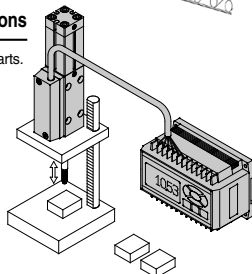

Measurement of machining dimensions

Performs adjustment of machining depth, etc. by measuring the part dimensions before machining.

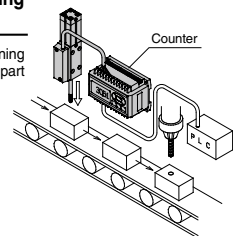

Measurement Principle

The amount of rod movement in the stroke reading cylinder is detected using an MR element (magnetic resistance element) whose resistance value changes due to magnetic force. The detection unit containing this MR element is called the sensor head. An amplifying circuit and a dividing circuit are required to produce output which can be read by the counter, and these are attached to the cylinder case. The sensor head and amplifier section together are referred to as the sensor unit.

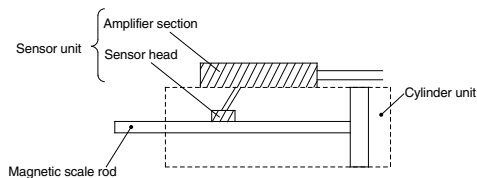

The stroke reading cylinder is equipped with the capability of outputting the piston stroke movement as a pulse signal. The measurement principle is as shown in the drawing below.

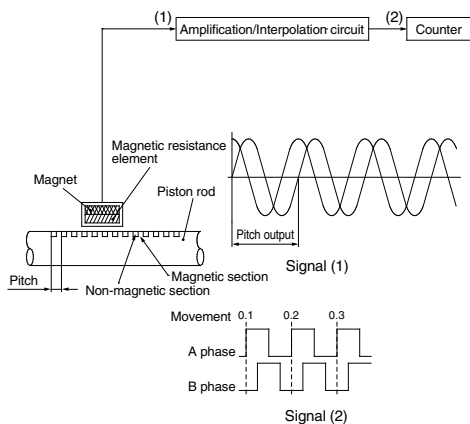

1. Scales of magnetic layers and non-magnetic layers are etched at a certain pitch on the piston rod.
2. With movement of the piston rod, a sin, cos 2-phase signal (Signal (1)) is received by the magnetic resistance element. For this wave form, 1 pitch (0.8 mm) becomes exactly 1 cycle.
3. This is amplified and divided into 1/8 parts. As a result, a 90° phase difference pulse signal of 0.1 mm/pulse (Signal (2)) is output.
4. By measuring this pulse signal with the counter, it is possible to detect the piston position with a resolution of 0.1 mm.
5. In the case of the high precision stroke reading cylinder, the sin, cos 2-phase signal obtained in 2 is amplified and divided into 1/20 parts. As a result, a 90° phase difference pulse signal of 0.04 mm/pulse (Signal (2)) is output.
6. By multiplying this pulse signal by 4 with the counter, it is possible to detect the piston position with a resolution of 0.01 mm.

A/B Phase Difference Output (90° phase difference output)

When movement is expressed by a single line of pulses, it is impossible to accurately identify the current position, because pulse waves appear in both upward and downward directions.

Accordingly, in A/B phase difference output, two lines of pulses are provided, wherein one line detects the movement and the other distinguishes the direction.

The CE1 also employs this system.

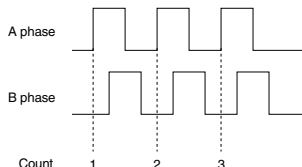

4 Times Multiplication Function

This function increases resolution 4 times by counting 4 for each cycle of pulses, instead of counting 1 for each cycle as is normally the case. In principle, this function counts each time there is a rise or fall in either of the A or B phase pulses.

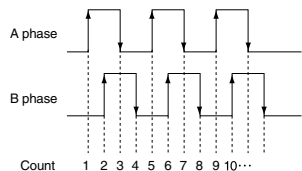

Counting Speed (kHz, kcps)

Counting speed indicates the number of pulses that can be counted per second. If the stroke reading cylinder is operated at high speeds, pulse waves are output in shorter cycles. The counting speed of the counter must be higher than the pulse speed for the maximum piston speed when operating. Since the stroke reading cylinder outputs one pulse for each 0.1 mm of movement, 5,000 pulses will be output for each 500 mm of movement. Therefore, a speed of 500 mm/s is equivalent to 5 kcps (kHz), but a counting speed 2 to 3 times greater is recommended for actual operation.

Accuracy

The accuracy is the difference between the dimensions based upon the signals of the stroke reading cylinder and the absolute dimensions.

The maximum display error that will appear on the counter's digital display is equal to twice (± 1 count) the resolution when the home position is reset and when dimensions are measured.

CEP1

CE1

CE2

ML2B

D-□

-X□



CE Series

Specific Product Precautions

Be sure to read this before handling the products.

Refer to back page 50 for Safety Instructions and pages 3 to 12 for Actuator and Auto Switch Precautions.

⚠ Caution

Operating Environment

Use in an environment where liquid (water, oil, coolant, etc.) splashes on the product may result in a malfunction; therefore, if using in such an environment, be sure to take measures such as installing a waterproof, dust-proof cover, etc. (CE1)

Mounting

- When screwing a nut or fitting, etc. onto the threaded section at the end of the piston rod, return the piston rod to its fully retracted position, and grasp the exposed portion of the rod across two parallel sides with a wrench. In the case of the high precision stroke reading cylinder, there are no parallel sides. Secure the workpiece with a double nut.

Note) Do not apply rotational torque to the piston rod.

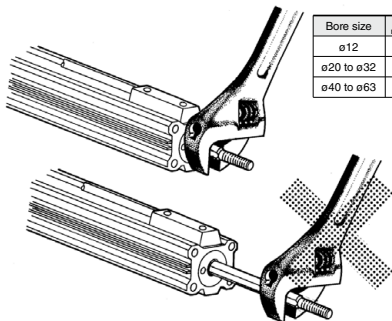

Bore size	Allowable rotational torque
ø12	10 N·m
ø20 to ø32	20 N·m
ø40 to ø63	30 N·m

- Operate the cylinder in such a way that the load is always applied in the axial direction.
 - In case the load is applied in a direction other than the axial direction of the cylinder, provide a guide to constrain the load itself.
 - When mounting a cylinder, centering should be done carefully.
- Avoid using the air cylinder in such a way that rotational torque would be applied to the piston rod.

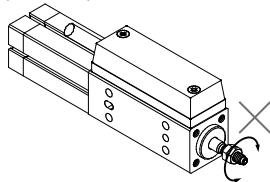

- Be careful to avoid scratches or dents, etc. on the sliding sections of the piston rod.

Sensor Unit

- The sensor unit is adjusted to an appropriate position at the time of shipment. Therefore, never detach the sensor unit from the body.
- The sensor cable should not be pulled with a strong force.
- Since the sensor for stroke reading cylinder adopts the magnetic method, it may result in malfunction if there is a strong magnetic field around the sensor. Use it under the external magnetic field with 14.5 mT or less.

This is equivalent to a magnetic field of approximately 18 cm in radius from a welding area using a welding amperage of almost 15,000 amperes. To use the system in a magnetic field that exceeds this value, use a magnetic material to shield the sensor unit.

- Switches or relays, etc. should not be installed in the power supply line (12 to 24 VDC).

⚠ Caution

Effects of Noise

When the stroke reading cylinder is used near a motor, welding machine or other source of noise generation, there is a possibility of miscounting. In this case, noise should be suppressed as much as possible and the following countermeasure should be taken.

- Connect the shield wire to FG (frame ground).
- The maximum transmission distance for the stroke reading cylinder is 23 m, but since the output signal is a pulse output, the sensor cable should be wired separately from other power lines.

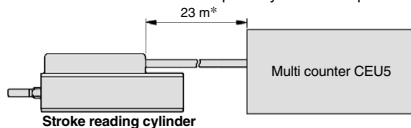

* When using SMC extension cable and counter.

Noise Counter Measures

Methods of dealing with noise are given below.

- Connect only the shield wire to FG (frame ground).
- Use a power source separate from large motors and AC valves, etc.
- Run the stroke reading cylinder's cable away from other power lines.
- Install a noise filter in the 100 VAC power line, a varistor in the DC power supply of the sensor cable and a ferritic core in the signal line (sensor cable).

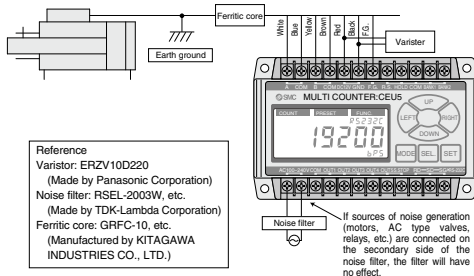

Reference
 Varistor: ERZV10D220
 (Made by Panasonic Corporation)
 Noise filter: RSEL-2003W, etc.
 (Made by TDK-Lambda Corporation)
 Ferritic core: GRFC-10, etc.
 (Manufactured by KITAGAWA INDUSTRIES CO., LTD.)

SMC MULTI COUNTER-CEU5
 If sources of noise generation (motors, AC type valves, relays, etc.) are connected on the secondary side of the noise filter, the filter will have no effect.

<Counting speed of counter>

When the speed of the stroke reading cylinder is greater than the counting speed of the counter, the counter will miscount. For CE1 (when measuring to 0.1 mm), a counter should be used with a counting speed of 10 kHz (kcps) or more. And for CEP1 (when measuring to 0.01 mm), use a counter with a counting speed of 50 kHz (kcps) or more when 4 times multiplication is input.

<Malfunction due to lurching and bounding>

When lurching or bounding occurs at the beginning or end of stroke reading cylinder, or due to other causes, the cylinder speed momentarily increases, and there is a possibility of exceeding the counting speed of the counter or the response speed of the sensor, thereby causing a miscount.

Handling of Technical Material

The operation manuals should be read before using the CEP1 series high precision stroke reading cylinder, CEU5 multi counter, CE1 scale cylinder and CEU1 3 point preset counter.

High Precision Stroke Reading Cylinder Non-rotating Piston Type

CEP1 Series

ø12, ø20



Note) CE-compliant: When connecting to a multi-counter (CEU5□□-D, power supply voltage 24 VDC). Refer to the multi-counter operation manual for details.

How to Order

CEP1 **B** **12** - **50** - **M9BW** -

High precision stroke reading cylinder

Mounting type

B	Direct mounting rod side tapped type
L	Foot type
F	Rod side flange type

Bore size

12	ø12 mm equivalent
20	ø20 mm equivalent

Standard cylinder stroke (mm)

Refer to "Standard Stroke" on page 648.

Connector

Nil	With connector
Z	Without connector

Sensor cable length

Nil	0.5 m
L	3 m

Number of auto switches

Nil	2 pcs.
S	1 pc.
n	"n" pcs.

Auto switch

Nil	Without auto switch (Built-in magnet)
------------	---------------------------------------

* For the applicable auto switch model, refer to the table below.

<Made to Order>

Fluororubber seals: -XC22
(Example) CEP1B12-100-M9N-XC22

<Option>

Extension cable **CE1-R** **05**

Cable length

05	5 m
10	10 m
15	15 m
20	20 m

Suffix

Nil	Extension cable
C	Extension cable & connector

Applicable counter
CEU5 series

Mounting Bracket Part No.

Cylinder part no.	Foot	Rod side flange
CEP1□12	CEP1-L12	CEP1-F12
CEP1□20	CEP1-L20	CEP1-F20

Applicable Auto Switches

Refer to pages 941 to 1067 for further information on auto switches.

Type	Special function	Electrical entry	Indicator sign	Wiring (Output)	Load voltage		Auto switch model		Lead wire length (m)					Pre-wired connector	Applicable load
					DC	AC	Perpendicular	In-line	0.5 (Nil)	1 (M)	3 (L)	5 (Z)			
													5 V, 12 V		
Solid state auto switch	—	Grommet	Yes	3-wire (NPN)	24 V	5 V, 12 V	—	M9PV	M9P	●	●	○	○	IC circuit	Relay, PLC
				3-wire (PNP)				M9BV	M9B	●	●	○	○		
				2-wire				M9NWV	M9NW	●	●	○	○		
				2-wire				M9PWV	M9PW	●	●	○	○		
	Diagnostic indication (2-color indicator)			3-wire (NPN)	M9BWV	M9BV	●	●	○	○	—				
					3-wire (PNP)	M9NAV ^{*1}	M9NA ^{*1}	○	○	○		○	IC circuit		
						2-wire	M9PAV ^{*1}	M9PA ^{*1}	○	○		○		○	
					Water resistant (2-color indicator)		3-wire (PNP)	M9BAV ^{*1}	M9BA ^{*1}	○		○	○	○	
2-wire	A96V	A96	●	—		●		—	IC circuit						
	Read auto switch	—	Grommet	Yes	24 V	12 V	100 V	A93V ^{*2}		A93	●	●	●	●	—
100 V or less								A90V	A90	●	—	●	—	IC circuit	

*1 Water resistant type auto switches can be mounted on the above models, but in such case SMC cannot guarantee water resistance.

Consult with SMC regarding water resistant types with the above model numbers.

*2 1 m type lead wire is only applicable to D-A93.

* Lead wire length symbols: 0.5 m Nil (Example) M9NV
1 m M (Example) M9NWM
3 m L (Example) M9NWL
5 m Z (Example) M9NWLZ

* Solid state auto switches marked with "○" are produced upon receipt of order.

* Refer to page 655 for details on other applicable auto switches than listed above.

* For details about auto switches with pre-wired connector, refer to pages 1014 and 1015.

* Auto switches are shipped together (not assembled).



CEP1

CE1

CE2

ML2B

D-□

X-□

CEP1 Series



Symbol



Made to Order Specifications
[Click here for details](#)

Symbol	Specifications
-XC22	Fluororubber seals

Cylinder Specifications

Action	Double acting, Single rod (Non-rotating piston)	
Fluid	Air	
Proof pressure	1.5 MPa	
Maximum operating pressure	1.0 MPa	
Minimum operating pressure	ø12	ø20
	0.15 MPa	0.1 MPa
Piston speed	50 to 300 mm/s	
Ambient and fluid temperature	0 to 60°C (No freezing)	
Lubrication	Non-lube	
Stroke length tolerance range	0 to +1.0 mm	
Cushion	Without	
Rod non-rotating accuracy	ø12	ø20
	±2°	±3°
Mounting	Direct mounting rod side tapped type (Standard), Foot type, Rod side flange type	

Sensor Specifications

Cable	ø7, 6 core twisted pair shielded wire (Oil, Heat & Flame resistant)
Maximum transmission distance	23 m (when using SMC cable and counter)
Position detection method	Magnetic scale rod, sensor head <Incremental type>
Magnetic field resistance	14.5 mT
Power supply	10.8 to 26.4 VDC (Power supply ripple: 1% or less)
Current consumption	50 mA
Resolution	0.01 mm (With 4 times multiplication)
Accuracy	±0.02 mm ⁽¹⁾ (at 20°C)
Output type	Open collector (24 VDC, 40 mA)
Output signal	A/B phase difference output
Insulation resistance	500 VDC, 50 MΩ or more (between case and 12E)
Vibration resistance	33.3 Hz 6.8 G 2 hrs. each in X, Y directions 4 hrs. in Z direction based upon JIS D 1601
Impact resistance	30 G 3 times each in X, Y, Z directions
Enclosure	IP-67 (IEC Standard) ⁽²⁾
Extension Cable (Option)	CE1-R* 5 m, 10 m, 15 m, 20 m

Note 1) This includes the digital display error of the counter (CEU5).

When strokes are over 100 mm, accuracy is ±0.05 mm.

Moreover, the overall accuracy after mounting on equipment will vary depending on mounting conditions and the environment. Therefore, the customer should calibrate the equipment as a whole.

Note 2) Except for the connector, the cylinder section is the equivalent of an SMC water resistant cylinder.

Cylinder Stroke

Model	Standard stroke (mm)				Manufacturable* stroke range
	25	50	75	100	
CEP1B12	●	●	●	●	1 to 150
CEP1B20	●	●	●	●	1 to 300

* Strokes other than standard strokes are available upon request for special. Consult with SMC separately.



Precautions

Refer to page 646 before handling the products.

Weight (Sensor cable length 0.5 m, With connector, Without mounting bracket (both ends tapped))

Bore size (mm)	Cylinder stroke (mm)			
	25	50	75	100
12	0.36	0.4	0.44	0.48
20	0.56	0.62	0.68	0.74

Note) For the type with a sensor cable length of 0.5m and without connector (CE1□□□Z), 40g is subtracted from the weight shown above.
For the type with a sensor cable length of 3m and connector (CE1□□□L), add 160g to the weight shown above.
For the type with a sensor cable length of 3m and without connector (CE1□□□ZL), add 120g to the weight shown above.

Mounting Bracket (kg)

	12	20
Rod side flange (F)	0.045	0.1
Foot (L)	0.035	0.045

Note 1) Including mounting bolt.

Note 2) The foot shows the weight for one set (2 pcs.).

Rod End Nut Dimensions

(2 pcs. are attached as standard.)

Material ϕ 12, 20: Steel

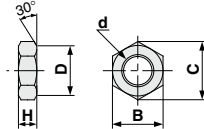

Part no.	Applicable bore size (mm)	d	H	B	C	D
DA00032	12	M5 x 0.8	3	8	9.2	7.8
DA00040	20	M8 x 1.25	5	13	15.0	12.5

Electrical Wiring

Output type

The output signal of the high precision stroke reading cylinder is A/B phase difference output (open collector output) as shown in the figure below.

The relation between the movement distance and the signal output of the high precision stroke reading cylinder is that for each 0.04 mm of movement a one pulse signal is output to both output terminals A and B. In order to measure with a discrimination of 0.01 mm, a counter with a 4 times multiplication function (CEU5) is required.

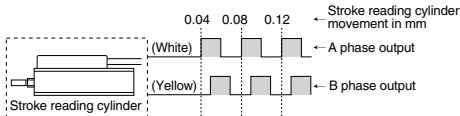

Input/Output

The input/output of the stroke reading cylinder is performed by a ϕ 7 shielded twisted pair wire from the sensor section plus a connector.

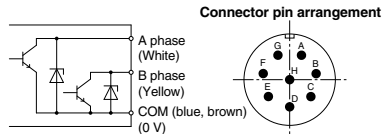

Output circuit of stroke reading cylinder

Signal

Contact signal	Wire color	Signal name
A	White	A phase
B	Yellow	B phase
C	Brown	COM (0 V)
D	Blue	COM (0 V)
E	Red	+12 to 24 V
F	Black	0 V
G	—	Shield

CEP1

CE1

CE2

ML2B

D-□

-X□

CEP1 Series

Construction

ø12, ø20

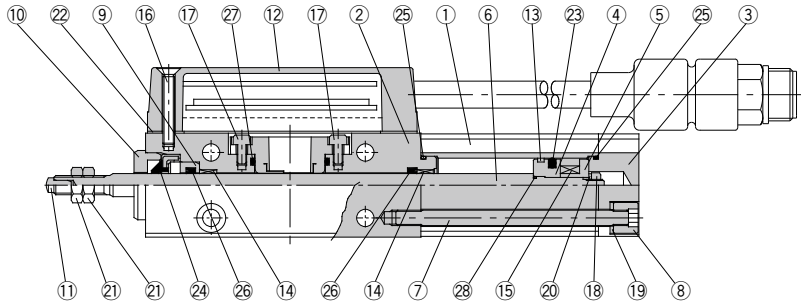

Component Parts

No.	Description	Material	Note
1	Cylinder tube	Aluminum alloy	Hard anodized
2	Rod cover	Aluminum alloy	Hard chrome plated
3	Head cover	Aluminum alloy	Hard anodized
4	Piston A	Aluminum alloy	Hard anodized
5	Piston B	Aluminum alloy	Hard anodized
6	Piston rod	Carbon steel	Hard chrome plated
7	Tie-rod	Carbon steel	Chromated
8	Tie-rod nut	Carbon steel	Chromated
9	Seal ring	Aluminum alloy	White anodized
10	Centering location ring	Aluminum alloy	White anodized
11	Rod end pin	Stainless steel	Quenched
12	Sensor unit	—	With or without connector
13	Wear ring	Special resin	
14	Bushing	Cast iron	

Component Parts

No.	Description	Material	Note
15	Magnet	—	
16	Cross recessed countersunk head screw	Chromium molybdenum steel	Chromated
17	Hexagon socket head cap screw	Stainless steel	
18	Hexagon nut	Carbon steel	Chromated
19	Spring washer	Steel wire	Chromated
20	Spring washer	Steel wire	Chromated
21	Hexagon nut	Carbon steel	Rod end nut
22	Sensor case gasket	NBR	
23	Piston seal	NBR	
24	Scraper	NBR	
25	Tube gasket	NBR	
26	Rod seal	NBR	
27	O-ring	NBR	
28	O-ring	NBR	

* Since there is a possibility of improper operation, please contact SMC regarding the replacement of seals.

Dimensions: $\phi 12$

Direct mounting, rod side tapped type:

CEP1B12 — **Stroke**

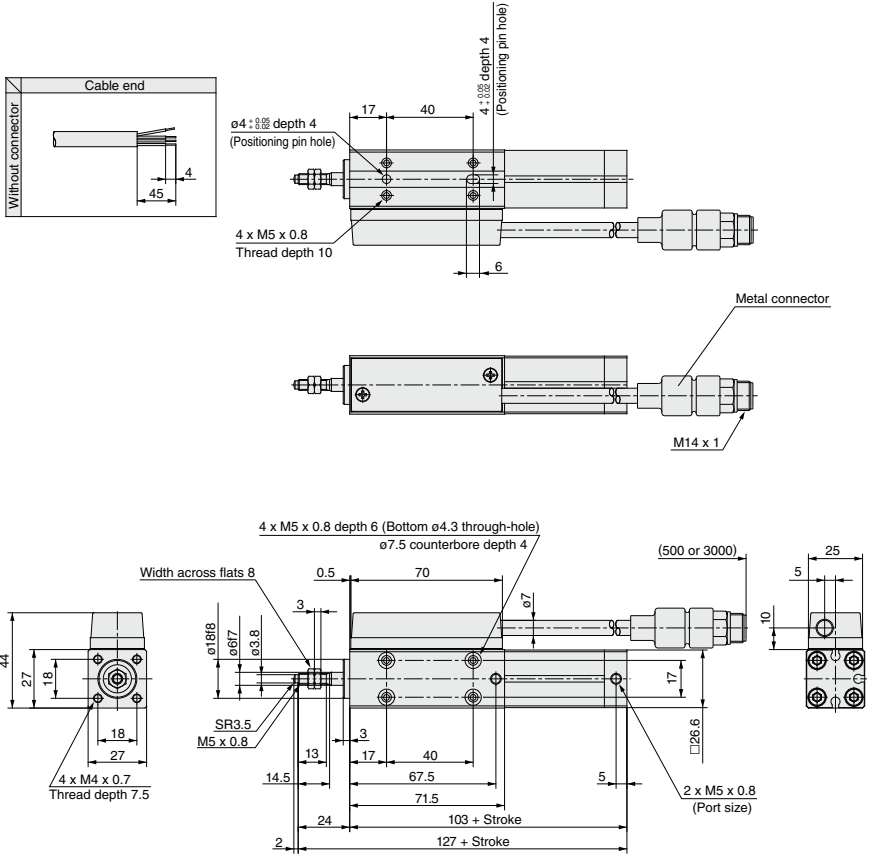

CEP1

CE1

CE2

ML2B

D-

-X

CEP1 Series

Dimensions: $\varnothing 12$

Foot type:

CEP1L12 — Stroke

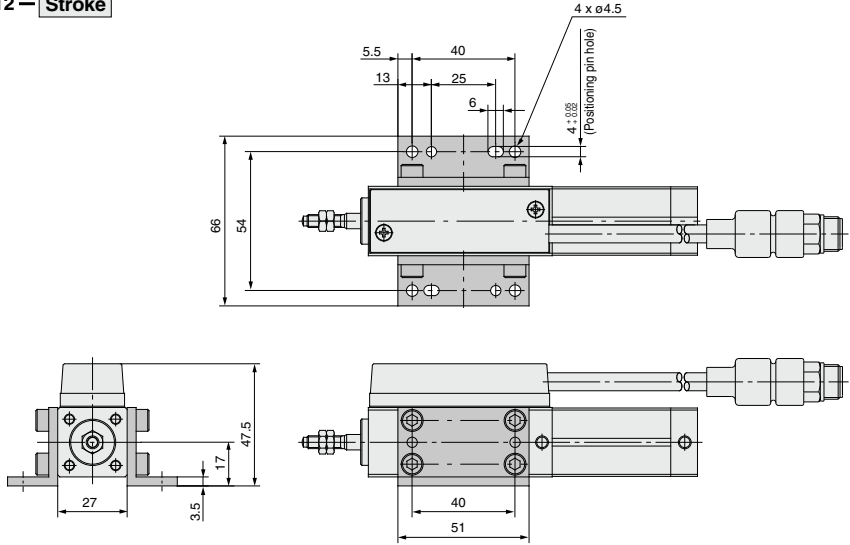

Rod side flange type:

CEP1F12 — Stroke

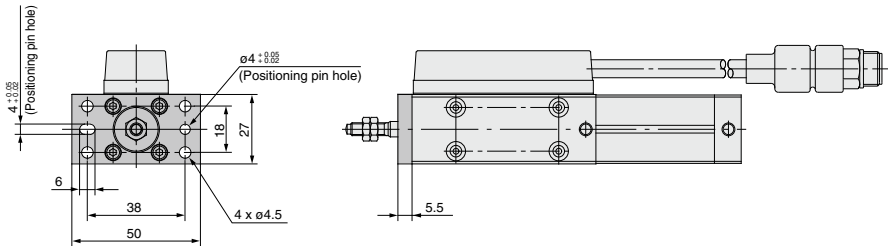

Dimensions: $\varnothing 20$

Direct mounting, rod side tapped type:

CEP1B20 — **Stroke**

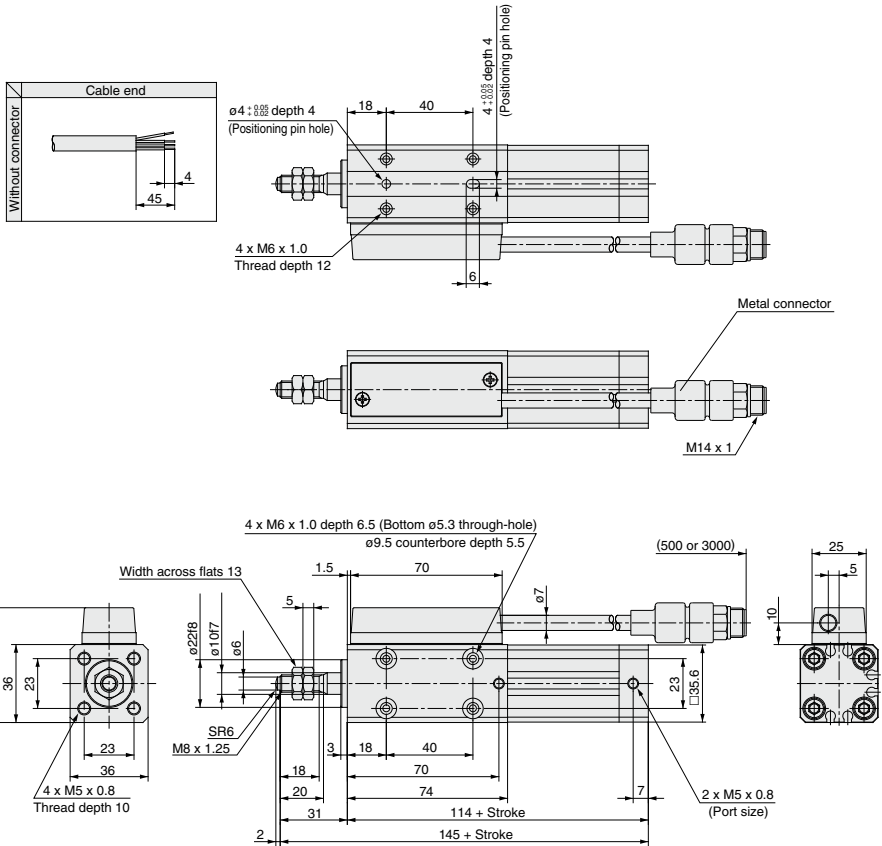

CEP1

CE1

CE2

ML2B

D-□

-X□

CEP1 Series

Dimensions: $\varnothing 20$

Foot type:

CEP1L20 — **Stroke**

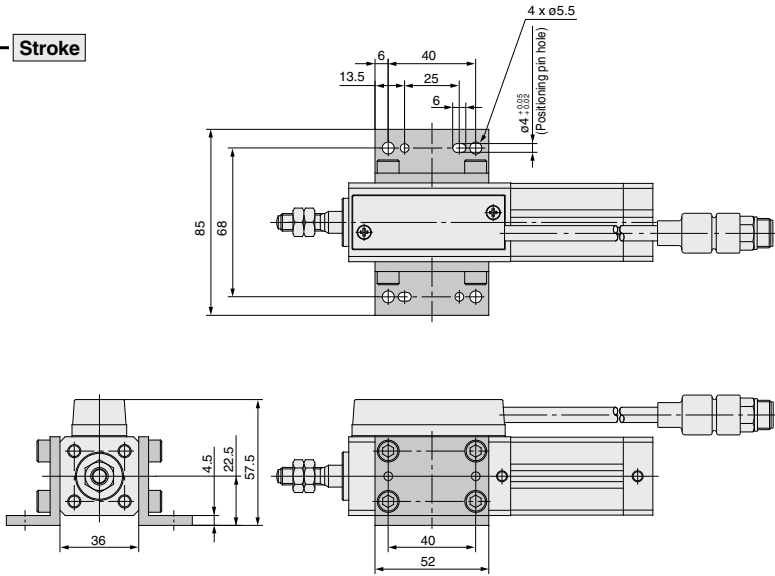

Rod side flange type:

CEP1F20 — **Stroke**

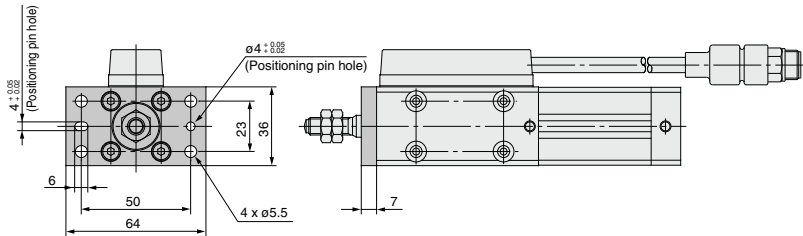

CEP1 Series Auto Switch Mounting

Auto Switch Proper Mounting Position (Detection at Stroke End)

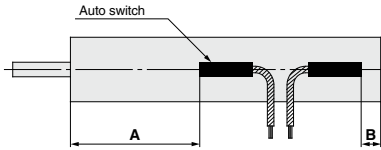

Auto Switch Proper Mounting Position (mm)

Auto switch model	Bore size			
	D-A9□ D-A9□V		D-M9□ D-M9□V D-M9□W D-M9□WV D-M9□A D-M9□AV	
Bore size	A	B	A	B
12	75	8	79	12
20	82	12	86	16

Note) Adjust the auto switch after confirming the operating conditions in the actual setting.

Operating Range

Auto switch model	Bore size (mm)	
	12	20
D-A9□/A9□V	6	10
D-M9□/M9□V D-M9□W/M9□WV D-M9□A/M9□AV	3	4

* Since the operating range is provided as a guideline including hysteresis, it cannot be guaranteed (assuming approximately $\pm 30\%$ dispersion). It may vary substantially depending on an ambient environment.

Other than the models listed in "How to Order", the following auto switches are applicable.

- * For solid state auto switches, auto switches with a pre-wired connector are also available. Refer to pages 1014 and 1015 for details.
- * Normally closed (NC = b contact), solid state auto switch (D-F9G/F9H type) are also available. For details, refer to page 959.

CEP1

CE1

CE2

ML2B

D-□

-X□

Stroke Reading Cylinder

CE1 Series

ø12, ø20, ø32, ø40, ø50, ø63



Note) CE-compliant: When connected to a multi-counter (CEU5□□-D, power supply voltage 24 VDC). Refer to the counter operation manual for details.



How to Order

CE1 L 32 - 200 - M9BW

Mounting type

B	Both ends tapped type (Standard)
L	Foot type
F	Rod side flange type
G	Head side flange type
D	Double clevis type

Bore size

12	12 mm
20	20 mm
32	32 mm
40	40 mm
50	50 mm
63	63 mm

Cable length

Nil	0.5 m
L	3 m

Auto switch

Nil	Without auto switch (Built-in magnet)
-----	---------------------------------------

* For the applicable auto switch model, refer to the table below.

Connector

Nil	With connector
Z	Without connector

Number of auto switches

Nil	2 pcs.
S	1 pc.
3	3 pcs.
n	"n" pcs.

Standard cylinder stroke (mm)
Refer to "Standard Stroke" on page 657.

Suffix for cylinder
(Applicable bore size ø40 to ø63)

Nil	With cushion on both ends
N	Without cushion
R	With cushion on rod end
H	With cushion on head end

Applicable counter
CEU5 series

<Option>

Extension cable CE1-R 05

Cable length

05	5 m
10	10 m
15	15 m
20	20 m

Suffix

Nil	Extension cable
C	Extension cable & connector

* ø12, ø20, ø32: Without cushion only. But, symbol N is not necessary.

Applicable Auto Switches

Refer to pages 941 to 1067 for further information on auto switches.

Type	Special function	Electrical entry	Indicator light	Wiring (Output)	Load voltage		Auto switch model		Lead wire length (m)					Pre-wired connector	Applicable load			
					DC	AC	Perpendicular	In-line	0.5 (Nil)	1 (M)	3 (L)	5 (Z)	None (N)					
Solid state auto switch	—	Grommet	Yes	3-wire (NPN)	5 V, 12 V	—	M9NV	M9N	●	●	○	—	—	—	IC circuit	Relay, PLC		
				3-wire (PNP)			M9PV	M9P	●	●	○	—	—					
		Connector		2-wire	12 V	—	J79C	—	—	—	—	—	—	—			—	—
				3-wire (NPN)	5 V, 12 V	—	M9NVW	M9NW	●	●	○	—	—	—			—	—
	Diagnostic indication (2-color indicator)	Grommet	Yes	3-wire (PNP)	5 V, 12 V	—	M9PWV	M9PW	●	●	○	—	—	—	—		—	
				2-wire			12 V	—	M9BWW	M9BW	●	●	○	—	—		—	
		Connector		3-wire (NPN)	5 V, 12 V	—	M9NAV*1	M9NA*1	○	○	●	—	—	—	—		—	
				3-wire (PNP)	5 V, 12 V	—	M9PAV*1	M9PA*1	○	○	●	—	—	—	—		—	
Water resistant (2-color indicator)	Grommet	Yes	2-wire	12 V	—	M9BAV*1	M9BA*1	○	○	●	—	—	—	—	—			
			4-wire	5 V, 12 V	—	—	F79F	●	—	○	—	—	—	—	—			
	Connector		3-wire (NPN equivalent)	5 V	—	A96V	A96	●	—	○	—	—	—	—	—			
			2-wire	—	200 V	A72	A72H	●	—	○	—	—	—	—	—			
Reed auto switch	—	Grommet	Yes	3-wire (NPN equivalent)	5 V	—	A96V	A96	●	—	○	—	—	—	—			
					12 V	100 V	A93V*2	A93	●	●	—	—	—	—	—			
		Connector		5 V, 12 V	100 V or less	A90V	A90	●	—	○	—	—	—	—	—			
				12 V	—	A73C	—	●	—	○	—	—	—	—	—			
Grommet	Yes	2-wire	5 V, 12 V	24 V or less	A80C	—	●	—	○	—	—	—	—	—				
			—	—	A79W	—	●	—	○	—	—	—	—					

*1 Water resistant type auto switches can be mounted on the above models, but in such case SMC cannot guarantee water resistance.

Consult with SMC regarding water resistant types with the above model numbers.

*2 1 m type lead wire is only applicable to D-A93.

* Lead wire length symbols: 0.5 m Nil (Example) M9NV
 1 m M (Example) M9NVW
 3 m L (Example) M9NVWL
 5 m Z (Example) M9NVWZ
 None N (Example) J79CN

* Solid state auto switches marked with "○" are produced upon receipt of order.

* Refer to page 666 for details on other applicable auto switches than listed above.

* For details about auto switches with pre-wired connector, refer to pages 1014 and 1015.

* When D-A93□(V)/M9□(V)/M9□W(V)/M9□A(V)L types with ø32 to ø63 are mounted on a side other than the port side, order auto switch mounting brackets separately. Refer to page 666 for details.

* Auto switches are shipped together (not assembled).

Cylinder Specifications



Fluid	Air	
Proof pressure	1.5 MPa	
Maximum operating pressure	1.0 MPa	
Minimum operating pressure	ø12	ø20 to ø63
	0.07 MPa	0.05 MPa
Piston speed	70 to 500 mm/s	
Ambient and fluid temperature	0 to 60°C (No freezing)	
Humidity	25 to 85% RH (No condensation)	
Lubrication	Non-lube	
Stroke length tolerance range	ø12, ø20: $\begin{matrix} +1.0 \\ 0 \end{matrix}$	ø32, ø40, ø50, ø63: $\begin{matrix} +1.6 \\ 0 \end{matrix}$
	ø12, ø20, ø32...None	ø40, ø50, ø63...With
With Air cushion	ø12	ø20
	ø32, ø40, ø50, ø63	
	±2°	±1°
Rod non-rotating accuracy	±0.8°	
Mounting	Both ends tapped type (Standard), Foot type, Flange type, Double clevis type	
Auto switch	Reed type, Solid state type	

CEP1

CE1

CE2

ML2B

Symbol



Mounting Bracket Part No.

Bore size (mm)	Foot <small>Note 1)</small>	Flange	Double clevis
12	CQ-L012	CQ-F012	CQ-D012
20	CQ-L020	CQ-F020	CQ-D020
32	CQ-L032	CQ-F032	CQ-D032
40	CQ-L040	CQ-F040	CQ-D040
50	CQ-L050	CQ-F050	CQ-D050
63	CQ-L063	CQ-F063	CQ-D063

Note 1) When ordering the foot bracket, order 2 pcs. per cylinder.

Note 2) Parts belonging to each bracket are as follows.

Foot, Flange/Body mounting bolts
Double clevis/Clevis pin, type C retaining ring for shaft, Body mounting bolts

Sensor Specifications

Cable	ø7, 6 core twisted pair shielded wire (Oil, Heat & Flame resistant cable)
Maximum transmission distance	23 m (when using SMC cable and counter)
Position detection method	Magnetic scale rod
	Sensor head <Incremental type>
Magnetic field resistance	14.5 mT
Power supply	10.8 to 26.4 DC (Power supply ripple: 1% or less)
Current consumption	40 mA
Resolution	0.1 mm/pulse
Accuracy	±0.2 mm (at 20°C) (1)
Output type	Open collector (24 VDC, 40 mA)
Output signal	A/B phase difference output
Insulation resistance	50 MΩ or more (500 VDC measured via megohmmeter) (between case and 12E)
Vibration resistance	33.3 Hz, 6.8 G 2 hrs. each in X, Y directions 4 hrs. in Z direction based upon JIS D 1601
Impact resistance	30 G 3 times each in X, Y, Z directions
Enclosure	IP65 (IEC Standard) (2) Except connector part
Extension cable (Option)	5 m, 10 m, 15 m, 20 m

Note 1) This includes the digital display error of the counter (CEU5).

Moreover, the overall accuracy after mounting on equipment will vary depending on the mounting conditions and the environment. Therefore, the customer should calibrate the equipment as a whole.

Note 2) The cylinder section does not have a water resistant enclosure.

Cylinder Stroke

Bore size (mm)	Standard Stroke (mm)										Manufacturable stroke range		
	25	50	75	100	125	150	175	200	250	300		400	500
12	●	●	●	●	●	●	—	—	—	—	—	—	25 to 150
20	●	●	●	●	●	●	●	●	—	—	—	—	25 to 300
32	—	●	●	●	●	●	●	●	●	●	—	—	25 to 400
40	—	—	—	●	●	●	●	●	●	●	●	●	25 to 600
50	—	—	—	—	—	—	—	●	—	●	—	●	25 to 600
63	—	—	—	—	—	—	—	●	—	●	—	●	25 to 600

* Strokes other than standard strokes are available upon request for special. Consult with SMC separately.

Especially, be careful of an eccentric load applied to the rod when the stroke is over 100 mm with a bore size of 12 mm.

D-□

-X□



Precautions

Refer to page 646 before handling the products.

CE1 Series

Weight (Sensor cable length 0.5 m, With connector, Without mounting bracket (both ends tapped))

Bore size (mm)	Cylinder stroke (mm)											
	25	50	75	100	125	150	175	200	250	300	400	500
12	0.28	0.32	0.35	0.39	0.42	0.46	—	—	—	—	—	—
20	0.48	0.55	0.62	0.69	0.76	0.83	0.9	0.97	—	—	—	—
32	—	0.84	0.95	1.05	1.16	1.26	1.37	1.48	1.69	1.9	—	—
40	—	—	—	1.58	1.71	1.83	1.96	2.08	2.33	2.58	3.08	3.58
50	—	—	—	—	—	—	—	3.26	—	3.96	—	5.36
63	—	—	—	—	—	—	—	4.04	—	4.84	—	6.44

Note 1) For the type with a sensor cable length of 0.5m and without connector (CE1□□-□Z), 40g is subtracted from the weight shown above.
 For the type with a sensor cable length of 3m and connector (CE1□□-□L), add 160g to the weight shown above.
 For the type with a sensor cable length of 3m and without connector (CE1□□-□ZL), add 120g to the weight shown above.
 Note 2) The mounting bracket weight is shared with the compact cylinder (CQ2 series). So, refer to the CQ2 series catalog.

Auto Switch Proper Mounting Position

Regarding dimensions for the auto switch proper mounting position (at stroke end), refer to page 665.

Rod End Nut Dimensions

(1 pc. is attached as standard.)

Material $\phi 12, 20$: Steel
 $\phi 32$ to $\phi 63$: Rolled steel

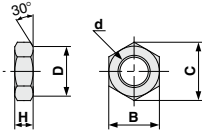

Part no.	Applicable bore size (mm)	d	H	B	C	D
NTJ-015A	12	M5 x 0.8	4	8	9.2	7.8
NT-02	20	M8 x 1.25	5	13	15.0	12.5
NT-04	32-40	M14 x 1.5	8	22	25.4	21.0
NT-05	50-63	M18 x 1.5	11	27	31.2	26

Electrical Wiring

Output type

The output signal of the stroke reading cylinder is A/B phase difference output (open collector output) as shown in the figure below.
 The relation between the movement distance and the signal output of the stroke reading cylinder is that for each 0.1 mm of movement a one pulse signal is output to both output terminals A and B.
 Furthermore, the maximum response speed of the sensor for the stroke reading cylinder is at a maximum cylinder speed of 1500 mm/s (15 kcps).

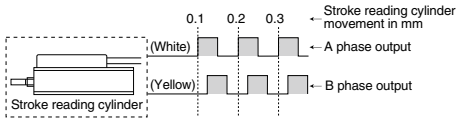

Input/Output

The input/output of the stroke reading cylinder is performed by a $\phi 7$ shielded twisted pair wire from the sensor section plus a connector.

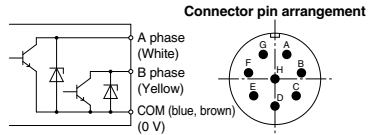

Output circuit of stroke reading cylinder

Signal

Contact signal	Wire color	Signal name
A	White	A phase
B	Yellow	B phase
C	Brown	COM (0 V)
D	Blue	COM (0 V)
E	Red	+12 to 24 V
F	Black	0 V
G	—	Shield

Construction

ø12, ø20

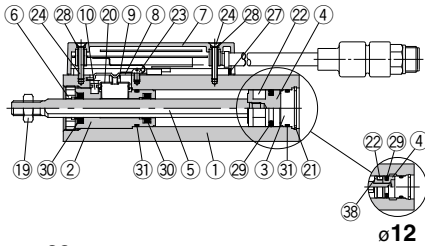

ø32

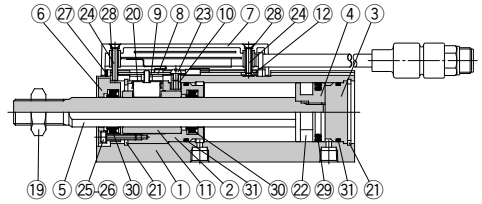

ø40 to ø63

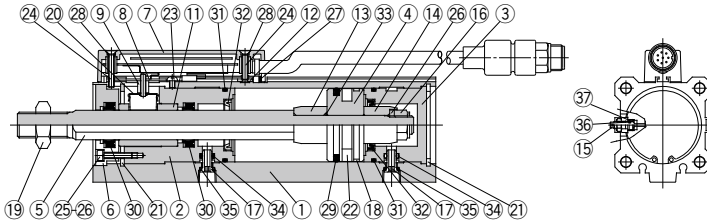

CEP1

CE1

CE2

ML2B

Component Parts

No.	Description	Material	Note
1	Cylinder body	Aluminum alloy Brass	ø12 to ø20
2	Rod cover	Aluminum alloy	ø32 to ø63
3	Head cover	Aluminum alloy	
4	Piston	Aluminum alloy	
5	Piston rod	Stainless steel	
6	Rod cover disk	Aluminum alloy	
7	Sensor unit	—	
8	Sensor setting bracket	Stainless steel	
9	Sensor setting piece assembly	—	ø20 to ø63
10	Pin	Stainless steel	ø12 to ø32
11	Sensor guide	Lead-bronze casted	ø32 to ø63
12	Case setting nut	Carbon steel	ø32 to ø63
13	Cushion ring A	Rolled steel	ø40 to ø63
14	Cushion ring B	Rolled steel	ø40 to ø63
15	Cushion valve	—	ø40 to ø63
16	Piston nut	Rolled steel	ø40 to ø63
17	Port joint	Stainless steel	ø40 to ø63
18	Wear ring	Resin	ø40 to ø63

Component Parts

No.	Description	Material	Note
19	Rod end nut	Carbon steel	
20	Sensor setting plate	Cold rolled special steel strip	
21	Type C retaining ring	Carbon steel	
22	Magnet	—	
23	Round head Phillips screw	Carbon steel wire	
24	Cross recessed countersunk head screw	Carbon steel wire	
25	Hexagon socket head cap screw	Chromium molybdenum steel	
26	Spring washer	Steel wire	
27	Case gasket	NBR	
28	Case screw gasket	NBR	
29	Piston seal	NBR	
30	Rod seal	NBR	
31	Gasket	NBR	
32	Cushion seal	NBR	
33	Piston gasket	NBR	
34	Port seal	NBR	
35	Joint seal	NBR	
36	Valve seal	NBR	
37	Valve retainer seal	NBR	
38	Spacer for switch type	Aluminum alloy	ø12

* Since there is a possibility of improper operation, please contact SMC regarding the replacement of seals.

D-□

-X□

CE1 Series

Dimensions: $\varnothing 12, \varnothing 20$

Both ends tapped type:

CE1B Bore size — Stroke

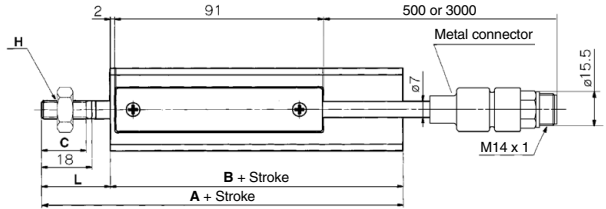
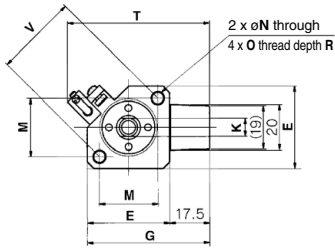
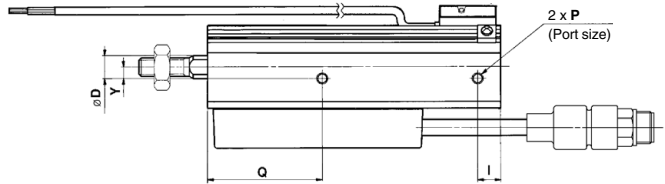

													(mm)
Bore size (mm)	Standard stroke		A	B	C	D	E	G	H	I	K	L	M
12	25, 50, 75, 100, 125, 150		93.5	69	15	6	25	42.5	M5 x 0.8	16	5.2	24.5	15.5
20	25, 50, 75, 100, 125, 150, 175, 200		106	78	15.5	10	36	53.5	M8 x 1.25	10	8	28	25.5
Bore size (mm)	N	O	P	Q	R	T*	V	Y					
12	—	M4 x 0.7	M5 x 0.8	47	7	53.5	22	7					
20	5.5	M6 x 1	M5 x 0.8	50	15	62.5	36	5					

* For rod end nut accessory bracket, refer to page 658. * Dimensions for auto switch model D-F79W.

Foot type:

CE1L **Bore size** — **Stroke**

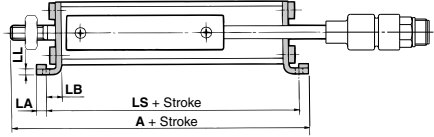
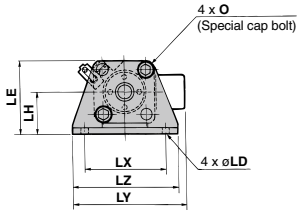

Rod side flange type:

CE1F **Bore size** — **Stroke**

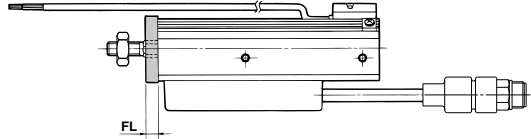
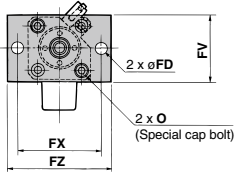

Head side flange type:

CE1G **Bore size** — **Stroke**

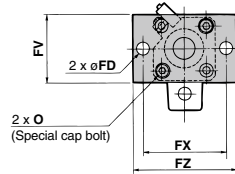
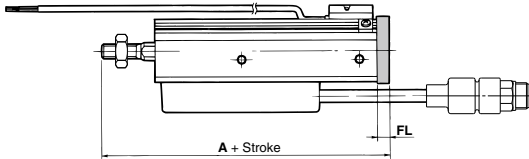

Double clevis type:

CE1D **Bore size** — **Stroke**

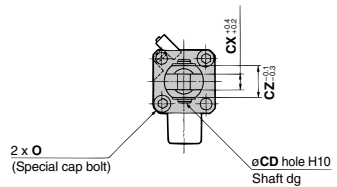
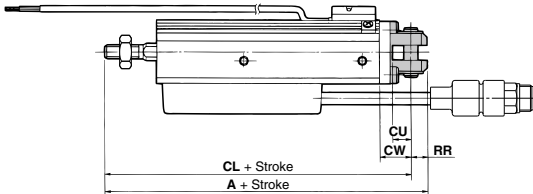

Bore size (mm)	Common	Foot type												Rod side flange, Head side flange					Head side flange					Double clevis type					
		A	LA	LB	LD	LE	LH	LL	LS	LX	LY	LZ	FD	FL	FV	FX	FZ	A	A	CD	CL	CU	CW	CX	CZ	RR			
12	M4 x 0.7	106	4.5	8	4.5	29.5	17	2	85	34	52	44	4.5	5.5	25	45	55	99	113.5	5	107.5	7	14	5	10	6			
20	M6 x 1	121	5.8	9.2	6.6	42	24	3.2	96.4	48	66.5	62	6.6	8	39	48	60	114	133	8	124	12	18	8	16	9			

CEP1

CE1

CE2

ML2B

D-□

-X□

CE1 Series

Dimensions: $\varnothing 32$, $\varnothing 40$, $\varnothing 50$, $\varnothing 63$

Both ends tapped type:

CE1B Bore size — Stroke

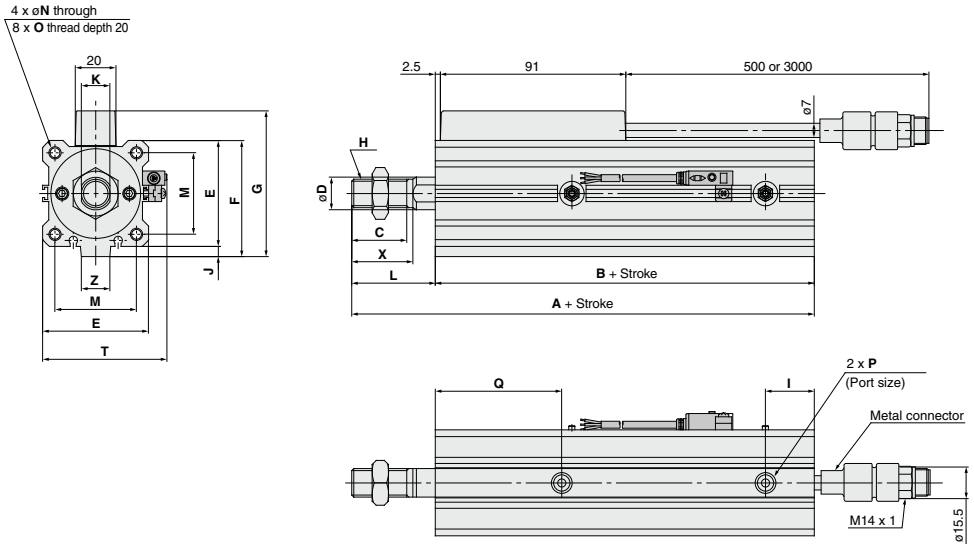

													(mm)		
Bore size (mm)	Standard stroke				A	B	C	D	E	F	G	H	I	J	K
32	50, 75, 100, 125, 150, 175, 200, 250, 300				131	90	27	16	45	49.5	64	M14 x 1.5	14	4.5	14
40	100, 125, 150, 175, 200, 250, 300, 400, 500				177	136	27	16	52	57	71.5	M14 x 1.5	24	5	14
50	200, 300, 500				193	144	32	20	64	71	85.5	M18 x 1.5	25.5	7	18
63	200, 300, 500				194	145	32	20	77	84	98.5	M18 x 1.5	21	7	18
Bore size (mm)	L	M	N	O	P	Q	T*	X	Z						
32	41	34	5.5	M6 x 1	Rc 1/8	56	57.5	30	14						
40	41	40	5.5	M6 x 1	Rc 1/8	62	64.5	30	14						
50	49	50	6.6	M8 x 1.25	Rc 1/4	61.5	76.5	35	19						
63	49	60	9	M10 x 1.5	Rc 1/4	64	89.5	35	19						

* For rod end nut accessory bracket, refer to page 658. * Dimensions for auto switch model D-F79W.

Foot type:

CE1L **Bore size** — **Stroke**

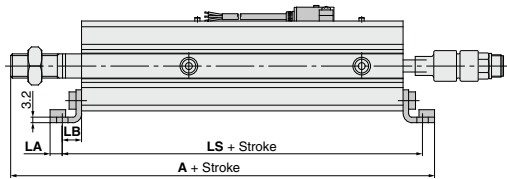
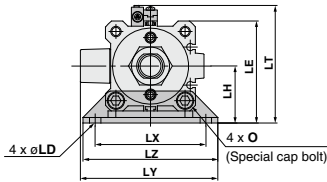

CEP1

CE1

CE2

ML2B

Rod side flange type:

CE1F **Bore size** — **Stroke**

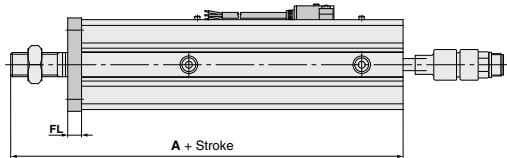
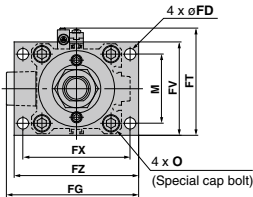

Head side flange type:

CE1G **Bore size** — **Stroke**

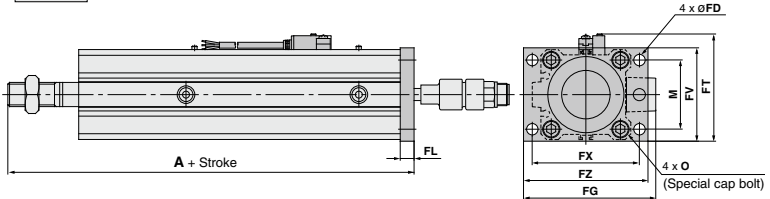

Double clevis type:

CE1D **Bore size** — **Stroke**

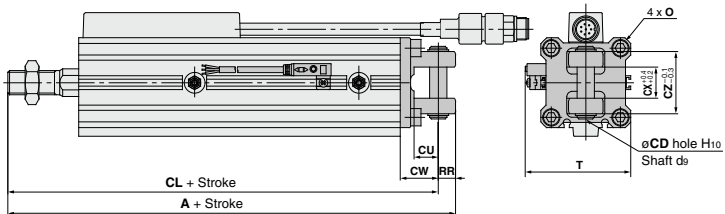

Bore size (mm)	Common	Foot type											Rod side flange, Head side flange						Double clevis type												
		O	A	LA	LB	LD	LE	LH	LS	LT*	LX	LY	LZ	FD	FG	FL	FT*	FV	FX	FZ	M	A	A	A	CD	CL	CU	CW	CX	CZ	RR
32	M6 x 1	148	5.8	11.2	6.6	62.5	30	112.4	65	57	72.5	71	5.5	69.5	8	59	48	56	65	34	131	139	161	10	151	14	20	18	36	10	57.5
40	M6 x 1	185.2	7	11.2	6.6	59	33	138.4	71.5	64	79.5	78	5.5	76.5	8	65.5	54	62	72	40	177	185	209	10	199	14	22	18	36	10	64.5
50	M8 x 1.25	215.7	8	14.7	9	71	39	173.4	83.5	79	94	95	6.6	91	9	78	67	76	89	50	193	202	235	14	221	20	28	22	44	14	76.5
63	M10 x 1.5	219.2	9	16.2	11	84.5	46	177.4	97	95	109.5	113	9	107	9	91	80	92	108	60	194	203	238	14	224	20	30	22	44	14	89.5

* Dimensions for auto switch model D-F79W.

D-□

-X□

CE1 Series

Auto Switch Mounting

Auto Switch Proper Mounting Position (Detection at Stroke End) and Its Mounting Height

- | | |
|--------|---------|
| D-A9□ | D-A9□V |
| D-M9□ | D-M9□V |
| D-M9□W | D-M9□WV |
| D-M9□A | D-M9□AV |

ø12 to ø20

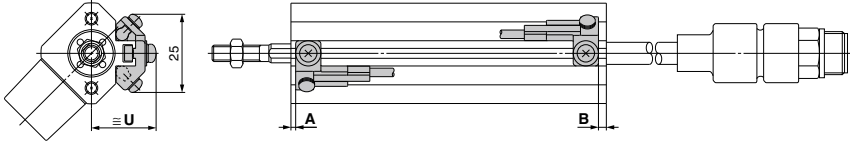

ø32 to ø63

- | | |
|--------|---------|
| D-A9□ | D-A9□V |
| D-M9□ | D-M9□V |
| D-M9□W | D-M9□WV |
| D-M9□A | D-M9□AV |

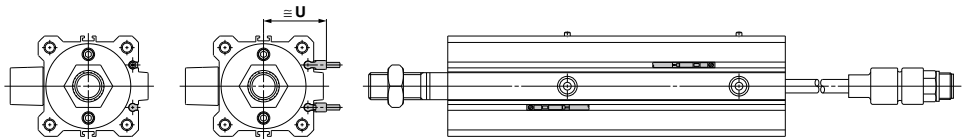

- | | |
|--------|---------|
| D-A7□ | D-F7NT |
| D-A80 | D-F7BA |
| D-A7□H | D-A73C |
| D-A80H | D-A80C |
| D-F7□ | D-J79C |
| D-J79 | D-A79W |
| D-F7□W | D-F7□WV |
| D-J79W | D-J7□V |
| D-F79F | D-F7BAV |

ø12 to ø20

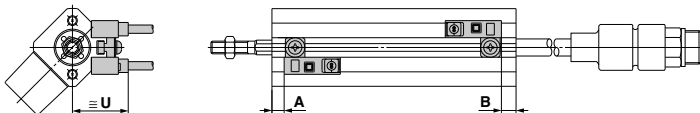

ø32 to ø63

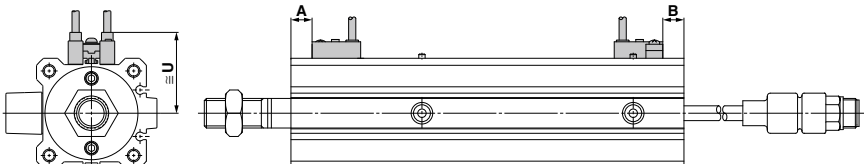

Auto Switch Proper Mounting Position (Detection at Stroke End) and Its Mounting Height

Auto Switch Proper Mounting Position

Auto switch model	D-A9□ D-A9□V		D-M9□ D-M9□V D-M9□W D-M9□WV D-M9□A D-M9□AV		D-A73 D-A80		D-A72/A7□H/A80H D-A73C/A80C/F7□ D-F79F/J79/F7□V D-J79C/F7□W D-J79W/F7□WV D-F7BAV/F7BA		D-F7NT		D-A79W	
	A	B	A	B	A	B	A	B	A	B	A	B
12	37	5.5	41	9.5	38	6.5	38.5	7	43.5	12	35.5	4.5
20	46	12	50	16	47	13	47.5	13.5	52.5	18.5	44.5	10.5
32	54	16	58	20	55	17	55	17.5	60.5	22.5	52.5	14.5
40	78	38	82	42	79	39	79.5	39.5	84.5	44.5	76.5	36.5
50	81	43	85	47	82	44	82.5	44.5	87.5	49.5	79.5	41.5
63	84.5	40.5	88.5	44.5	85.5	41.5	86	42	91	47	83	39

Note) Adjust the auto switch after confirming the operating conditions in the actual setting.

Auto Switch Mounting Height

Auto switch model	D-A9□V		D-M9□V D-M9□WV D-M9□AV		D-A7□ D-A80		D-A7□H D-A80H D-F7□ D-J79 D-F7□W D-J79W D-F7BA D-F79F D-F7NT		D-A73C D-A80C		D-F7□V D-F7□WV D-F7BAV		D-J79C		D-A79W	
	U		U		U		U		U		U		U		U	
12	20.5		20.5		19.5		20.5		26.5		23		26		22	
20	25.5		25.5		24.5		25.5		31.5		28		31		27	
32	27		29		31.5		32.5		38.5		35		38		34	
40	30.5		32.5		35		36		42		38.5		41.5		37.5	
50	36.5		38.5		41		42		48		44.5		47.5		43.5	
63	40		42		47.5		48.5		54.5		51		54		50	

* Auto switch mounting brackets BQ2-012 are not used for sizes over φ32 of D-A9□V/M9□V/M9□WV/M9□AVL types. In that case, the above values indicate the operating range when mounted with the current auto switch installation groove.

Minimum Auto Switch Mounting Stroke

No. of auto switches mounted	D-M9□V D-F7□V D-J79C	D-A9□V D-A7□ D-A80 D-A73C D-A80C	D-A9□	D-M9□WV D-M9□AV D-F7□WV D-F7BAVL	D-M9□ D-F7□ D-J79	D-M9□W D-M9□A	D-A7□H D-A80H	D-A79W	D-F7□W D-J79W D-F7BA D-F79F D-F7NT
1 pc.	5	5	10 (5)	10	15 (5)	15 (10)	15 (5)	15	20 (10)
2 pcs.	5	10	10	15	15 (5)	15	15 (10)	20	20 (15)

Note) The dimensions stated in () shows the minimum stroke for the auto switch mounting when the auto switch does not project from the end surface of the cylinder body and hinder the lead wire bending space. (Refer to the figure below.)
Order auto switches and auto switch mounting brackets separately.



Operating Range

Auto switch model	Bore size (mm)					
	12	20	32	40	50	63
D-A9□(V)	7	9	9.5	9.5	9.5	11.5
D-M9□(V) D-M9□W(V) D-M9□A(V)	2.5	4	6	6	6	6.5
D-A7□(H)(C) D-A80□(H)(C)	9.5	12	12	11	10	12
D-A79W	11.5	13	13	14	14	16
D-F7□(V) D-J79(C) D-F7□W(V) D-F7BA(V) D-F7NT D-F79F	4	5.5	6	6	6	6.5

* Since the operating range is provided as a guideline including hysteresis, it cannot be guaranteed (assuming approximately ±30% dispersion). It may vary substantially depending on an ambient environment.

CEP1

CE1

CE2

ML2B

D-□

-X□

CE1 Series

Auto Switch Mounting Bracket: Part No.

Auto switch mounting surface	Bore size (mm)	
	ø12, ø20	ø32, ø40, ø50, ø63
Auto switch model	Auto switch mounting surface	Auto switch mounting surface
	Auto switch mounting rail side only	Port side A, B, C
① BQ-1 ② BQ2-012 Two kinds of auto switch mounting brackets are used as a set. D-A9□ D-A9□V D-M9□ D-M9□V D-M9□W D-M9□WV D-M9□A D-M9□AV	 Set screw (not used) Auto switch mounting brackets are not required.	① BQ-2 ② BQ2-012 Two kinds of auto switch mounting brackets are used as a set. Set screw (not used)

Note 1) When a compact auto switch is mounted on the three sides (A, B and C above) other than the port side of CE1□32 to 50, the auto switch mounting brackets above are required. Order them separately from cylinders.

(It is the same as when mounting compact cylinders with an auto switch mounting rail, but not with CE1□63 to 100 compact auto switch installation groove.)

Example order:

CE1B32-100-M9BW 1 unit
 BQ-2 2 pcs.
 BQ2-012 2 pcs.

Note 2) Auto switch mounting brackets and auto switches are shipped together with cylinders.

Note 3) D-A9□ and D-A9□V auto switches cannot be used with the product with a bore size of ø12 (CE1□12).

Auto switch model	Bore size (mm)	
	ø12 to ø20	ø32, ø40 to ø63
D-A7□/A80 D-A73C/A80C D-A7□H/A80H D-A79W D-F7□/J79 D-F7□V D-J79C D-F7□W/J79W D-F7□WV D-F7BA/F7BAV D-F79F/F7NT	BQ-1	BQ-2

Note 4) Auto switch mounting brackets and auto switches are shipped together with cylinders.

[Mounting screw set made of stainless steel]

The following set of mounting screws made of stainless steel (including nuts) is available. Use it in accordance with the operating environment. (Please order BQ-2 separately, since the auto switch spacer (for BQ-2) is not included.)

BBA2: For D-A7/A8/F7/J7 types

D-F7BA/F7BAV auto switches are set on the cylinder with the stainless steel screws above when shipped.

When an auto switch is shipped independently, BBA2 is attached.

Note 5) Refer to page 1051 for the details of BBA2.

Note 6) When mounting D-M9□A(V) on a port other than the ports for ø32, ø40 and ø50, order auto switch mounting brackets BQ2-012S, BQ-2 and stainless steel screw set BBA2 separately.

Auto Switch Mounting Bracket Weight

Auto switch mounting bracket part no.	Applicable bore size	Weight (g)
BQ-1	ø12 to ø20	1.5
BQ-2	ø32 to ø63	1.5
BQ2-012	ø12 to ø63	5

Other Applicable Auto Switches

Auto switch type	Model	Electrical entry (Fetching direction)	Features
Reed	D-A73	Grommet (Perpendicular)	—
	D-A80		Without indicator light
	D-A73H, A76H	Grommet (In-line)	—
	D-A80H		Without indicator light
Solid state	D-F7NV, F7PV, F7BV	Grommet (Perpendicular)	—
	D-F7NWW, F7BWW		Diagnostic indication (2-color indicator)
	D-F7BAVL		Water resistant (2-color indicator)
	D-F79, F7P, J79	Grommet (In-line)	—
	D-F79W, F7PW, J79W		Diagnostic indication (2-color indicator)
	D-F7BA		Water resistant (2-color indicator)
	D-F7NT		With timer

* For solid state auto switches, auto switches with a pre-wired connector are also available. Refer to pages 1014 and 1015 for details.

* Normally closed (NC = b contact), solid state auto switch (D-F9G/F9H type) are also available. For details, refer to page 959.

CEU Series CE Series Counter/Extension Cable



Note) CE-compliant: When connecting to a stroke reading cylinder (CE1), a high precision stroke reading cylinder (CEP1) and a stroke reading cylinder with brake (CE2), (CEU□□-D type)
Refer to the operation manual for details.



■ Multi-counter

How to Order



- CEP1
- CE1
- CE2
- ML2B

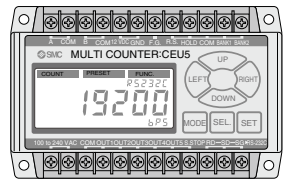
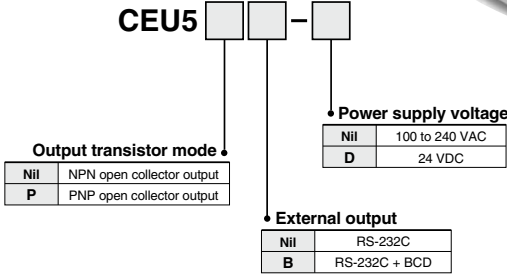

Connection Method

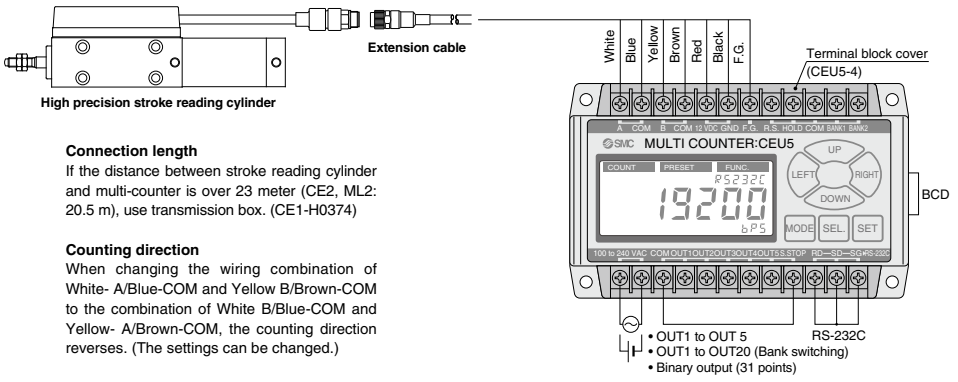

Connection length
If the distance between stroke reading cylinder and multi-counter is over 23 meter (CE2, ML2: 20.5 m), use transmission box. (CE1-H0374)

Counting direction
When changing the wiring combination of White- A/Blue-COM and Yellow B/Brown-COM to the combination of White B/Blue-COM and Yellow- A/Brown-COM, the counting direction reverses. (The settings can be changed.)

BCD output (Refer to page 676.) function is available only for CEU5□□B-□.

(1) BCD output connector: D-Sub half pitch connector
D x 10M-36S (Made by HIROSE ELECTRIC CO., LTD.)

(2) Applicable connectors: D x 30AM-36P (Plug: Made by HIROSE ELECTRIC CO., LTD.) *
D x 30M-36-CV (Cover: Made by HIROSE ELECTRIC CO., LTD.) *
Other interchangeable commercial cables with connectors can be also used.

* Pressure welding tools are required to connect the connector (plug, cover) models listed above and cables (order separately). The following products, including pre-assembled connectors and cables, are also available. Contact the manufacturer (Misumi Corporation) directly.
SHPT-H-A-36-*: Male connector on one end, cable cut off on one end
SHPT-HH-A-36-*: Male connectors on both ends
* 0.2 to 50 (This shows the cable length. Unit: m)

- D-□
- X□



Multi-counter/Specifications

Model	CEU5	CEU5-D	CEU5P	CEU5P-D	CEU5B	CEU5B-D	CEU5PB	CEU5PB-D
Type	Multi-counter							
Mounting	Surface mounting (DIN rail or Screw stop)							
Operating system	Adding - subtracting type							
Operation mode	Operating mode, Data setting mode, Function setting mode							
Reset system	External reset terminal							
Display system	LCD (With back light)							
Number of digits	6 digits							
Memory holding (Storage medium)	Setting value (always held), Count value (Hold/Non-hold switching), (E ² ROM (Warning display after writing approx. 800,000 times: E2FUL))							
Input signal type	Count input, Control signal input (Reset, Hold, Bank selection)							
Count input	No-voltage pulse input							
Pulse signal system	90° phase difference input *1/ UP/DOWN separate input *2							
Counting speed	100 kHz *1							
Control signal input	Voltage input (12 VDC or 24 VDC)							
Sensor power supply	10.8 to 13.2 VDC, 60 mA							
Output signal type	Preset output, Cylinder stop output				Preset output, Cylinder stop output, BCD output			
Preset output configuration	Compare/Hold/One-shot (100 ms fixed pulse)							
Output type	Separate 5 point output/Binary code output							
Output delay time	5 ms or less (for normal output)/60 ms or less (Binary output)							
Communication system	RS-232C							
Output transistor mode	NPN open collector Max 30 VDC, 50 mA		PNP open collector Max 30 VDC, 50 mA		NPN open collector Max 30 VDC, 50 mA *3		PNP open collector Max 30 VDC, 50 mA *3	
Power supply voltage	90 to 264 VAC	21.6 to 26.4 VDC	90 to 264 VAC	21.6 to 26.4 VDC	90 to 264 VAC	21.6 to 26.4 VDC	90 to 264 VAC	21.6 to 26.4 VDC
Power consumption	20 VA or less	10 W or less	20 VA or less	10 W or less	20 VA or less	10 W or less	20 VA or less	10 W or less
Withstand voltage	Between case and AC line: 1500 VAC for 1 min. Between case and signal ground: 500 VAC for 1 min.							
Insulation resistance	Between case and AC line: 50 MΩ or more (500 VDC measured via megohmmeter)							
Ambient temperature	0 to +50°C (No freezing)							
Ambient humidity	35 to 85% RH (No condensation)							
Noise resistance	Square wave noise from a noise simulator (pulse duration 1 μs) between power supply terminals ±2000 V, I/O line ±600 V							
Shock resistance	Endurance 10 to 55 Hz; Amplitude 0.75 mm; X, Y, Z for 2 hours each							
Impact resistance	Endurance 10 G; X, Y, Z directions, 3 times each							
Weight	350 g or less							

*1) 90° phase difference input

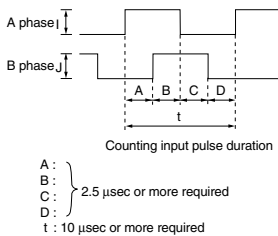

$$\text{Counting speed } f = \frac{1}{t} = \frac{1}{10 \times 10^{-6}} = 100000 \text{ Hz} \approx 100 \text{ kHz}$$

*2) UP/DOWN input

Input wave form conditions: At a maximum of 100 kHz, the UP/DOWN wave form should be as shown below.

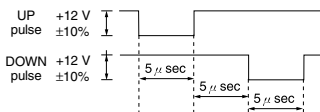

*3) 15 mA when BCD is output (Refer to page 676.)

Multi-counter/Dimensions

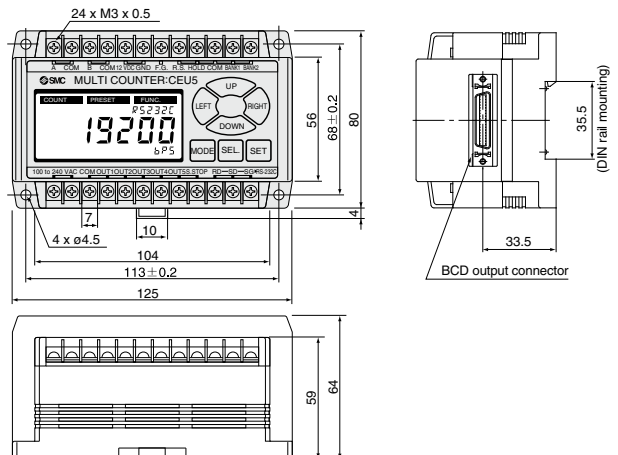

Wiring with External Equipment

<Wiring with multi-counter CEU5>

1. Wiring of power source for driving counter

For power source for driving counter, use the one with 90 to 264 VAC, 50/60 Hz or 21.6 to 26.4 VDC, 0.4 A or more.

2. Wiring for control signal input

(Selection among Reset, Hold, Bank (Refer to page 676.)) Make each control signal to be the transistor which can run more than 15 mA or the contact output. Input time for reset signal should be more than 10 ms. Bank (Refer to page 676.) selection and hold will function only when the input signal is applied.

COM is common to each signal input. Applicable to NPN and PNP input. Use 24 VDC or 12 VDC for the power source of COM. Connect DC- when PNP is applied, and DC+ when NPN is applied.

CEU5 Control signal input

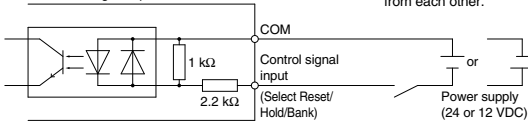

3. Output circuit

There are two outputs, the NPN open collector and the PNP open collector.

The maximum rating is 30 VDC, 50 mA. Operating the controller by exceeding this voltage and amperage could damage the electric circuit.

Therefore, the equipment to be connected must be below this rating.

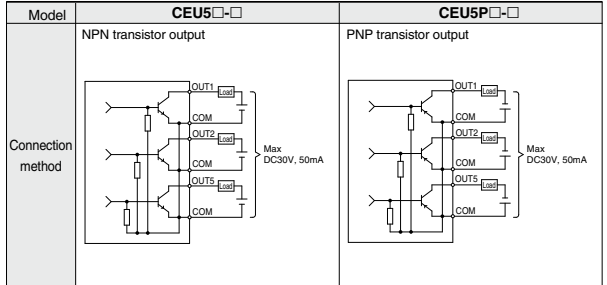

* However, the COM of the input circuit and the COM of the output circuit are electrically insulated from each other.

CEP1

CE1

CE2

ML2B

Extension Cable

How to Order

CE1-R □ □

Cable length

05	5 m
10	10 m
15	15 m
20	20 m

Suffix

Nil	Extension cable
C	Extension cable & connector

Extension cable

CE1-R□



Stroke reading cylinder side connector (unit)

CE1-R00C



R04-J8M7.3

(Made by Tajimi Electronics Co., Ltd.)

CE1-R□C



D-□

-X□

Operating Condition of each Output Mode

One-shot Output

Without allowable values	With allowable values
<p>When the counter value passes the preset value, output is turned ON for 100 ms.</p>	<p>When the counter value passes the sum of the preset value + the allowed value, output is turned ON for 100 ms.</p>

Hold Output

Without allowable values	With allowable values
<p>When the counter value passes the preset value, output is turned ON and that state is maintained. Output is cancelled when the power is turned off, the reset signal is input or when the setting value is changed.</p>	<p>When the counter value passes the sum of the preset value + the allowed value, output is turned ON. Output is cancelled when the power is turned off, the reset signal is input or when the setting value is changed.</p>

Compare Output

Without allowable values	With allowable values
<p>Output is turned ON only when the counter value coincides with the preset value.</p>	<p>When the counter value passes the sum of the preset value + the allowed value, output is turned ON.</p>

CEP1

CE1

CE2

ML2B

D-□

-X□

CEU5 Operation

Parts description

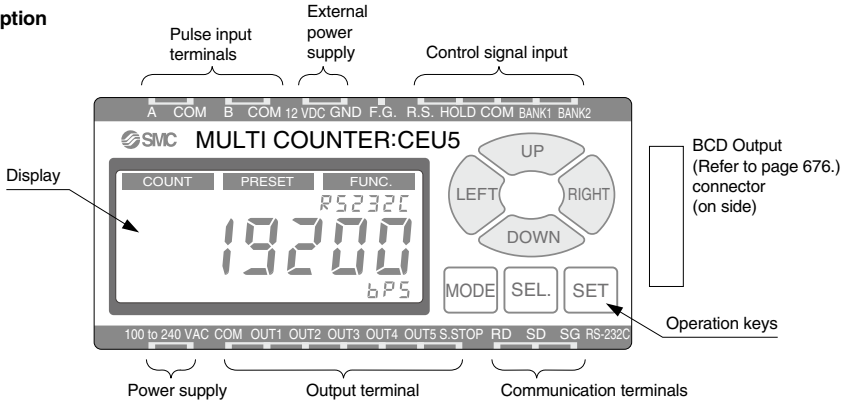

Display detail

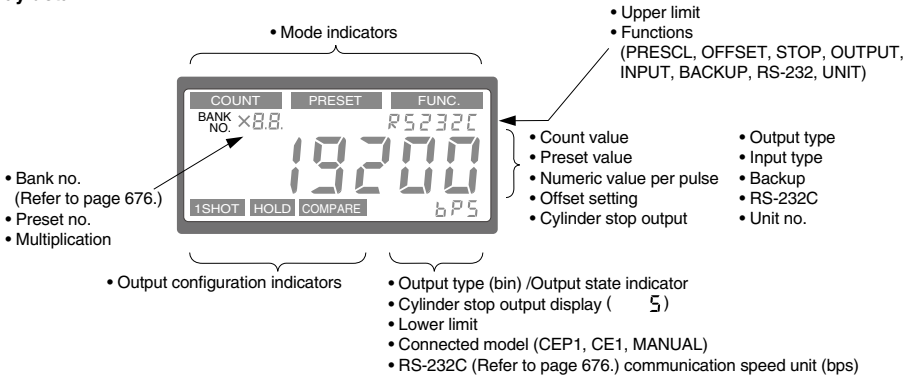

Key and Functions

Key	Functions
MODE	Changes the mode. In any given condition, it shifts to the next mode. Does not write data.
SEL.	Shifts the cursor to the next item. Does not write data.
SET	Writes displayed data into the memory when setting.
RIGHT	Shifts the cursor to the right when setting numerical values.
LEFT	Shifts the cursor to the left when setting numerical values.
UP	Changes the contents of a setting. Increases the value when setting numerical values.
DOWN	Changes the contents of a setting. Decreases the value when setting numerical values.

In the explanations of the operating method, references to "Direction keys" indicate the 4 keys RIGHT, LEFT, UP and DOWN.

Mode cycle using mode key

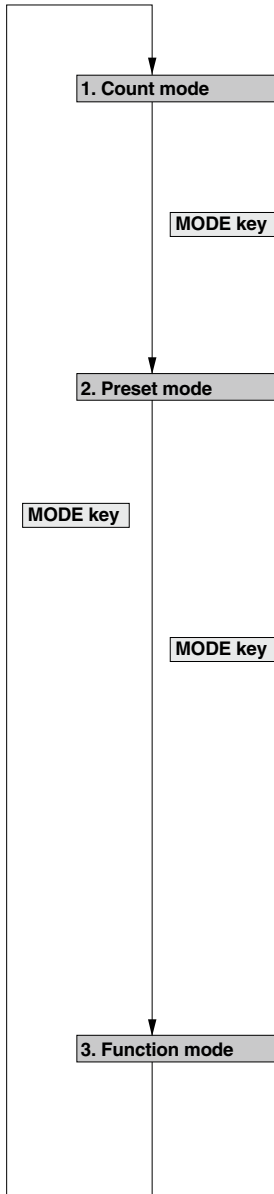

Basic Operation

- **SET key** : In any of the conditions (1) through (5), this writes the display data into the memory and shifts to (1).
- **SEL. key** : Shifts to the next item, but does not write data.
- **MODE key** : In any given condition, this shifts to the next mode, but does not write data.
- **Direction keys** : LEFT/RIGHT keys shift the digits, and UP/DOWN keys increase or decrease numerical values.

1. Explanation of display in count mode

Normal output display

Displays current output bank (Refer to page 676.)



Displays output state of each OUT terminal

Binary output display

Displays only when matched with preset

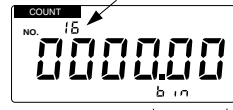

Display of binary output selection.

2. Setting of preset mode

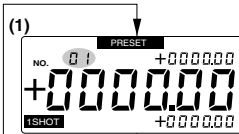

Selection of preset No.

- Select a preset number from 1 to 31 with the UP/DOWN keys.
- Shift to the next item with the SEL. key.

SEL. key



Setting the preset values

- Shift the digits with the LEFT/RIGHT keys, and increase or decrease the numerical values with the UP/DOWN keys.
- Shift to the next item with the SEL. key.

SEL. key



Setting the upper limit tolerance

- Set numerical values in the same way with the direction keys.
- When ± is selected, the lower limit display is cleared and ± setting is possible.
- Shift to the next item with the SEL. key.

SEL. key



Setting the lower limit tolerance

- Set numerical values in the same way with the direction keys.
- When ± is selected in the upper limit setting, this item is not displayed.
- Shift to the next item with the SEL. key.

SEL. key

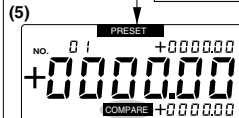

Setting the output configuration

- Switch to 1SHOT, HOLD or COMPARE with the UP/DOWN keys.
- Store the setting with the SET key.
- The SEL. key only shifts to another item without storing the setting.

SET. key

CEP1

CE1

CE2

ML2B

D-□

-X□

CEU5 Operation

3. Explanation of settings in the function mode

If the UP/DOWN keys are pressed when an item name is flashing, it shifts to another setting item. When the SEL. key is pressed, the cursor shifts and it is possible to change the content of the setting for the item which is being displayed.

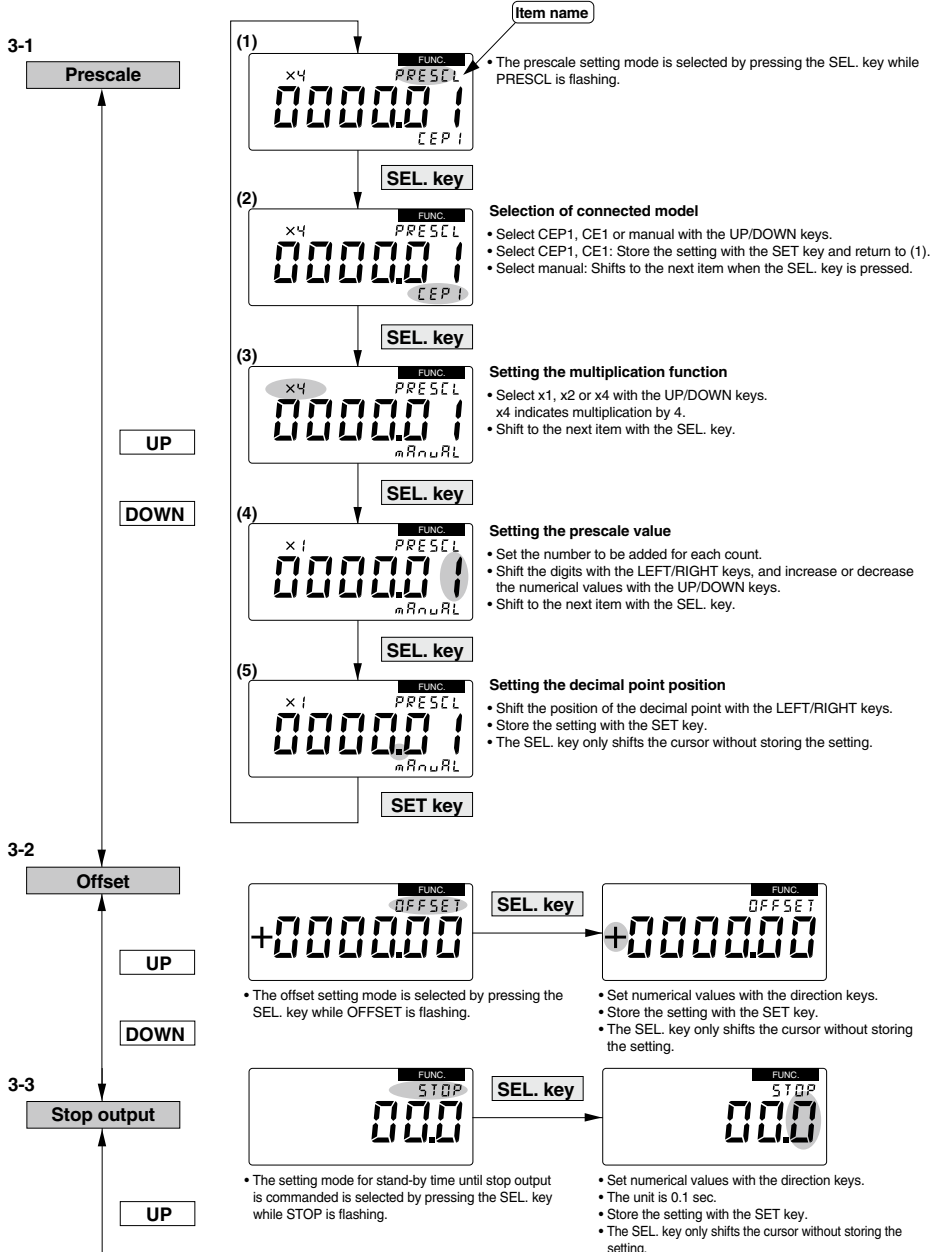

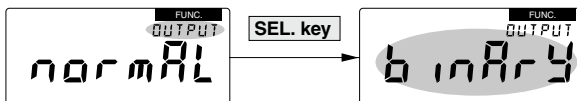
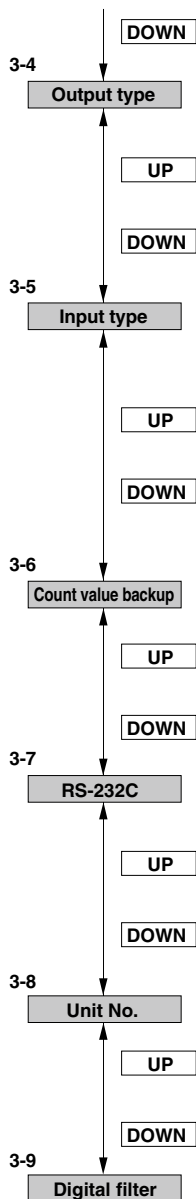

• The output system setting mode is selected by pressing the SEL. key while OUTPUT is flashing.

- Select normal output or binary output with the UP/DOWN keys.
- Store the setting with the SET key.
- The SEL. key only shifts the cursor without storing the setting.

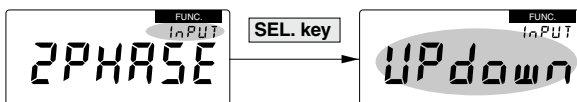

• The input type setting mode is selected by pressing the SEL. key while INPUT is flashing.

- Select phase difference input with the UP/DOWN keys, (\pm 2PHASE) or separate input (\pm UP/DOWN) with the UP/ DOWN keys.
- If the polarity changes, the count direction reverses.

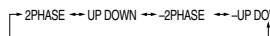

- Store the setting with the SET key.
- The SEL. key only shifts the cursor without storing the setting.

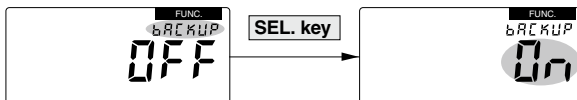

• The count value backup setting mode is selected by pressing the SEL. key while BACKUP is flashing.

- Select ON or OFF with the UP/DOWN keys.
- Store the setting with the SET key.
- The SEL. key only shifts the cursor without storing the setting.

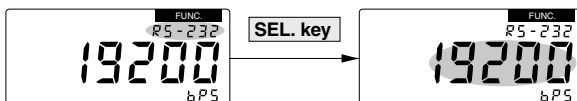

• The RS-232C (Refer to page 676.) communication speed setting mode is selected by pressing the SEL. key while RS-232 is flashing.

- Select the communication speed from 1200, 2400, 4800, 9600 or 19200 with the UP/DOWN keys.
- Store the setting with the SET key.
- The SEL. key only shifts the cursor without storing the setting.

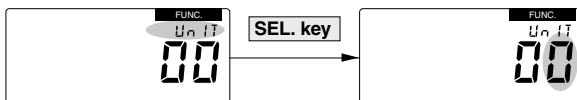

• The unit number registration mode is selected by pressing the SEL. key while UNIT is flashing.

- Set numerical values with the direction keys.
- Settings can be made from 00 to 99.
- Store the setting with the SET key.

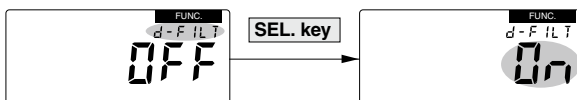

- Select ON or OFF with the UP/DOWN key.
- Store the setting with the SET key.

Note) When the digital filter setting (ON/OFF) is changed, an error count will occur. Reset the count value.

CEP1

CE1

CE2

ML2B

D-□

-X□

Glossary (Functions of CEU5)

BCD Output

This is a system which expresses one digit of a decimal number with a 4 digit binary number.
The count value is expressed by the ON/OFF state of each BCD output terminal. In the case of 6 digits, 24 terminals are required.

The relation between decimal numbers and BCD codes is shown in the table below.

Decimal no.	0	1	2	3	4	5	6	7	8	9
BCD	0000	0001	0010	0011	0100	0101	0110	0111	1000	1001

Ex.) 1294.53 is expressed as follows.
0001 0010 1001 0100 0101 0011

RS-232C

This is the interface standard for the serial transmission method, which is standard equipment on a personal computer.

Prescale Function

This function allows free setting of how many millimeters will indicate one pulse.

Binary Output

31 point preset output is possible without bank switching, by means of binary system output from a 5 point output terminal. Cylinder stop output is used as the readout release signal.

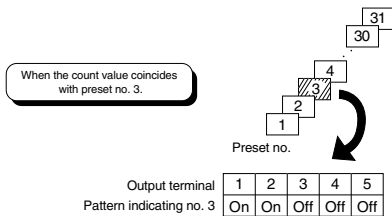

The coincident preset number is expressed as a 5 digit binary number.

Bank Function

5 points of preset output are possible simultaneously, however, a maximum of 20 types of work discrimination, etc. can be performed by using the 5 points of preset value as one of a maximum of four quadrats, and switching its use during operation.

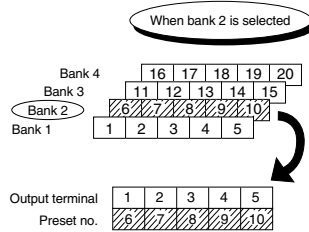

For example, when bank 2 is selected, presets 6 through 10 are valid and when the count value coincides with the setting value of 6 through 10, the respective output terminals 1 through 5 are turned ON.

Bank Switching Correspondence

Input terminal / Bank no.	BANK2	BANK1
1	OFF	OFF
2	OFF	ON
3	ON	OFF
4	ON	ON

Display Offset Function

Normally the count value returns to "0" after resetting, but with this function, the initial value can be set to any desired value.

Hold Function

When "hold" is input, the counter holds the current count value in memory. Next, when the count value is read into a PLC which uses serial or BCD output, etc., the count value that was held can be read in, even if there is a time lag.

Setting the Tolerances of Preset Values

The tolerance can be set as + \circ mm and - \blacktriangle mm. Additionally, the setting of + \circ mm and + \triangle mm, or - \bullet mm and - \blacktriangle mm is also possible. (However, $\circ > \triangle$ and $\blacktriangle > \bullet$ should be satisfied.)

By including preset tolerance setting, superior performance is exhibited in parts inspections, etc. In a workpiece to be measured, there are tolerances which assure a good product. For example, in the case of $10^{+0.05}_{-0.02}$, the CEU5 allows these tolerances to be input as they stand. If the workpiece is within tolerances the OK signal is sent.

<Simple input as per drawing dimensions> Tolerances can be set with the preset value. OK/NG signal is output by the counter. Labor savings can be realized in parts inspections.

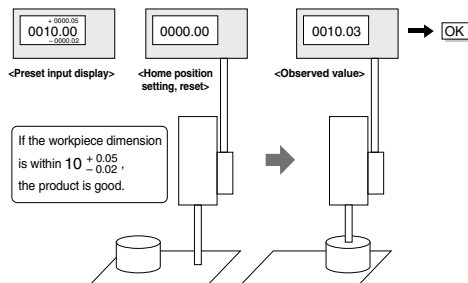

Count Value Protection

In the past, the count value returned to "0" when the power supply was cut off, but this function holds the previous value even after a power failure. This function can be switched between active and inactive settings.

Cylinder Stop Output

When workpiece discrimination is performed using a preset counter, it has been common to estimate the amount of time from the cylinder's start of operation until it touches the workpiece and stops, using a timer to read the output after a fixed amount of time. Since cylinder stop output is now output when there is no cylinder movement for a fixed amount of time, timing of preset output and external output, etc. is simplified.

CEP1

CE1

CE2

ML2B

D-□

-X□