

Compact Cylinder With Solenoid Valve

CVQ Series

ø32, ø40, ø50, ø63

Valve and compact cylinder integrated for compactness **CE**

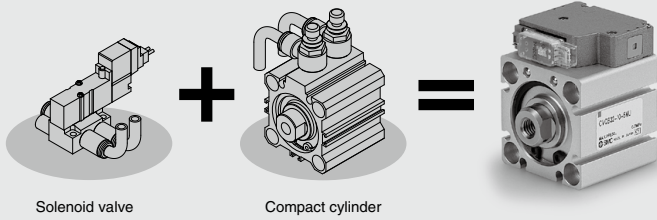

Solenoid valve

Compact cylinder

● Labor saving

- No need to select size of valve
- Less piping work

● Energy saving

- Air consumption between the valve and cylinder reduced by approximately 50%.

● Space saving

- Small mounting space with valve integrated structure

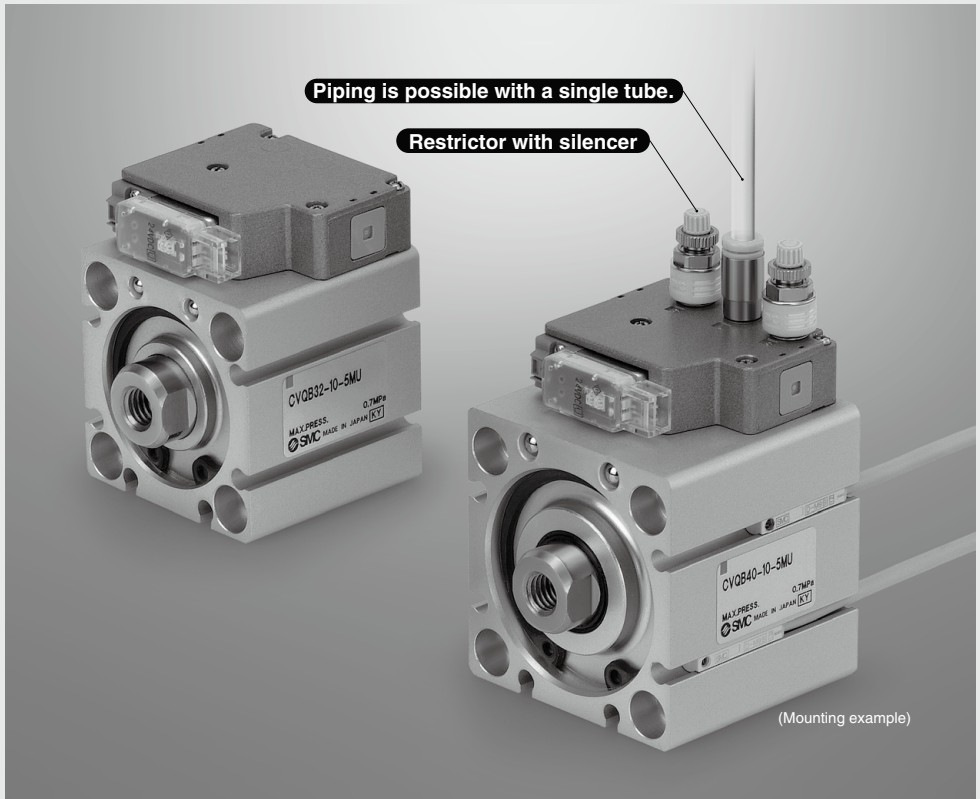

CVQ

CVQM

CVJ

CVM

CV3

CVS1

MVGQ

D-

-X

Easy Mounting

Height Comparison (Dimensional difference: C)

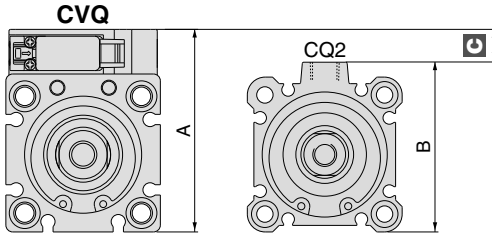

Bore size	A	B	C (mm)
32	59	49.5	9.5
40	67	57	10
50	83	71	12
63	97	84	13

Mounting Example

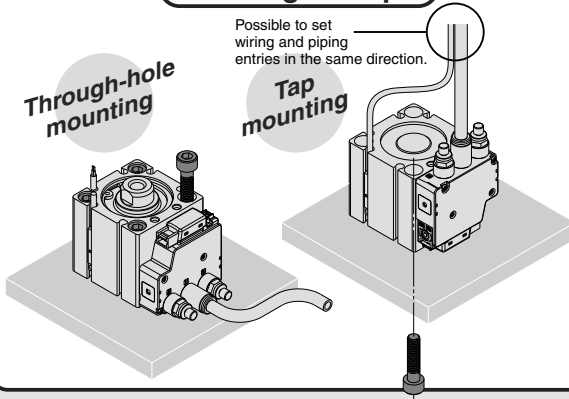

Selectable Piping Direction

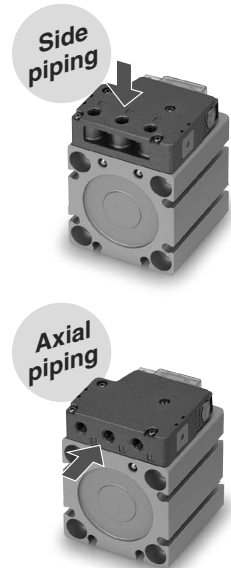

Low Air Consumption

Approx. **50%** reduction in air consumption by reducing the piping between the valve and cylinder

- Cylinder bore size: $\phi 32$ mm
- Cylinder stroke: 30 mm
- Piping: I.D. $\phi 4$ mm
- Length 2 m

Variation

Bore size (mm)	Standard stroke (mm)											
	5	10	15	20	25	30	35	40	45	50	75	100
32	●	●	●	●	●	●	●	●	●	●	●	●
40	●	●	●	●	●	●	●	●	●	●	●	●
50	—	●	●	●	●	●	●	●	●	●	●	●
63	—	●	●	●	●	●	●	●	●	●	●	●

Compact Cylinder With Solenoid Valve

CVQ Series

ø32, ø40, ø50, ø63



How to Order

CVQ **B** **32** - **30** - **M9BW** - **5** **M**

Mounting

B	Through-hole, Both ends tapped (Standard)
L	Foot
F	Rod flange
G	Head flange
D	Double clevis

* Mounting brackets are included, (but not assembled).

Bore size

32	32 mm
40	40 mm
50	50 mm
63	63 mm

Cylinder stroke (mm)

Please refer to page 728 for "Standard Stroke" and "Intermediate Stroke".

Body option

Nil	Standard (Rod end female thread)
F	With boss in head end
M	Rod end male thread

The combination of body options is available.
Example) FM

Auto switch

Nil	Without auto switch (Built-in magnet)
------------	---------------------------------------

* For applicable auto switch models, refer to the below table.

Number of auto switches

Nil	2 pcs.
S	1 pc.
N	"n" pcs.

Rated voltage

5	24 VDC
6	12 VDC

Port thread type

Nil	M5 x 0.8	ø32
	Rc	ø40
F	G	ø50
	NPT	ø63

Piping

Nil	Standard
P	Axial

Standard piping

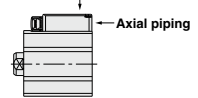

Manual override

Nil	Non-locking push type
B	Locking slotted type

Surge voltage suppressor

Nil	Without surge voltage suppressor
S	With surge voltage suppressor
Z	With light/surge voltage suppressor
R	With surge voltage suppressor (Non-polar type)
U	With light/surge voltage suppressor (Non-polar type)

Electrical entry

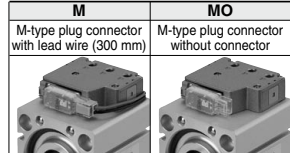

* For lead wire lengths other than 300 mm, refer to the plug connector lead wire (page 731).

Applicable Auto Switches / Refer to pages 941 to 1067 for detailed auto switch specifications.

Type	Special function	Electrical entry	Indicator light	Wiring (Output)	Load voltage		Auto switch model		Lead wire length(m)*				Pre-wired connector	Applicable load	
					DC	AC	Electrical entry		0.5 (Nil)	1 (M)	3 (L)	5 (Z)			
							Perpendicular	In-line							
Solid state auto switch	Diagnostic indication (2-color indicator) Water resistant (2-color indicator)	Grommet	Yes	3-wire (NPN)	5 V, 12 V	—	M9NV	M9N	●	●	●	○	IC circuit	Relay, PLC	
				3-wire (PNP)					●	●	●	○			
				2-wire	12 V	—	M9BV	M9B	●	●	●	○			—
				3-wire (NPN)	5 V, 12 V	—	M9NVW	M9NW	●	●	●	○			IC circuit
				3-wire (PNP)			M9PVW	M9PW	●	●	●	○			
				2-wire	12 V	—	M9BWW	M9BW	●	●	●	○			—
				3-wire (NPN)	5 V, 12 V	—	M9NAV ^{*1}	M9NA ^{*1}	○	○	○	○			IC circuit
				3-wire (PNP)			M9PAV ^{*1}	M9PA ^{*1}	○	○	●	○			
				2-wire	12 V	—	M9BAV ^{*1}	M9BA ^{*1}	○	○	○	○			—
				Reed auto switch	Grommet	Yes	3-wire (NPN equivalent)	—	5 V	—	A96V	A96			●
2-wire	24 V	12 V	100 V				A93V ^{*2}	A93	●	●	●	—	—	Relay, PLC	
—	5 V, 12 V	100 V or less	A90V				A90	●	—	—	—	IC circuit	—		

*1 Water resistant type auto switches can be mounted on the above models, but in such case SMC cannot guarantee water resistance. Consult with SMC regarding water resistant types with the above model numbers.

*2 1 m type lead wire is only applicable to D-A93.

* Lead wire length symbols: 0.5 m Nil (Example) M9NW
 1 m M M9NWM
 3 m L M9NLW
 5 m Z M9NZW

* Solid state auto switches marked with "○" are produced upon receipt of order.
 * For details about auto switches with pre-wired connector, refer to pages 1014 and 1015.
 * Auto switches are shipped together (not assembled).

CVQ

CVQM

CVJ

CVM

CV3

CVS1

MVGQ

D-

X-

CVQ Series



⚠ Caution

Do not separate the cylinder from the valve.

Symbol

With valve (Rubber bumper)

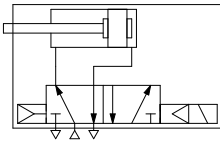

Theoretical Output

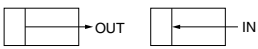

Unit: N

Bore size (mm)	Operating direction	Operating pressure (MPa)		
		0.3	0.5	0.7
32	IN	181	302	422
	OUT	241	402	563
40	IN	317	528	739
	OUT	377	628	880
50	IN	495	825	1150
	OUT	589	982	1370
63	IN	840	1400	1960
	OUT	936	1560	2184

Mounting Bracket Part No.

Bore size (mm)	Foot (Note)	Flange	Double clevis
32	CVQ-L032	CVQ-F032	CVQ-D032
40	CVQ-L040	CVQ-F040	CVQ-D040
50	CQ-L050	CQ-F050	CVQ-D050
63	CVQ-L063	CVQ-F063	CVQ-D063

Note) Order two foot brackets per cylinder.

* Parts belonging to each bracket are as follows.

Foot, Flange: Body mounting screws

Double clevis: Clevis pin, C-type retaining ring for shaft, Body mounting screws

Accessory bracket

For details about the single knuckle joint, double knuckle joint, knuckle pin, rod end nut, and simple joint, refer to page 735.

728

Cylinder Specifications

Bore size (mm)	32	40	50	63
Action	Double acting, single rod			
Fluid	Air (Non-lube)			
Proof pressure	1.0 MPa			
Maximum operating pressure	0.7 MPa			
Minimum operating pressure	0.15 MPa			
Ambient and fluid temperature	-10 to 50°C (No freezing)			
Stroke tolerance	0 to +1.0 mm*			
Mounting method	Through-hole / Both ends tapped			
Piston speed	50 to 500 mm/s			
Cushion	Rubber bumper			

* Stroke length tolerance does not include variations in the bumper value.

Valve Specifications

Type of actuation	2 position single
Manual override	Non-locking push type / Locking slotted type
Pilot exhaust	Main/Pilot valve common exhaust type
Mounting orientation	Unrestricted (based on cylinder mounting orientation)
Enclosure	Dustproof

Solenoid Specifications

Electrical entry		M-type plug connector
Coil rated voltage	DC	24/12 (V)
Allowable voltage fluctuation (Note)		±10% of the rated voltage
Power consumption	DC	0.35 (With light: 0.4) W
Surge voltage suppressor		Diode (Non-polar type: Varistor)
Indicator light		LED

Note) The S and Z types of surge voltage suppressor have an internal circuit allowing voltage drop, so use within the following allowable voltage fluctuation range.

S, Z type 24 VDC: -7% to +10%
12 VDC: -4% to +10%

Standard Stroke

Bore size (mm)	Standard stroke (mm)
32 ^{*1}	5, 10, 15, 20, 25, 30, 35, 40, 45, 50, 75, 100
40	5, 10, 15, 20, 25, 30, 35, 40, 45, 50, 75, 100
50 ^{*2}	10, 15, 20, 25, 30, 35, 40, 45, 50, 75, 100
63	10, 15, 20, 25, 30, 35, 40, 45, 50, 75, 100

*1 The outline dimensions for 5 mm stroke will be the same as those for 10 mm stroke.

*2 The outline dimensions for 10 mm stroke will be the same as those for 15 mm stroke.

Intermediate Stroke

Part no.	Refer to "How to Order" for standard model numbers (previous page). Intermediate strokes are available by using spacers with standard stroke cylinders.	
Description	Bore size	Description
	32	Compatible with strokes of 1 mm increments.
Stroke range (mm)	40, 50, 63	Compatible with strokes of 5 mm increments.
	Bore size	Stroke range
Applicable example	32	1 to 99
	40, 50, 63	5 to 95
Part no.: CVQB32-95-□ A spacer of 5 mm is installed in standard cylinder CVQB32-100-□. B dimension is 133 mm.		

Weight

Weights

Bore size (mm)	Stroke												Unit (g)
	5	10	15	20	25	30	35	40	45	50	75	100	
32	295	288	310	332	354	376	398	420	442	464	575	686	
40	365	391	417	443	469	495	521	547	573	599	726	853	
50	—	735	721	760	800	839	879	918	958	997	1195	1392	
63	—	863	905	947	990	1032	1074	1116	1158	1200	1411	1621	

Calculation: (Example) **CVQB32-20M**

- Basic weight: CVQB32-20..... 332 g
 - Additional weight: Rod end male thread..... 43 g
- 375 g

Additional Weight

Bore size (mm)		32	40	50	63
Axial piping		5	5	4	4
Connector (300 mm)		3	3	3	3
Rod end male thread	Male thread	26	27	53	53
	Nut	17	17	32	32
With boss in head end		5	7	13	25
Foot (including mounting bolt)		148	160	243	334
Rod flange (including mounting bolt)		185	219	373	569
Head flange (including mounting bolt)		170	203	348	544
Double clevis (including pin, retaining ring, bolt)		156	201	399	574

Mounting Bolt for CVQ

Mounting: Be sure to use it as through-hole when mounting.

Refer to the following for ordering procedures.
Order the actual number of bolts that will be used.

Example) CQ- M5 x 45L: 4 pcs.

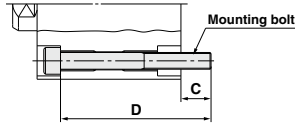

Cylinder model	C	D	Mounting bolt size
CVQB32- 5	9	45	CQ- M5 x 45L
- 10		45	x 45L
- 15		50	x 50L
- 20		55	x 55L
- 25		60	x 60L
- 30		65	x 65L
- 35		70	x 70L
- 40		75	x 75L
- 45		80	x 80L
- 50		85	x 85L
- 75		110	x 110L
-100	135	x 135L	
CVQB40- 5	7.5	45	CQ- M5 x 45L
- 10		50	x 50L
- 15		55	x 55L
- 20		60	x 60L
- 25		65	x 65L
- 30		70	x 70L
- 35		75	x 75L
- 40		80	x 80L
- 45		85	x 85L
- 50		90	x 90L
- 75		115	x 115L
-100		140	x 140L

Cylinder model	C	D	Mounting bolt size
CVQB50- 10	12.5	60	CQ- M6 x 60L
- 15		60	x 60L
- 20		65	x 65L
- 25		70	x 70L
- 30		75	x 75L
- 35		80	x 80L
- 40		85	x 85L
- 45		90	x 90L
- 50		95	x 95L
- 75		120	x 120L
-100	145	x 145L	
CVQB63- 10	14.5	60	CQ- M8 x 60L
- 15		65	x 65L
- 20		70	x 70L
- 25		75	x 75L
- 30		80	x 80L
- 35		85	x 85L
- 40		90	x 90L
- 45		95	x 95L
- 50		100	x 100L
- 75		125	x 125L
-100		150	x 150L

CVQ

CVQM

CVJ

CVM

CV3

CVS1

MVGQ

D-

-X

Allowable Kinetic Energy

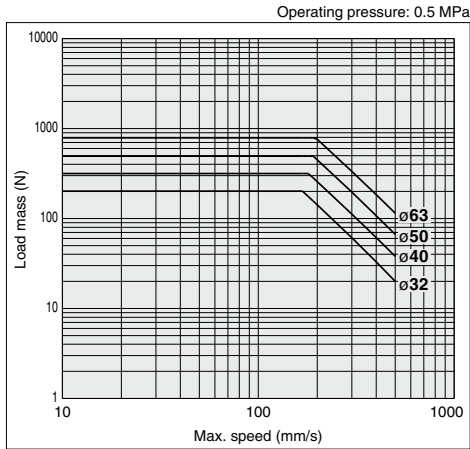

Rod End Allowable Lateral Load

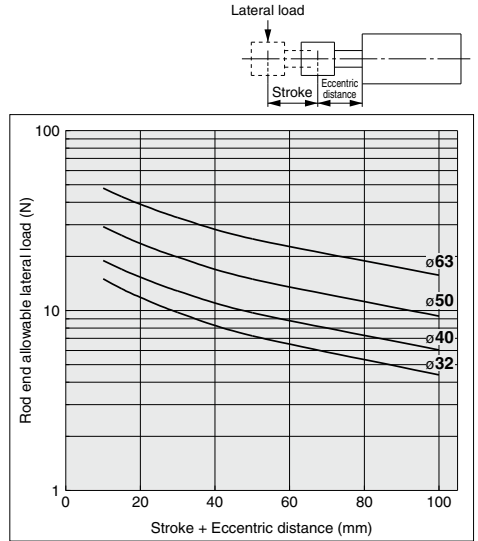

The allowable lateral load applied to the rod end is as shown above. Do not use exceeding the value shown by the graph.

Relationship between Number of Needle Rotations and Piston Speed

$\phi 32, \phi 40$

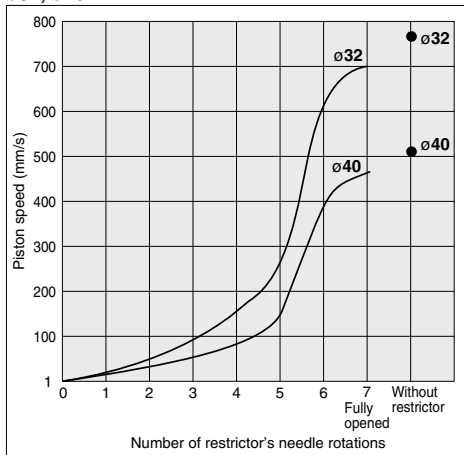

Restrictor: ASN2-M5
 Pressure: 0.5 MPa
 Mounting orientation: Horizontal, with no load, piston extended
 * The above piston speed is for reference purpose only.

$\phi 50, \phi 63$

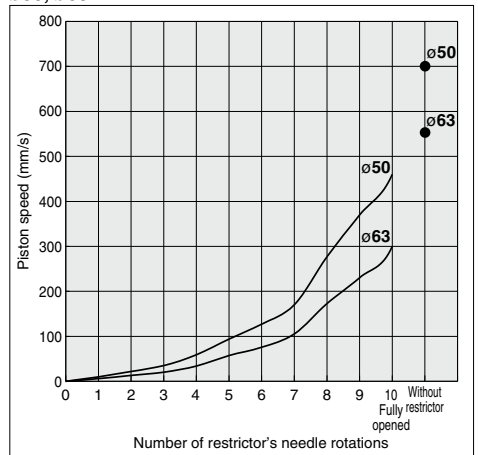

Restrictor: ASN2-01
 Pressure: 0.5 MPa
 Mounting orientation: Horizontal, with no load, piston extended
 * The above piston speed is for reference purpose only.

<Exhaust restrictor with silencer >



Applicable bore size (mm)	Model	Port size	Effective area (mm ²)	Weight (g)
32, 40	ASN2-M5	M5 x 0.8	1.8	5
50, 63	ASN2-01	1/8	3.6	17

Construction

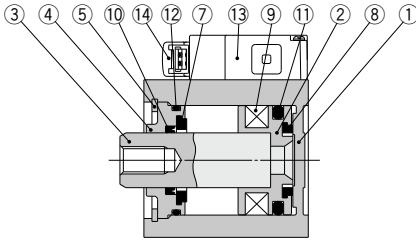

Basic Type

Component Parts

No.	Description	Material	Note
1	Cylinder tube	Aluminum alloy	Hard anodized
2	Piston	Aluminum alloy	
3	Piston rod	Carbon steel	Hard chrome plated
4	Collar	Aluminum alloy casting	ø50, ø63, chromate coating
		Aluminum alloy	Anodized
5	Retaining ring	Carbon tool steel	Phosphate coated
6	Bushing	Bearing alloy	ø50, ø63
7	Bumper A	Urethane	
8	Bumper B	Urethane	
9	Magnet	—	
10	Rod seal	NBR	
11	Piston seal	NBR	
12	Gasket	NBR	
13	Solenoid valve	—	
14	Pilot valve	—	
15	Boss ring	Aluminum alloy	Hard anodized
16	Rod end nut	Carbon steel	Nickel plated

Replacement parts: Seal Kit

Bore size	Order no.	Contents
32	CQ2B32-PS	Set of nos. above ⑩⑪⑫
40	CQ2B40-PS	
50	CQ2B50-PS	
63	CQ2B63-PS	

* Seal kit includes ⑩, ⑪, ⑫. Order the seal kit, based on each bore size.
* Grease pack must be ordered separately as it is not included in the seal kit.

Grease part no.: GR-S-010 (10 g)

How to Order Pilot Valve Assembly

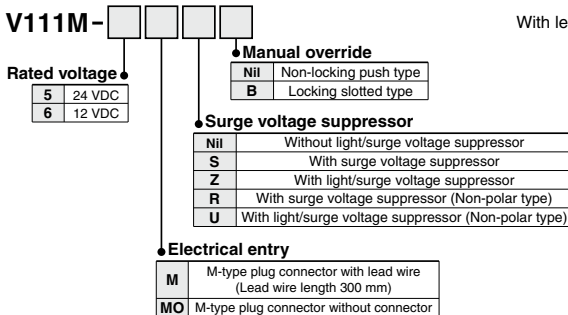

With boss in head end

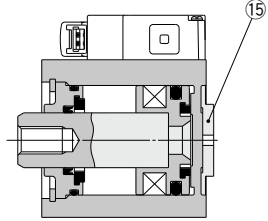

ø50, ø63

Rod end male thread

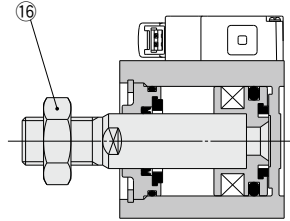

Manual button

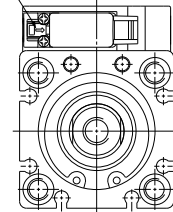

Length of plug connector lead wire

The standard length of the plug connector with a lead wire is 300 mm, but other lengths are available as follows.

How to Order Connector Assembly

With lead wire: SY100-30-4A-□

Lead wire length ●			
Nil	300 mm	20	2000 mm
6	600 mm	25	2500 mm
10	1000 mm	30	3000 mm
15	1500 mm	50	5000 mm

How to Order

Indicate the part number of the connector assembly in addition to the part number of the solenoid valve without the connector for the plug connector.
Example) Lead wire length 2000 mm

When ordering cylinder with valve
CQQB32-30-M9B-5MOZ
SY100-30-4A-20

CVQ

CVQM

CVQ□

CVM□

CV3

CVS1

MVGQ

D-□

-X□

CVQ Series

Dimensions: $\varnothing 32$, $\varnothing 40$, $\varnothing 50$, $\varnothing 63$

Basic: CVQB

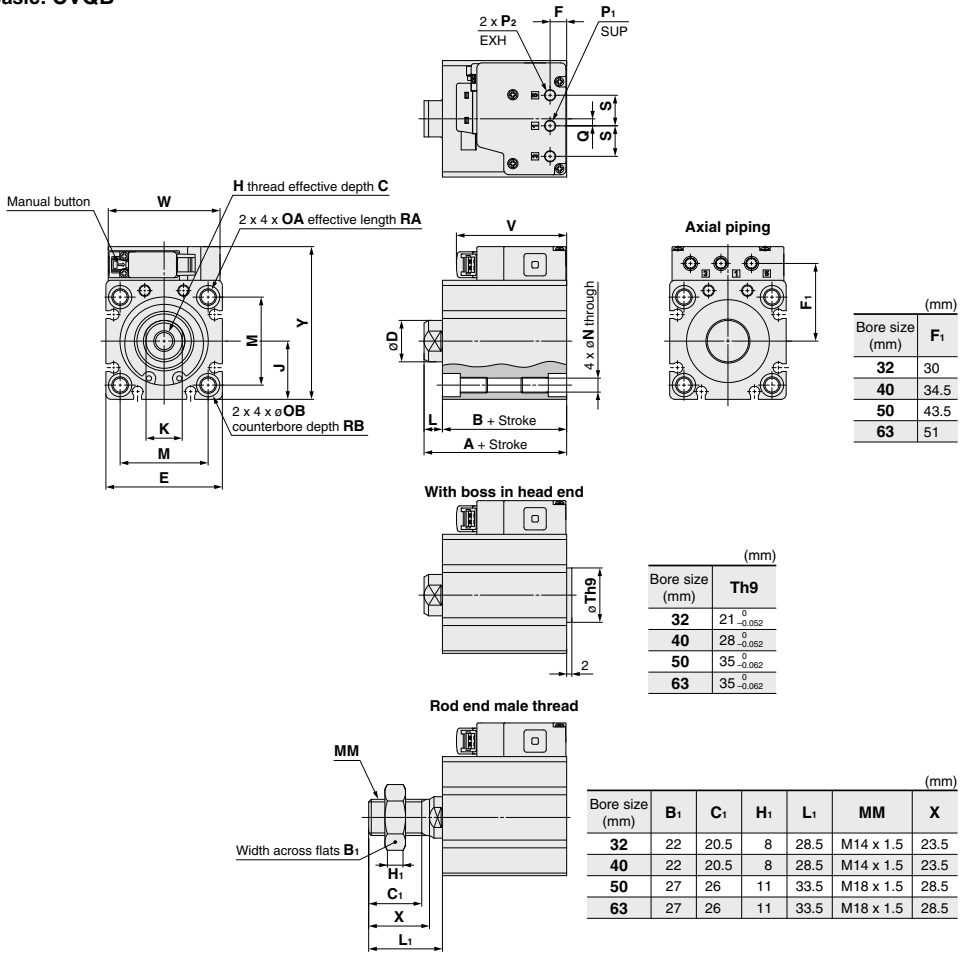

		(mm)																
Bore size (mm)	Stroke range (mm)	A	B	C	D	E	F	H	J	K	L	M	N	OA	OB	P ₁	P ₂	Q
32	5 to 100	40 ^{Note 1)}	33 ^{Note 1)}	13	16	45	6.5	M8 x 1.25	22.5	14	7	34	5.4	M6 x 1	9	M5 x 0.8	M5 x 0.8	2.5
40	5 to 100	46.5	39.5	13	16	52	6.5	M8 x 1.25	26	14	7	40	5.4	M6 x 1	9	M5 x 0.8	M5 x 0.8	2.5
50	10 to 100	48.5 ^{Note 2)}	40.5 ^{Note 2)}	15	20	64	7.5	M10 x 1.5	32	17	8	50	6.6	M8 x 1.25	11	Rc, G, NPT1/8	Rc, G, NPT1/8	3.5
63	10 to 100	54	46	15	20	77	7.5	M10 x 1.5	38.5	17	8	60	9	M10 x 1.5	14	Rc, G, NPT1/8	Rc, G, NPT1/8	3.5

Bore size (mm)	Stroke range (mm)	RA	RB	S	V	W	Y
32	5 to 100	10	7	12	43	43.5	59
40	5 to 100	10	7	12	43	43.5	67
50	10 to 100	14	8	17	54	63	83
63	10 to 100	18	10.5	17	54	63	97

Note 1) The dimensions (A + stroke) and (B + stroke) for 5 mm stroke will be the same as those for 10 mm stroke.
 Note 2) The dimensions (A + stroke) and (B + stroke) for 10 mm stroke will be the same as those for 15 mm stroke.

Dimensions: $\varnothing 32$, $\varnothing 40$, $\varnothing 50$, $\varnothing 63$

Foot: CVQL

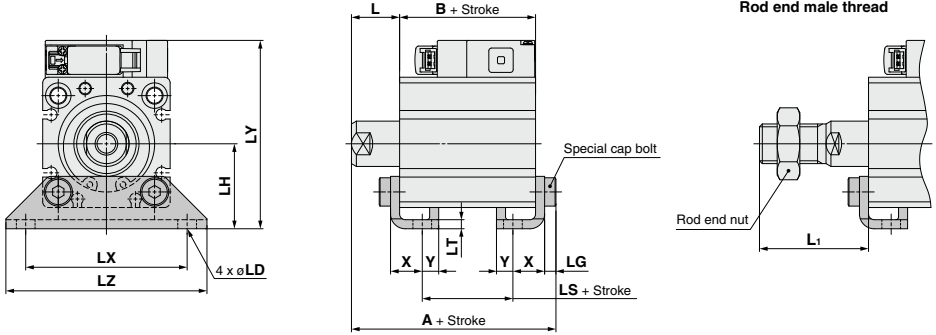

															(mm)				
Bore size (mm)	Stroke range (mm)	A	B	LS	L	L ₁	LD	LG	LH	LT	LX	LY	LZ	X	Y	Foot bracket material: Carbon steel Surface treatment: Nickel plated			
32	5 to 100	57.2 ^{Note 1)}	33 ^{Note 2)}	17 ^{Note 1)}	17	38.5	6.6	4	30	3.2	57	66.5	71	11.2	5.8				
40	5 to 100	63.7	39.5	23.5	17	38.5	6.6	4	33	3.2	64	74	78	11.2	7				
50	10 to 100	66.7 ^{Note 2)}	40.5 ^{Note 2)}	17.5 ^{Note 2)}	18	43.5	9	5	39	3.2	79	90	95	14.7	8				
63	10 to 100	72.2	46	20	18	43.5	11	5	46	3.2	95	104.5	113	16.2	9				

Note 1) The dimensions (A + stroke), (B + stroke) and (LS + stroke) for 5 mm stroke will be the same as those for 10 mm stroke.
 Note 2) The dimensions (A + stroke), (B + stroke) and (LS + stroke) for 10 mm stroke will be the same as those for 15 mm stroke.

Rod flange: CVQF

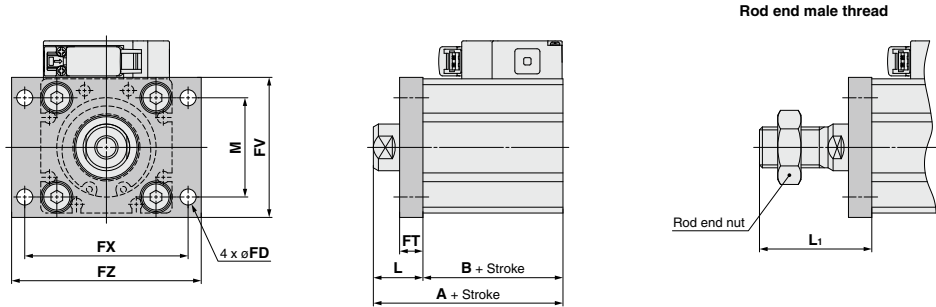

													(mm)		
Bore size (mm)	Stroke range (mm)	A	B	FD	FT	FV	FX	FZ	L	L ₁	M	Flange bracket material: Carbon steel Surface treatment: Nickel plated			
32	5 to 100	50 ^{Note 1)}	33 ^{Note 1)}	5.5	8	48	56	65	17	38.5	34				
40	5 to 100	56.5	39.5	5.5	8	54	62	72	17	38.5	40				
50	10 to 100	58.5 ^{Note 2)}	40.5 ^{Note 2)}	6.6	9	67	76	89	18	43.5	50				
63	10 to 100	64	46	9	9	80	92	108	18	43.5	60				

Note 1) The dimensions (A + stroke) and (B + stroke) for 5 mm stroke will be the same as those for 10 mm stroke.
 Note 2) The dimensions (A + stroke) and (B + stroke) for 10 mm stroke will be the same as those for 15 mm stroke.

- CVQ**
- CVQM
- CVJ
- CVM
- CV3**
- CVS1
- MVGQ

- D-**
- X**

CVQ Series

Dimensions: $\varnothing 32$, $\varnothing 40$, $\varnothing 50$, $\varnothing 63$

Head flange: CVQG

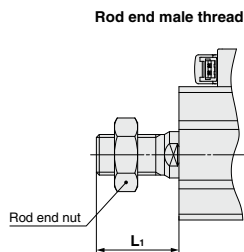
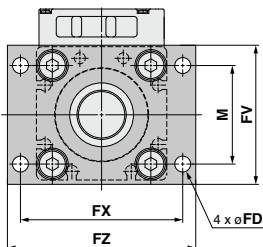
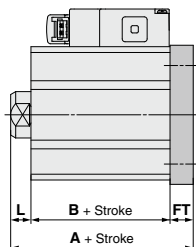

Bore size (mm)	Stroke range (mm)	A	B	FD	FT	FV	FX	FZ	L	L ₁	M
32	5 to 100	48 <small>Note 1)</small>	33 <small>Note 1)</small>	5.5	8	48	56	65	7	28.5	34
40	5 to 100	54.5	39.5	5.5	8	54	62	72	7	28.5	40
50	10 to 100	57.5 <small>Note 2)</small>	40.5 <small>Note 2)</small>	6.6	9	67	76	89	8	33.5	50
63	10 to 100	63	46	9	9	80	92	108	8	33.5	60

Flange bracket material: Carbon steel
Surface treatment: Nickel plated

Note 1) The dimensions (A + stroke) and (B + stroke) for 5 mm stroke will be the same as those for 10 mm stroke.
Note 2) The dimensions (A + stroke) and (B + stroke) for 10 mm stroke will be the same as those for 15 mm stroke.

Double clevis: CVQD

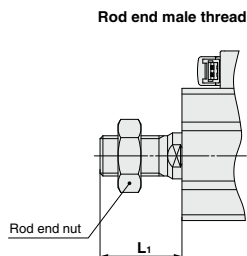
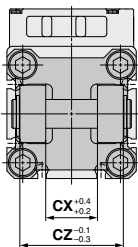
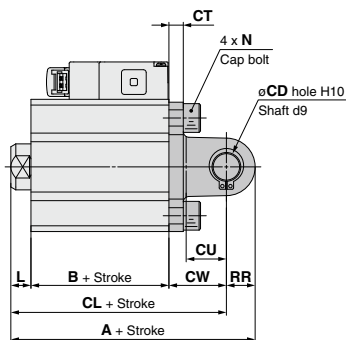

Bore size (mm)	Stroke range (mm)	A	B	CL	CD	CT	CU	CW	CX	CZ	L	L ₁	N	RR
32	5 to 100	70 <small>Note 1)</small>	33 <small>Note 1)</small>	60	10	5	14	20	18	36	7	28.5	M6 x 1	10
40	5 to 100	78.5	39.5	68.5	10	6	14	22	18	36	7	28.5	M6 x 1	10
50	10 to 100	90.5 <small>Note 2)</small>	40.5 <small>Note 2)</small>	76.5	14	7	20	28	22	44	8	33.5	M8 x 1.25	14
63	10 to 100	98	46	84	14	8	20	30	22	44	8	33.5	M10 x 1.5	14

Double clevis bracket material: Cast iron
Surface treatment: Coated

Note 1) The dimensions (A + stroke), (B + stroke) and (CL + stroke) for 5 mm stroke will be the same as those for 10 mm stroke.
Note 2) The dimensions (A + stroke), (B + stroke) and (CL + stroke) for 10 mm stroke will be the same as those for 15 mm stroke.

Accessory Bracket

Single knuckle joint

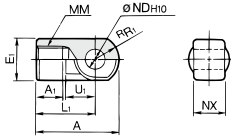

Material: Cast iron (mm)

Part no.	Applicable bore size (mm)	A	A ₁	E ₁	L ₁	MM	^R R ₁	U ₁	NDH10	NX
I-G04	32, 40	42	14	ø22	30	M14 x 1.5	12	14	10 ^{+0.058}	18 ^{+0.3}
I-G05	50, 63	56	18	ø28	40	M18 x 1.5	16	20	14 ^{+0.070}	22 ^{+0.3}

Knuckle pin (Common with double clevis pin)

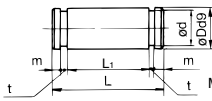

Material: Carbon steel (mm)

Part no.	Applicable bore size (mm)	Dd9	L	d	L ₁	m	t	Retaining ring
IY-G04	32, 40	10 ^{+0.040} 10 ^{-0.076}	41.6	9.6	36.2	1.55	1.15	10 C-type for shaft
IY-G05	50, 63	14 ^{+0.052} 14 ^{-0.090}	50.6	13.4	44.2	2.05	1.15	14 C-type for shaft

Simple Joint / ø32 to ø63

Joint and mounting bracket (A/B-type) part no.

YA - 03

● Mounting bracket

● Applicable air cylinder bore size

YA	A-type mounting bracket
YB	B-type mounting bracket
YU	Joint

03	For ø32, ø40
05	For ø50, ø63



Allowable Eccentricity (mm)

Bore size	ø32	ø40	ø50	ø63
Eccentricity tolerance	±1			
Backlash	0.5			

<Ordering>

- Joints are not included with the A- or B-type mounting brackets. Order them separately.

(Example)

Bore size for ø40 Order number

A-type mounting bracket part number YA-03

• Joint YU-03

Joint and mounting bracket (A/B-type) part no.

Bore size (mm)	Joint part no.	Applicable mounting bracket	
		A-type mounting bracket	B-type mounting bracket
32, 40	YU-03	YA-03	YB-03
50, 63	YU-05	YA-05	YB-05

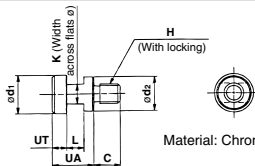

Material: Chromium molybdenum steel (Nickel plated) (mm)

Part no.	Applicable bore size (mm)	UA	C	d ₁	d ₂	H	K	L	UT	Weight (g)
YU-03	32, 40	17	11	15.8	14	M8 x 1.25	8	7	6	25
YU-05	50, 60	17	13	19.8	18	M10 x 1.5	10	7	6	40

Double knuckle joint

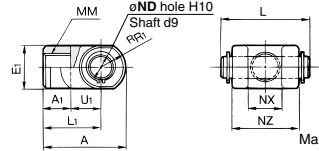

Material: Cast iron (mm)

Part no.	Applicable bore size (mm)	A	A ₁	E ₁	L ₁	MM	^R R ₁	U ₁	NDH10	NX	NZ	L	Applicable pin part no.
Y-G04	32, 40	42	16	ø22	30	M14 x 1.5	12	14	10 ^{+0.058}	18 ^{+0.3}	36	41.6	IY-G04
Y-G05	50, 63	56	20	ø28	40	M18 x 1.5	16	20	14 ^{+0.070}	22 ^{+0.3}	44	50.6	IY-G05

* Knuckle pin and retaining ring are included.

Rod end nut

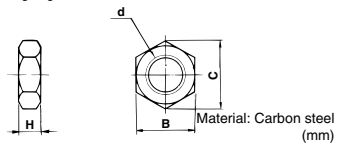

Material: Carbon steel (mm)

Part no.	Applicable bore size (mm)	d	H	B	C
NT-04	32, 40	M14 x 1.5	8	22	25.4
NT-05	50, 63	M18 x 1.5	11	27	31.2

A-type mounting bracket

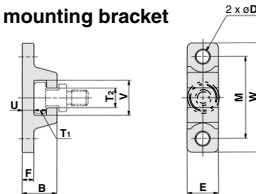

Material: Chromium molybdenum steel (Nickel plated) (mm)

Part no.	Bore size (mm)	B	D	E	F	M	T ₁	T ₂
YA-03	32, 40	18	6.8	16	6	42	6.5	10
YA-05	50, 63	20	9	20	8	50	6.5	12

Part no.	Bore size (mm)	U	V	W	Weight (g)
YA-03	32, 40	6	18	56	55
YA-05	50, 63	8	22	67	100

B-type mounting bracket

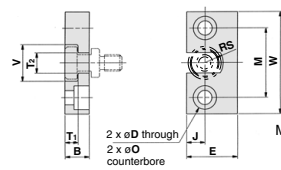

Material: Carbon steel (Nickel plated) (mm)

Part no.	Bore size (mm)	B	D	E	J	M	øO
YB-03	32, 40	12	7	25	9	34	11.5 depth 7.5
YB-05	50, 63	12	9	32	11	42	14.5 depth 8.5

Part no.	Bore size (mm)	T ₁	T ₂	V	W	RS	Weight (g)
YB-03	32, 40	6.5	10	18	50	9	80
YB-05	50, 63	6.5	12	22	60	11	120

CVQ

CVQM

CVJ

CVM

CV3

CVS1

MVGQ

D-

X-

Auto Switch Mounting

Auto Switch Proper Mounting Position (Detection at Stroke End) and Its Mounting Height

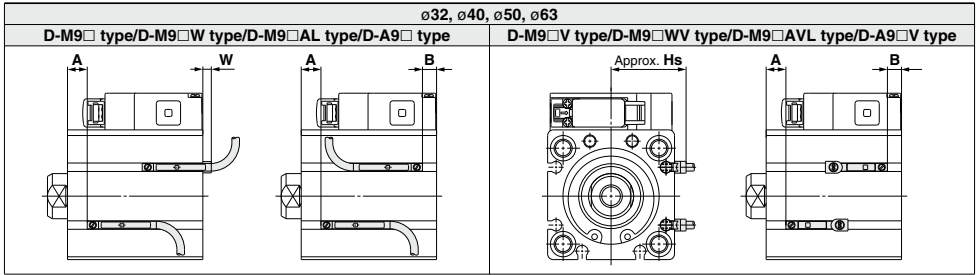

(mm)

Bore size (mm)	D-M9□ D-M9□W			D-M9□V, D-M9□WV D-M9□AV			D-M9□A			D-A9□			D-A9□V		
	A	B	W	A	B	Hs	A	B	W	A	B	W	A	B	Hs
32	12 [17]	9	1	12 [17]	9	29	12 [17]	9	3	8 [13]	5	-3 (-0.5)	8 [13]	5	27
40	16	11.5	-1.5	16	11.5	32.5	16	11.5	0.5	12	7.5	-5.5 (-3)	12	7.5	30.5
50	14 <19>	14.5	-4.5	14 <19>	14.5	38.5	14 <19>	14.5	-2.5	10 <15>	10.5	-8.5 (-6)	10 <15>	10.5	36.5
63	16.5	17.5	-7.5	16.5	17.5	42	16.5	17.5	-5.5	12.5	13.5	-11.5 (-9)	12.5	13.5	40

The value in parentheses [] is for 5 mm stroke with $\phi 32$.
The value in parentheses < > is for 10 mm stroke with $\phi 50$.

() : Denotes the values for D-A9□.

* The negative indication in the table for W shows the mounting inside the cylinder body.

* For the actual setting, check the operating condition of the auto switch and adjust.

Auto Switch Mountable Surface, Mounting Groove Number (Direct Mounting)

The below table shows which surfaces of the cylinder an auto switch can be mounted on, and the number of slots for the direct mounting type auto switch.

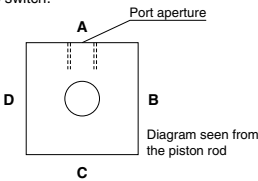

Switch model	D-M9□(V), M9□W(V), M9□A(V), A9□(V)			
	A (Mounting groove number)	B (Mounting groove number)	C (Mounting groove number)	D (Mounting groove number)
Bore size (mm)				
32	—	○ (2)	○ (2)	○ (2)
40	—	○ (2)	○ (2)	○ (2)
50	—	○ (2)	○ (2)	○ (2)
63	—	○ (2)	○ (2)	○ (2)

Operating Range

Auto switch model	Bore size (mm)			
	32	40	50	63
D-M9□, D-M9□V D-M9□W, D-M9□WV D-M9□A, D-M9□AV	6	6	7	7.5
D-A9□, D-A9□V	9.5	9.5	9.5	11.5

* Since this is a guideline including hysteresis, not meant to be guaranteed.
(Assuming approximately $\pm 30\%$ dispersion.)
There may be the case it will vary substantially depending on an ambient environment.

Auto Switch Mounting

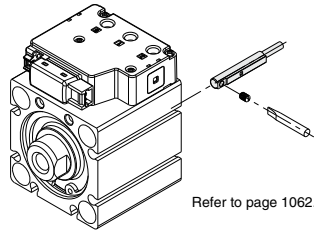

Refer to page 1062.

Minimum Stroke for Auto Switch Mounting

Bore size (mm)	No. of auto switch mounted	(mm)					
		D-M9□	D-M9□V	D-M9□W D-M9□A	D-M9□WV D-M9□AV	D-A9□	D-A9□V
32*1, 40	With 1 pc.	10 (5)	5	15 (10)	10	10 (5)	5
50*2, 63	With 2 pcs.	10 (5)	5	15	15	10	10

*1 The outline dimensions for 5 mm stroke will be the same as those for 10 mm stroke.

*2 The outline dimensions for 10 mm stroke will be the same as those for 15 mm stroke.

*3 () : Mountable minimum stroke when the auto switch protrudes from the cylinder body end face and does not interfere with the space for the lead wire.
(The figure on the right) Order separately for auto switches.

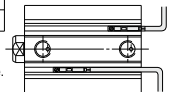



CVQ Series Specific Product Precautions 1

Be sure to read this before handling the products. Refer to back page 50 for Safety Instructions, pages 3 to 12 for Actuator and Auto Switch Precautions, and 3/4/5 Port Solenoid Valve Precautions in Best Pneumatics No. 1-1.

Manual Override

Warning

Connected actuator is started by manual operation. Use the manual override after confirming that there is no danger.

■ Non-locking push type [Standard]

Press in the direction of the arrow

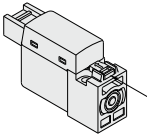

■ Locking slotted type [B type]

Turn 90° in the direction of arrow.

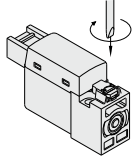

Caution

When operating with a screwdriver, turn it gently using a watchmaker's screwdriver. (Torque: Less than 0.1 N·m)

How to Use Plug Connector

Caution

1. Attaching and detaching connectors

- To attach a connector, hold the lever and connector unit between your fingers and insert straight onto the pins of the solenoid valve and remove the pawl from the groove by pushing the lever downward with your thumb, and pull the connector straight out.
- To detach a connector, remove the pawl from the groove by pushing the lever downward with your thumb, and pull the connector straight out.

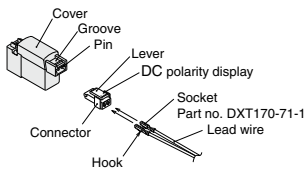

2. Crimping of lead wires and sockets

Not necessary if ordering the lead wire pre-connected model. Strip 3.2 to 3.7 mm at the end of the lead wires, insert the ends of the core wires evenly into the sockets, and then crimp with a crimping tool. When this is done, take care that the coverings of the lead wires do not enter the core wire crimping area.

For crimping, use a specific tool. (For special crimping tool, please contact SMC.)

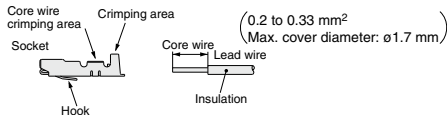

How to Use Plug Connector

Caution

2. Attaching and detaching sockets with lead wires

• Attaching

Insert the sockets into the square holes of the connector (⊕, ⊖ indication), and continue to push the sockets all the way in until they lock by hooking into the seats in the connector. (When they are pushed in, their hooks open and they are locked automatically.) Then confirm that they are locked by pulling lightly on the lead wires.

• Detaching

To detach a socket from a connector, pull out the lead wire while pressing the socket's hook with a stick having a thin tip (approx. 1 mm). If the socket will be used again, first spread the hook outward.

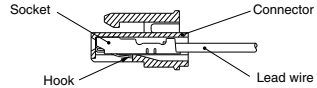

4. Do not apply bending force or tensile force repeatedly to the lead wire.

This can cause disconnection of the connector and breakage of the lead wire. If this is unavoidable due to the application, keep the bending radius of the lead wire R8 mm at least.

Surge Voltage Suppressor

Caution

■ Standard (with polarity)

With surge voltage suppressor (□S)

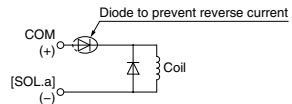

With light/surge voltage suppressor (□Z)

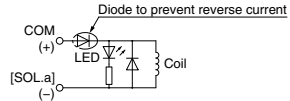

■ Non-polar type

With surge voltage suppressor (□R)

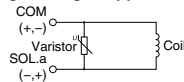

With light/surge voltage suppressor (□U)

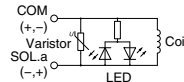

- For standard type, connect so that polarity is matched to the connector's (+), (-). (For non-polar type, the lead wires can be connected to either one.)

- Solenoids, whose lead wires have been pre-wired: positive side red and negative side black.

CVQ

CVQM

CVJ □

CVM □

CV3

CVS1

MVGQ

D-□

-X□



CVQ Series

Specific Product Precautions 2

Be sure to read this before handling the products. Refer to back page 50 for Safety Instructions, pages 3 to 12 for Actuator and Auto Switch Precautions, and 3/4/5 Port Solenoid Valve Precautions in Best Pneumatics No. 1-1.

Retaining Ring Installation/Removal

Caution

1. To remove and install the retaining ring, use an appropriate pair of pliers (tool for installing C-type retaining ring).
2. Even if a proper plier (tool for installing C-type retaining ring) is used, it is likely to inflict damage to a human body or peripheral equipment, as a retaining ring may be flown out of the tip of a plier (tool for installing C-type retaining ring). Be much careful with the popping of a retaining ring. Besides, be certain that a retaining ring is placed firmly into the groove of rod cover before supplying air at the time of installment.

Other

Caution

1. Do not separate the cylinder from the valve.

Mounting/Removal

Caution

1. Do not remove the plug from the cylinder tube end surface.
If the plug is removed with compressed air supplied to the cylinder, the air blowing out may inflict damage to a human body or peripheral equipment.