

Applicable Cylinder Series

Applicable Cylinder Series

Cylinder series		CHDQB	CHDKD				CHDKG	CHN	CHDM	CHDSD	CHDSG		CHD2E	CHD2F	CHD2H	CHDA										
Bore size		ø20 to ø100	ø20, ø25	ø32, ø40	ø50	ø63 to ø100	ø20, ø25	ø32 to ø100	ø20 to ø40	ø20 to ø40	ø40, ø50	ø63 to ø100	ø32	ø40 to ø80	ø100	ø32	ø40 to ø100	ø32	ø40 to ø100	ø32	ø40 to ø100	ø40, ø50	ø63	ø80, ø100		
Solid state auto switches	D-H7																									
	D-H7C																									
	D-H7BA																									
	D-H7NF																									
	D-H7□W																									
	D-G5/K5																									
	D-G5BA																									
	D-G59F																									
	D-G5NT																									
	D-G5□W/K59W																									
	D-G39/K39																									
	D-F7/J7																									
	D-J79C																									
	D-F79F																									
	D-F7BA																									
	D-F7BAV																									
	D-F7□V																									
	D-F7NT																									
	D-F7□W(V)																									
	D-F5/J59																									
	D-F5BA																									
	D-F5□W/J59W																									
	D-F59F																									
	D-F5NT																									
	D-M9																									
	D-M9□V																									
	D-M9□W																									
	D-M9□WV																									
	D-M9□A																									
	M9□AV																									
	D-Y5/Y6/Y7□Y7□V																									
	D-Y7BA																									
	D-Y7□W/Y7□WV																									
D-F9G/H (Normally closed)																										
D-Y7G/H (Normally closed)																										
Reed auto switches	D-C7/C8																									
	D-C73C/C80C																									
	D-B5/B6																									
	D-B59W																									
	D-A3/A4																									
	D-A7/A8																									
	D-A7□H/A80H																									
	D-A73C/A80C																									
	D-A79W																									
	D-A5/A6																									
	D-A59W																									
	D-A9																									
	D-A9□V																									
D-Z7/Z8																										
Actuator page reference		P.242	P.264				P.279	P.297	P.316	P.333	P.344		P.358 P.384		P.396											

Auto Switch Variations

Auto Switch Variations 1

Function	Type	Auto switch mounting type	Electrical entry	Auto switch model	Page	
General purpose auto switches	Solid state	Direct	Grommet	D-M9N/M9P/M9B*	442	
				D-M9NV/M9PV/M9BV*	442	
				D-F9G/F9H (Normally closed)*	443	
				D-Y59A/Y59B/Y7P**	444	
		D-Y69A/Y69B/Y7PV**	444			
		D-Y7G/Y7H (Normally closed)**	445			
		Band	Grommet	D-H7A1/H7A2/H7B	446	
				D-G59/G5P/K59	447	
				Connector	D-H7C	448
				Terminal conduit	D-G39/K39	449
		Rail	Grommet	D-F79/F7P/J79	450	
				D-F7NV/F7PV/F7BV	451	
		Tie-rod	Connector	D-J79C	452	
				Grommet	D-F59/F5P/J59	453
		Reed	Direct	Grommet	D-A90/A93/A96*	478
					D-A90V/A93V/A96V*	478
	D-Z73/Z76/Z80**				487	
	D-C73/C76/C80				479	
	Band		Grommet	D-B53/B54/B64	480	
				Connector	D-C73C/C80C	481
				Terminal conduit	D-A33/A34	482
				DIN terminal	D-A44	482
	Rail		Grommet	D-A72/A73/A80	483	
				D-A72H/A73H/A76H/A80H	484	
	Tie-rod		Connector	D-A73C/A80C	485	
				Grommet	D-A53/A54/A56/A64/A67	486

* These auto switches can be mounted with a band, a rail, a tie-rod or a square groove when auto switch mounting brackets are used. For details, refer to "How to Mount and Move the Auto Switch" of each series.

** These auto switches can be mounted with a tie-rod when auto switch mounting brackets are used. For details, refer to "How to Mount and Move the Auto Switch" of each series.

Band mounting



Rail mounting



Tie-rod mounting

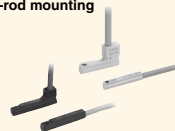

CHK

CHK

CHN

CHM

CHS

CH2

CHA

Related Products

D-

Auto Switch Variations

Auto Switch Variations 2

Function	Type	Auto switch mounting type	Electrical entry	Auto switch model	Page
2-color indicator	Solid state	Direct	Grommet	D-M9NW/M9PW/M9BW*	454
				D-M9NWV/M9PWV/M9BWV*	
		Band	Grommet	D-Y7NW/Y7PW/Y7BW**	455
				D-Y7NWV/Y7PWV/Y7BWV**	
		Rail	Grommet	D-H7NW/H7PW/H7BW	456
				D-G59W/G5PW/K59W	
		Tie-rod	Grommet	D-F79W/F7PW/J79W	458
				D-F7NWV/F7BWV	
	Tie-rod	Grommet	D-F59W/F5PW/J59W	460	
	Reed	Band	Grommet	D-B59W	488
		Rail	Grommet	D-A79W	489
		Tie-rod	Grommet	D-A59W	490

* These auto switches can be mounted with a band, a rail, a tie-rod or a square groove when auto switch mounting brackets are used. For details, refer to "How to Mount and Move the Auto Switch" of each series.

** These auto switches can be mounted with a tie-rod when auto switch mounting brackets are used. For details, refer to "How to Mount and Move the Auto Switch" of each series.

2-color indicator

Easily identifiable, proper operating range

● Mounting positions can be set easily.

Proper operating ranges can be set while watching the lights.

● Displacement of the detecting position can be visually checked.

Trouble caused by incorrect detection can be prevented beforehand.

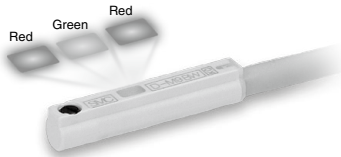
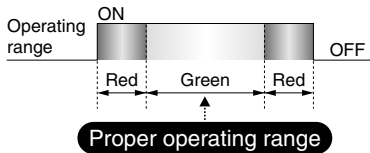

A green light lights up at the proper operating range.

Even if 2-color indicator solid state auto switches are fixed at the proper operating range (the green light lights up), the operation may become unstable depending on the installation environment or magnetic field disturbance. (Magnetic body, external magnetic field, proximal installation of cylinders with built-in magnet and actuators, temperature change, other factors for magnetic force fluctuation during operation, etc.)

Band mounting



Rail mounting



Tie-rod mounting



Direct mounting

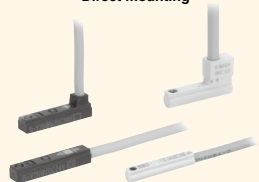

Function	Type	Auto switch mounting type	Electrical entry	Auto switch model	Page
The diagnostic output signal can be detected in an unsteady detecting area.					
2-color indicator auto switch with diagnostic output	Solid state	Band	Grommet	D-H7NF	461
		Rail	Grommet	D-G59F	462
		Tie-rod	Grommet	D-F79F	463
		Tie-rod	Grommet	D-F59F	464
Water resistant (coolant) type					
Water resistant 2-color indicator auto switch	Solid state	Direct	Grommet	D-M9□A*	465
		Direct	Grommet	D-M9□AV*	
		Band	Grommet	D-Y7BA**	466
		Band	Grommet	D-H7BA	467
		Band	Grommet	D-G5BA	468
		Rail	Grommet	D-F7BA	469
Rail	Grommet	D-F7BAV			
Tie-rod	Grommet	D-F5BA	470		
With built-in OFF-delay timer (200 ms)					
Auto switch with timer	Solid state	Band	Grommet	D-G5NT	471
		Rail	Grommet	D-F7NT	472
		Tie-rod	Grommet	D-F5NT	473

* These auto switches can be mounted with a band, a rail, a tie-rod or a square groove when auto switch mounting brackets are used. For details, refer to "How to Mount and Move the Auto Switch" of each series.

** These auto switches can be mounted with a tie-rod when auto switch mounting brackets are used. For details, refer to "How to Mount and Move the Auto Switch" of each series.

2-color indicator type with diagnostic output



Water resistant 2-color indicator type

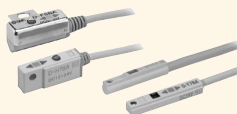

With timer

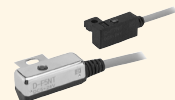

Prior to Use

Auto Switches Common Specifications 1

Refer to the Auto Switch Precautions on pages 217 to 221 before using auto switches.

Auto Switches Common Specifications

Type	Reed auto switch	Solid state auto switch
Leakage current	None	3-wire: 100 μ A or less, 2-wire: 0.8 mA or less
Operating time	1.2 ms	1ms or less *3)
Impact resistance	300 m/s ²	1000 m/s ² *4)
Insulation resistance	50 M Ω or more (500 VDC measured via megohmmeter) (Between lead wire and case)	
Withstand voltage	1500 VAC for 1 minute *1) (Between lead wire and case)	1000 VAC for 1 minute (Between lead wire and case)
Ambient temperature	-10 to 60°C	
Enclosure	IEC60529 Standard IP67 *2)	

- * 1) Electrical entry: Connector type (A73C/A80C/C73C/C80C): 1000 VAC/min. (Between lead wire and the case)
- * 2) The terminal conduit type (D-A3/A3 \square /A3 \square C/G39/G39A/G39C/K39/K39A/K39C), DIN terminal type (D-A44/A44A/A44C) and heat resistant auto switch (D-F7NJ) conform to IEC60529 Standard IP63.
The trimmer type amplifier section (D-R \square K) conforms to IP40.
- * 3) Excluding the solid state auto switches with a timer (D-M5 \square T/G5NT/F7NT/F5NT types) and magnetic field resistant 2-color indicator solid state auto switch (D-P3DW \square /P4DW).
The operating time for D-J51 is 2 ms or less and for D-P3DW \square /P4DW are 40 ms or less.
- * 4) 980 m/s² for the trimmer type sensor section, 98 m/s² for the amplifier section.

Lead Wire

Lead wire length indication

(Example)

D-M9BW L

Auto switch model

Lead wire length

Symbol	Length	Tolerance	Connector specifications	Solid state	Reed
Nll	0.5 m	\pm 15 mm		●	●
M	1 m	\pm 30 mm		● *2)	● *2)
L	3 m	\pm 90 mm		●	●
Z	5 m	\pm 150 mm		●	● *3)
N *1)	None	—		●	●
SAPC	0.5 m	\pm 15 mm	M8-3 pin	○	—
MAPC	1 m	\pm 30 mm	Plug connector	○	—
SBPC	0.5 m	\pm 15 mm	M8-4 pin	○	—
MBPC	1 m	\pm 30 mm	Plug connector	○	—
SDPC	0.5 m	\pm 15 mm	M12-4 pin A code (Normal key) Plug connector	○	—
MDPC	1 m	\pm 30 mm		○	—
LDPC	3 m	\pm 90 mm		○	—

●: Standard ○: Produced upon receipt of order (Standard)

- * 1) Applicable to the connector type (D- \square C) only.
- * 2) Applicable to the D-M9 \square (V), D-M9 \square W (V), D-M9 \square A (V), and D-A93 only.
- * 3) Applicable to the D-B53/B54, D-C73(C)/C80C, D-A93(V), D-A73(C)/A80C, D-A53/A54, D-Z73, and D-90/97/90A/93A only.
- * 4) For reed auto switches M8 and M12 type with connector, please contact SMC.
- * 5) The standard lead wire length of the trimmer auto switch is 3 m.
- * 6) The standard lead wire length of the solid state auto switch with the timer except for the D-P3DW and D-M9 \square A (V) \square , water-resistant 2-color display solid state auto switch, wide range detection auto switch, heat resistant 2-color display solid state auto switch, and strong magnetic field resistant 2-color display solid state auto switch is 3 m or 5 m. (Product with a lead wire length of 0.5 m is not available.)

Lead wires with a connector indication

Part No. of Lead Wires with Connectors
(Applicable only for connector type)

Model	Lead wire length
D-LC05	0.5 m
D-LC30	3 m
D-LC50	5 m

Prior to Use

Auto Switches Common Specifications 2

Refer to the Auto Switch Precautions on pages 217 to 221 before using auto switches.

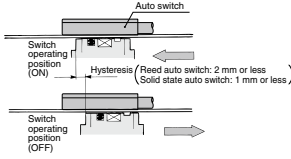
Term	Meaning
Hysteresis	 <p>A deviation amount between the ON position and OFF position caused by auto switch characteristics (difference in sensitivity between ON and OFF). When the switch is turned ON once and the switch (or piston) is moved in the opposite direction, a symptom occurs that the position where the switch turns OFF deviates to a position where it is further returned from the ON position. This deviation amount is called "hysteresis".</p> <p>Note) Hysteresis may fluctuate due to the operating environment. Please contact SMC if hysteresis causes an operational problem.</p>
Most sensitive position	A position (sensor layout position) where the sensitivity is highest on the detection surface of the auto switch enclosure. When the center of the magnet is aligned with this position, this becomes almost the center of the operating range and stable operation can be obtained.
Programmable Logic Controller (PLC)	One of elements making up the sequence control. The PLC is so designed that it receives signals, such as auto switch output and outputs them to other devices so as to perform the electrical control according to the preset program.
Operating temperature range	A temperature range, in which the auto switch can be used. If significant temperature change or freezing occurs even in this temperature range, this may cause the auto switch to malfunction.
Operating voltage	A voltage, at which the auto switch can be used. The operating voltage is indicated using generally used voltage (24 VDC or 100 VAC, etc.). For 2-wire type, the operating voltage has the same meaning as the power supply voltage or load voltage.
Operating current range	A range of the current value that can be flowed to the output of the auto switch. If the operating current is lower than this range, the auto switch does not operate correctly. Conversely, if the operating current is higher than this range, this may cause the auto switch to break.
Current consumption	This current value is necessary for the 3-wire type auto switch to operate the circuit through the power cable. For 2-wire type, as the current consumption is a part of the load current, it is not defined.
Insulation resistance	A resistance between the electric circuit and enclosure. Unless otherwise described particularly, 50 M Ω (Min) is used for auto switch.
Magnetic field resistant auto switch	An auto switch, for which measures against effects arising from external (welding) magnetic field generated in the spot welding process, etc. are taken. The solid state auto switch functions as it detects the frequency of the applied magnetic field. If the external magnetic field (AC) is applied, the last signal is retained not to be affected by the external magnetic field. This system can be used by the cylinder with normal magnetic force. The reed auto switch built-in a magnetic field shielded sensor with a low sensitivity to make the effect of the external magnetic field (DC or AC magnetic field) insusceptible. Therefore, a dedicated cylinder built-in the strong magnet needs to be selected and there is also an operable range (conditions).
Impact resistance value	A minimum acceleration that may cause the auto switch to malfunction or break when the standard impact is applied.
Water-resistant type auto switch	A model, long-term water resistance of which is improved by taking structural measures for the general (general purpose) product.
Withstand voltage	A tolerance dose when the voltage is applied to the portion between the electrical circuit and enclosure. The withstand voltage shows a strength level of the product against the voltage. If a voltage exceeding the withstand voltage is applied, this may cause the product to break. (The voltage described here is different from the power supply voltage necessary to operate the product.)
Proper mounting position	A dimension that shows the mounting position when the position is detected at the stroke end of the cylinder. As this position is set, the maximum sensitivity position is aligned with the center of the magnet. However, make the adjustment with the actual machine by considering the characteristic difference during actual setting. When an adjustment allowance is needed for the detection before the stroke, set a value with an adjustment allowance added to the proper mounting position.
Applicable load	A device that is assumed as a target load of the auto switch.
Operating time	A period of time until the auto switch output becomes stable after the magnetic force to operate the auto switch has been received.
Operating range	An auto switch operating range in response to the cylinder piston movement (ON length in response to the stroke). The operating range is determined by the magnetic force of the magnet (range, in which the magnetic force acts) and switch sensitivity. So, the operating range may vary as these conditions are changed by the ambient environment, etc. The operating range in the standard status (normal temperature, single cylinder, magnetic force, and sensitivity, etc.) is described in the catalog.

CHQ

CHK

CHN

CHM

CHS

CHZ

CHA

Related Products

D-

Prior to Use

Auto Switches Common Specifications 3

Refer to the Auto Switch Precautions on pages 217 to 221 before using auto switches.

Term	Meaning																																
Minimum Stroke for Auto Switch Mounting	A minimum stroke value of the auto switch that can be mounted on the cylinder. The minimum stroke is determined by the specification limit (auto switch operation or position setting ability, etc.) and physical limit (mechanical interference associated with the auto switch mounting). Note that the catalog shows the value assuming that the position detection is performed at the stroke end and this value does not consider the adjustment allowance. When an adjustment allowance is needed, such as detection before the stroke, a value is set that this adjustment allowance is added to the minimum stroke.																																
Internal voltage drop	A voltage that is applied to the portion between the COM and signal line when the auto switch is ON. As only a value that the internal voltage drop is subtracted from the power supply voltage is applied to the input side of the PLC, the detection fault (incorrect input) may occur if this value is lower than the minimum operating voltage. So, take great care when selecting a device.																																
2-Color Indicator	As the end part of the auto switch operating range (boundary between ON and OFF) is an area where is susceptible to the external disturbance or stroke change during cylinder operation, this function is intended to quickly and properly make the setting at the center of the operating range where the stable operation can be obtained by changing the operation indication color of the auto switch.																																
Load	A device that is connected to the output of the auto switch so as to do any work is called "load". For example, the load is a relay or PLC, etc. To check the operation of the auto switch, a device equivalent to the load (such as resistor, etc.) is connected.																																
Load current	A current that flows to the load when the ON-OFF output is ON.																																
Enclosure	<p>A class of protection against solid or water entry of the electrical machinery and apparatus specified in IEC60529.</p> <p>IP—</p> <p>↓ Second characteristic numeral ↓ First characteristic numeral</p> <p>●First Characteristics: Degrees of protection against solid foreign objects</p> <table border="1"> <tbody> <tr><td>0</td><td>Non-protected</td></tr> <tr><td>1</td><td>Protected against solid foreign objects of 50 mm ø and greater</td></tr> <tr><td>2</td><td>Protected against solid foreign objects of 12 mm ø and greater</td></tr> <tr><td>3</td><td>Protected against solid foreign objects of 2.5 mm ø and greater</td></tr> <tr><td>4</td><td>Protected against solid foreign objects of 1.0 mm ø and greater</td></tr> <tr><td>5</td><td>Dust-protected</td></tr> <tr><td>6</td><td>Dusttight</td></tr> </tbody> </table> <p>●Second Characteristics: Degrees of protection against water</p> <table border="1"> <tbody> <tr><td>0</td><td>Non-protected</td></tr> <tr><td>1</td><td>Protected against vertically falling water drops</td></tr> <tr><td>2</td><td>Protected against vertically falling water drops when enclosure tilted up to 15°</td></tr> <tr><td>3</td><td>Protected against rainfall when enclosure tilted up to 60°</td></tr> <tr><td>4</td><td>Protected against splashing water</td></tr> <tr><td>5</td><td>Protected against water jets</td></tr> <tr><td>6</td><td>Protected against powerful water jets</td></tr> <tr><td>7</td><td>Protected against the effects of temporary immersion in water</td></tr> <tr><td>8</td><td>Protected against the effects of continuous immersion in water</td></tr> </tbody> </table> <p>Example) In the case of stipulated as IP65, we can know the degrees of protection is dusttight and water jet-proof on the grounds that the first characteristic numeral is 6 and the second characteristic numeral is 5 respectively, that gives it will not be adversely affected by direct water jets from any direction.</p>	0	Non-protected	1	Protected against solid foreign objects of 50 mm ø and greater	2	Protected against solid foreign objects of 12 mm ø and greater	3	Protected against solid foreign objects of 2.5 mm ø and greater	4	Protected against solid foreign objects of 1.0 mm ø and greater	5	Dust-protected	6	Dusttight	0	Non-protected	1	Protected against vertically falling water drops	2	Protected against vertically falling water drops when enclosure tilted up to 15°	3	Protected against rainfall when enclosure tilted up to 60°	4	Protected against splashing water	5	Protected against water jets	6	Protected against powerful water jets	7	Protected against the effects of temporary immersion in water	8	Protected against the effects of continuous immersion in water
0	Non-protected																																
1	Protected against solid foreign objects of 50 mm ø and greater																																
2	Protected against solid foreign objects of 12 mm ø and greater																																
3	Protected against solid foreign objects of 2.5 mm ø and greater																																
4	Protected against solid foreign objects of 1.0 mm ø and greater																																
5	Dust-protected																																
6	Dusttight																																
0	Non-protected																																
1	Protected against vertically falling water drops																																
2	Protected against vertically falling water drops when enclosure tilted up to 15°																																
3	Protected against rainfall when enclosure tilted up to 60°																																
4	Protected against splashing water																																
5	Protected against water jets																																
6	Protected against powerful water jets																																
7	Protected against the effects of temporary immersion in water																																
8	Protected against the effects of continuous immersion in water																																
Solid state auto switch	A switch that detects the magnetic field by the MR element and incorporates the judgement circuit to turn ON or OFF the output regardless of the contact or non-contact of the mechanical contact like transistor (non-contact part).																																
Leak current	A current that flows to operate the internal circuit when the ON-OFF output is OFF. In particular, if this leak current exceeds the detection current in the 2-wire type auto switch or PLC, this may cause reset fault. So, take great care when selecting a device.																																
Reed auto switch	A switch that uses the reed switch to detect the magnetic field and turn ON or OFF the output by the contact or non-contact of the mechanical contact (contact part is provided like relay or limit switch).																																
Induction load	A load that has the coil. The connection target of the auto switch is a relay.																																
Recommended lead wire bending radius	A minimum bending radius (reference value) of the lead wire when the lead wire is secured and constructed (oscillation or rotation is not considered). (As the temperature or current value conforms to the auto switch specifications, this lead wire bending radius differs from the value disclosed by the electric wire manufacturer.)																																
Electrical entry	A structure, in which the lead wire of the auto switch is taken out in the horizontal direction when the cylinder is laid out horizontally (cylinder rod is horizontal), is called "in-line entry". A structure, in which the lead wire is taken out in a direction perpendicular to the cylinder axis center, is called "perpendicular entry".																																

Prior to Use

Auto Switches/Internal Circuit

Solid State Auto Switches

Solid state 3-wire, NPN

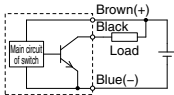

Solid state 3-wire, PNP

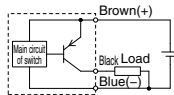

2-wire (Solid state)

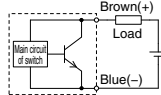

(Power supply for switch and load are separate)

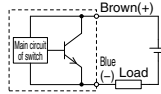
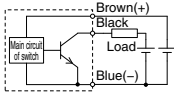

Reed Auto Switches

No.	①	②	③	④
Circuit diagram	2-wire (Reed switch) 	2-wire (Reed switch) 	2-wire (Reed switch) 	2-wire (Reed switch)
No.	⑤	⑥	⑦	
Circuit diagram	3-wire (Reed switch, NPN) 	2-wire (Reed switch) 	2-wire (Reed switch) 	

Contact Protection Box/CD-P11, CD-P12

<Applicable switch models>

D-A7/A8, D-A7□H/A80H, D-A73C, A80C, D-C7/C8, D-C73C/C80C, D-E7□A, E80A, D-Z7/Z8, D-9/9□A, D-A9/A9□V, D-A79W

The auto switches above do not have a built-in contact protection circuit.

A contact protection box is not required for solid state auto switches due to their construction.

1. Where the operation load is an inductive load.
2. Where the wiring length to load is greater than 5 m.
3. Where the load voltage is 100/200 VAC.

Therefore, use a contact protection box with the switch for any of the above cases:

The contact life may be shortened (due to permanent energizing conditions.)

D-A72(H) must be used with the contact protection box regardless of load types and lead wire length since it is greatly affected by loads.

(Where the load voltage is 110 VAC)

When the load voltage is increased by more than 10% to the rating of applicable auto switches (except D-A73C/A80C/C73C/C80C/90/97/A79W) above, use a contact protection box (CD-P11) to reduce the upper limit of the load current by 10% so that it can be set within the range of the load current range, 110 VAC.

Even for the built-in contact protection circuit type (D-A34[A][C], DA44[A][C], D-A54/A64, D-A59W, D-B59W), use the contact protection box when the wiring length to load is very long (over 30 m) and PLC (Programmable Logic Controller) with a large inrush current is used.

Contact Protection Box Connection

To connect a switch unit to a contact protection box, connect the lead wire from the side of the contact protection box marked SWITCH to the lead wire coming out of the switch unit. Keep the switch as close as possible to the contact protection box, with a lead wire length of no more than 1 meter.

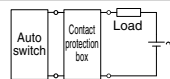

Contact Protection Box Specifications

Part no.	CD-P11	CD-P12
Load voltage	100 VAC or less	200 VAC 24 VDC
Max. load current	25 mA 12.5 mA	50 mA

※Lead wire length — Auto switch connection side 0.5 m
Load connection side 0.5 m

Contact Protection Box Internal Circuit

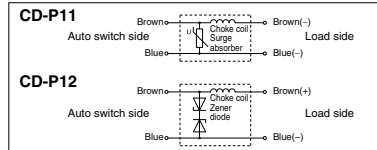

Contact Protection Box/Dimensions

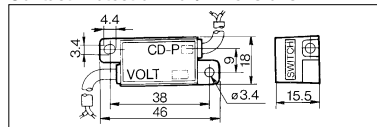

CHQ

CHK□

CHN

CHM

CHS□

CHZ□

CHA

Related Products

D-□

Prior to Use

Auto Switch Connection and Example

Sink Input Specifications

3-wire, NPN

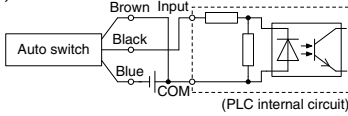

2-wire

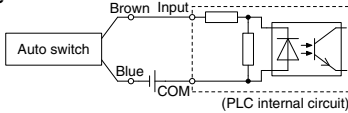

Source Input Specifications

3-wire, PNP

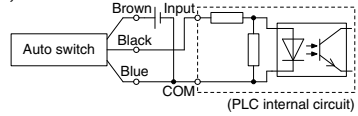

2-wire

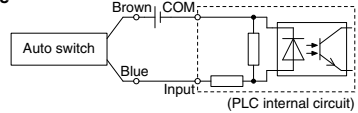

Connect according to the applicable PLC input specifications, as the connection method will vary depending on the PLC input specifications.

Example of AND (Series) and OR (Parallel) Connection

* When using solid state auto switches, ensure the application is set up so the signals for the first 50 ms are invalid. Depending on the operating environment, the product may not operate properly.

3-wire AND connection for NPN output (Using relays)

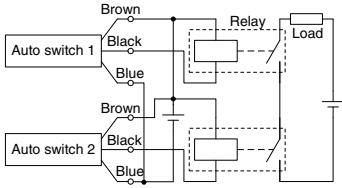

(Performed with auto switches only)

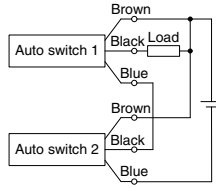

3-wire OR connection for NPN output

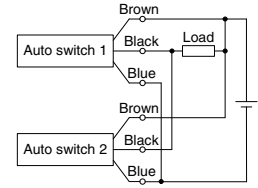

3-wire AND connection for PNP output (Using relays)

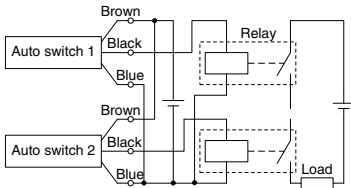

(Performed with auto switches only)

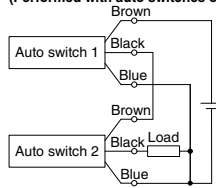

3-wire OR connection for PNP output

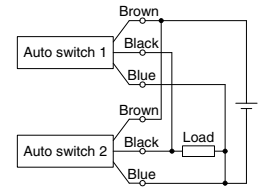

2-wire AND connection

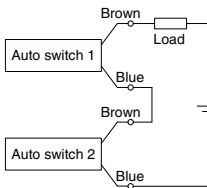

When two auto switches are connected in series, a load may malfunction because the load voltage will decline when in the ON state. The indicator lights will light up when both of the auto switches are in the ON state. Auto switches with load voltage less than 20V cannot be used.

Load voltage at ON = Power supply voltage – Residual voltage x 2 pcs.
= 24 V – 4 V x 2 pcs.
= 16 V

Example: Power supply is 24 VDC
Internal voltage drop in auto switch is 4 V.

2-wire OR connection

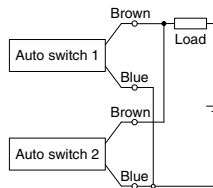

(Solid state)
When two auto switches are connected in parallel, malfunction may occur because the load voltage will increase when in the OFF state.

(Reed)
Because there is no current leakage, the load voltage will not increase when turned OFF. However, depending on the number of auto switches in the ON state, the indicator lights may sometimes grow dim or not light up, due to the dispersion and reduction of the current flowing to the auto switches.

Load voltage at OFF = Leakage current x 2 pcs. x Load impedance
= 1 mA x 2 pcs. x 3 kΩ
= 6 V

Example: Load impedance is 3 kΩ.
Leakage current from auto switch is 1 mA.

Solid State Auto Switches

General Purpose Type, 2-color Indicator Type, 2-color Indicator Type with Diagnostic Output, Water Resistant 2-color Indicator Type, Timer Equipped Type, Wide Range Detection Type

Solid State Auto Switch Variations

Type	Function	Auto switch mounting type	Electrical entry	Auto switch model	Page	
Solid State Auto Switch	General purpose	Direct	Grommet	D-M9N/M9P/M9B	442	
				D-M9NV/M9PV/M9BV		
				D-F9G/F9H (Normally closed)	443	
				D-Y59A/Y59B/Y7P		
				D-Y69A/Y69B /Y7PV		
		D-Y7G/Y7H (Normally closed)	445			
		Band	Grommet	D-H7A1/H7A2/H7B	446	
				D-G59/G5P/K59	447	
				Connector	D-H7C	448
				Terminal conduit	D-G39/K39	449
	Grommet			D-F79/F7P/J79	450	
	Rail	Connector	D-F7NV/F7PV/F7BV	451		
			D-J79C	452		
			D-F59/F5P/J59	453		
	Tie-rod	Grommet				
	2-color indicator	Direct	Grommet	D-M9NW/M9PW/M9BW	454	
				D-M9NVV/M9PVV/M9BWW		
				D-Y7NW/Y7PW/Y7BW	455	
				D-Y7NWW/Y7PWW/Y7BWW		
				D-H7NW/H7PWH7BW		
Band		Grommet	D-G59W/G5PW/K59W	456		
			D-F79W/F7PW/J79W	457		
			D-F7NWV/F7BWW	458		
			D-F7NWWV/F7BWW	459		
			D-F59W/F5PW/J59W	460		
Rail	Grommet	D-H7NF	461			
		D-G59F	462			
		D-F79F	463			
Tie-rod	Grommet	D-F59F	464			
2-color indicator with diagnostic output	Band	Grommet	D-M9NA/M9PA/M9BA	465		
			D-M9NAV/M9PAV/M9BAV			
			D-Y7BA	466		
			D-H7BA			
			D-G5BA		467	
	Rail	Grommet	D-F7BA	468		
			D-F7BAV			
			D-F5BA	469		
			D-F5BA			
			D-F5BA			
Tie-rod	Grommet	D-F5BA	470			
		D-F5BA				
		D-F5BA				
With timer	Band	Grommet	D-G5NT	471		
			D-F7NT	472		
			D-F5NT	473		

CHK

CHK

CHN

CHM

CHS

CH2

CHA

Related Products

D-

Solid State Auto Switch Direct Mounting Type

D-M9N(V)/D-M9P(V)/D-M9B(V)



Grommet

- 2-wire load current is reduced (2.5 to 40 mA).
- Using flexible cable as standard spec.



⚠ Caution

Precautions

Fix the auto switch with the existing screw installed on the auto switch body. The auto switch may be damaged if a screw other than the one supplied is used.

Auto Switch Specifications

Refer to SMC website for the details of the products conforming to the international standards.

PLC: Programmable Logic Controller

D-M9□, D-M9□V (With indicator light)						
Auto switch model	D-M9N	D-M9NV	D-M9P	D-M9PV	D-M9B	D-M9BV
Electrical entry direction	In-line	Perpendicular	In-line	Perpendicular	In-line	Perpendicular
Wiring type	3-wire					2-wire
Output type	NPN			PNP		—
Applicable load	IC circuit, Relay, PLC				24 VDC relay, PLC	
Power supply voltage	5, 12, 24 VDC (4.5 to 28 V)					—
Current consumption	10 mA or less					—
Load voltage	28 VDC or less			—		24 VDC (10 to 28 VDC)
Load current	40 mA or less					2.5 to 40 mA
Internal voltage drop	0.8 V or less at 10 mA (2 V or less at 40 mA)					4 V or less
Leakage current	100 μA or less at 24 VDC					0.8 mA or less
Indicator light	Red LED illuminates when turned ON.					
Standard	CE marking, RoHS					

Oilproof Heavy-duty Lead Wire Specifications

Auto switch model		D-M9N(V)	D-M9P(V)	D-M9B(V)
Sheath	Outside diameter [mm]	2.6		
Insulator	Number of cores	3 cores (Brown/Blue/Black)		2 cores (Brown/Blue)
	Outside diameter [mm]	0.88		
Conductor	Effective area [mm ²]	0.15		
	Strand diameter [mm]	0.05		
Minimum bending radius [mm] (Reference values)		17		

Note 1) Refer to page 436 for solid state auto switch common specifications.

Note 2) Refer to page 436 for lead wire lengths.

Weight

(g)

Auto switch model		D-M9N(V)	D-M9P(V)	D-M9B(V)
Lead wire length	0.5 m (Nii)	8	7	7
	1 m (M)	14	13	13
	3 m (L)	41	38	38
	5 m (Z)	68	63	63

Dimensions

(mm)

D-M9□

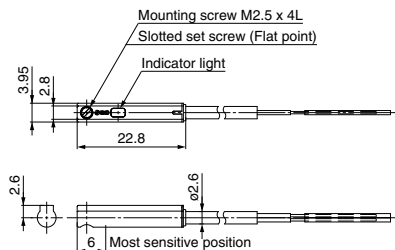

D-M9□V

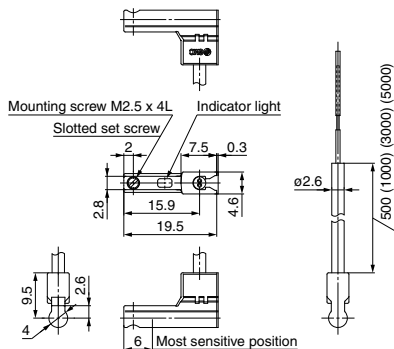

Normally Closed Solid State Auto Switch Direct Mounting Type D-F9G/D-F9H



Refer to SMC website for the details of the products conforming to the international standards.

Grommet

Output signal turns on when no magnetic force is detected.



Caution

Precautions

Fix the auto switch with the existing screw installed on the auto switch body. The auto switch may be damaged if a screw other than the one supplied is used.

Auto Switch Specifications

PLC: Programmable Logic Controller

D-F9G, D-F9H (With indicator light)		
Auto switch model	D-F9G	D-F9H
Wiring type	3-wire	
Output type	NPN	PNP
Applicable load	IC circuit, Relay, PLC	
Power supply voltage	5, 12, 24 VDC (4.5 to 28 VDC)	
Current consumption	10 mA or less	
Load voltage	28 VDC or less	—
Load current	40 mA or less	80 mA or less
Internal voltage drop	1.5 V or less (0.8 V or less at 10 mA load current)	0.8 V or less
Leakage current	100 μ A or less at 24 VDC	
Indicator light	Red LED illuminates when detecting nothing.	
Standard	CE marking, RoHS	

Oilproof Heavy-duty Lead Wire Specifications

Auto switch model		D-F9G	D-F9H
Sheath	Outside diameter [mm]	ϕ 2.7	
Insulator	Number of cores	3 cores (Brown/Blue/Black)	
	Outside diameter [mm]	ϕ 0.91	
Conductor	Effective area [mm ²]	0.15	
	Strand diameter [mm]	ϕ 0.08	
Minimum bending radius [mm] (Reference values)		17	

Note 1) Refer to page 436 for solid state auto switch common specifications.

Note 2) Refer to page 436 for lead wire lengths.

Weight

(g)

Auto switch model		D-F9G	D-F9H
Lead wire length	0.5 m (NII)	7	
	3 m (L)	37	
	5 m (Z)	61	

Dimensions

(mm)

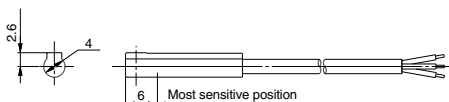
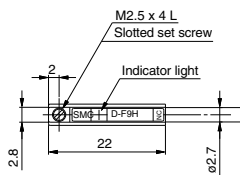

Normally Closed Solid State Auto Switch Direct Mounting Type D-Y7G/D-Y7H



Refer to SMC website for the details of the products conforming to the international standards.

Grommet

- Output signal turns on when no magnetic force is detected.
- Using flexible cable as standard spec.



Auto Switch Specifications

PLC: Programmable Logic Controller

D-Y7G, D-Y7H (With indicator light)		
Auto switch model	D-Y7G	D-Y7H
Wiring type	3-wire	
Output type	NPN	PNP
Applicable load	IC circuit, Relay, PLC	
Power supply voltage	5, 12, 24 VDC (4.5 to 28 VDC)	
Current consumption	10 mA or less	
Load voltage	28 VDC or less	—
Load current	40 mA or less	80 mA or less
Internal voltage drop	1.5 V or less (0.8 V or less at 10 mA load current)	0.8 V or less
Leakage current	100 μ A or less at 24 VDC	
Indicator light	Red LED illuminates when detecting nothing.	
Standard	CE marking, RoHS	

Oilproof Flexible Heavy-duty Lead Wire Specifications

Auto switch model		D-Y7G	D-Y7H
Sheath	Outside diameter [mm]	ϕ 3.4	
Insulator	Number of cores	3 cores (Brown/Blue/Black)	
	Outside diameter [mm]	ϕ 1.0	
Conductor	Effective area [mm ²]	0.15	
	Strand diameter [mm]	ϕ 0.05	
Minimum bending radius [mm] (Reference values)		21	

Note 1) Refer to page 436 for solid state auto switch common specifications.
Note 2) Refer to page 436 for lead wire lengths.

Weight

(g)

Auto switch model		D-Y7G	D-Y7H
Lead wire length	0.5 m (NII)	10	
	3 m (L)	53	
	5 m (Z)	87	

Dimensions

(mm)

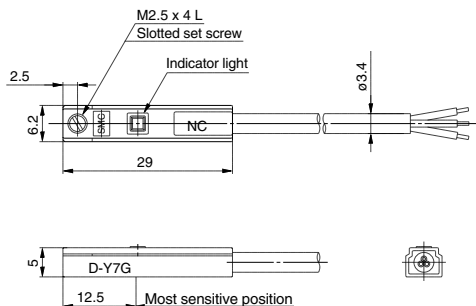

Solid State Auto Switch Band Mounting Type

D-H7A1/D-H7A2/D-H7B



Refer to SMC website for the details of the products conforming to the international standards.

Grommet



Auto Switch Specifications

PLC: Programmable Logic Controller

D-H7□ (With indicator light)			
Auto switch model	D-H7A1	D-H7A2	D-H7B
Wiring type	3-wire		2-wire
Output type	NPN	PNP	—
Applicable load	IC circuit, Relay, PLC		24 VDC Relay, PLC
Power supply voltage	5, 12, 24 VDC (4.5 to 28 VDC)		—
Current consumption	10 mA or less		—
Load voltage	28 VDC or less	—	24 VDC (10 to 28 VDC)
Load current	40 mA or less	80 mA or less	5 to 40 mA
Internal voltage drop	1.5 V or less (0.8 V or less at 10 mA load current)	0.8 V or less	4 V or less
Leakage current	100 μ A or less at 24 VDC		0.8 mA or less at 24 VDC
Indicator light	Red LED illuminates when turned ON.		
Standard	CE marking, RoHS		

Oilproof Heavy-duty Lead Wire Specifications

Auto switch model		D-H7A1	D-H7A2	D-H7B
Sheath	Outside diameter [mm]	ϕ 3.4		
Insulator	Number of cores	3 cores (Brown/Blue/Black)		2 cores (Brown/Blue)
	Outside diameter [mm]	ϕ 1.1		
Conductor	Effective area [mm ²]	0.2		
	Strand diameter [mm]	ϕ 0.08		
Minimum bending radius [mm] (Reference values)		21		

Note 1) Refer to page 436 for solid state auto switch common specifications.
Note 2) Refer to page 436 for lead wire lengths.

Weight

(g)

Auto switch model		D-H7A1	D-H7A2	D-H7B
Lead wire length	0.5 m (NII)	13		11
	3 m (L)	57		50
	5 m (Z)	92		81

Dimensions

(mm)

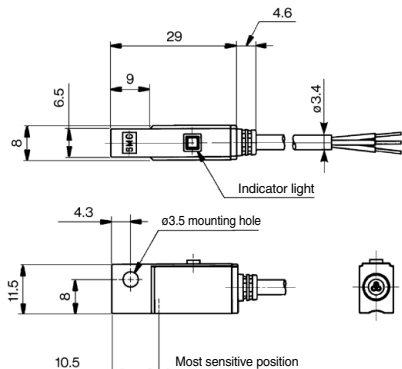

Solid State Auto Switch Band Mounting Type D-G59/D-G5P/D-K59



Refer to SMC website for the details of the products conforming to the international standards.

Grommet



Auto Switch Specifications

PLC: Programmable Logic Controller

D-G5□, D-K59 (With indicator light)			
Auto switch model	D-G59	D-G5P	D-K59
Wiring type	3-wire		2-wire
Output type	NPN	PNP	—
Applicable load	IC circuit, Relay, PLC		24 VDC Relay, PLC
Power supply voltage	5, 12, 24 VDC (4.5 to 28 VDC)		
Current consumption	10 mA or less		
Load voltage	28 VDC or less	—	24 VDC (10 to 28 VDC)
Load current	40 mA or less	80 mA or less	5 to 40 mA
Internal voltage drop	1.5 V or less (0.8 V or less at 10 mA load current)	0.8 V or less	4 V or less
Leakage current	100 μA or less at 24 VDC		0.8 mA or less at 24 VDC
Indicator light	Red LED illuminates when turned ON.		
Standard	CE marking, RoHS		

Oilproof Heavy-duty Lead Wire Specifications

Auto switch model		D-G59	D-G5P	D-K59
Sheath	Outside diameter [mm]	ø4		
Insulator	Number of cores	3 cores (Brown/Blue/Black)		2 cores (Brown/Blue)
	Outside diameter [mm]	ø1.22		
Conductor	Effective area [mm ²]	0.3		
	Strand diameter [mm]	ø0.08		
Minimum bending radius [mm] (Reference values)		24		

Note 1) Refer to page 436 for solid state auto switch common specifications.
Note 2) Refer to page 436 for lead wire lengths.

Weight

(g)

Auto switch model		D-G59	D-G5P	D-K59
Lead wire length	0.5 m (NII)	20		18
	3 m (L)	78		68
	5 m (Z)	124		108

Dimensions

(mm)

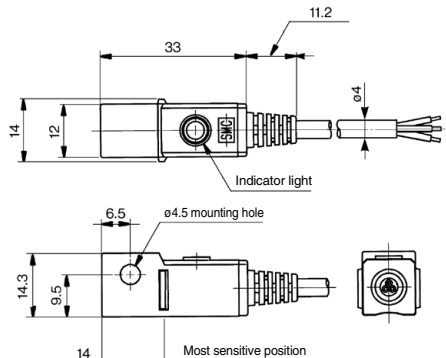

CHK

CHK□

CHN

CHM

CHS□

CH2□

CHA

Related Products

D-□

Solid State Auto Switch Band Mounting Type D-H7C



Refer to SMC website for the details of the products conforming to the international standards.

Connector



Caution

Precautions

1. Confirm that the connector is appropriately tightened. If tightened insufficiently, the waterproof performance will deteriorate.
2. Refer to Best Pneumatics No. 2-1 for the details.

Lead wires with a connector indication

Part No. of Lead Wires with Connectors
(Applicable only for connector type)

Model	Lead wire length
D-LC05	0.5 m
D-LC30	3 m
D-LC50	5 m

Auto Switch Specifications

PLC: Programmable Logic Controller

D-H7C (With indicator light)	
Auto switch model	D-H7C
Wiring type	2-wire
Output type	—
Applicable load	24 VDC Relay, PLC
Power supply voltage	—
Current consumption	—
Load voltage	24 VDC (10 to 28 VDC)
Load current	5 to 40 mA
Internal voltage drop	4 V or less
Leakage current	0.8 mA or less at 24 VDC
Indicator light	Red LED illuminates when turned ON.
Standard	CE marking, RoHS

Note 1) Refer to page 436 for solid state auto switch common specifications.

Note 2) Refer to page 436 for lead wire lengths.

Note 3) Lead wires with a connector may be shipped with switches.

Weight

(g)

Auto switch model		D-H7C
Lead wire length	0.5 m (Nil)	15
	3 m (L)	54
	5 m (Z)	85

Dimensions

(mm)

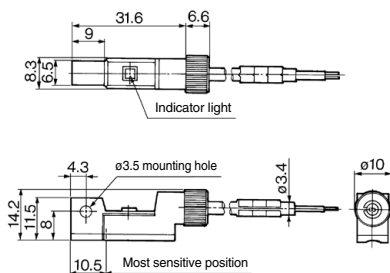

Solid State Auto Switch Band Mounting Type D-G39/D-K39



Refer to SMC website for the details of the products conforming to the international standards.

Terminal conduit



Caution

Precautions

1. Use cable whose O.D. is within the size in the figure to maintain water resistant performance.
2. After wiring, confirm that tightening gland and all screws are tightened.

Auto Switch Specifications

PLC: Programmable Logic Controller

D-G39, D-K39 (With indicator light)		
Auto switch model	D-G39	D-K39
Wiring type	3-wire	2-wire
Output type	NPN	—
Applicable load	IC circuit, Relay, PLC	24 VDC Relay, PLC
Power supply voltage	5, 12, 24 VDC (4.5 to 28 VDC)	—
Current consumption	10 mA or less	—
Load voltage	28 VDC or less	24 VDC (10 to 28 VDC)
Load current	40 mA or less	5 to 40 mA
Internal voltage drop	1.5 V or less (0.8 V or less at 10 mA of load current)	4 V or less
Leakage current	100 μ A or less at 24 VDC	0.8 mA or less at 24 VDC
Indicator light	Red LED illuminates when turned ON.	
Standard	CE marking, RoHS	

Note) Refer to page 436 for solid state auto switch common specifications.

CHK

CHK

CHN

CHM

CHS

CH2

CHA

Related Products

D-

Weight

(g)

Auto switch model		D-G39	D-K39
Lead wire	None	116	

Dimensions

(mm)

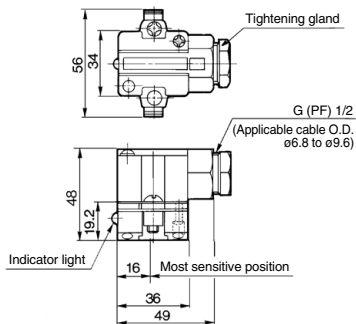

Solid State Auto Switch Rail Mounting Type D-F79/D-F7P/D-J79



Refer to SMC website for the details of the products conforming to the international standards.

Grommet



Auto Switch Specifications

PLC: Programmable Logic Controller

D-F7□, D-J79 (With indicator light)			
Auto switch model	D-F79	D-F7P	D-J79
Wiring type	3-wire		2-wire
Output type	NPN	PNP	—
Applicable load	IC circuit, Relay, PLC		24 VDC Relay, PLC
Power supply voltage	5, 12, 24 VDC (4.5 to 28 VDC)		—
Current consumption	10 mA or less		—
Load voltage	28 VDC or less	—	24 VDC (10 to 28 VDC)
Load current	40 mA or less	80 mA or less	5 to 40 mA
Internal voltage drop	1.5 V or less (0.8 V or less at 10 mA load current)	0.8 V or less	4 V or less
Leakage current	100 μA or less at 24 VDC		0.8 mA or less at 24 VDC
Indicator light	Red LED illuminates when turned ON.		
Standard	CE marking, RoHS		

Oilproof Heavy-duty Lead Wire Specifications

Auto switch model		D-F79	D-F7P	D-J79
Sheath	Outside diameter [mm]	ø3.4		
Insulator	Number of cores	3 cores (Brown/Blue/Black)		2 cores (Brown/Blue)
	Outside diameter [mm]	ø1.1		
Conductor	Effective area [mm ²]	0.2		
	Strand diameter [mm]	ø0.08		
Minimum bending radius [mm] (Reference values)		21		

Note 1) Refer to page 436 for solid state auto switch common specifications.
Note 2) Refer to page 436 for lead wire lengths.

Weight

(g)

Auto switch model		D-F79	D-F7P	D-J79
Lead wire length	0.5 m (NII)	13		11
	3 m (L)	57		50
	5 m (Z)	92		81

Dimensions

(mm)

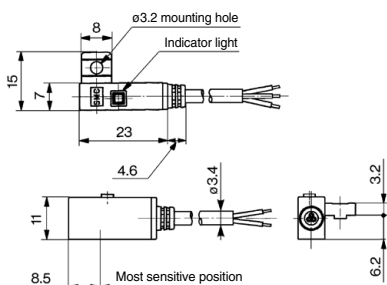

Solid State Auto Switch Rail Mounting Type

D-F7NV/D-F7PV/D-F7BV



Refer to SMC website for the details of the products conforming to the international standards.

Auto Switch Specifications

PLC: Programmable Logic Controller

D-F7□V (With indicator light)			
Auto switch model	D-F7NV	D-F7PV	D-F7BV
Wiring type	3-wire		2-wire
Output type	NPN	PNP	—
Applicable load	IC circuit, Relay, PLC		24 VDC Relay, PLC
Power supply voltage	5, 12, 24 VDC (4.5 to 28 VDC)		—
Current consumption	10 mA or less		—
Load voltage	28 VDC or less	—	24 VDC (10 to 28 VDC)
Load current	40 mA or less	80 mA or less	5 to 40 mA
Internal voltage drop	1.5 V or less (0.8 V or less at 10 mA load current)	0.8 V or less	4 V or less
Leakage current	100 μ A or less at 24 VDC		0.8 mA or less at 24 VDC
Indicator light	Red LED illuminates when turned ON.		
Standard	CE marking, RoHS		

Oilproof Heavy-duty Lead Wire Specifications

Auto switch model		D-F7NV	D-F7PV	D-F7BV
Sheath	Outside diameter [mm]	ϕ 3.4		
Insulator	Number of cores	3 cores (Brown/Blue/Black)		2 cores (Brown/Blue)
	Outside diameter [mm]	ϕ 1.1		
Conductor	Effective area [mm ²]	0.2		
	Strand diameter [mm]	ϕ 0.08		
Minimum bending radius [mm] (Reference values)		21		

Note 1) Refer to page 436 for solid state auto switch common specifications.

Note 2) Refer to page 436 for lead wire lengths.

Weight

(g)

Auto switch model		D-F7NV	D-F7PV	D-F7BV
Lead wire length	0.5 m (NII)	13	—	11
	3 m (L)	57	—	50
	5 m (Z)	92	—	81

Dimensions

(mm)

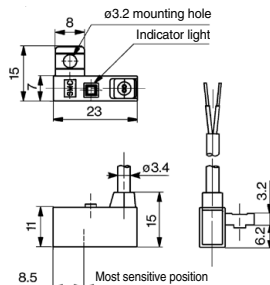

Grommet
Electrical entry: Perpendicular



CHK

CHK□

CHN

CHM

CHS□

CH2□

CHA

Related Products

D-□

Solid State Auto Switch Rail Mounting Type D-J79C



Refer to SMC website for the details of the products conforming to the international standards.

Auto Switch Specifications

PLC: Programmable Logic Controller

D-J79C (With indicator light)	
Auto switch model	D-J79C
Wiring type	2-wire
Output type	—
Applicable load	24 VDC Relay, PLC
Power supply voltage	—
Current consumption	—
Load voltage	24 VDC (10 to 28 VDC)
Load current	5 to 40 mA
Internal voltage drop	4 V or less
Leakage current	0.8 mA or less at 24 VDC
Indicator light	Red LED illuminates when turned ON.
Standard	CE marking, RoHS

Note 1) Refer to page 436 for solid state auto switch common specifications.
 Note 2) Refer to page 436 for lead wire lengths.
 Note 3) Lead wires with a connector may be shipped with auto switches.

Weight

(g)

Auto switch model		D-J79C
Lead wire length	0.5 m (NII)	13
	3 m (L)	52
	5 m (Z)	83

Dimensions

(mm)

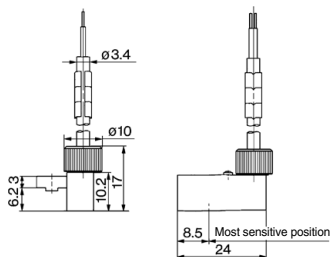
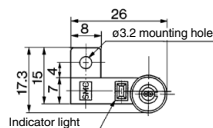

Connector

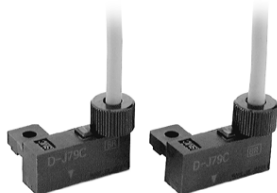

Caution

Precautions

1. Confirm that the connector is appropriately tightened. If tightened insufficiently, the waterproof performance will deteriorate.
2. Refer to Best Pneumatics No. 2-1 for the details.

Lead wires with a connector indication

Part No. of Lead Wires with Connectors (Applicable only for connector type)

Model	Lead wire length
D-LC05	0.5 m
D-LC30	3 m
D-LC50	5 m

Solid State Auto Switch Tie-rod Mounting Type D-F59/D-F5P/D-J59



Grommet



Refer to SMC website for the details of the products conforming to the international standards.

Auto Switch Specifications

PLC: Programmable Logic Controller

D-F5□, D-J59 (With indicator light)			
Auto switch model	D-F59	D-F5P	D-J59
Wiring type	3-wire		2-wire
Output type	NPN	PNP	—
Applicable load	IC circuit, Relay, PLC		24 VDC Relay, PLC
Power supply voltage	5, 12, 24 VDC (4.5 to 28 VDC)		—
Current consumption	10 mA or less		—
Load voltage	28 VDC or less	—	24 VDC (10 to 28 VDC)
Load current	40 mA or less	80 mA or less	5 to 40 mA
Internal voltage drop	1.5 V or less (0.8 V or less at 10 mA load current)	0.8 V or less	4 V or less
Leakage current	100 μA or less at 24 VDC		0.8 mA or less at 24 VDC
Indicator light	Red LED illuminates when turned ON.		
Standard	CE marking, RoHS		

CHQ

CHK□

CHN

CHM

CHS□

CHZ□

CHA

Related Products

D-□

Oilproof Heavy-duty Lead Wire Specifications

Auto switch model		D-F59	D-F5P	D-J59
Sheath	Outside diameter [mm]	ø4		
	Number of cores	3 cores (Brown/Blue/Black)	2 cores (Brown/Blue)	
Insulator	Outside diameter [mm]	ø1.22		
	Effective area [mm ²]	0.3		
Conductor	Strand diameter [mm]	ø0.08		
	Minimum bending radius [mm] (Reference values)	24		

Note 1) Refer to page 436 for solid state auto switch common specifications.

Note 2) Refer to page 436 for lead wire lengths.

Weight

(g)

Auto switch model		D-F59	D-F5P	D-J59
Lead wire length	0.5 m (NII)	23	21	21
	3 m (L)	81	71	71
	5 m (Z)	127	111	111

Dimensions

(mm)

D-F59/D-F5P/D-J59

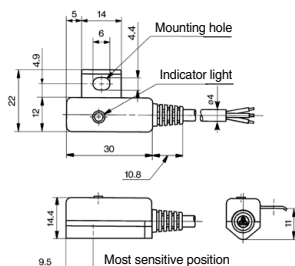

2-Color Indicator Solid State Auto Switch Direct Mounting Type

D-M9NW(V)/D-M9PW(V)/D-M9BW(V)



Refer to SMC website for the details of the products conforming to the international standards.

Grommet

- 2-wire load current is reduced (2.5 to 40 mA).
- Using flexible cable as standard spec.
- The proper operating range can be determined by the color of the light. (Red → Green ← Red)



Caution

Precautions

Fix the auto switch with the existing screw installed on the auto switch body. The auto switch may be damaged if a screw other than the one supplied is used.

Auto Switch Specifications

PLC: Programmable Logic Controller

D-M9□W, D-M9□WV (With indicator light)						
Auto switch model	D-M9NW	D-M9NWV	D-M9PW	D-M9PWV	D-M9BW	D-M9BWV
Electrical entry direction	In-line	Perpendicular	In-line	Perpendicular	In-line	Perpendicular
Wiring type	3-wire			2-wire		
Output type	NPN		PNP		—	
Applicable load	IC circuit, Relay, PLC				24 VDC relay, PLC	
Power supply voltage	5, 12, 24 VDC (4.5 to 28 V)				—	
Current consumption	10 mA or less				—	
Load voltage	28 VDC or less		—		24 VDC (10 to 28 VDC)	
Load current	40 mA or less				2.5 to 40 mA	
Internal voltage drop	0.8 V or less at 10 mA (2 V or less at 40 mA)				4 V or less	
Leakage current	100 μA or less at 24 VDC				0.8 mA or less	
Indicator light	Operating range Red LED illuminates. Proper operating range Green LED illuminates.					
Standard	CE marking, RoHS					

Oilproof Flexible Heavy-duty Lead Wire Specifications

Auto switch model		D-M9NW(V)	D-M9PW(V)	D-M9BW(V)
Sheath	Outside diameter [mm]	2.6		
Insulator	Number of cores	3 cores (Brown/Blue/Black)		2 cores (Brown/Blue)
	Outside diameter [mm]	0.88		
Conductor	Effective area [mm ²]	0.15		
	Strand diameter [mm]	0.05		
Minimum bending radius [mm] (Reference values)		17		

Note 1) Refer to page 436 for solid state auto switch common specifications.

Note 2) Refer to page 436 for lead wire lengths.

Weight

(g)

Auto switch model		D-M9NW(V)	D-M9PW(V)	D-M9BW(V)
Lead wire length	0.5 m (NII)	8	7	7
	1 m (M)	14	13	13
	3 m (L)	41	38	38
	5 m (Z)	68	63	63

Dimensions

(mm)

D-M9□W

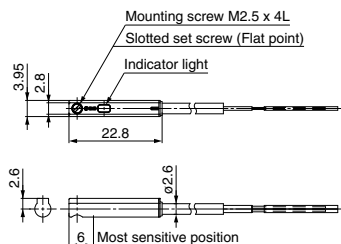

D-M9□WV

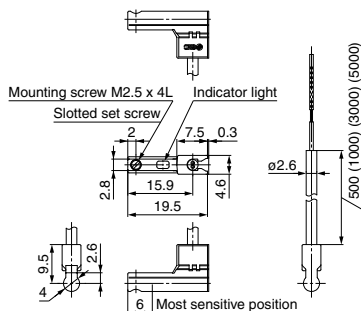

2-Color Indicator Solid State Auto Switch Direct Mounting Type

D-Y7NW(V)/D-Y7PW(V)/D-Y7BW(V)



Refer to SMC website for the details of the products conforming to the international standards.

Grommet

- The proper operating range can be determined by the color of the light. (Red → Green ← Red)
- Using flexible cable as standard spec.

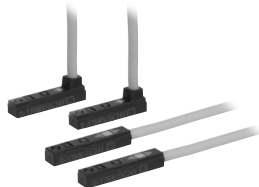

Auto Switch Specifications

PLC: Programmable Logic Controller

D-Y7□W, D-Y7□WV (With indicator light)						
Auto switch model	D-Y7NW	D-Y7NWV	D-Y7PW	D-Y7PWV	D-Y7BW	D-Y7BWV
Electrical entry direction	In-line	Perpendicular	In-line	Perpendicular	In-line	Perpendicular
Wiring type	3-wire				2-wire	
Output type	NPN		PNP		—	
Applicable load	IC circuit, Relay, PLC				24 VDC relay, PLC	
Power supply voltage	5, 12, 24 VDC (4.5 to 28 VDC)				—	
Current consumption	10 mA or less				—	
Load voltage	28 VDC or less		—		24 VDC (10 to 28 VDC)	
Load current	40 mA or less		80 mA or less		2.5 to 40 mA	
Internal voltage drop	1.5 V or less (0.8 V or less at 10 mA load current)		0.8 V or less		4 V or less	
Leakage current	100 μA or less at 24 VDC				0.8 mA or less at 24 VDC	
Indicator light	Operating range Red LED illuminates. Proper operating range Green LED illuminates.					
Standard	CE marking, RoHS					

CHK

CHK□

CHN

CHM

CHS□

CH2□

CHA

Related Products

D-□

Oilproof Flexible Heavy-duty Lead Wire Specifications

Auto switch model		D-Y7NW□	D-Y7PW□	D-Y7BW□
Sheath	Outside diameter [mm]	ø3.4		
Insulator	Number of cores	3 cores (Brown/Blue/Black)		2 cores (Brown/Blue)
	Outside diameter [mm]	ø1.0		
Conductor	Effective area [mm ²]	0.15		
	Strand diameter [mm]	ø0.05		
Minimum bending radius [mm] (Reference values)		21		

Note 1) Refer to page 436 for solid state auto switch common specifications.
Note 2) Refer to page 436 for lead wire lengths.

Weight

(g)

Auto switch model		D-Y7NW(V)	D-Y7PW(V)	D-Y7BW(V)
Lead wire length	0.5 m (Nil)	11		
	3 m (L)	54		
	5 m (Z)	88		

Dimensions

(mm)

D-Y7□W

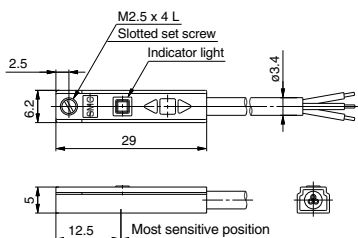

D-Y7□WV

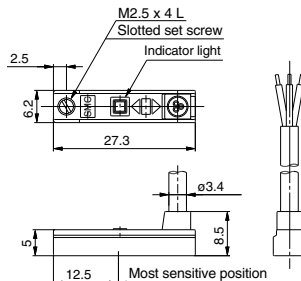

2-Color Indicator Solid State Auto Switch Band Mounting Type

D-H7NW/D-H7PW/D-H7BW



Refer to SMC website for the details of the products conforming to the international standards.

Grommet

The proper operating range can be determined by the color of the light.
(Red → Green ← Red)



Auto Switch Specifications

PLC: Programmable Logic Controller

D-H7□W (With indicator light)			
Auto switch model	D-H7NW	D-H7PW	D-H7BW
Wiring type	3-wire		2-wire
Output type	NPN	PNP	—
Applicable load	IC circuit, Relay, PLC		24 VDC relay, PLC
Power supply voltage	5, 12, 24 VDC (4.5 to 28 VDC)		—
Current consumption	10 mA or less		—
Load voltage	28 VDC or less	—	24 VDC (10 to 28 VDC)
Load current	40 mA or less	80 mA or less	5 to 40 mA
Internal voltage drop	1.5 V or less (0.8 V or less at 10 mA load current)	0.8 V or less	4 V or less
Leakage current	100 μA or less at 24 VDC		0.8 mA or less at 24 VDC
Indicator light	Operating range Red LED illuminates. Proper operating range Green LED illuminates.		
Standard	CE marking, RoHS		

Oilproof Heavy-duty Lead Wire Specifications

Auto switch model		D-H7NW	D-H7PW	D-H7BW
Sheath	Outside diameter (mm)	ø3.4		
Insulator	Number of cores	3 cores (Brown/Blue/Black)		2 cores (Brown/Blue)
	Outside diameter (mm)	ø1.1		
Conductor	Effective area (mm ²)	0.2		
	Strand diameter (mm)	ø0.08		
Minimum bending radius (mm) (Reference values)		21		

Note 1) Refer to page 436 for solid state auto switch common specifications.
Note 2) Refer to page 436 for lead wire lengths.

Weight

(g)

Auto switch model		D-H7NW	D-H7PW	D-H7BW
Lead wire length	0.5 m (NII)	13	11	11
	3 m (L)	57	50	50
	5 m (Z)	92	81	81

Dimensions

(mm)

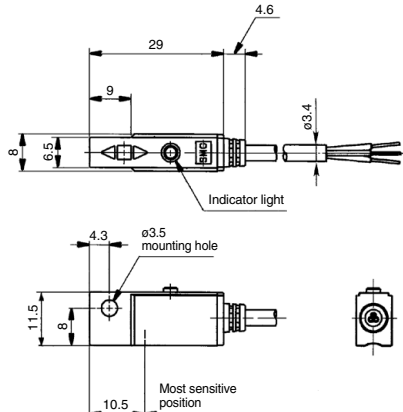

2-Color Indicator Solid State Auto Switch Band Mounting Type

D-G59W/D-G5PW/D-K59W



Refer to SMC website for the details of the products conforming to the international standards.

Grommet

The proper operating range can be determined by the color of the light.

(Red → Green ← Red)



Auto Switch Specifications

PLC: Programmable Logic Controller

D-G5□W, D-K59W (With indicator light)			
Auto switch model	D-G59W	D-G5PW	D-K59W
Wiring type	3-wire		2-wire
Output type	NPN	PNP	—
Applicable load	IC circuit, Relay, PLC		24 VDC Relay, PLC
Power supply voltage	5, 12, 24 VDC (4.5 to 28 VDC)		—
Current consumption	10 mA or less		—
Load voltage	28 VDC or less	—	24 VDC (10 to 28 VDC)
Load current	40 mA or less	80 mA or less	5 to 40 mA
Internal voltage drop	1.5 V or less (0.8 V or less at 10 mA load current)	0.8 V or less	4 V or less
Leakage current	100 μA or less at 24 VDC		0.8 mA or less at 24 VDC
Indicator light	Operating range Red LED illuminates. Proper operating range Green LED illuminates.		
Standard	CE marking, RoHS		

CHK

CHK□

CHN

CHM

CHS□

CHZ□

CHA

Related Products

D-□

Oilproof Heavy-duty Lead Wire Specifications

Auto switch model		D-G59W	D-G5PW	D-K59W
Sheath	Outside diameter [mm]	ø4		
Insulator	Number of cores	3 cores (Brown/Blue/Black)		2 cores (Brown/Blue)
	Outside diameter [mm]	ø1.22		
Conductor	Effective area [mm ²]	0.3		
	Strand diameter [mm]	ø0.08		
Minimum bending radius [mm] (Reference values)		24		

Note 1) Refer to page 436 for solid state auto switch common specifications.

Note 2) Refer to page 436 for lead wire lengths.

Weight

(g)

Auto switch model		D-G59W	D-G5PW	D-K59W
Lead wire length	0.5 m (NII)	20	—	18
	3 m (L)	78	—	68
	5 m (Z)	124	—	108

Dimensions

(mm)

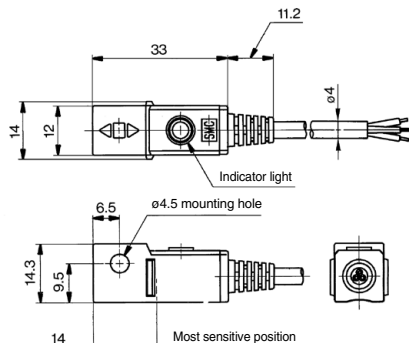

2-Color Indicator Solid State Auto Switch Rail Mounting Type D-F7NWV/D-F7BWV



Refer to SMC website for the details of the products conforming to the international standards.

PLC: Programmable Logic Controller

Auto Switch Specifications

D-F7□WV (With indicator light)		
Auto switch model	D-F7NWV	D-F7BWV
Wiring type	3-wire	2-wire
Output type	NPN	—
Applicable load	IC circuit, Relay, PLC	24 VDC Relay, PLC
Power supply voltage	5, 12, 24 VDC (4.5 to 28 VDC)	—
Current consumption	10 mA or less	—
Load voltage	28 VDC or less	24 VDC (10 to 28 VDC)
Load current	40 mA or less	5 to 40 mA
Internal voltage drop	1.5 V or less (0.8 V or less at 10 mA load current)	4 V or less
Leakage current	100 μA or less at 24 VDC	0.8 mA or less at 24 VDC
Indicator light	Operating range Red LED illuminates. Proper operating range Green LED illuminates.	
Standard	CE marking, RoHS	

Grommet
Electrical entry: Perpendicular

The proper operating range can be determined by the color of the light.
(Red → Green ← Red)

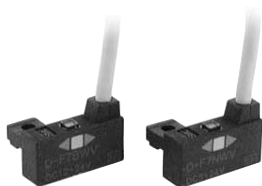

Oilproof Heavy-duty Lead Wire Specifications

Auto switch model		D-F7NWV	D-F7BWV
Sheath	Outside diameter [mm]	ø3.4	
	Number of cores	3 cores (Brown/Blue/Black)	2 cores (Brown/Blue)
Insulator	Outside diameter [mm]	ø1.1	
	Effective area [mm ²]	0.2	
Conductor	Strand diameter [mm]	ø0.08	
	Minimum bending radius [mm] (Reference values)	21	

Note 1) Refer to page 436 for solid state auto switch common specifications.
Note 2) Refer to page 436 for lead wire lengths.

Weight

(g)

Auto switch model		D-F7NWV	D-F7BWV
Lead wire length	0.5 m (NII)	13	11
	3 m (L)	57	50
	5 m (Z)	92	81

Dimensions

(mm)

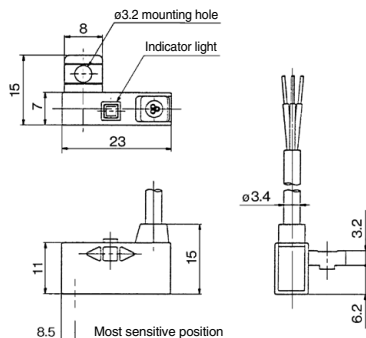

CHQ

CHK□

CHN

CHM

CHS□

CHZ□

CHA

Related Products

D-□

2-Color Indicator Solid State Auto Switch Tie-rod Mounting Type D-F59W/D-F5PW/D-J59W



Refer to SMC website for the details of the products conforming to the international standards.

Auto Switch Specifications

PLC: Programmable Logic Controller

D-F5□W, D-J59W (With indicator light)			
Auto switch model	D-F59W	D-F5PW	D-J59W
Wiring type	3-wire		2-wire
Output type	NPN	PNP	—
Applicable load	IC circuit, Relay, PLC		24 VDC Relay, PLC
Power supply voltage	5, 12, 24 VDC (4.5 to 28 VDC)		—
Current consumption	10 mA or less		—
Load voltage	28 VDC or less	—	24 VDC (10 to 28 VDC)
Load current	40 mA or less	80 mA or less	5 to 40 mA
Internal voltage drop	1.5 V or less (0.8 V or less at 10 mA load current)	0.8 V or less	4 V or less
Leakage current	100 μA or less at 24 VDC		0.8 mA or less at 24 VDC
Indicator light	Operating range Red LED illuminates. Proper operating range Green LED illuminates.		
Standard	CE marking, RoHS		

Grommet

The proper operating range can be determined by the color of the light.

(Red → Green ← Red)



Oilproof Heavy-duty Lead Wire Specifications

Auto switch model		D-F59W	D-F5PW	D-J59W
Sheath	Outside diameter [mm]	ø4		
	Number of cores	3 cores (Brown/Blue/Black)		2 cores (Brown/Blue)
Insulator	Outside diameter [mm]	ø1.22		
	Effective area [mm ²]	0.3		
Conductor	Strand diameter [mm]	ø0.08		
	Minimum bending radius [mm] (Reference values)	24		

Note 1) Refer to page 436 for solid state auto switch common specifications.

Note 2) Refer to page 436 for lead wire lengths.

Weight

(g)

Auto switch model		D-F59W	D-F5PW	D-J59W
Lead wire length	0.5 m (NII)	23		21
	3 m (L)	81		71
	5 m (Z)	127		111

Dimensions

(mm)

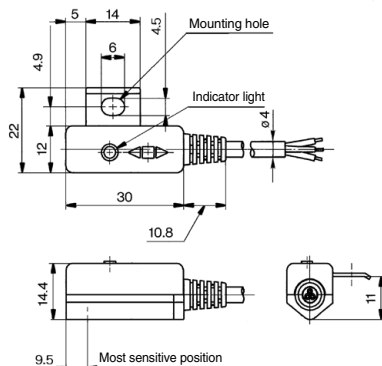

2-Color Indicator with Diagnostic Output Solid State Auto Switch: Band Mounting Type D-H7NF



Refer to SMC website for the details of the products conforming to the international standards.

Grommet

Since the diagnostic output signal can be detected in the red display area, the difference of detecting position can be confirmed by the side of PLC (Programmable Logic Controller).



PLC: Programmable Logic Controller

Auto Switch Specifications

D-H7NF (With indicator light)	
Auto switch model	D-H7NF
Wiring type	4-wire
Output type	NPN
Diagnostic output	Normal operation
Applicable load	IC circuit, Relay, PLC
Power voltage	5, 12, 24 VDC (4.5 to 28 VDC)
Current consumption	10 mA or less
Load voltage	28 VDC or less
Load current	50 mA or less at the total amount of normal output and diagnostic output
Internal voltage drop	1.5 V or less (0.8 V or less at each output 5 mA)
Current leakage	100 μ A or less at 24 VDC
Indicator light	Operating range Red LED illuminates. Proper operating range Green LED illuminates.
Standard	CE marking, RoHS

Oilproof Heavy-duty Lead Wire Specifications

Auto switch model		D-H7NF
Sheath	Outside diameter [mm]	ϕ 3.4
	Number of cores	4 cores (Brown/Blue/Black/Orange)
Insulator	Outside diameter [mm]	ϕ 0.98
	Effective area [mm ²]	0.2
Conductor	Strand diameter [mm]	ϕ 0.08
	Minimum bending radius [mm] (Reference values)	21

Note 1) Refer to page 436 for solid state auto switch common specifications.
Note 2) Refer to page 436 for lead wire lengths.

Weight

(g)

Auto switch model	D-H7NF	
Lead wire length	0.5 m (Nil)	13
	3 m (L)	56
	5 m (Z)	90

Diagnostic Output Operation

The diagnostic output signal is output within the red display area (where indicator light is Red), and the diagnostic output becomes OFF when the detecting position remains within the proper operating range (where indicator is Green). When the detecting position is not adjusted, the diagnostic output becomes ON.

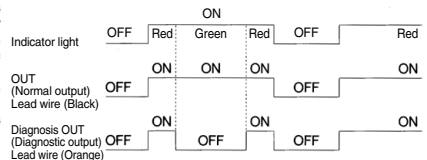

Dimensions

(mm)

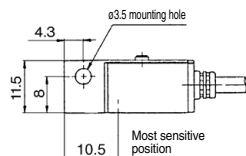
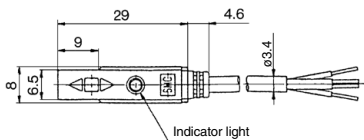

2-Color Indicator with Diagnostic Output Solid State Auto Switch: Band Mounting Type D-G59F



Refer to SMC website for the details of the products conforming to the international standards.

Grommet

Since the diagnostic output signal can be detected in the red display area, the difference of detecting position can be confirmed by the side of PLC (Programmable Logic Controller).



Auto Switch Specifications

PLC: Programmable Logic Controller

D-G59F (With indicator light)	
Auto switch model	D-G59F
Wiring type	4-wire
Output type	NPN
Diagnostic output	Normal operation
Applicable load	IC circuit, Relay, PLC
Power voltage	5, 12, 24 VDC (4.5 to 28 VDC)
Current consumption	10 mA or less
Load voltage	28 VDC or less
Load current	50 mA or less at the total amount of normal output and diagnostic output
Internal voltage drop	1.5 V or less (0.8 V or less at 5 mA)
Current leakage	100 μ A or less at 24 VDC
Indicator light	Operating range Red LED illuminates. Proper operating range Green LED illuminates.
Standard	CE marking, RoHS

Oilproof Heavy-duty Lead Wire Specifications

Auto switch model		D-G59F
Sheath	Outside diameter [mm]	$\phi 4$
	Number of cores	4 cores (Brown/Blue/Black/Orange)
Insulator	Outside diameter [mm]	$\phi 1.29$
	Effective area [mm ²]	0.3
Conductor	Strand diameter [mm]	$\phi 0.08$
	Minimum bending radius [mm] (Reference values)	24

Note 1) Refer to page 436 for solid state auto switch common specifications.
Note 2) Refer to page 436 for lead wire lengths.

Weight

(g)

Auto switch model		D-G59F
Lead wire length	0.5 m (NII)	20
	3 m (L)	74
	5 m (Z)	117

Diagnostic Output Operation

The diagnostic output signal is output within the red display area (where indicator light is Red), and the diagnostic output becomes OFF when the detecting position remains within the proper operating range (where indicator is Green). When the detecting position is not adjusted, the diagnostic output becomes ON.

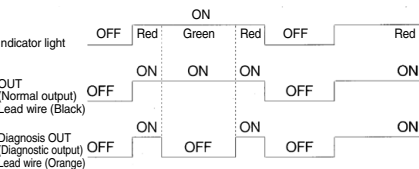

Dimensions

(mm)

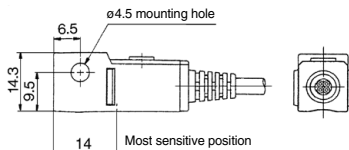
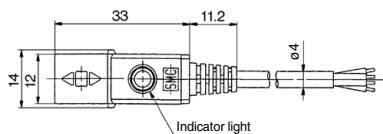

2-Color Indicator with Diagnostic Output Solid State Auto Switch: Rail Mounting Type D-F79F



Refer to SMC website for the details of the products conforming to the international standards.

Grommet

Since the diagnostic output signal can be detected in the red display area, the difference of detecting position can be confirmed by the side of PLC (Programmable Logic Controller).



Auto Switch Specifications

PLC: Programmable Logic Controller

D-F79F (With indicator light)	
Auto switch model	D-F79F
Wiring type	4-wire
Output type	NPN
Diagnostic output	Normal operation
Applicable load	IC circuit, Relay, PLC
Power supply voltage	5, 12, 24 VDC (4.5 to 28 VDC)
Current consumption	10 mA or less
Load voltage	28 VDC or less
Load current	50 mA or less at the total amount of normal output and diagnostic output
Internal voltage drop	1.5 V or less (0.8 V or less at 5 mA)
Leakage current	100 μ A or less at 24 VDC
Indicator light	Operating range Red LED illuminates. Proper operating range Green LED illuminates.
Standard	CE marking, RoHS

Oilproof Heavy-duty Lead Wire Specifications

Auto switch model		D-F79F
Sheath	Outside diameter [mm]	ϕ 3.4
Insulator	Number of cores	4 cores (Brown/Blue/Black/Orange)
	Outside diameter [mm]	ϕ 0.98
Conductor	Effective area [mm ²]	0.2
	Strand diameter [mm]	ϕ 0.08
Minimum bending radius [mm] (Reference values)		21

Note 1) Refer to page 436 for solid state auto switch common specifications.
Note 2) Refer to page 436 for lead wire lengths.

Weight

(g)

Auto switch model		D-F79F
Lead wire length	0.5 m (NII)	13
	3 m (L)	56
	5 m (Z)	90

Diagnostic Output Operation

The diagnostic output signal is output within the red display area (where indicator light is Red), and it is not output within the proper operating range (where indicator light is Green). When the auto switch detecting position is not adjusted, the diagnostic output becomes activated.

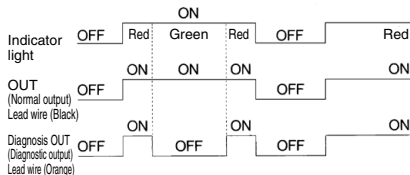

Dimensions

(mm)

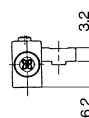
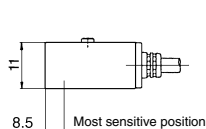
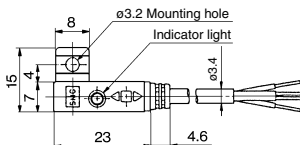

2-Color Indicator with Diagnostic Output Solid State Auto Switch: Tie-rod Mounting Type D-F59F



Refer to SMC website for the details of the products conforming to the international standards.

Grommet

Since the diagnostic output signal can be detected in the red display area, the difference of detecting position can be confirmed by the side of PLC (Programmable Logic Controller).



Auto Switch Specifications

PLC: Programmable Logic Controller

D-F59F (With indicator light)	
Auto switch model	D-F59F
Wiring type	4-wire
Output type	NPN
Diagnostic output	Normal operation
Applicable load	IC circuit, Relay, PLC
Power supply voltage	5, 12, 24 VDC (4.5 to 28 VDC)
Current consumption	10 mA or less
Load voltage	28 VDC or less
Load current	50 mA or less at the total amount of normal output and diagnostic output
Internal voltage drop	1.5 V or less (0.8 V or less at 5 mA)
Leakage current	100 μ A or less at 28 VDC
Indicator light	Operating range Red LED illuminates. Proper operating range Green LED illuminates.
Standard	CE marking, RoHS

Oilproof Heavy-duty Lead Wire Specifications

Auto switch model		D-F59F
Sheath	Outside diameter [mm]	ϕ 4
	Number of cores	4 cores (Brown/Blue/Black/Orange)
Insulator	Outside diameter [mm]	ϕ 1.29
	Effective area [mm ²]	0.3
Conductor	Strand diameter [mm]	ϕ 0.08
	Minimum bending radius [mm] (Reference values)	24

Note 1) Refer to page 436 for solid state auto switch common specifications.
Note 2) Refer to page 436 for lead wire lengths.

Weight

(g)

Auto switch model		D-F59F
Lead wire length	0.5 m (Nil)	22
	3 m (L)	77
	5 m (Z)	121

Diagnostic Output Operation

The diagnostic output signal is output within the red display area (where indicator light is Red), and it is not output within the proper operating range (where indicator light is Green). When the auto switch detecting position is not adjusted, the diagnostic output becomes activated.

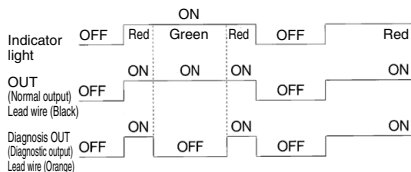

Dimensions

(mm)

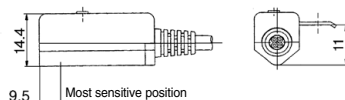
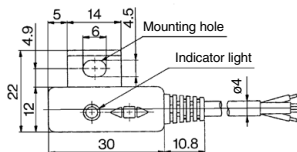

Water Resistant 2-Color Indicator Solid State Auto Switch: Direct Mounting Type

D-M9NA(V)/D-M9PA(V)/D-M9BA(V)

Grommet

- Water (coolant) resistant type
- 2-wire load current is reduced (2.5 to 40 mA).
- The proper operating range can be determined by the color of the light. (Red → Green ← Red)
- Using flexible cable as standard spec.



⚠ Caution

Precautions

Fix the auto switch with the existing screw installed on the auto switch body. The auto switch may be damaged if a screw other than the one supplied is used. Please consult with SMC if using coolant liquid other than water based solution.

Weight

(g)

Auto switch model	D-M9NA(V)	D-M9PA(V)	D-M9BA(V)
Lead wire length			
0.5 m (Nil)	8	7	
1 m (M)	14	13	
3 m (L)	41	38	
5 m (Z)	68	63	

Dimensions

(mm)

D-M9□A

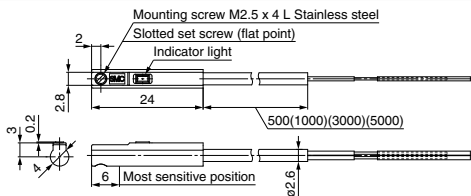

D-M9□AV

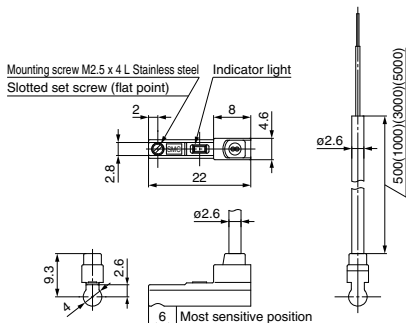

Auto Switch Specifications

PLC: Programmable Logic Controller

D-M9□A, D-M9□AV (With indicator light)						
Auto switch model	D-M9NA	D-M9NAV	D-M9PA	D-M9PAV	D-M9BA	D-M9BAV
Electrical entry direction	In-line	Perpendicular	In-line	Perpendicular	In-line	Perpendicular
Wiring type	3-wire			2-wire		
Output type	NPN		PNP		—	
Applicable load	IC circuit, Relay, PLC				24 VDC relay, PLC	
Power supply voltage	5, 12, 24 VDC (4.5 to 28 V)					—
Current consumption	10 mA or less					—
Load voltage	28 VDC or less		—		24 VDC (10 to 28 VDC)	
Load current	40 mA or less				2.5 to 40 mA	
Internal voltage drop	0.8 V or less at 10 mA (2 V or less at 40 mA)				4 V or less	
Leakage current	100 μA or less at 24 VDC				0.8 mA or less	
Indicator light	Operating range Red LED illuminates. Proper operating range Green LED illuminates.					
Standard	CE marking (EMC directive/RoHS directive)					

Oilproof Flexible Heavy-duty Lead Wire Specifications

Auto switch model		D-M9NA□	D-M9NAV□	D-M9PA□	D-M9PAV□	D-M9BA□	D-M9BAV□
Sheath	Outside diameter [mm]	2.6					
Insulator	Number of cores	3 cores (Brown/Blue/Black)				2 cores (Brown/Blue)	
	Outside diameter [mm]	0.88					
Conductor	Effective area [mm ²]	0.15					
	Strand diameter [mm]	0.05					
Minimum bending radius [mm]		17					

Note 1) Refer to page 436 for solid state auto switch common specifications.

Note 2) Refer to page 436 for lead wire lengths.

Water Resistant 2-Color Indicator Solid State Auto Switch: Direct Mounting Type D-Y7BA



Refer to SMC website for the details of the products conforming to the international standards.

Grommet

- Water (coolant) resistant type
- Using flexible cable as standard spec.
- The proper operating range can be determined by the color of the light.
(Red → Green ← Red)



Caution

Precautions

Please consult with SMC if using coolant liquid other than water based solution. Detection characteristics (operating range) are the same as D-Y5□ and D-Y7□W, but the detection area length is different.

Auto Switch Specifications

PLC: Programmable Logic Controller

D-Y7BA (With indicator light)	
Auto switch model	D-Y7BA
Wiring type	2-wire
Applicable load	24 VDC Relay, PLC
Load voltage	24 VDC (10 to 28 VDC)
Load current	2.5 to 40 mA
Internal voltage drop	4 V or less
Leakage current	0.8 mA or less at 24 VDC
Indicator light	Operating range Red LED illuminates. Proper operating range Green LED illuminates.
Standard	CE marking, RoHS

Oilproof Flexible Heavy-duty Lead Wire Specifications

Auto switch model		D-Y7BA
Sheath	Outside diameter (mm)	ø3.4
	Number of cores	2 cores (Brown/Blue)
Insulator	Outside diameter (mm)	ø1
	Effective area (mm ²)	0.15
Conductor	Strand diameter (mm)	ø0.05
	Minimum bending radius (mm) (Reference values)	21

Note 1) Refer to page 436 for solid state auto switch common specifications.

Note 2) Refer to page 436 for lead wire lengths.

Weight

(g)

Auto switch model		D-Y7BA
Lead wire length	3 m (L)	54
	5 m (Z)	88

Dimensions

(mm)

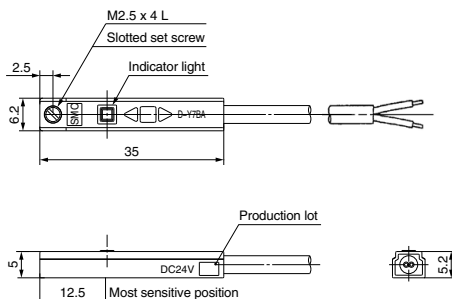

Water Resistant 2-Color Indicator Solid State Auto Switch: Band Mounting Type D-H7BA



Refer to SMC website for the details of the products conforming to the international standards.

Grommet

- Water (coolant) resistant type
- The proper operating range can be determined by the color of the light.
(Red → Green ← Red)



Caution

Precautions

Please consult with SMC if using coolant liquid other than water based solution.

Auto Switch Specifications

PLC: Programmable Logic Controller

D-H7BA (With indicator light)	
Auto switch model	D-H7BA
Wiring type	2-wire
Output type	—
Applicable load	24 VDC Relay, PLC
Power supply voltage	—
Current consumption	—
Load voltage	24 VDC (10 to 28 VDC)
Load current	5 to 40 mA
Internal voltage drop	4 V or less
Leakage current	0.8 mA or less at 24 VDC
Indicator light	Operating range Red LED illuminates. Proper operating range Green LED illuminates.
Standard	CE marking, RoHS

Oilproof Heavy-duty Lead Wire Specifications

Auto switch model		D-H7BA
Sheath	Outside diameter [mm]	ø3.4
Insulator	Number of cores	2 cores (Brown/Blue)
	Outside diameter [mm]	ø1.1
Conductor	Effective area [mm ²]	0.2
	Strand diameter [mm]	ø0.08
Minimum bending radius [mm] (Reference values)		21

Note 1) Refer to page 436 for solid state auto switch common specifications.
Note 2) Refer to page 436 for lead wire lengths.

Weight

(g)

Auto switch model		D-H7BA
Lead wire length	3 m (L)	50
	5 m (Z)	81

Dimensions

(mm)

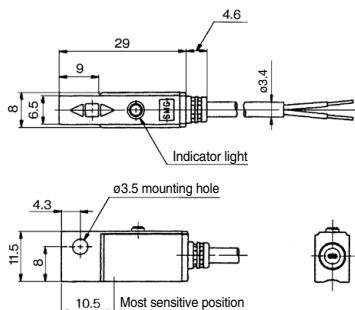

CHK

CHK

CHN

CHM

CHS

CH2

CHA

Related Products

D-

Water Resistant 2-Color Indicator Solid State Auto Switch: Band Mounting Type D-G5BA



Refer to SMC website for the details of the products conforming to the international standards.

Grommet

- Water (coolant) resistant type
- The proper operating range can be determined by the color of the light.
(Red → Green ← Red)



Caution

Precautions

Please consult with SMC if using coolant liquid other than water based solution.

Auto Switch Specifications

PLC: Programmable Logic Controller

D-G5BA (With indicator light)	
Auto switch model	D-G5BA
Wiring type	2-wire
Output type	—
Applicable load	24 VDC Relay, PLC
Power supply voltage	—
Current consumption	—
Load voltage	24 VDC (10 to 28 VDC)
Load current	5 to 40 mA
Internal voltage drop	4 V or less
Leakage current	0.8 mA or less at 24 VDC
Indicator light	Operating range Red LED illuminates. Proper operating range Green LED illuminates.
Standard	CE marking, RoHS

Oilproof Heavy-duty Lead Wire Specifications

Auto switch model		D-G5BA
Sheath	Outside diameter [mm]	ø4
	Number of cores	2 cores (Brown/Blue)
Insulator	Outside diameter [mm]	ø1.22
	Effective area [mm ²]	0.3
Conductor	Strand diameter [mm]	ø0.08
	Minimum bending radius [mm] (Reference values)	24

Note 1) Refer to page 436 for solid state auto switch common specifications.
Note 2) Refer to page 436 for lead wire lengths.

Weight

(g)

Auto switch model		D-G5BA
Lead wire length	3 m (L)	68
	5 m (Z)	108

Dimensions

(mm)

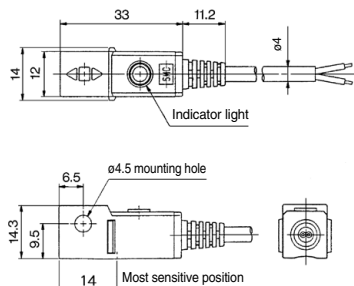

Water Resistant 2-Color Indicator Solid State Auto Switch: Rail Mounting Type D-F7BA(V)



Refer to SMC website for the details of the products conforming to the international standards.

Grommet

- Water (coolant) resistant type
- The proper operating range can be determined by the color of the light.
(Red → Green ← Red)

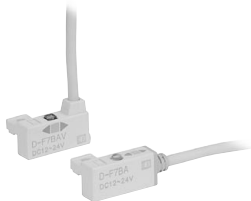

Caution

Precautions

Please consult with SMC if using coolant liquid other than water based solution.

Auto Switch Specifications

PLC: Programmable Logic Controller

D-F7BA(V) (With indicator light)		
Auto switch model	D-F7BA	D-F7BAV
Electrical entry direction	In-line	Perpendicular
Wiring type	2-wire	
Output type	—	
Applicable load	24 VDC Relay, PLC	
Power supply voltage	—	
Current consumption	—	
Load voltage	24 VDC (10 to 28 VDC)	
Load current	5 to 40 mA	
Internal voltage drop	4 V or less	
Leakage current	0.8 mA or less at 24 VDC	
Indicator light	Operating range Red LED illuminates. Proper operating range Green LED illuminates.	
Standard	CE marking, RoHS	

Oilproof Heavy-duty Lead Wire Specifications

Auto switch model		D-F7BA
Sheath	Outside diameter (mm)	ø3.4
	Number of cores	2 cores (Brown/Blue)
Insulator	Outside diameter (mm)	ø1.1
	Effective area [mm ²]	0.2
Conductor	Strand diameter (mm)	ø0.08
	Minimum bending radius (mm) (Reference values)	21

Note 1) Refer to page 436 for solid state auto switch common specifications.
Note 2) Refer to page 436 for lead wire lengths.

Weight

(g)

Auto switch model		D-F7BA	D-F7BAV
Lead wire length	3 m (L)	50	
	5 m (Z)		81

Dimensions

(mm)

D-F7BA

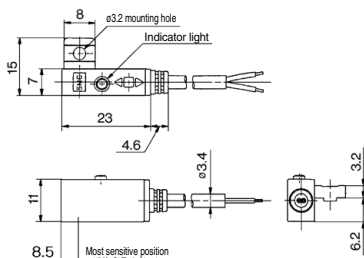

D-F7BAV

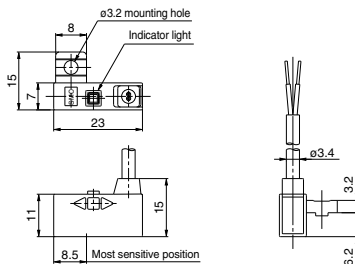

Water Resistant 2-Color Indicator Solid State Auto Switch: Tie-rod Mounting Type D-F5BA



Refer to SMC website for the details of the products conforming to the international standards.

Grommet

- Water (coolant) resistant type
- The proper operating range can be determined by the color of the light.
(Red → Green ← Red)



Caution

Precautions

Please consult with SMC if using coolant liquid other than water based solution.

Auto Switch Specifications

PLC: Programmable Logic Controller

D-F5BA (With indicator light)	
Auto switch model	D-F5BA
Wiring type	2-wire
Output type	—
Applicable load	24 VDC Relay, PLC
Power supply voltage	—
Current consumption	—
Load voltage	24 VDC (10 to 28 VDC)
Load current	5 to 40 mA
Internal voltage drop	4 V or less
Leakage current	0.8 mA or less at 24 VDC
Indicator light	Operating range Red LED illuminates. Proper operating range Green LED illuminates.
Standard	CE marking, RoHS

Oilproof Heavy-duty Lead Wire Specifications

Auto switch model		D-F5BA
Sheath	Outside diameter [mm]	ø4
Insulator	Number of cores	2 cores (Brown/Blue)
	Outside diameter [mm]	ø1.22
Conductor	Effective area [mm ²]	0.3
	Strand diameter [mm]	ø0.08
Minimum bending radius [mm] (Reference values)		24

Note 1) Refer to page 436 for solid state auto switch common specifications.
Note 2) Refer to page 436 for lead wire lengths.

Weight

(g)

Auto switch model		D-F5BA
Lead wire length	3 m (L)	71
	5 m (Z)	111

Dimensions

(mm)

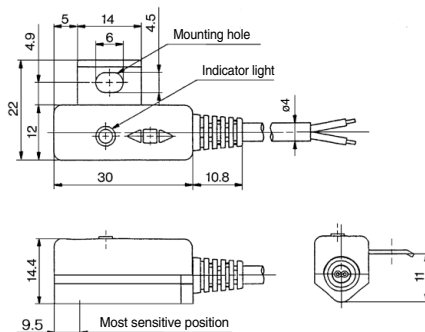

Solid State Auto Switch with Timer Band Mounting Type D-G5NT



Refer to SMC website for the details of the products conforming to the international standards.

Grommet

- With built-in OFF-delay timer (approx. 200 ms)
- Easy intermediate detection



Auto Switch Specifications

PLC: Programmable Logic Controller

D-G5NT (With indicator light)	
Auto switch model	D-G5NT
Wiring type	3-wire
Output type	NPN
Output operation	Off-delay
Operating time	1 ms or less
Off-delay time	200 ± 50 ms
Applicable load	IC circuit, Relay, PLC
Power supply voltage	5, 12, 24 VDC (4.5 to 28 VDC)
Current consumption	10 mA or less
Load voltage	28 VDC or less
Load current	40 mA or less
Internal voltage drop	1.5 V or less (0.8 V or less at 10 mA)
Leakage current	100 µA or less at 24 VDC
Indicator light	Red LED illuminates when turned ON.
Standard	CE marking, RoHS

Oilproof Heavy-duty Lead Wire Specifications

Auto switch model		D-G5NT
Sheath	Outside diameter [mm]	ø4
Insulator	Number of cores	3 cores (Brown/Blue/Black)
	Outside diameter [mm]	ø1.22
Conductor	Effective area [mm ²]	0.3
	Strand diameter [mm]	ø0.08
Minimum bending radius [mm] (Reference values)		24

Note 1) Refer to page 436 for solid state auto switch common specifications.
Note 2) Refer to page 436 for lead wire lengths.

Weight

(g)

Auto switch model	D-G5NT
Lead wire length	
3 m (L)	78
5 m (Z)	124

Timer Operation

Detection of intermediate positioning for high-speed cylinder

Detecting point dispersion occurs due to response time of PLC (sequencer); e.g. scanning.

Ex.) Cylinder speed — 1000 mm/sec.
PLC response time — 0.1 sec.
Detecting point dispersion — Within 100 mm (= 1000 mm/sec. x 0.1 sec.)

Take PLC response time into consideration when using.

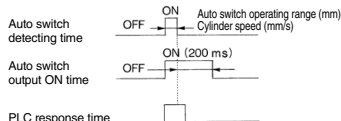

Dimensions

(mm)

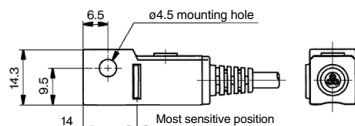
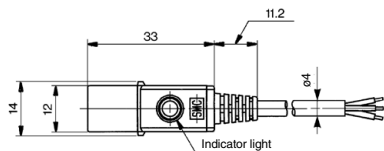

Solid State Auto Switch with Timer Rail Mounting Type D-F7NT



Refer to SMC website for the details of the products conforming to the international standards.

Grommet

- With built-in OFF-delay timer (approx. 200 ms)
- Easy intermediate detection



Auto Switch Specifications

PLC: Programmable Logic Controller

D-F7NT (With indicator light)	
Auto switch model	D-F7NT
Wiring type	3-wire
Output type	NPN
Output operation	Off-delay
Operating time	1 ms or less
Off-delay time	200 ± 50 ms
Applicable load	IC circuit, Relay, PLC
Power supply voltage	5, 12, 24 VDC (4.5 to 28 VDC)
Current consumption	10 mA or less
Load voltage	28 VDC or less
Load current	40 mA or less
Internal voltage drop	1.5 V or less (0.8 V or less at 10 mA)
Leakage current	100 µA or less at 24 VDC
Indicator light	Red LED illuminates when turned ON.
Standard	CE marking, RoHS

Oilproof Heavy-duty Lead Wire Specifications

Auto switch model		D-F7NT
Sheath	Outside diameter [mm]	ø3.4
Insulator	Number of cores	3 cores (Brown/Blue/Black)
	Outside diameter [mm]	ø1.1
Conductor	Effective area [mm ²]	0.2
	Strand diameter [mm]	ø0.08
Minimum bending radius [mm] (Reference values)		21

Note 1) Refer to page 436 for solid state auto switch common specifications.
Note 2) Refer to page 436 for lead wire lengths.

Weight

(g)

Auto switch model		D-F7NT
Lead wire length	3 m (L)	57
	5 m (Z)	92

Timer Operation

Detection of intermediate positioning for high-speed cylinder

Detecting point dispersion occurs due to response time of PLC (sequencer); e.g. scanning.

Ex.) Cylinder speed — 1000 mm/sec.
PLC response time — 0.1 sec.
Detecting point dispersion — Within 100 mm (= 1000 mm/sec. x 0.1 sec.)

Take PLC response time into consideration when using.

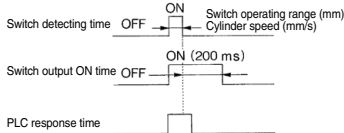

Dimensions

(mm)

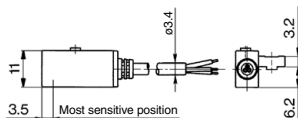
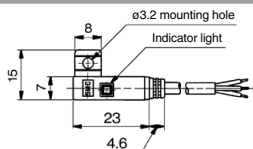

Solid State Auto Switch with Timer Tie-rod Mounting Type D-F5NT



Refer to SMC website for the details of the products conforming to the international standards.

Grommet

- With built-in OFF-delay timer (approx. 200 ms)
- Easy intermediate detection



Auto Switch Specifications

PLC: Programmable Logic Controller

D-F5NT (With indicator light)	
Auto switch model	D-F5NT
Wiring type	3-wire
Output type	NPN
Output operation	Off-delay
Operating time	1 ms or less
Off-delay time	200 ± 50 ms
Applicable load	IC circuit, Relay, PLC
Power supply voltage	5, 12, 24 VDC (4.5 to 28 VDC)
Current consumption	10 mA or less
Load voltage	28 VDC or less
Load current	40 mA or less
Internal voltage drop	1.5 V or less (0.8 V or less at 10 mA)
Leakage current	100 μA or less at 24 VDC
Indicator light	Red LED illuminates when turned ON.
Standard	CE marking, RoHS

CHK

CHK

CHN

CHM

CHS

CH2

CHA

Related Products

D-

Oilproof Heavy-duty Lead Wire Specifications

Auto switch model		D-F5NT
Sheath	Outside diameter [mm]	ø4
	Number of cores	3 cores (Brown/Blue/Black)
Insulator	Outside diameter [mm]	ø1.22
	Effective area [mm ²]	0.3
Conductor	Strand diameter [mm]	ø0.08
	Minimum bending radius [mm] (Reference values)	24

Note 1) Refer to page 436 for solid state auto switch common specifications.

Note 2) Refer to page 436 for lead wire lengths.

Timer Operation

Detection of intermediate positioning for high-speed cylinder

Detecting point dispersion occurs due to response time of PLC (sequencer); e.g. scanning.

Ex.) Cylinder speed — 1000 mm/sec.

PLC response time — 0.1 sec.

Detecting point dispersion — Within

100 mm (= 1000 mm/sec. x 0.1 sec.)

Take PLC response time into consideration when using.

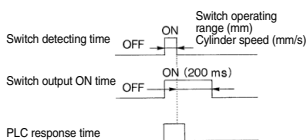

Weight

(g)

Auto switch model		D-F5NT
Lead wire length	3 m (L)	81
	5 m (Z)	127

Dimensions

(mm)

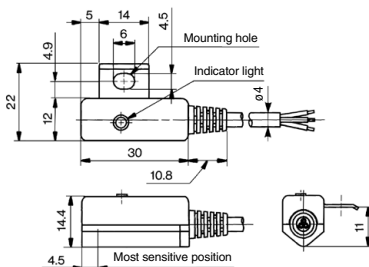

Made to Order Specifications: Solid State Auto Switch



Refer to SMC website for the details of the products conforming to the international standards.

1 With Pre-wired Connector

- Eliminates the harnessing work by cable with connector specifications
- Adopts global standardized connector (IEC947-5-2)
- IP67 construction



How to Order

D-M9N S A PC

Solid state auto switch
Standard part no.

* For the applicable auto switch model, refer to the table below.

Cable length

S	0.5 m
M	1.0 m

Connector model

A	M8-3 pin
B	M8-4 pin
D	M12-4 pin

Note) Type A is not selectable for the auto switch with diagnostic output.

Connector Specifications

Connector model	M8-3 pin	M8-4 pin	M12-4 pin
Pin arrangement			
Conformed standard	JIS C 4524, JIS C 4525, IEC 947-5-2, NECA 0402		
Impact resistance	300 m/s ²		
Enclosure	Only with screw tightened IP67 (IEC60529 standard)		
Insulation resistance	100 MΩ or more at 500 VDC measured via megohmmeter		
Withstand voltage	1500 VAC 1 minute (between contacts), Leak current 1 mA or less		

Applicable Auto Switch

For details on the D-P3DWA series magnetic field resistant auto switch, refer to the Best Pneumatics No. 2-1. And for details on the D-P4DW series, refer to the Best Pneumatics No. 2-1.

2-wire

Mounting	Function	Applicable model
Rail mounting type	—	J79, F7BV
	2-color indicator	J79W, F7BWV
	Water resistant	F7BA, F7BAV
Band mounting type	—	H7B
	—	K59
	2-color indicator	H7BW
	—	K59W
	Water resistant	H7BA
	—	G5BA
Tie-rod mounting type	—	J59
	2-color indicator	J59W
	Water resistant	F5BA
Direct mounting type	—	Y59B, Y69B
	—	M9B, M9BV
	—	F8B
	Normally closed	M9BE, M9BEV
	2-color indicator	Y7BW, Y7BWV
	—	M9BW, M9BWV
	Water resistant	Y7BA
	—	M9BA, M9BAV
	Hygienic	F6B
	Rotary actuator	—
—		T991/2, T99V1/2

3-wire

Mounting	Function	Applicable model
Rail mounting type	—	F79, F7P, F7NV, F7PV
	2-color indicator	F79W, F7PW, F7NWV
	With timer	F7NT
Band mounting type	—	H7A1, H7A2
	2-color indicator	G59, G5P
	—	H7NW, H7PW
	2-color indicator	G59W, G5PW
	With timer	G5NT
Tie-rod mounting type	—	F59, F5P
	2-color indicator	F59W, F5PW
	With timer	F5NT
Direct mounting type	—	Y59A, Y7P, Y69A, Y7PV
	—	M9N, M9P, M9NV, M9PV
	—	F8N, F8P
	—	Y7G, Y7H
	—	F9G, F9H
	Normally closed	M9NE, M9PE, M9NEV, M9PEV
	2-color indicator	Y7NW, Y7PW, Y7NWV, Y7PWV
	—	M9NW, M9PW, M9NWV, M9PWV
	Water resistant	M9NA, M9NAV, M9PA, M9PAV
	Hygienic	F6N, F6P
Rotary actuator	—	S791/2, S7P1/2
	—	S991/2, S9P1/2, S99V1/2

4-wire

Mounting	Function	Applicable model
Rail mounting type	Direct mounting type	F79F
Band mounting type		H7NF
Tie-rod mounting type		G59F
		F59F

Note) M8-3 pins are not selectable for the 4-wire auto switch.

Connector pin arrangement

Sensor type	Meaning of contact number			
	1 pin	2 pin	3 pin	4 pin
2-wire	OUT(+)	—	—	OUT(-)
3-wire	DC(+)	—	DC(-)	OUT
4-wire	DC(+)	Diagnostic output	DC(-)	OUT

Note1) For details on the D-P3DWASC and D-P3DWASE, refer to page 1630. And for details on the D-P4DWSC and D-P4DWSE, refer to page 1634.

Note2) For details on the pin arrangement, refer to the pin arrangement in the connector specifications above.

With Pre-wired Connector

Dimensions



M8-3 pin
4 pin



M8-4 pin



M12-4 pin

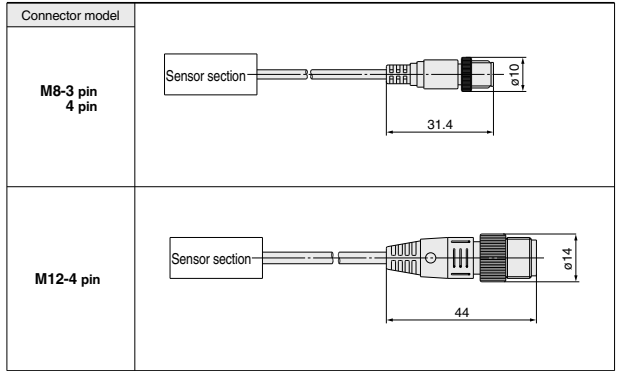

Connection (Female side) Connector Cable

As the parts are not supplied from SMC, refer to the application examples listed in the below.
(For detail such as catalog availability, etc., please contact each manufacturer.)

Connector size	Number of pins	Manufacturer	Applicable series example
M8	3	Phoenix Contact	SAC-3P
		Corrence Corporation	M8-3D
		OMFROM Corporation	M8-4D
M12	4	Phoenix Contact	XS3
		Corrence Corporation	SAC-4P
		OMFROM Corporation	VA-4D
		Azbil Corp.	XS2
		HIROSE ELECTRIC CO., LTD.	PA5-4I
	DDK Ltd.	HR24	
		DDK Ltd.	CM01-8DP4S

Weight for Connector Type

Part no.	Connector type	Weight
D-□□□APC	M8-3 pin	4 g
D-□□□BPC	M8-4 pin	4 g
D-□□□DPC	M12-4 pin	About 11 g

CHQ

CHK

CHN

CHM

CHS

CH2

CHA

Related Products

D-□

Made to Order Specifications: Solid State Auto Switch

-50: Without Indicator Light (Dark room) Specifications

-61: Oilproof Flexible Heavy-duty Cord Specifications

2 Without Indicator Light (for dark room specifications)

Symbol
-50

Possible to use under the environment which hates a light.

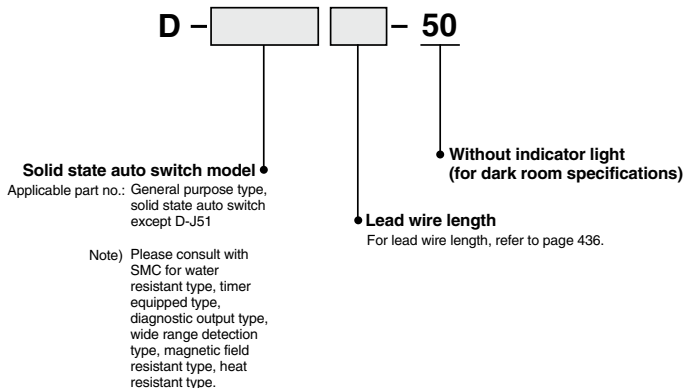

Dimensions and specifications are common as standard products with the exception of no indicator light.

3 Oilproof Flexible Heavy-duty Cord Specifications

Symbol
-61

This is the product which uses a heavy-duty cord having flexible characteristics 5 times (SMC comparison) as strong as oilproof heavy-duty cord used in the standard products.

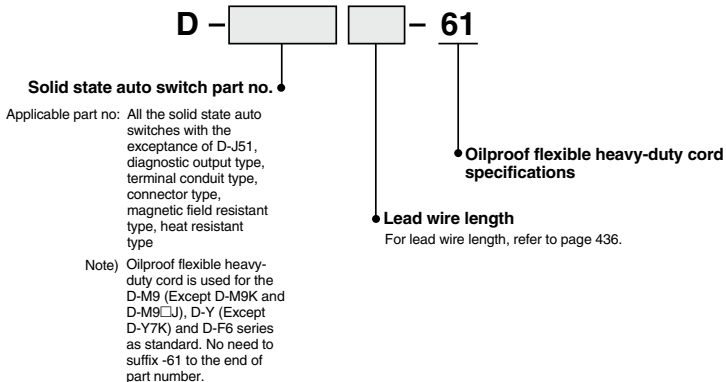

Specifications are the same as standard products with the exception of lead wire specifications.

Lead wire: For D-F8 type..... ø2.7, 0.15 mm², 3 cores (Brown, Blue, Black), 2 cores (Brown, Blue)
For other model nos..... ø3.4, 0.15 mm², 3 cores (Brown, Blue, Black), 2 cores (Brown, Blue)

Dimensions are identical with D-F5 type, G5 type, J59 type, K59 type. Lead wire diameter is changed from ø4 to ø3.4. In other series products, it is common as standard product's specifications.

Reed Auto Switches

General Purpose Type,
2-Color Indication Type

Reed Switch Variations

Type	Function	Auto switch mounting type	Electrical entry	Auto switch model	Page
Reed Auto Switch	General purpose	Direct	Grommet	D-A90/A93/A96*	478
				D-A90V/A93V/A96V*	
		Band	Grommet	D-Z73/Z76/Z80**	487
				D-C73/C76/C80	479
			Connector	D-B53/B54/B64	480
				D-C73C/C80C	481
				D-A33/A34	482
				D-A44	482
		Rail	Grommet	D-A72/A73/A80	483
				D-A72H/A73H/A76H/A80H	484
	Tie-rod	Connector	D-A73C/A80C	485	
			D-A53/A54/A56/A64/A67	486	
	2-color indicator	Band	Grommet	D-B59W	488
				D-A79W	489
D-A59W				490	

* Auto switches with an asterisk (*) can be mounted on a band (excluding D-A9□V), rail, tie-rod or square groove with an auto switch mounting bracket. For details, refer to "How to Mount and Move the Auto Switch" of each series.

** This auto switch can be mounted by tie-rod with using auto switch mounting bracket. For details, refer to "How to Mount and Move the Auto Switch" of each series.

CHQ

CHK

CHN

CHM

CHS

CH2

CHA

Related Products

D-

Reed Auto Switch Direct Mounting Type

D-A90(V)/D-A93(V)/D-A96(V) (C) (E)

Refer to SMC website for the details of the products conforming to the international standards.

Auto Switch Specifications

PLC: Programmable Logic Controller

Grommet

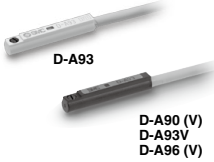

Caution

Precautions

- Do not drop or bump the auto switch while handling it as it may result in the auto switch breaking.
- Do not remove the protective cover attached to the product body until the product is ready to be mounted on the actuator.
- Fix the auto switch with the existing screw installed on the auto switch body. The auto switch may be damaged if a screw other than the one supplied is used.

D-A90, D-A90V (Without indicator light)			
Auto switch model	D-A90, D-A90V		
Applicable load	IC circuit, Relay, PLC		
Load voltage	24 V $\frac{DC}{AC}$ or less	48 V $\frac{DC}{AC}$ or less	100 V $\frac{DC}{AC}$ or less
Maximum load current	50 mA	40 mA	20 mA
Internal circuit*	④		
Contact protection circuit	None		
Internal resistance	1 Ω or less (Including lead wire length of 3 m)		
Standard	CE marking		
D-A93, D-A93V, D-A96, D-A96V (With indicator light)			
Auto switch model	D-A93, D-A93V	D-A96, D-A96V	
Applicable load	Relay, PLC	IC circuit	
Load voltage	24 VDC ⁽⁴⁾	100 VAC	4 to 8 VDC
Load current range and Maximum load current ⁽³⁾	5 to 40 mA	5 to 20 mA	20 mA
Internal circuit*	③		⑤
Contact protection circuit	None		
Internal voltage drop	D-A93: 2.4 V or less (up to 20 mA)/3 V or less (up to 40 mA) D-A93V: 2.7 V or less		0.8 V or less
Indicator light	Red LED illuminates when turned ON.		
Standard	CE marking		

Oilproof Heavy-duty Lead Wire Specifications

Auto switch model	D-A90(V)	D-A93(V)	D-A96(V)
Sheath	Outside diameter [mm] $\phi 2.7$		
Insulator	Number of cores		3 cores (Brown/Blue/Black)
	Outside diameter [mm]		$\phi 0.91$
Conductor	Effective area [mm ²]		0.18
	Strand diameter [mm]		$\phi 0.08$
Lead wire minimum bending radius [mm] (Reference values)			17

* Refer to the applicable internal circuit diagram (numbers ① to ⑦) on page 439.

Note 1) Refer to page 436 for reed auto switch common specifications.

Note 2) Refer to page 436 for lead wire lengths.

Note 3) Under 5 mA, the strength of the indicator light is poor. In some cases, visibility of the indicator light will not be possible where the output signal is less than 2.5 mA. However, there is no problem in terms of contact output, when an output signal exceeds 1 mA or more.

Note 4) The auto switches can operate at 12 VDC, but consider the internal voltage drop of the auto switch described in Reed Auto Switch Precautions on page 221.

Weight

(g)

Model	D-A90	D-A90V	D-A93	D-A93V	D-A96	D-A96V
Lead wire length	0.5 m (NII)	6	6	6	6	8
	1 m (M)	—	—	11	—	—
	3 m (L)	30	30	30	30	41
	5 m (Z)	—	—	47	47	—

Dimensions

(mm)

D-A90/D-A93/D-A96

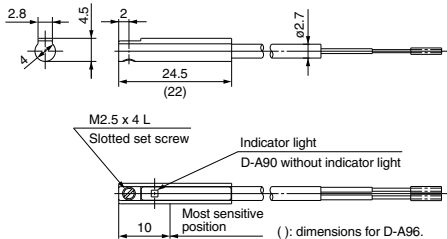

D-A90V/D-A93V/D-A96V

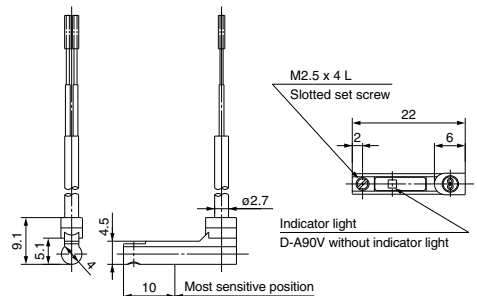

Reed Auto Switch Band Mounting Type D-C73/D-C76/D-C80



Refer to SMC website for the details of the products conforming to the international standards.

Grommet



Caution

Precautions

Do not drop or bump the auto switch while handling it as it may result in the auto switch breaking.

Auto Switch Specifications

PLC: Programmable Logic Controller

D-C7 (With indicator light)			
Auto switch model	D-C73		D-C76
Applicable load	Relay, PLC		IC circuit
Load voltage	24 VDC ⁽⁴⁾	100 VAC	4 to 8 VDC
Max. load current and range ⁽³⁾	5 to 40 mA	5 to 20 mA	20 mA
Internal circuit [*]	③		⑤
Contact protection circuit	None		
Internal voltage drop	2.4 V or less		0.8 V or less
Indicator light	Red LED illuminates when turned ON.		
Standard	CE marking		
D-C8 (Without indicator light)			
Auto switch model	D-C80		
Applicable load	Relay, PLC, IC circuit		
Load voltage	24 V $\frac{AC}{DC}$ or less	48 V $\frac{AC}{DC}$	100 V $\frac{AC}{DC}$
Max. load current	50 mA	40 mA	20 mA
Internal circuit [*]	④		
Contact protection circuit	None		
Internal resistance	1 Ω or less (Including lead wire length of 3 m)		
Standard	CE marking		

Oilproof Heavy-duty Lead Wire Specifications

Auto switch model		D-C73	D-C76	D-C80
Sheath	Outside diameter (mm)	$\phi 3.4$		
Insulator	Number of cores	2 cores (Brown/Blue)	3 cores (Brown/Blue/Black)	2 cores (Brown/Blue)
	Outside diameter (mm)	$\phi 1.1$		
Conductor	Effective area (mm ²)	0.2		
	Strand diameter (mm)	$\phi 0.08$		
Lead wire minimum bending radius (mm) (Reference values)		21		

* Refer to the applicable internal circuit diagram (numbers ① to ⑦) on page 439.

Note 1) Refer to page 436 for reed auto switch common specifications.

Note 2) Refer to page 436 for lead wire lengths.

Note 3) Under 5 mA, the strength of the indicator light is poor. In some cases, visibility of the indicator light will not be possible where the output signal is less than 2.5 mA. However, there is no problem in terms of contact output, when an output signal exceeds 1 mA or more.

Note 4) The auto switches can operate at 12 VDC, but consider the internal voltage drop of the auto switch described in Reed Auto Switch Precautions on page 221.

Weight

(g)

Auto switch model		D-C73	D-C76	D-C80
Lead wire length	0.5 m (Nil)	9	10	9
	3 m (L)	46	50	46
	5 m (Z)	76	—	—

Dimensions

(mm)

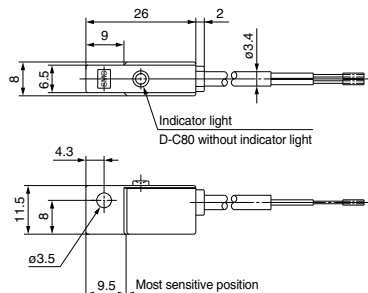

Reed Auto Switch Band Mounting Type D-B53/D-B54/D-B64



Refer to SMC website for the details of the products conforming to the international standards.

Grommet



Caution

Precautions

Do not drop or bump the auto switch while handling it as it may result in the auto switch breaking.

Auto Switch Specifications

PLC: Programmable Logic Controller

D-B5 (With indicator light)			
Auto switch model	D-B53		D-B54
Applicable load	PLC		Relay, PLC
Load voltage	24 VDC ⁽⁴⁾	24 VDC ⁽⁴⁾	100 VAC 200 VAC
Load current range ⁽³⁾	5 to 50 mA	5 to 50 mA	5 to 25 mA 5 to 12.5 mA
Internal circuit*	③		①
Contact protection circuit	None		Built-in
Internal voltage drop	2.4 V or less	2.4 V or less (Up to 20 mA)/3.5 V or less (Up to 50 mA)	
Indicator light	Red LED illuminates when turned ON.		
Standard	CE marking		
D-B6 (Without indicator light)			
Auto switch model	D-B64		
Applicable load	Relay, PLC		
Load voltage	24 V ^{AC} or less	100 VAC	200 VAC
Max. load current	Max. 50 mA	Max. 25 mA	Max. 12.5 mA
Internal circuit*	②		
Contact protection circuit	Built-in		
Internal resistance	25 Ω or less		
Standard	CE marking		

Oilproof Heavy-duty Lead Wire Specifications

Auto switch model		D-B53/B54/B64	
Sheath	Outside diameter (mm)	ø4	
	Number of cores	2 cores (Brown/Blue)	
Insulator	Outside diameter (mm)	ø1.22	
	Effective area (mm ²)	0.3	
Conductor	Strand diameter (mm)	ø0.08	
	Lead wire minimum bending radius (mm) (Reference values)	24	

* Refer to the applicable internal circuit diagram (numbers ① to ⑦) on page 439.

Note 1) Refer to page 436 for reed auto switch common specifications.

Note 2) Refer to page 436 for lead wire lengths.

Note 3) Under 5 mA, the strength of the indicator light is poor. In some cases, visibility of the indicator light will not be possible where the output signal is less than 2.5 mA. However, there is no problem in terms of contact output, when an output signal exceeds 1 mA or more.

Note 4) The auto switches can operate at 12 VDC, but consider the internal voltage drop of the auto switch described in Reed Auto Switch Precautions on page 221.

Weight

(g)

Auto switch model		D-B53	D-B54	D-B64
Lead wire length	0.5 m (Nil)	22	22	22
	3 m (L)	78	78	78
	5 m (Z)	126	126	—

Dimensions

(mm)

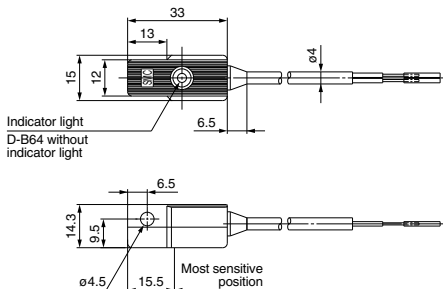

Reed Auto Switch Band Mounting Type D-C73C/D-C80C



Refer to SMC website for the details of the products conforming to the international standards.

Connector



Caution

Precautions

1. Do not drop or bump the auto switch while handling it as it may result in the auto switch breaking.
2. Confirm that the connector is appropriately tightened. If tightened insufficiently, the waterproof performance will deteriorate.
3. For details, refer to Best Pneumatics No. 2-1.

Auto Switch Specifications

PLC: Programmable Logic Controller

D-C73C (With indicator light)	
Auto switch model	D-C73C
Applicable load	Relay, PLC
Load voltage	24 VDC ⁽⁵⁾
Load current range ⁽⁴⁾	5 to 40 mA
Internal circuit [*]	③
Contact protection circuit	None
Internal voltage drop	2.4 V or less
Indicator light	Red LED illuminates when turned ON.
Standard	CE marking
D-C80C (Without indicator light)	
Auto switch model	D-C80C
Applicable load	Relay, PLC
Load voltage	24 V ^{AC} _{DC} or less
Maximum load current	50 mA
Internal circuit [*]	④
Contact protection circuit	None
Internal resistance	1 Ω or less (Including lead wire length of 3 m)
Standard	CE marking

* Refer to the applicable internal circuit diagram (numbers ① to ⑦) on page 439.

Note 1) Refer to page 436 for reed auto switch common specifications.

Note 2) Refer to page 436 for lead wire lengths.

Note 3) Lead wire with connector may be shipped with switch.

Note 4) Under 5 mA, the strength of the indicator light is poor. In some cases, visibility of the indicator light will not be possible where the output signal is less than 2.5 mA. However, there is no problem in terms of contact output, when an output signal exceeds 1 mA or more.

Note 5) The auto switches can operate at 12 VDC, but consider the internal voltage drop of the auto switch described in Reed Auto Switch Precautions on page 221.

Weight

(g)

Auto switch model	D-C73C	D-C80C
Lead wire length		
0.5 m (NII)	14	14
3 m (L)	53	53
5 m (Z)	83	83

Lead wires with a connector indication

Part No. of Lead Wires with Connectors
(Applicable only for connector type)

Model	Lead wire length
D-LC05	0.5 m
D-LC30	3 m
D-LC50	5 m

Dimensions

(mm)

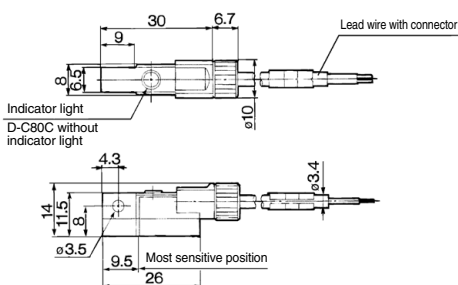

Reed Auto Switch Band Mounting Type D-A33/D-A34/D-A44



Refer to SMC website for the details of the products conforming to the international standards.

Terminal conduit: D-A3
DIN terminal: D-A4



⚠ Caution

Precautions

1. Do not drop or bump the auto switch while handling it as it may result in the auto switch breaking.
2. Use cable whose O.D. is within the size in the figure to maintain water resistant performance.
3. After wiring, confirm that tightening gland and all screws are tightened.

Auto Switch Specifications

PLC: Programmable Logic Controller

D-A3 (With indicator light) Terminal conduit				
Auto switch model	D-A33		D-A34	
Applicable load	PLC		Relay, PLC	
Load voltage	24 VDC ⁽³⁾	24 VDC ⁽³⁾	100 VAC	200 VAC
Load current range ⁽²⁾	5 to 50 mA	5 to 50 mA	5 to 25 mA	5 to 12.5 mA
Internal circuit [*]	③		①	
Contact protection circuit	None		Built-in	
Internal voltage drop	2.4 V or less	2.4 V or less (Up to 20 mA)/3.5 V or less (Up to 50 mA)		
Indicator light	Red LED illuminates when turned ON.			
Standard	CE marking			
D-A44 (With indicator light) DIN terminal				
Auto switch model	D-A44			
Applicable load	Relay, PLC			
Load voltage	24 VDC ⁽³⁾	100 VAC	200 VAC	
Load current range	5 to 50 mA	5 to 25 mA	5 to 12.5 mA	
Internal circuit [*]	①			
Contact protection circuit	Built-in			
Internal voltage drop	2.4 V or less (Up to 20 mA)/3.5 V or less (Up to 50 mA)			
Indicator light	Red LED illuminates when turned ON.			
Standard	CE marking			

* Refer to the applicable internal circuit diagram (numbers ① to ⑦) on page 439.

Note 1) Refer to page 436 for reed auto switch common specifications.

Note 2) Under 5 mA, the strength of the indicator light is poor. In some cases, visibility of the indicator light will not be possible where the output signal is less than 2.5 mA. However, there is no problem in terms of contact output, when an output signal exceeds 1 mA or more.

Note 3) The auto switches can operate at 12 VDC, but consider the internal voltage drop of the auto switch described in Reed Auto Switch Precautions on page 221.

Weight

(g)

Auto switch model		D-A33	D-A34	D-A44
Lead wire	None	116	116	114

Dimensions

(mm)

D-A3

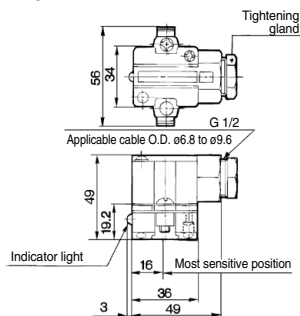

D-A44

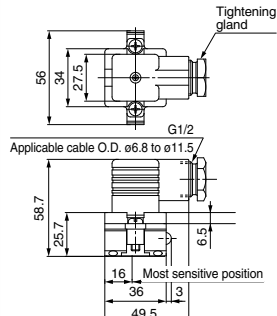

Reed Auto Switch Rail Mounting Type D-A72/D-A73/D-A80



Refer to SMC website for the details of the products conforming to the international standards.

Grommet
Electrical entry: Perpendicular



Caution

Precautions

Do not drop or bump the auto switch while handling it as it may result in the auto switch breaking.

Auto Switch Specifications

PLC: Programmable Logic Controller

D-A7 (With indicator light)			
Auto switch model	D-A72	D-A73	
Applicable load	Relay, PLC	Relay, PLC	
Load voltage	200 VAC	24 VDC ⁽⁴⁾	100 VAC
Load current range ⁽³⁾	5 to 10 mA	5 to 40 mA	5 to 20 mA
Internal circuit*	③		
Contact protection circuit	None		
Internal voltage drop	2.4 V or less		
Indicator light	Red LED illuminates when turned ON.		
Standard	CE marking		
D-A8 (Without indicator light)			
Auto switch model	D-A80		
Applicable load	Relay, IC circuit, PLC		
Load voltage	24 V ^{AC} or less	48 V ^{DC}	100 V ^{AC}
Maximum load current	50 mA	40 mA	20 mA
Internal circuit*	④		
Contact protection circuit	None		
Internal resistance	1 Ω or less (Including lead wire length of 3 m)		
Standard	CE marking		

Oilproof Heavy-duty Lead Wire Specifications

Auto switch model		D-A72	D-A73	D-A80
Sheath	Outside diameter [mm]	ø3.4		
Insulator	Number of cores	2 cores (Brown/Blue)		
	Outside diameter [mm]	ø1.1		
Conductor	Effective area [mm ²]	0.2		
	Strand diameter [mm]	ø0.08		
Lead wire minimum bending radius [mm] (Reference values)		21		

* Refer to the applicable internal circuit diagram (numbers ① to ⑦) on page 439.

Note 1) Refer to page 436 for reed auto switch common specifications.

Note 2) Refer to page 436 for lead wire lengths.

Note 3) Under 5 mA, the strength of the indicator light is poor. In some cases, visibility of the indicator light will not be possible where the output signal is less than 2.5 mA. However, there is no problem in terms of contact output, when an output signal exceeds 1 mA or more.

Note 4) The auto switches can operate at 12 VDC, but consider the internal voltage drop of the auto switch described in Reed Auto Switch Precautions on page 221.

Weight

(g)

Auto switch model		D-A72	D-A73	D-A80
Lead wire length	0.5 m (NII)	10	10	10
	3 m (L)	47	47	47
	5 m (Z)	—	77	—

Dimensions

(mm)

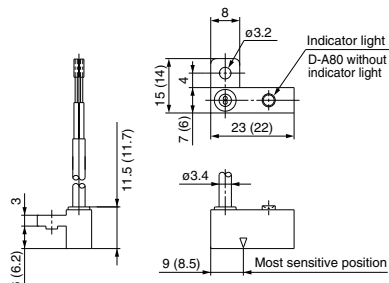

() values for D-A72



Reed Auto Switch Rail Mounting Type D-A7□H/D-A80H



**Grommet
Electrical entry: In-line**



⚠ Caution

Precautions

Do not drop or bump the auto switch while handling it as it may result in the auto switch breaking.

Auto Switch Specifications

Refer to SMC website for the details of the products conforming to the international standards.

PLC: Programmable Logic Controller

D-A7□H (With indicator light)			
Auto switch model	D-A72H	D-A73H	D-A76H
Applicable load	Relay, PLC	Relay, PLC	IC circuit
Load voltage	200 VAC	24 VDC ⁽⁴⁾ 100 VAC	4 to 8 VDC
Max. load current/Load current range ⁽³⁾	5 to 10 mA	5 to 40 mA 5 to 20 mA	20 mA
Internal circuit*	③		⑤
Contact protection circuit	None		
Internal voltage drop	2.4 V or less		0.8 V or less
Indicator light	Red LED illuminates when turned ON.		
Standard	CE marking		
D-A80H (Without indicator light)			
Auto switch model	D-A80H		
Applicable load	Relay, IC circuit, PLC		
Load voltage	24 V ^{AC} _{DC} or less	48 V ^{DC} _{DC}	100 V ^{AC} _{DC}
Maximum load current	50 mA	40 mA	20mA
Internal circuit*	④		
Contact protection circuit	None		
Internal resistance	1 Ω or less (Including lead wire length of 3 m)		
Standard	CE marking		

Oilproof Heavy-duty Lead Wire Specifications

Auto switch model		D-A72H/A73H	D-A76H	D-A80H
Sheath	Outside diameter [mm]	ø3.4		
Insulator	Number of cores	2 cores (Brown/Blue)	3 cores (Brown/Blue/Black)	2 cores (Brown/Blue)
	Outside diameter [mm]	ø1.1		
Conductor	Effective area [mm ²]	0.2		
	Strand diameter [mm]	ø0.08		
Lead wire minimum bending radius [mm] (Reference values)		21		

* Refer to the applicable internal circuit diagram (numbers ① to ⑦) on page 439.

Note 1) Refer to page 436 for reed auto switch common specifications.

Note 2) Refer to page 436 for lead wire lengths.

Note 3) Under 5 mA, the strength of the indicator light is poor. In some cases, visibility of the indicator light will not be possible where the output signal is less than 2.5 mA. However, there is no problem in terms of contact output, when an output signal exceeds 1 mA or more.

Note 4) The auto switches can operate at 12 VDC, but consider the internal voltage drop of the auto switch described in Reed Auto Switch Precautions on page 221.

Weight

(g)

Auto switch model		D-A72H	D-A73H	D-A76H	D-A80H
Lead wire length	0.5 m (Nil)	10	10	11	10
	3 m (L)	47	47	52	47
	5 m (Z)	—	77	—	—

Dimensions

(mm)

D-A7□H, D-A80H

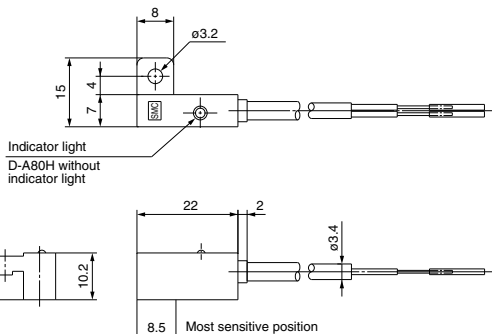

Reed Auto Switch Rail Mounting Type D-A73C/D-A80C



Refer to SMC website for the details of the products conforming to the international standards.

Connector



Caution

Precautions

1. Do not drop or bump the auto switch while handling it as it may result in the auto switch breaking.
2. Confirm that the connector is appropriately tightened. If tightened insufficiently, the waterproof performance will deteriorate.
3. Refer to Best Pneumatics No. 2-1 for the details.

Auto Switch Specifications

PLC: Programmable Logic Controller

D-A73C (With indicator light)	
Auto switch model	D-A73C
Applicable load	Relay, PLC
Load voltage	24 VDC ⁽⁵⁾
Load current range ⁽⁴⁾	5 to 40 mA
Internal circuit*	③
Contact protection circuit	None
Internal voltage drop	2.4 V or less
Indicator light	Red LED illuminates when turned ON.
Standard	CE marking
D-A80C (Without indicator light)	
Auto switch model	D-A80C
Applicable load	Relay, IC circuit, PLC
Load voltage	24 V ^{AC} _{DC}
Maximum load current	50 mA
Internal circuit*	④
Contact protection circuit	None
Internal resistance	1 Ω or less (Including lead wire length of 3 m)
Standard	CE marking

* Refer to the applicable internal circuit diagram (numbers ① to ⑦) on page 439.

Note 1) Refer to page 436 for reed auto switch common specifications.

Note 2) Refer to page 436 for lead wire lengths.

Note 3) Lead wire with connector may be shipped with the auto switch.

Note 4) Under 5 mA, the strength of the indicator light is poor. In some cases, visibility of the indicator light will not be possible where the output signal is less than 2.5 mA. However, there is no problem in terms of contact output, when an output signal exceeds 1 mA or more.

Note 5) The auto switches can operate at 12 VDC, but consider the internal voltage drop of the auto switch described in Reed Auto Switch Precautions on page 221.

Weight

(g)

Auto switch model		D-A73C	D-A80C
Lead wire length	0.5 m (Nil)	12	12
	3 m (L)	54	54
	5 m (Z)	84	84

Dimensions

(mm)

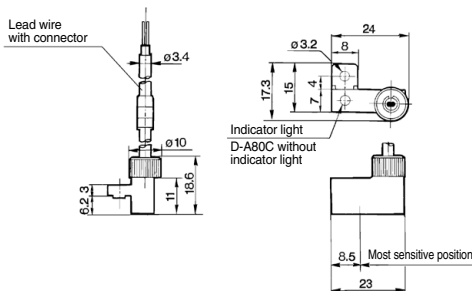

Lead wires with a connector indication

Part No. of Lead Wires with Connectors
(Applicable only for connector type)

Model	Lead wire length
D-LC05	0.5 m
D-LC30	3 m
D-LC50	5 m

Reed Auto Switch Tie-rod Mounting Type D-A5□/□/ D-A6□/□



Grommet



⚠ Caution

Precautions

Do not drop or bump the auto switch while handling it as it may result in the auto switch breaking.

Auto Switch Specifications

Refer to SMC website for the details of the products conforming to the international standards.

PLC: Programmable Logic Controller

D-A5 (With indicator light)					
Auto switch model	D-A53	D-A54		D-A56	
Applicable load	PLC	Relay, PLC		IC circuit	
Load voltage	24 VDC (4)	24 VDC (4)	100 VAC	200 VAC	4 to 8 VDC
Maximum load (3) current and range	5 to 50 mA	5 to 50 mA	5 to 25 mA	5 to 12.5 mA	20 mA
Internal circuit*	③	①		⑤	
Contact protection circuit	None	Built-in		None	
Internal voltage drop	2.4 V or less	2.4 V or less (Up to 20 mA)/3.5 V or less (Up to 50 mA)		0.8 V or less	
Indicator light	Red LED illuminates when turned ON.				
Standard	CE marking				
D-A6 (Without indicator light)					
Auto switch model	D-A64			D-A67	
Applicable load	Relay, PLC			PLC/IC circuit	
Load voltage	24 V ^{AC} _{DC} or less	100 VAC	200 VAC	Max. 24 VDC	
Maximum load current	50 mA	25 mA	12.5 mA	30 mA	
Internal circuit*	②			④	
Contact protection circuit	Built-in			None	
Internal resistance	25 Ω or less			1 Ω or less (Including lead wire length of 3 m)	
Standard	CE marking				

Oilproof Heavy-duty Lead Wire Specifications

Auto switch model		D-A53/A54	D-A56	D-A64/A67
Sheath	Outside diameter [mm]	ø4		
Insulator	Number of cores	2 cores (Brown/Blue)	3 cores (Brown/Blue/Black)	2 cores (Brown/Blue)
	Outside diameter [mm]	ø1.22		
Conductor	Effective area [mm ²]	0.3	0.2	0.3
	Strand diameter [mm]	ø0.08		
Lead wire minimum bending radius [mm] (Reference value)		24		

* Refer to the applicable internal circuit diagram (numbers ① to ⑦) on page 439.

Note 1) Refer to page 436 for reed auto switch common specifications.

Note 2) Refer to page 436 for lead wire lengths.

Note 3) Under 5 mA, the strength of the indicator light is poor. In some cases, visibility of the indicator light will not be possible where the output signal is less than 2.5 mA. However, there is no problem in terms of contact output, when an output signal exceeds 1 mA or more.

Note 4) The auto switches can operate at 12 VDC, but consider the internal voltage drop of the auto switch described in Reed Auto Switch Precautions on page 221.

Weight

(g)

Auto switch model		D-A53	D-A54	D-A56	D-A64	D-A67
Lead wire length	0.5 m (NII)	24	—	24	—	24
	3 m (L)	80	—	80	—	80
	5 m (Z)	125	—	—	—	—

Dimensions

(mm)

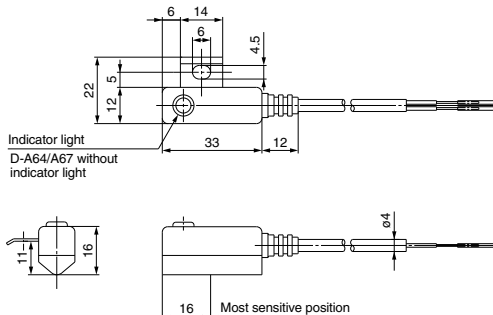

Reed Auto Switch Direct Mounting Type D-Z73/D-Z76/D-Z80



Refer to SMC website for the details of the products conforming to the international standards.

Auto Switch Specifications

PLC: Programmable Logic Controller

D-Z7 (With indicator light)			
Auto switch model	D-Z73		D-Z76
Applicable load	Relay, PLC		
Load voltage	24 VDC ⁽⁴⁾	100 VAC	IC circuit
Max. load current and load current range ⁽³⁾	5 to 40 mA	5 to 20 mA	4 to 8 VDC
Internal circuit*	③		⑤
Contact protection circuit	None		
Internal voltage drop	2.4 V or less (Up to 20 mA)/3 V or less (Up to 40 mA)	0.8 V or less	
Indicator light	Red LED illuminates when turned ON.		
Standard	CE marking		
D-Z8 (Without indicator light)			
Auto switch model	D-Z80		
Applicable load	Relay, PLC, IC circuit		
Load voltage	24 V ^{AC} _{DC} or less	48 V ^{AC} _{DC}	100 V ^{AC} _{DC}
Maximum load current	50 mA	40 mA	20 mA
Internal circuit*	④		
Contact protection circuit	None		
Internal resistance	1 Ω or less (Including 3 m lead wire)		
Standard	CE marking		



Grommet

Caution

Precautions

- Do not drop or bump the auto switch while handling it as it may result in the auto switch breaking.
- Do not remove the protective cover attached to the product body until the product is ready to be mounted on the actuator.
- Fix the auto switch with the existing screw installed on the auto switch body. The auto switch may be damaged if a screw other than the one supplied is used.

- CHK
- CHK
- CHN
- CHM
- CHS
- CHZ
- CHA
- Related Products
- D-

Oilproof Heavy-duty Lead Wire Specifications

Auto switch model		D-Z73	D-Z76	D-Z80
Sheath	Outside diameter [mm]	ø2.7	ø3.4	ø2.7
	Number of cores	2 cores (Brown/Blue)	3 cores (Brown/Blue/Black)	2 cores (Brown/Blue)
Insulator	Outside diameter [mm]	ø1.1		
	Effective area [mm ²]	0.18	0.2	0.18
Conductor	Strand diameter [mm]	ø0.08		
	Lead wire minimum bending radius [mm] (Reference values)	17	21	17

* Refer to the applicable internal circuit diagram (numbers ① to ⑦) on page 439.

Note 1) Refer to page 436 for reed auto switch common specifications.

Note 2) Refer to page 436 for lead wire lengths.

Note 3) Under 5 mA, the strength of the indicator light is poor. In some cases, visibility of the indicator light will not be possible where the output signal is less than 2.5 mA. However, there is no problem in terms of contact output, when an output signal exceeds 1 mA or more.

Note 4) The auto switches can operate at 12 VDC, but consider the internal voltage drop of the auto switch described in Reed Auto Switch Precautions on page 221.

Weight

(g)

Auto switch model		D-Z73	D-Z76	D-Z80
Lead wire length	0.5 m (NII)	7	10	7
	3 m (L)	31	55	31
	5 m (Z)	50	—	—

Dimensions

(mm)

D-Z73, Z80

D-Z76

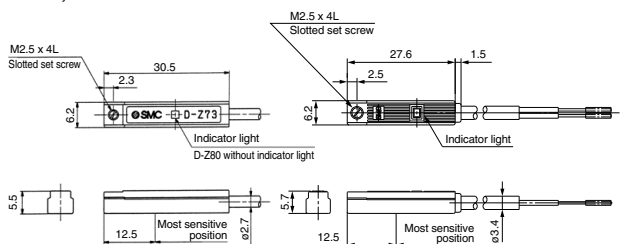

2-Color Indicator Reed Auto Switch Band Mounting Type D-B59W



Grommet

The proper operating range can be determined by the color of the light.
(Red → Green ← Red)



Caution

Precautions

Do not drop or bump the auto switch while handling it as it may result in the auto switch breaking.

Auto Switch Specifications

Refer to SMC website for the details of the products conforming to the international standards.

PLC: Programmable Logic Controller

D-B59W (With indicator light)	
Auto switch model	D-B59W
Applicable load	Relay, PLC
Load voltage	24 VDC
Load current range ⁽³⁾	5 to 40 mA
Internal circuit*	⑥
Contact protection circuit	Built-in
Internal voltage drop	4 V or less
Indicator light	Operating range Red LED illuminates. Proper operating range Green LED illuminates.
Standard	CE marking

Oilproof Heavy-duty Lead Wire Specifications

Auto switch model		D-B59W
Sheath	Outside diameter [mm]	ø4
	Number of cores	2 cores (Brown/Blue)
Insulator	Outside diameter [mm]	ø1.22
	Effective area [mm ²]	0.3
Conductor	Strand diameter [mm]	ø0.08
	Lead wire minimum bending radius [mm] (Reference values)	24

* Refer to the applicable internal circuit diagram (numbers ① to ⑦) on page 439.

Note 1) Refer to page 436 for reed auto switch common specifications.

Note 2) Refer to page 436 for lead wire lengths.

Note 3) Under 5 mA, the strength of the indicator light is poor. In some cases, visibility of the indicator light will not be possible where the output signal is less than 2.5 mA. However, there is no problem in terms of contact output, when an output signal exceeds 1 mA or more.

Weight

(g)

Auto switch model		D-B59W
Lead wire length	0.5 m (NII)	20
	3 m (L)	76

Dimensions

(mm)

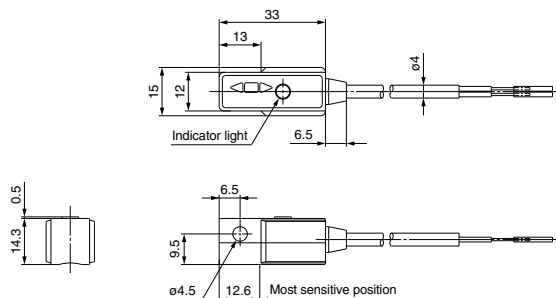

2-Color Indicator Reed Auto Switch Rail Mounting Type D-A79W



Grommet

The proper operating range can be determined by the color of the light.
(Red → Green ← Red)



Caution

Precautions

Do not drop or bump the auto switch while handling it as it may result in the auto switch breaking.

Auto Switch Specifications

Refer to SMC website for the details of the products conforming to the international standards.

PLC: Programmable Logic Controller

D-A79W (With indicator light)	
Auto switch model	D-A79W
Applicable load	Relay, PLC
Load voltage	24 VDC
Load current range ⁽³⁾	5 to 40 mA
Internal circuit*	⑦
Contact protection circuit	None
Internal voltage drop	4 V or less
Indicator light	Operating range Red LED illuminates. Proper operating range Green LED illuminates.
Standard	CE marking

Oilproof Heavy-duty Lead Wire Specifications

Auto switch model		D-A79W
Sheath	Outside diameter [mm]	ø3.4
	Number of cores	2 cores (Brown/Blue)
Insulator	Outside diameter [mm]	ø1.1
	Effective area [mm ²]	0.2
Conductor	Strand diameter [mm]	ø0.08
	Lead wire minimum bending radius [mm] (Reference values)	21

* Refer to the applicable internal circuit diagram (numbers ① to ⑦) on page 439.

Note 1) Refer to page 436 for reed auto switch common specifications.

Note 2) Refer to page 436 for lead wire lengths.

Note 3) Under 5 mA, the strength of the indicator light is poor. In some cases, visibility of the indicator light will not be possible where the output signal is less than 2.5 mA. However, there is no problem in terms of contact output, when an output signal exceeds 1 mA or more.

Weight

(g)

Auto switch model		D-A79W
Lead wire length	0.5 m (NII)	11
	3 m (L)	53

Dimensions

(mm)

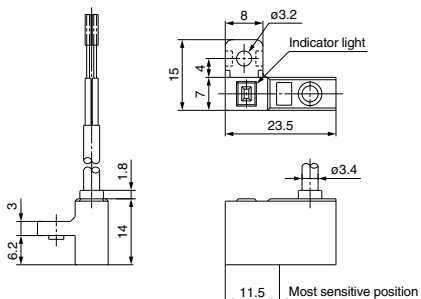

2-Color Indicator Reed Auto Switch Tie-rod Mounting Type D-A59W



Grommet

The proper operating range can be determined by the color of the light.

(Red → Green ← Red)



Caution

Precautions

Do not drop or bump the auto switch while handling it as it may result in the auto switch breaking.

Auto Switch Specifications

Refer to SMC website for the details of the products conforming to the international standards.

PLC: Programmable Logic Controller

D-A59W (With indicator light)	
Auto switch model	D-A59W
Applicable load	Relay, PLC
Load voltage	24 VDC
Load current range ⁽³⁾	5 to 40 mA
Internal circuit*	⑥
Contact protection circuit	Built-in
Internal voltage drop	4 V or less
Indicator light	Operating range Red LED illuminates. Proper operating range Green LED illuminates.
Standard	CE marking

Oilproof Heavy-duty Lead Wire Specifications

Auto switch model		D-A59W
Sheath	Outside diameter [mm]	ø4
	Number of cores	2 cores (Brown/Blue)
Insulator	Outside diameter [mm]	ø1.22
	Effective area [mm ²]	0.3
Conductor	Strand diameter [mm]	ø0.08
	Lead wire minimum bending radius [mm] (Reference values)	24

* Refer to the applicable internal circuit diagram (numbers ① to ⑦) on page 439.

Note 1) Refer to page 436 for reed auto switch common specifications.

Note 2) Refer to page 436 for lead wire lengths.

Note 3) Under 5 mA, the strength of the indicator light is poor. In some cases, visibility of the indicator light will not be possible where the output signal is less than 2.5 mA. However, there is no problem in terms of contact output, when an output signal exceeds 1 mA or more.

Weight

(g)

Auto switch model		D-A59W
Lead wire length	0.5 m (NII)	25
	3 m (L)	80

Dimensions

(mm)

