

Magnetic Separator FHM Series



These magnetic separators protect machinery from malfunctions, reduced precision, and burnout by adsorbing and eliminating contaminants in the fluid by means of magnetism. This helps extend the service life of hydraulic equipment.

Zero running cost

Since there are no consumable parts, the running cost is basically zero and the magnetic separator can be used semi-permanently.

Extends service life of hydraulic fluid

By adsorbing and eliminating contaminants, the magnetic separator retards deterioration of the hydraulic fluid and makes it possible to extend the fluid replacement time.

Reduced maintenance costs

The magnetic separator prevents mechanical problems caused by contaminants such as abrasive particles and greatly reduces maintenance costs.



Specifications

	FHMN	FHM
Fluid	Petroleum, Water-glycol, Cutting oil, Emulsion	Petroleum, Water-glycol, Cutting oil, Emulsion, Phosphoric ester
Operating temperature	Max. 80°C	Max. 150°C
Fluid speed	3 m/min or less	

Model

Model	Applicable fluid storage volume (L/unit) ^{Note)}	Dimension (mm)	Weight (kg)
FHMN-055	20	□55 x t20	0.2
FHM-100	100	□100 x t30	0.9
FHM-200	200	200 x 140 x t40	2.5

Note) For example, three FHM100 magnetic separator units would be sufficient for a 300-liter fluid storage tank.

Contaminant density of 200 ppm

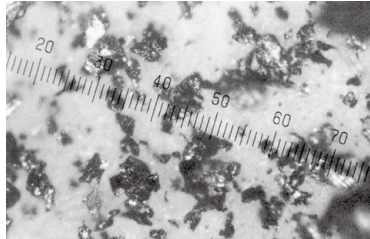

Separator after contaminant adsorption

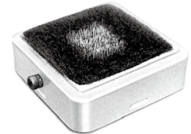

Fluid after cleaning with magnetic separator (5 ppm)

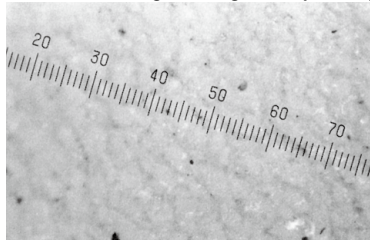

Magnetic Separator Installation Examples

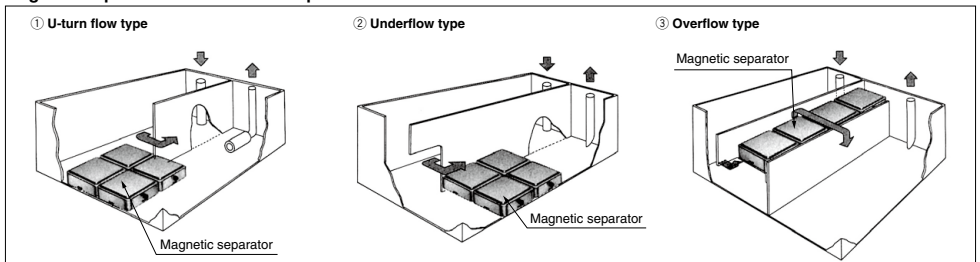

How to Order

FHMN-055

• Magnetic separator

• Main unit representative dimensions

055 □55 x t20

FHM-100

• Magnetic separator

• Main unit representative dimensions

100 □100 x t30
200 200 x 140 x t40

Fluid Iron Content Elimination Performance by Iron Particle Concentration

FHMN-055

Fluid: Hydraulic fluid

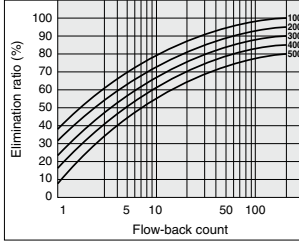

FHM-100

Fluid: Hydraulic fluid

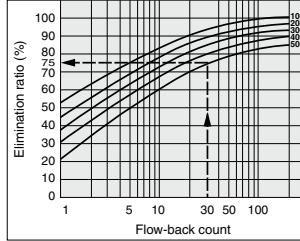

FHM-200

Fluid: Hydraulic fluid

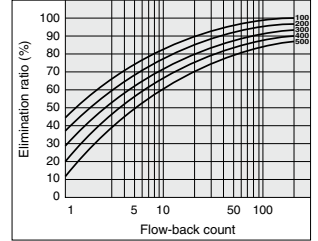

Explanation of graph

Example: Elimination ratio and concentration after using the FHM-100 for one hour under the following conditions.

- Conditions
1. Volume of fluid in tank: 200 L
 2. Pump-out volume: 100 L/min
 3. Contaminant concentration of used fluid: 500 ppm (initial concentration, percentage by volume)
 4. Number of separators: 2 pcs. (applicable fluid storage volume of 100 L/unit)

Explanation of graph

① Calculate the flow-back count (N).

$$N = \frac{\text{Pump-out volume} \times \text{Operation time}}{\text{Volume of fluid in tank}} = \frac{100 \times 60}{200} = 30$$

② Based on the elimination ratio data for the FHM-100 and the point where the 500 ppm line and flow-back count 30 line intersect (one hour after starting operation), the result is 75%.

Construction

FHMN-055

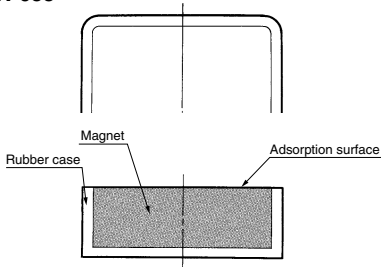

FHM-100

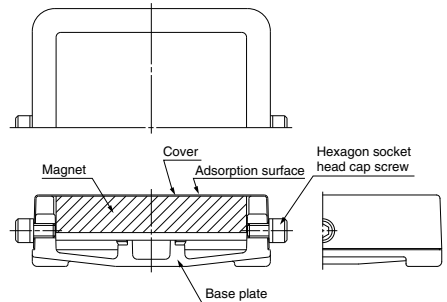

FHM-200

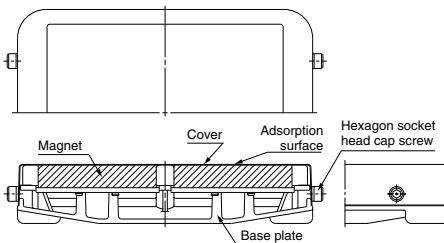

Dimensions

FHMN-055

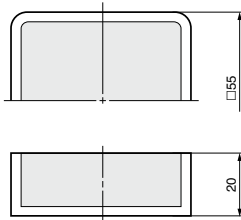

FHM-100

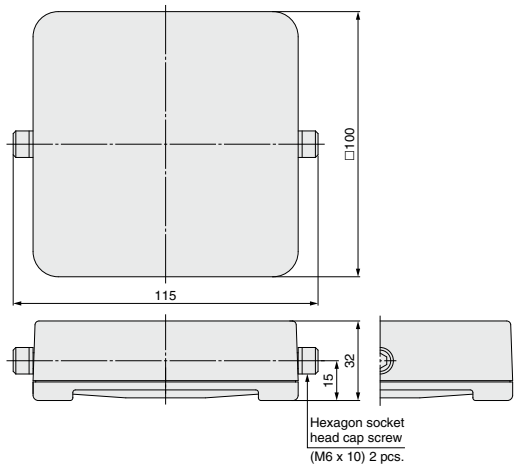

FHM-200

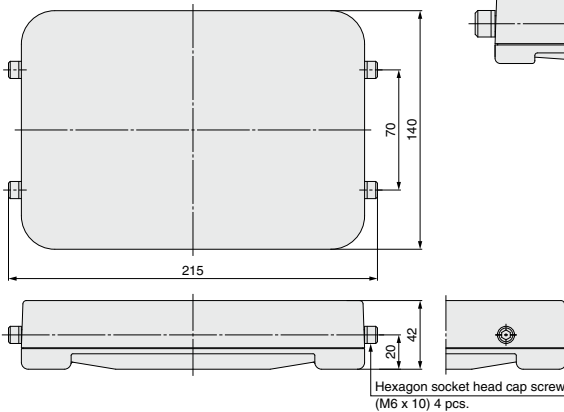

FH□

HOW□

Handling Precautions

Mounting

- ① The flat portion of the stainless steel cover functions as the contaminant adsorption surface. However, for FHM□-055, the flat portion of the magnetic material functions as the contaminant adsorption surface.
- ② Mount the magnetic separator in a location where fluid is constantly flowing by in laminar flow.
- ③ Avoid locations such as near the suction pipe or return pipe, places where there is turbulence, and locations where the flow speed is 3 m/min or greater.

- ④ If necessary, fix the separator in place. If frequent cleaning will be necessary, it can be suspended from the top panel of the tank.
- ⑤ If a fluid switch (built-in lead switch) or the like is used, it should be installed in a location where it will not be affected by magnetism from the separator. (Refer to the technical data sheet (FGX-TD-T011) for information on magnetic fields.)

Maintenance

- ① Clean the separator regularly. Make sure to clean it once the accumulation of contaminants reaches a thickness of 20 mm or so.
- ② Clean the adsorption surface of the separator by wiping away the accumulated contaminants using a soft rag or the like.

Handling

- ① Do not bring the top surface of the separator near magnetically attractive objects such as iron plates.
- ② Handle the separators individually and do not bring them into close proximity with each other.
- ③ Be careful not to get your fingers caught between the product and iron plate, etc., when installing the separator.
- ④ Do not bring objects that are affected by magnetism (electronic equipment, magnetic cards, watches, etc.) close to the separator.
- ⑤ When transporting this product by air freight, the product must be packaged so that the magnetic flux density becomes below the predetermined specified value. Confirm with the International Air Transport Association (IATA) or the Aviation Laws of each country.

Example of handle equipped type

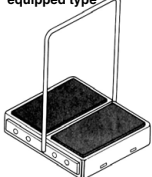

Example of cover/handle equipped type

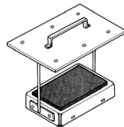

Example of tank fixed type

