

Standards-based cylinders DSBG to ISO 15552



Standards-based cylinders DSBG to ISO 15552

Key features

FESTO

At a glance



DIN



- Standards-based cylinders to ISO 15552 (corresponds to the withdrawn standards ISO 6431, DIN ISO 6431, VDMA 24 562, NF E 49 003.1 and UNI 10290)

- Sturdy tie rod design
- Double-acting
- For contactless position sensing
- Available with protection against rotation
- EX4: for use in potentially explosive areas
- Extensive range of accessories makes it possible to install the cylinder virtually anywhere
- Three types of cushioning available:
 - P cushioning: elastic cushioning rings/pads at both ends
 - PPS cushioning: pneumatic cushioning, self-adjusting at both ends
 - PPV cushioning: pneumatic cushioning, adjustable at both ends
- The variants can be configured according to individual needs using a modular product system
- High flexibility thanks to the wide range of variants

DSBG-...-P2 – With bellows kit DADB, to ISO 15552

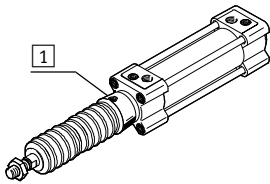

The bellows kit is a leak-free system. To prevent unwanted media from being drawn in, the supply and exhaust air must be ducted via a pressure compensation hole in the connection

part **1**. The kit protects the piston rod, seal and bearings against a wide variety of media, for example:

- Dust
- Chippings
- Oil
- Grease
- Fuel

Ordering the bellows kit

An extended piston rod is absolutely essential if a bellows kit is to be used. The bellows kit can be ordered via the modular product system or as an accessory. The following must be noted in this case:

Ordering via the modular product system:

The bellows kit is supplied mounted on the bearing cap using feature P2. The required piston rod extension is automatically taken into consideration. This means that there is no need to specify a value for feature ...E.

Ordering as an accessory:

If the bellows kit is ordered as an accessory, the required value **→ 39** must be entered for feature ...E in the modular product system.

Position sensing/force control

With position sensor SMAT-8M, SMAT-8E, SDAT **→ 43**



- Analogue position feedback possible
- Analogue output
 - 0 ... 10 V
 - 0 ... 20 mA















With proportional pressure regulator VPPM

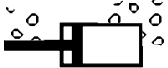

- Infinite adjustment of the gripping force possible
- Setpoint input
 - 0 ... 10 V
 - 4 ... 20 mA

Standards-based cylinders DSBG, to ISO 15552

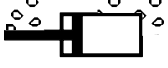
Key features

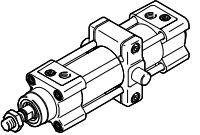
Variants from the modular product system		
Symbol	Key features	Description
	Q Square piston rod	Protection against rotation. For correctly oriented feeding
	L Low friction	At high piston speeds, considerably greater efficiency than other versions. The special materials considerably reduce system wear. Low-friction movements are therefore possible, especially during rapid stroke movements. Seal contains silicone grease
	U Uniform, slow movement	Low break-away pressure, suitable for slow stroke movements at a constant, judder-free speed over the full stroke range. Seal contains silicone grease
	L1 Low friction for balancer applications	At low piston speeds, low-friction operation is achieved in both directions. Special geometry of the seal enables virtually identical running characteristics regardless of the operating pressure. Additionally with low break-away pressure. Not suitable for applications with transverse loading on the piston rod
	T Through piston rod	For working at both ends with the same force in the forward and return stroke, for attaching external stops
	F Female piston rod thread	–
	R3 High corrosion protection	All external cylinder surfaces comply with corrosion resistance class 3 to Festo standard 940 070. The piston rod is made from corrosion and acid-resistant steel
	T1 Heat-resistant seals	Temperature range 0 ... +120 °C
	T3 Low temperature	Temperature range –40 ... +80 °C
	T4 Heat-resistant seals	Temperature range 0 ... +150 °C
	A2 Scrapper variant	Hard scrapper: The cylinder is equipped with a hard-chrome plated piston rod and a hard scrapper, which protects against dry, dusty and viscous media
	A3 Scrapper variant	Unlubricated operation: Cleaning processes degrease the piston rod. A special piston rod seal designed for unlubricated operation permits a longer service life compared to the standard seal
	A6 Scrapper variant	Metal scrapper The cylinder is fitted with a hard-chrome plated piston rod and metal scrapper, which scrapes off hard particles (e.g. welding spatter) sticking to the piston rod. For use in welding systems, for example
	...E Piston rod extension	–
	...L Piston rod thread extension	–
	...V Swivel mounting position	<ul style="list-style-type: none"> • Swivel mounting, position freely selectable • Position can be moved at any time

Standards-based cylinders DSBG, to ISO 15552

Product range overview

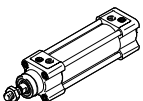
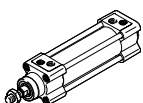
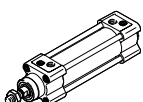
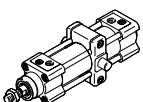
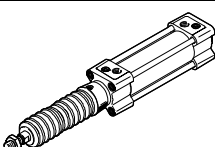
Function	Design	Type	Piston Ø	Stroke	Through piston rod	Female piston rod thread	Cushioning			
			[mm]	[mm]						T
Double-acting	DSBG-...									
		DSBG-...	32, 40, 50, 63, 80, 100, 125	1 ... 2800		■	■	■	■	■
	DSBG-...-Q – With protection against rotation									
		DSBG-...-Q	32, 40, 50, 63, 80, 100	1 ... 1500		■	■	■	■	■
	DSBG-...-L/-U/-L1 – With special running characteristics									
		DSBG-...-L	32, 40, 50, 63, 80, 100	1 ... 2800	-	■	■	■	■	■
		DSBG-...-U	32, 40, 50, 63, 80, 100, 125	1 ... 2800	-	■	■	■	■	■
		DSBG-...-L1	32, 40, 50, 63, 80, 100, 125	10 ... 1000	-	■	■	■	■	-
	DSBG-...-...V – With swivel mounting position									
		DSBG-...-...V	32, 40, 50, 63, 80, 100, 125	10 ... 2800		■	■	■	■	■
DSBG-...-P2 – With bellows										
	DSBG-...-P2	32, 40, 50, 63, 80, 100	10 ... 500		■	■	■	■	■	

Standards-based cylinders DSBG, to ISO 15552

Product range overview

Type	Position sensing	High corrosion protection	Temperature range 0 ... +120 °C	Temperature range -40 ... +80 °C	Temperature range 0 ... +150 °C	Scraper variant hard scraper (ring)	Scraper variant for unlubricated operation	Scraper variant metal scraper	EU certification	Piston rod extension	Piston rod thread extension
	A	R3	T1	T3	T4	A2	A3	A6	EX4	...E	...L
DSBG-...											
DSBG-...	■	■	■	■	■	■	■	■	■	■	■
DSBG-...-Q – With protection against rotation											
DSBG-...-Q	■	■	■	-	-	-	-	-	■	■	■
DSBG-...-L/-U/-L1 – With special running characteristics											
DSBG-...-L	■	-	-	-	-	-	-	-	-	■	■
DSBG-...-U	■	-	-	-	-	-	-	-	-	■	■
DSBG-...-L1	■	-	-	-	-	-	-	-	-	■	■
DSBG-...-V – With swivel mounting position											
DSBG-...-V	■	-	■	■	■	■	■	■	■	■	■
DSBG-...-P2 – With bellows											
DSBG-...-P2	■	■	-	-	-	-	-	-	-	■	■

Standards-based cylinders DSBG, to ISO 15552

Type codes

		DSBG	-		-		-	32	-	50	-		-		-	PPV	-	A	
Type																			
Double-acting																			
DSBG	Standards-based cylinder																		
Protection against rotation																			
-	Without protection against rotation																		
Q	With protection against rotation																		
Running characteristics																			
-	Standard																		
L	Low friction																		
U	Constant, slow movement																		
L1	Low friction for balancer applications																		
Piston Ø [mm]																			
Stroke [mm]																			
Piston rod																			
-	Piston rod at one end																		
T	Through piston rod																		
Piston rod thread type																			
-	Male thread																		
F	Female thread																		
Cushioning																			
P	Elastic cushioning rings/pads at both ends																		
PPS	Pneumatic cushioning, self-adjusting at both ends																		
PPV	Pneumatic cushioning, adjustable at both ends																		
Position sensing																			
A	Via proximity sensor																		

Standards-based cylinders DSBG, to ISO 15552

Type code

-	N3								
Standard									
-	Based on ISO 15552								
N3	Corresponds to ISO 15552								
Corrosion protection									
-	Standard								
R3	High corrosion protection								
Temperature range									
-	Standard								
T1	0 ... +120 °C								
T3	-40 ... +80 °C								
T4	0 ... +150 °C								
Protection against particles									
-	Standard								
P2	Bellows on bearing cap								
Scraper variant									
-	None								
A2	Hard scraper								
A3	For unlubricated operation								
A6	Metal scraper								
EU certification									
-	None								
EX4	II 2GD								
Swivel mounting position									
-	None								
...V	0 ... 2800 mm								
Piston rod extension									
-	None								
...E	1 ... 500 mm								
Piston rod thread extension									
-	None								
...L	1 ... 70 mm								

Standards-based sbgd cylinders DSBG, to ISO 15552

Peripherals overview

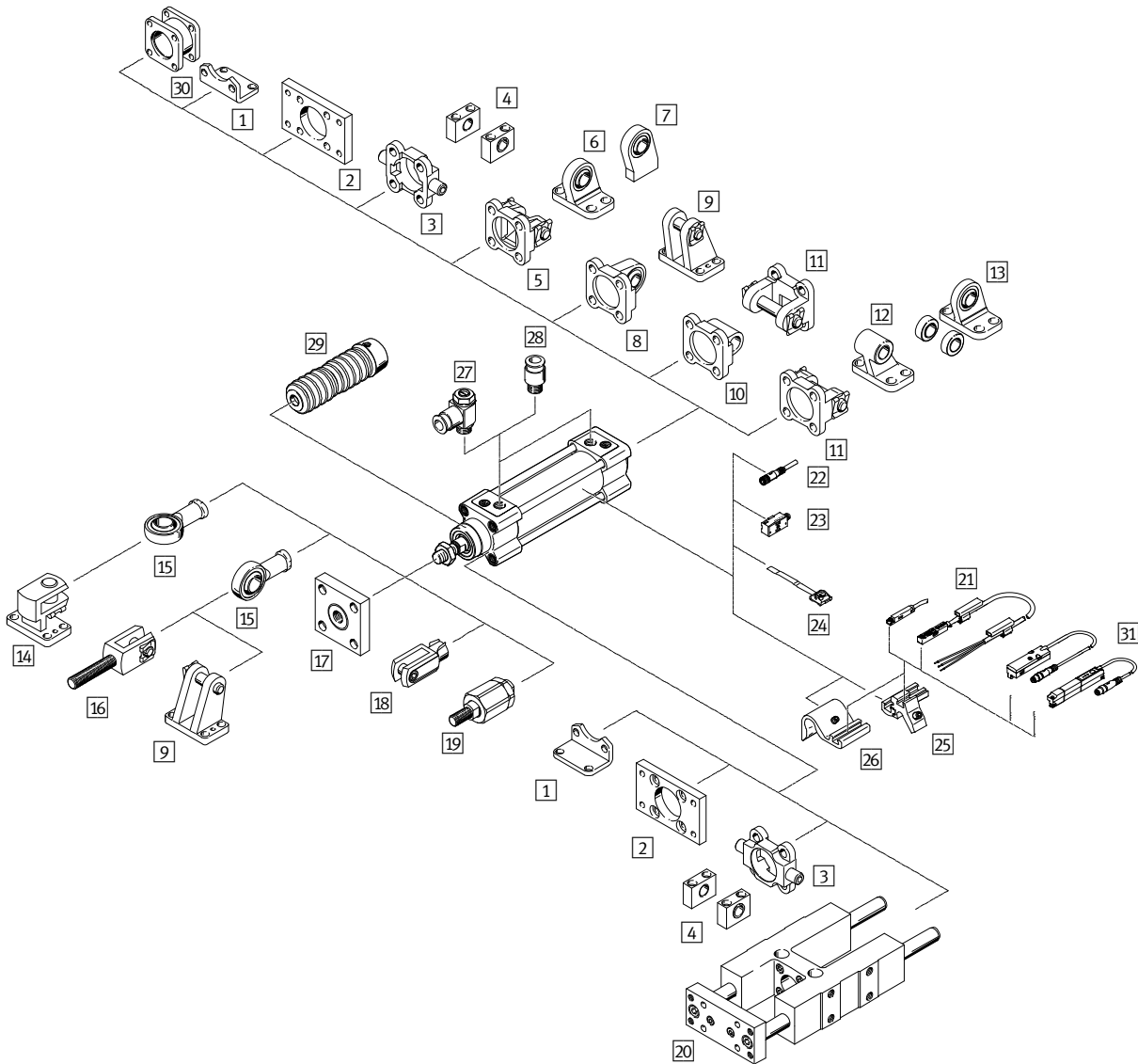

Mounting components and accessories		Description	DSBG-...			→ Page/ Internet
				-L/-U/ -L1	-T	
1	Foot mounting HNC/CRHNC	For bearing or end caps	■	■	■	26
2	Flange mounting FNC/CRFNG	- For bearing or end caps - Cannot be used on the bearing cap in combination with bellows kit DADB	■	■	■	27
3	Trunnion flange ZNCF/CRZNG	- For bearing or end caps - Cannot be used on the bearing cap in combination with bellows kit DADB	■	■	■	28
4	Trunnion support LNZG/CRLNZG	-	■	■	■	29
5	Swivel flange SNC	For end caps	■	■	-	30
6	Clevis foot LSNG	With spherical bearing	■	■	-	34

Standards-based cylinders DSBG, to ISO 15552

Peripherals overview

Mounting components and accessories						
	Description	DSBG-...			→ Page/ Internet	
			-L/-U/ -L1	-T		
7	Clevis foot LSNSG	Weld-on, with spherical bearing	■	■	-	34
8	Swivel flange SNCS/CRSNCS/SNCS-...-R3	With spherical bearing for end caps	■	■	-	32
9	Clevis foot LBG/LBG-...-R3	-	■	■	-	34
10	Swivel flange SNCL	For end caps	■	■	-	33
11	Swivel flange SNCB/SNCB-...-R3	For end caps	■	■	-	31
12	Clevis foot LNG/CRLNG	-	■	■	-	34
13	Clevis foot LSN	With spherical bearing	■	■	-	34
14	Right-angle clevis foot LQG	-	■	■	■	34
15	Rod eye SGS/CRSGS	With spherical bearing	■	■	■	35
16	Rod clevis SGA	With male thread	■	■	■	35
17	Coupling piece KSG	To compensate for radial deviations	■	■	■	35
	Coupling piece KSZ	For cylinders with a non-rotating piston rod to compensate for radial deviations	■	■	■	35
18	Rod clevis SG/CRSG	Permits a swivel motion of the cylinder in one plane	■	■	■	35
19	Self-aligning rod coupler FK, CRFK	For compensating radial and angular misalignments	■	■	■	35
20	Guide unit FENG	For protecting standards-based cylinders against rotation at high torque loads	■	■	■	41
21	Proximity sensor SME/SMT-8M	Can be integrated in the cylinder profile barrel	■	■	■	42
22	Connecting cable NEBU	-	■	■	■	42
23	Proximity sensor SMPO-1-H-B	-	■	■	■	44
24	Mounting kit SMBS	For proximity sensor SMPO-1-H-B	■	■	■	44
25	Mounting kit SMBZ-8- ...	For proximity sensor SME/SMT-8M, for piston \varnothing 32 ... 100	■	■	■	43
26	Sensor bracket DASP-M4- ...	For proximity sensor SME/SMT-8M, for piston \varnothing 125	■	■	■	43
27	One-way flow control valve GRLA	For speed regulation	■	■	■	grla
28	Push-in fitting QS	For connecting compressed air tubing with standard O.D.	■	■	■	qs
29	Bellows kit DADB	- Protects the cylinder (piston rod, seal and bearings) against a wide range of media and thus prevents premature wear - Can only be used in combination with an extended piston rod (E)	■	-	■	36
30	Multi-position kit DPNC	For connecting two cylinders with identical piston diameters to form a multi-position cylinder	■	-	■	40
31	Position sensor SMAT, SDAT	- Continuously senses the position of the piston - Has an analogue output	■	■	■	43

New
DSBG-...-L1

Standards-based cylinders DSBG, to ISO 15552

FESTO

Technical data

Function
P cushioning

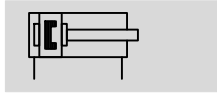

PPV cushioning

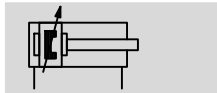

PPS cushioning

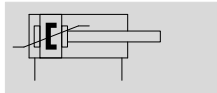

DIN



∅ - Diameter
32 ... 125 mm

— - Stroke length
1 ... 2800 mm

 - www.festo.com



General technical data								
Piston ∅		32	40	50	63	80	100	125
Design	Piston/piston rod/cylinder barrel							
Mode of operation	Double-acting							
Pneumatic port		G ¹ / ₈	G ¹ / ₄	G ¹ / ₄	G ³ / ₈	G ³ / ₈	G ¹ / ₂	G ¹ / ₂
Stroke								
DSBG-...	[mm]	1 ... 2800						
DSBG-...-Q	[mm]	1 ... 1500						-
DSBG-...-L1	[mm]	10 ... 1000						
DSBG-...-P2	[mm]	10 ... 500						-
DSBG-...-...E	[mm]	1 ... 2000						
DSBG-...-...L	[mm]	1 ... 2000						
Cushioning								
DSBG-...-P	Elastic cushioning rings/pads at both ends							
DSBG-...-PPV	Pneumatic cushioning, adjustable at both ends							
DSBG-...-PPS	Pneumatic cushioning, self-adjusting at both ends							
Cushioning length								
DSBG-...-PPV	[mm]	17	19	22	22	31	31	45
Position sensing	Via proximity sensor							
Type of mounting	Via internal thread/accessories							
Mounting position	Any							

Standards-based cylinders DSBG, to ISO 15552

Technical data

Operating and environmental conditions								
Piston \varnothing		32	40	50	63	80	100	125
Operating medium	Compressed air to ISO 8573-1:2010 [7:4:4]							
Note on operating/pilot medium	Lubricated operation possible (in which case lubricated operation will always be required)							
Operating pressure								
DSBG-...	[bar]	0.6 ... 12		0.4 ... 12			0.2 ... 10	
DSBG-...-L ¹⁾	[bar]	0.3 ... 12	0.25 ... 12		0.2 ... 12		0.15 ... 12	-
DSBG-...-U ¹⁾	[bar]	0.1 ... 12			0.05 ... 12		0.05 ... 10	
DSBG-...-L1 ¹⁾	[bar]	0.3 ... 12	0.25 ... 12		0.2 ... 12		0.15 ... 12	0.1 ... 10
DSBG-...-T3/-A2	[bar]	1 ... 12						1 ... 10
DSBG-...-A3	[bar]	1.5 ... 12		1 ... 12	0.6 ... 12		0.6 ... 10	
DSBG-...-A6	[bar]	1.5 ... 12						
Ambient temperature ²⁾								
DSBG-...	[°C]	-20 ... +80						
DSBG-...-L/-A1	[°C]	0 ... +80						
DSBG-...-L1	[°C]	0 ... +60						
DSBG-...-A6	[°C]	-40 ... +150						
DSBG-...-T1	[°C]	0 ... +120						
DSBG-...-T3	[°C]	-40 ... +80						
DSBG-...-T4	[°C]	0 ... +150						
DSBG-...-P2	[°C]	-10 ... +80						-
DSBG-...-EX4	[°C]	-20 ... +60						
Corrosion resistance class CRC								
DSBG-...		2 ³⁾						
DSBG-...-R3		3 ⁴⁾						

 1) Values apply only for strokes \leq 500 mm and after 10 double strokes.

In combination with cushioning PPV/PPS, the specifications only apply outside the cushioning range

2) Note operating range of proximity sensors

3) Corrosion resistance class CRC 2 to Festo standard FN 940070

Moderate corrosion stress. Indoor applications in which condensation may occur. External visible parts with primarily decorative requirements for the surface and which are in direct contact with the ambient atmosphere typical for industrial applications.

4) Corrosion resistance class CRC 3 to Festo standard FN 940070

High corrosion stress. Outdoor exposure under moderate corrosive conditions. External visible parts with primarily functional requirements for the surface and which are in direct contact with a normal industrial environment.

Standards-based cylinders DSBG, to ISO 15552

Technical data

Weight [g]							
Piston Ø	32	40	50	63	80	100	125
DSBG-...							
Product weight with 0 mm stroke	465	740	1190	1740	2660	3665	6611
Additional weight per 10 mm stroke	25	35	52	55	85	94	143
Moving mass with 0 mm stroke	110	205	365	430	810	1000	2245
Moving mass per 10 mm stroke	9	16	25	25	39	39	63
DSBG-...-Q							
Product weight with 0 mm stroke	503	755	1241	1821	2717	3827	–
Additional weight per 10 mm stroke	25	30	47	50	78	87	–
Moving mass with 0 mm stroke	115	170	332	391	757	890	–
Moving mass per 10 mm stroke	8	11	20	20	31	31	–
DSBG-...-T							
Product weight with 0 mm stroke	581	924	1523	2103	3243	4353	7450
Additional weight per 10 mm stroke	34	50	76	97	123	133	206
Moving mass with 0 mm stroke	181	339	613	684	1292	1516	3084
Moving mass per 10 mm stroke	18	32	50	50	78	78	126

ATEX ¹⁾	
ATEX category for gas	II 2G
Type of (ignition) protection for gas	c T4
ATEX category for dust	II 2D
Type of (ignition) protection for dust	c T120°C
Explosion-proof ambient temperature	–20°C ≤ Ta ≤ +60°C
CE marking (see declaration of conformity)	As per EU Explosion Protection Directive (ATEX)

1) Note the ATEX certification of the accessories.

Forces [N] and impact energy [J]							
Piston Ø	32	40	50	63	80	100	125
Theoretical force at 6 bar, advancing	483	754	1178	1870	3016	4712	7363
Theoretical force at 6 bar, retracting	415	633	990	1682	2721	4418	6881
Max. impact energy in the end positions							
DSBG-...	0.4	0.7	1.0	1.3	1.8	2.5	3.3
DSBG-...-L/-U/-L1/-T1/-T3/-T4	0.2	0.35	0.5	0.65	0.9	1.25	1.65

Permissible impact velocity

$$v_{perm.} = \sqrt{\frac{2 \times E_{perm.}}{m_{intrinsic} + m_{Load}}}$$

Maximum permissible load:

$$m_{Load} = \frac{2 \times E_{perm.}}{v^2} - m_{intrinsic}$$

$v_{perm.}$ Permissible impact velocity
 $E_{perm.}$ Max. impact energy
 $m_{intrinsic}$ Moving mass (drive)
 m_{Load} Moving payload

Standards-based cylinders DSBG, to ISO 15552

Technical data

Materials

Sectional view

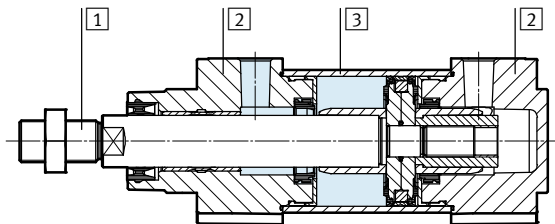

Standards-based cylinder

1	Piston rod, tie rod	
	DSBG-...	High-alloy steel
	DSBG-...-R3	High-alloy stainless steel
	DSBG-...-A2/-A6	Hard-chromium plated tempered steel
2	Cover	Die-cast aluminium, coated
3	Cylinder barrel	Anodised wrought aluminium alloy
-	Piston rod seal	
	DSBG-...	PUR
	DSBG-...-L/-U	FPM
	DSBG-...-L1	HNBR
	DSBG-...-T1/-T4/-A1	FPM
	DSBG-...-T3	PUR (suitable for low temperatures)
	DSBG-...-A3	UHMW-PE
	Rod wiper seal	
	DSBC-...-A6	CuZn
	Buffer seal	
	DSBG-...	PUR
	DSBG-...-U	FPM
	DSBG-...-T1/-T4	FPM
	DSBG-...-T3	PUR (suitable for low temperatures)
	Cushioning boss	
	DSBG-...	POM
	DSBG-...-L/-U	Aluminium
	DSBG-...-T1/-T3/-T4	Aluminium
-	Note on materials	
	DSBG-...	RoHS compliant
	DSBG-...-L/-U/-T3/-T4/-A3	Contains paint-wetting impairment substances

Standards-based cylinders DSBG, to ISO 15552

Technical data

Max. transverse force F_q as a function of stroke length l

Horizontal mounting

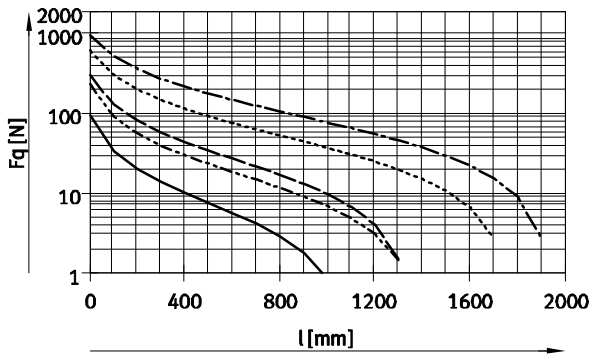

Vertical mounting

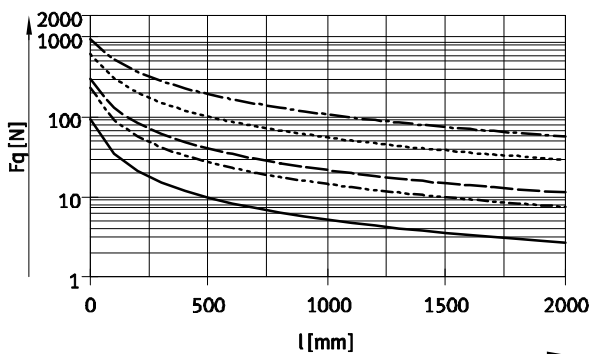

- \varnothing 32
- - - \varnothing 40
- · - \varnothing 50/63
- · - \varnothing 80/100
- · - \varnothing 125



Note
No transverse forces are permitted in combination with feature DSBG-...-L1.

Permissible torsional backlash with variant Q – With protection against rotation

Piston \varnothing	32	40	50	63	80	100
Torsional backlash [°]	± 0.65	± 0.6	± 0.45	± 0.45	± 0.45	± 0.45

Standards-based cylinders DSBG, to ISO 15552

Technical data

Max. transverse force F_q as a function of stroke length l and lever arm s

Q – With protection against rotation

Ø 32

Max. torque = 800 Nmm/max. stroke = 300 mm

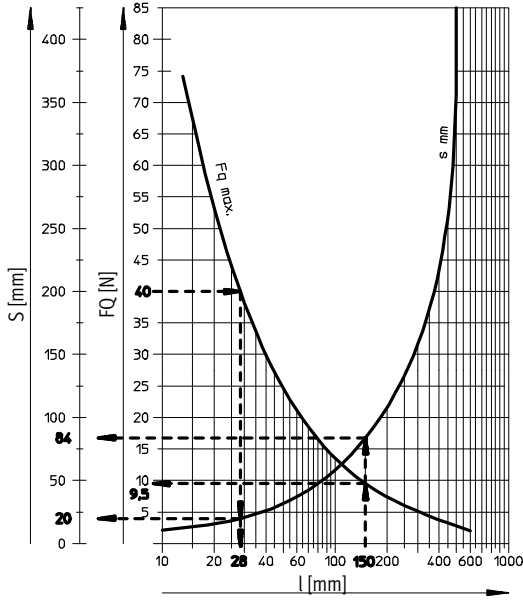

Ø 40

Max. torque = 1100 Nmm/max. stroke = 400 mm

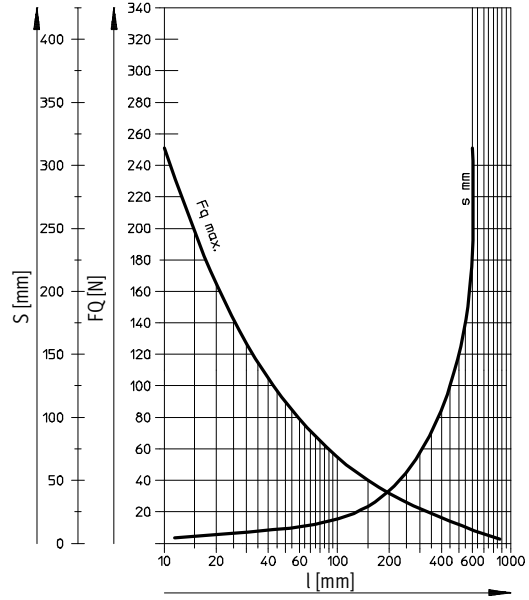

Ø 50/63

Max. torque = 1500 Nmm/max. stroke = 500 mm

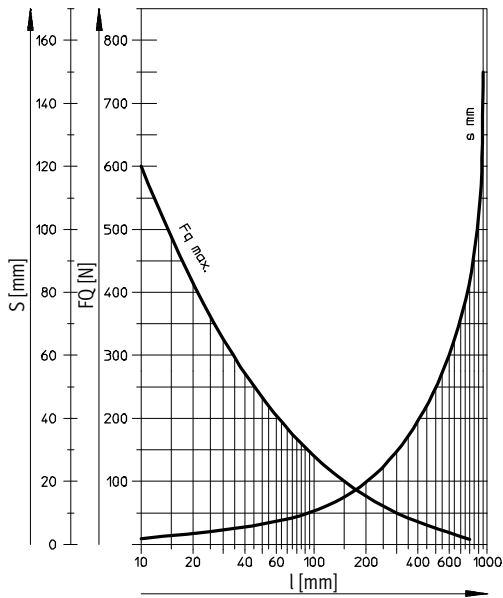

Ø 80/100

Max. torque = 3000 Nmm/max. stroke = 600 mm

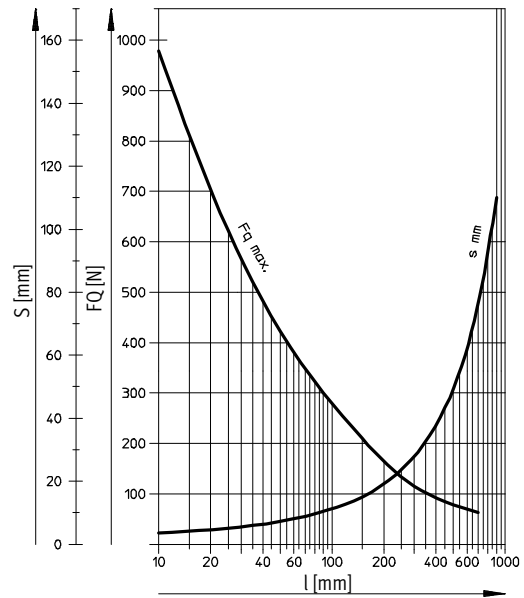

Examples for piston Ø 32 mm

Example 1:

Stroke length l = 150 mm

Result: Permissible

Transverse force F_q

= 9.5 N

Lever arm s = 84 mm

Example 2:

Transverse force F_q

= 40 N

Result: Permissible

Stroke length l = 28 mm

Lever arm s = 20 mm

Example 3:

Stroke length l = 150 mm

Lever arm s = 100 mm

$F_q = \frac{\text{Max. torque } 800 \text{ Nmm}}{\text{Lever arm } 100 \text{ mm}}$

= 8 N

Result: Permissible

$F_q = 8 \text{ N} < F_{q\text{max.}} = 9.5 \text{ N}$

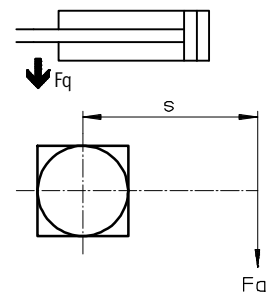

Standards-based cylinders DSBG, to ISO 15552

Technical data

FESTO

Dimensions

Download CAD data → www.festo.com

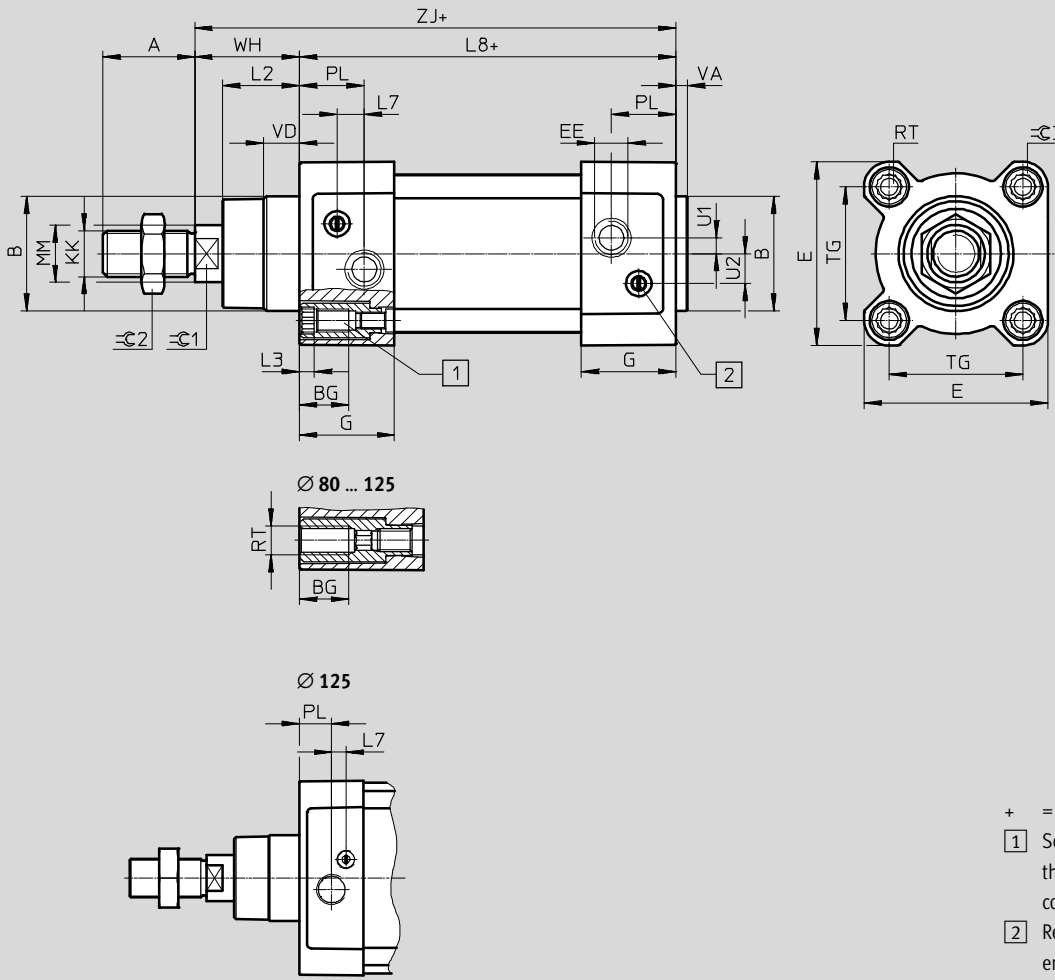

- + = plus stroke length
- 1 Socket head screw with female thread for mounting components
- 2 Regulating screw for adjustable end-position cushioning (PPV)

Variant

T – Through piston rod

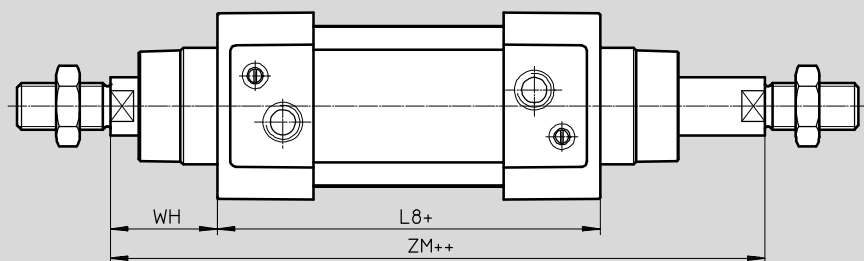

- + = plus stroke length
- ++ = plus 2x stroke length

Standards-based cylinders DSBG, to ISO 15552

Technical data

∅ [mm]	A -0.5	B ∅ d11	BG Min.	E +0.5	EE	G -0.2	U2 ±0.1	U1 ±0.1	KK
32	22	30	16	45	G1/8	28	5.7	5.25	M10x1.25
40	24	35	16	54	G1/4	33	8	4	M12x1.25
50	32	40	16	64	G1/4	33	10.4	5.5	M16x1.5
63	32	45	16	75	G3/8	40.5	12.75	6.25	M16x1.5
80	40	45	17	93	G3/8	43	12.5	8	M20x1.5
100	40	55	17	110	G1/2	48	13.5	10	M20x1.5
125	54	60	20	136	G1/2	44.7	13	8	M27x2

∅ [mm]	L2	L3 Max.	L7	L8 ±0.4	MM ∅	PL ±0.1	RT	TG ±0.3
32	18 _{-0.2}	5	6.5	94	12	19.5	M6	32.5
40	21.3 _{-0.2}	5	7.5	105	16	22.5	M6	38
50	26.8 _{-0.2}	5	9.5	106	20	22.5	M8	46.5
63	27 _{-0.2}	5	9	121	20	27.5	M8	56.5
80	34.2 _{-0.2}	-	11	128	25	30	M10	72
100	38 _{-0.2}	-	7.5	138	25	31.5	M10	89
125	45 _{-0.3}	-	10	160	32	22.5	M12	110

∅ [mm]	VA	VD +0.5	WH +2.2	ZJ +1.8	ZM +1	≈C1	≈C2	≈C3
32	4 _{-0.2}	10	25	119.1	146.1	10	16	6
40	4 _{-0.2}	10.5	28.7	133.9	164.8	13	18	6
50	4 _{-0.2}	11.5	35.6	141.8	179.8	17	24	8
63	4 _{-0.2}	15	35.9	157.1	195.4	17	24	8
80	4 _{-0.2}	15.7	45.4	173.6	221	22	30	6
100	4 _{-0.2}	19.2	49.3	187.5	238.8	22	30	6
125	6 _{-0.3}	20.5	64.1	225	290	27	41	8

Standards-based cylinders DSBG, to ISO 15552

Technical data

FESTO

Dimensions – Variants

Download CAD data → www.festo.com

Q – With protection against rotation

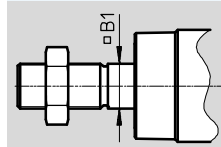

-  - Note
In combination with variant T, the piston rod is protected against rotation at one end.

F – Female thread

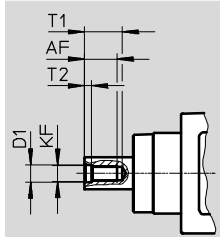

-  - Note
In combination with variant T, the piston rod has female threads at both ends.

...E – Piston rod extension

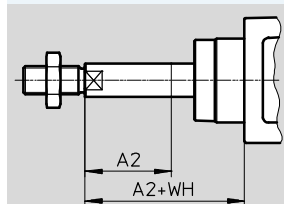

-  - Note
Piston rod extension at one end in combination with the variant T. Piston rod extension only at the square piston rod in combination with the variant T and Q.

...L – Piston rod thread extension

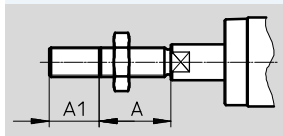

-  - Note
In combination with variant T, the piston rod thread is extended at both ends.

∅ [mm]	A	A1		A2		AF Min.
		Min.	Max.	Min.	Max.	
32	22	1	35	1	500	12
40	24	1	35	1	500	12
50	32	1	70	1	500	16
63	32	1	70	1	500	16
80	40	1	70	1	500	20
100	40	1	70	1	500	20
125	54	1	70	1	500	32

∅ [mm]	B1	D1	KF	T1	T2	WH +2.2
				Max.		
32	10	6.4	M6	16	2.6	25
40	12	8.4	M8	16	3.3	28.7
50	16	10.5	M10	21	4.7	35.6
63	16	10.5	M10	21	4.7	35.9
80	20	13	M12	26.5	6.1	45.4
100	20	13	M12	26.5	6.1	49.3
125	–	17	M16	40	8	64.1

Standards-based cylinders DSBG, to ISO 15552

Technical data

Dimensions – Variants

Download CAD data → www.festo.com

...V – Swivel mounting position

Note
 The dimensions for the swivel mounting position (...V) refer to the basic design without piston rod extension.

The swivel mounting can be moved at any time.

+ = plus stroke length
 +1/2 = plus half stroke length

∅ [mm]	TD ∅ e9	TK	TL h14	TM h14
32	12	20	12	50
40	16	25	16	63
50	16	28	16	75
63	20	30	20	90
80	20	32	20	110
100	25	38	25	132
125	25	44	25	160

∅ [mm]	UW	XG Min.	XJ Max.	XV
32	65	64±1.4	81±1.4	73±1.4
40	72	74.2±1.4	88.4±1.4	81.2±1.4
50	86	82.6±1.4	94.8±1.4	88.6±1.4
63	98	91.4±1.8	101.6±1.8	96.4±1.8
80	110	104.4±1.8	114.6±1.8	109.4±1.8
100	136	116.3±1.8	120.5±1.8	118.3±1.8
125	160	131.7±1.8	158.3±1.8	145±1.8

Standards-based cylinders DSBG, to ISO 15552

Technical data

Dimensions – Variants

Download CAD data → www.festo.com

P2 – Bellows on bearing cap

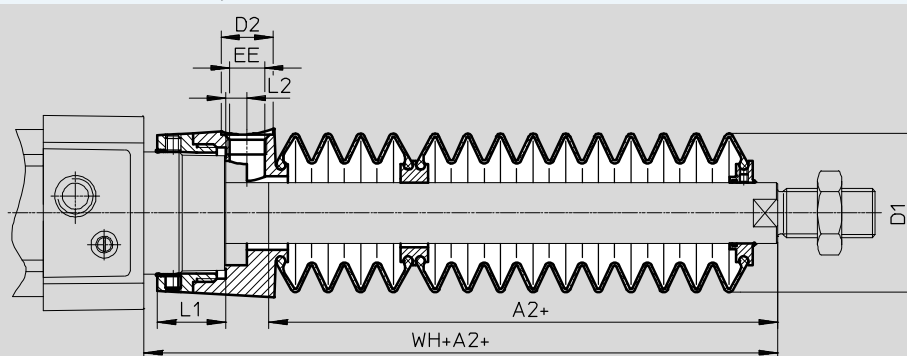

+ = plus stroke length

Ø Stroke [mm]	32							40						
	A2 ¹⁾	D1 Max.	D2	EE	L1	L2	WH+A2	A2 ¹⁾	D1 Max.	D2	EE	L1	L2	WH+A2
10 ... 50	29	38	14	G1/8	12.9	5.4	55	28	46	14	G1/8	16.3	5.4	56.7
51 ... 125	47						73	43						71.7
126 ... 175	61						87	56						84.7
176 ... 250	80						106	72						100.7
251 ... 300	96						122	86						114.7
301 ... 350	112						138	100						128.7
351 ... 375	114						140	101						129.7
376 ... 425	130						156	115						143.7
426 ... 475	145						171	130						158.7
476 ... 500	147						173	131						159.7

Ø Stroke [mm]	50							63						
	A2 ¹⁾	D1 Max.	D2	EE	L1	L2	WH+A2	A2 ¹⁾	D1 Max.	D2	EE	L1	L2	WH+A2
10 ... 50	28	57	17	G1/4	22.35	7	63.6	28	57	17	G1/4	22.4	7	63.9
51 ... 125	46						81.6	46						81.9
126 ... 175	56						91.6	56						91.9
176 ... 250	73						108.6	73						108.9
251 ... 300	86						121.6	86						121.9
301 ... 350	97						132.6	97						132.9
351 ... 375	105						140.6	105						140.9
376 ... 425	116						151.6	116						151.9
426 ... 475	126						161.6	126						161.9
476 ... 500	134						169.6	134						169.9

Ø Stroke [mm]	80							100						
	A2 ¹⁾	D1 Max.	D2	EE	L1	L2	WH+A2	A2 ¹⁾	D1 Max.	D2	EE	L1	L2	WH+A2
10 ... 50	25	93	17	G1/4	28	4	70.4	25	93	17	G1/4	28	4	74.3
51 ... 125	37						82.4	37						86.3
126 ... 175	49						94.4	49						98.3
176 ... 250	62						107.4	62						111.3
251 ... 300	74						119.4	74						123.3
301 ... 350	86						131.4	86						135.3
351 ... 375	87						132.4	87						136.3
376 ... 425	98						143.4	98						147.3
426 ... 475	110						155.4	110						159.3
476 ... 500	111						156.4	111						160.3

1) The dimension corresponds to the E value (piston rod extension) of the drive

Standards-based cylinders DSBG, to ISO 15552

Technical data

Ordering data					
Piston \varnothing [mm]	Stroke [mm]	With PPV cushioning		With PPS cushioning	
		Part No.	Type	Part No.	Type
32	25	1638842	DSBG-32-25-PPVA-N3	1645460	DSBG-32-25-PPSA-N3
	40	1638843	DSBG-32-40-PPVA-N3	1645461	DSBG-32-40-PPSA-N3
	50	1638844	DSBG-32-50-PPVA-N3	1645462	DSBG-32-50-PPSA-N3
	80	1638845	DSBG-32-80-PPVA-N3	1645463	DSBG-32-80-PPSA-N3
	100	1638846	DSBG-32-100-PPVA-N3	1645464	DSBG-32-100-PPSA-N3
	125	1638848	DSBG-32-125-PPVA-N3	1645465	DSBG-32-125-PPSA-N3
	160	1638849	DSBG-32-160-PPVA-N3	1645466	DSBG-32-160-PPSA-N3
	200	1638850	DSBG-32-200-PPVA-N3	1645467	DSBG-32-200-PPSA-N3
	250	1638851	DSBG-32-250-PPVA-N3	1645468	DSBG-32-250-PPSA-N3
	320	1638852	DSBG-32-320-PPVA-N3	1645469	DSBG-32-320-PPSA-N3
	400	1638853	DSBG-32-400-PPVA-N3	1645470	DSBG-32-400-PPSA-N3
	500	1638854	DSBG-32-500-PPVA-N3	1645471	DSBG-32-500-PPSA-N3
	1 ... 2800	1634781	DSBG-32-...-PPVA-N3	1634560	DSBG-32-...-PPSA-N3
40	25	1646547	DSBG-40-25-PPVA-N3	1646559	DSBG-40-25-PPSA-N3
	40	1646548	DSBG-40-40-PPVA-N3	1646560	DSBG-40-40-PPSA-N3
	50	1646549	DSBG-40-50-PPVA-N3	1646561	DSBG-40-50-PPSA-N3
	80	1646550	DSBG-40-80-PPVA-N3	1646562	DSBG-40-80-PPSA-N3
	100	1646551	DSBG-40-100-PPVA-N3	1646563	DSBG-40-100-PPSA-N3
	125	1646552	DSBG-40-125-PPVA-N3	1646564	DSBG-40-125-PPSA-N3
	160	1646553	DSBG-40-160-PPVA-N3	1646565	DSBG-40-160-PPSA-N3
	200	1646554	DSBG-40-200-PPVA-N3	1646566	DSBG-40-200-PPSA-N3
	250	1646555	DSBG-40-250-PPVA-N3	1646567	DSBG-40-250-PPSA-N3
	320	1646556	DSBG-40-320-PPVA-N3	1646568	DSBG-40-320-PPSA-N3
	400	1646557	DSBG-40-400-PPVA-N3	1646569	DSBG-40-400-PPSA-N3
	500	1646558	DSBG-40-500-PPVA-N3	1646570	DSBG-40-500-PPSA-N3
	1 ... 2800	1644503	DSBG-40-...-PPVA-N3	1645473	DSBG-40-...-PPSA-N3
50	25	1646709	DSBG-50-25-PPVA-N3	1646723	DSBG-50-25-PPSA-N3
	40	1646710	DSBG-50-40-PPVA-N3	1646724	DSBG-50-40-PPSA-N3
	50	1646711	DSBG-50-50-PPVA-N3	1646725	DSBG-50-50-PPSA-N3
	80	1646712	DSBG-50-80-PPVA-N3	1646726	DSBG-50-80-PPSA-N3
	100	1646713	DSBG-50-100-PPVA-N3	1646727	DSBG-50-100-PPSA-N3
	125	1646714	DSBG-50-125-PPVA-N3	1646728	DSBG-50-125-PPSA-N3
	160	1646715	DSBG-50-160-PPVA-N3	1646729	DSBG-50-160-PPSA-N3
	200	1646716	DSBG-50-200-PPVA-N3	1646730	DSBG-50-200-PPSA-N3
	250	1646717	DSBG-50-250-PPVA-N3	1646731	DSBG-50-250-PPSA-N3
	320	1646718	DSBG-50-320-PPVA-N3	1646732	DSBG-50-320-PPSA-N3
	400	1646719	DSBG-50-400-PPVA-N3	1646733	DSBG-50-400-PPSA-N3
	500	1646720	DSBG-50-500-PPVA-N3	1646734	DSBG-50-500-PPSA-N3
	1 ... 2800	1646708	DSBG-50-...-PPVA-N3	1646722	DSBG-50-...-PPSA-N3

 Note
Other variants in the modular product system → 24

Standards-based cylinders DSBG, to ISO 15552

FESTO

Technical data

Ordering data					
Piston Ø [mm]	Stroke [mm]	With PPV cushioning		With PPS cushioning	
		Part No.	Type	Part No.	Type
63	25	1646740	DSBG-63-25-PPVA-N3	1646754	DSBG-63-25-PPSA-N3
	40	1646741	DSBG-63-40-PPVA-N3	1646755	DSBG-63-40-PPSA-N3
	50	1646742	DSBG-63-50-PPVA-N3	1646756	DSBG-63-50-PPSA-N3
	80	1646743	DSBG-63-80-PPVA-N3	1646757	DSBG-63-80-PPSA-N3
	100	1646744	DSBG-63-100-PPVA-N3	1646758	DSBG-63-100-PPSA-N3
	125	1646745	DSBG-63-125-PPVA-N3	1646760	DSBG-63-125-PPSA-N3
	160	1646746	DSBG-63-160-PPVA-N3	1646761	DSBG-63-160-PPSA-N3
	200	1646747	DSBG-63-200-PPVA-N3	1646762	DSBG-63-200-PPSA-N3
	250	1646748	DSBG-63-250-PPVA-N3	1646763	DSBG-63-250-PPSA-N3
	320	1646749	DSBG-63-320-PPVA-N3	1646764	DSBG-63-320-PPSA-N3
	400	1646750	DSBG-63-400-PPVA-N3	1646765	DSBG-63-400-PPSA-N3
	500	1646751	DSBG-63-500-PPVA-N3	1646766	DSBG-63-500-PPSA-N3
	1 ... 2800	1646739	DSBG-63-...-PPVA-N3	1646753	DSBG-63-...-PPSA-N3
80	25	1646771	DSBG-80-25-PPVA-N3	1646785	DSBG-80-25-PPSA-N3
	40	1646772	DSBG-80-40-PPVA-N3	1646786	DSBG-80-40-PPSA-N3
	50	1646773	DSBG-80-50-PPVA-N3	1646787	DSBG-80-50-PPSA-N3
	80	1646774	DSBG-80-80-PPVA-N3	1646788	DSBG-80-80-PPSA-N3
	100	1646775	DSBG-80-100-PPVA-N3	1646789	DSBG-80-100-PPSA-N3
	125	1646776	DSBG-80-125-PPVA-N3	1646790	DSBG-80-125-PPSA-N3
	160	1646777	DSBG-80-160-PPVA-N3	1646791	DSBG-80-160-PPSA-N3
	200	1646778	DSBG-80-200-PPVA-N3	1646792	DSBG-80-200-PPSA-N3
	250	1646779	DSBG-80-250-PPVA-N3	1646793	DSBG-80-250-PPSA-N3
	320	1646780	DSBG-80-320-PPVA-N3	1646794	DSBG-80-320-PPSA-N3
	400	1646781	DSBG-80-400-PPVA-N3	1646795	DSBG-80-400-PPSA-N3
	500	1646782	DSBG-80-500-PPVA-N3	1646796	DSBG-80-500-PPSA-N3
	1 ... 2800	1646770	DSBG-80-...-PPVA-N3	1646784	DSBG-80-...-PPSA-N3
100	25	1646801	DSBG-100-25-PPVA-N3	1646815	DSBG-100-25-PPSA-N3
	40	1646802	DSBG-100-40-PPVA-N3	1646816	DSBG-100-40-PPSA-N3
	50	1646803	DSBG-100-50-PPVA-N3	1646817	DSBG-100-50-PPSA-N3
	80	1646804	DSBG-100-80-PPVA-N3	1646818	DSBG-100-80-PPSA-N3
	100	1646805	DSBG-100-100-PPVA-N3	1646819	DSBG-100-100-PPSA-N3
	125	1646806	DSBG-100-125-PPVA-N3	1646820	DSBG-100-125-PPSA-N3
	160	1646807	DSBG-100-160-PPVA-N3	1646821	DSBG-100-160-PPSA-N3
	200	1646808	DSBG-100-200-PPVA-N3	1646822	DSBG-100-200-PPSA-N3
	250	1646809	DSBG-100-250-PPVA-N3	1646823	DSBG-100-250-PPSA-N3
	320	1646810	DSBG-100-320-PPVA-N3	1646824	DSBG-100-320-PPSA-N3
	400	1646811	DSBG-100-400-PPVA-N3	1646825	DSBG-100-400-PPSA-N3
	500	1646812	DSBG-100-500-PPVA-N3	1646826	DSBG-100-500-PPSA-N3
	1 ... 2800	1646800	DSBG-100-...-PPVA-N3	1646814	DSBG-100-...-PPSA-N3

 Note
Other variants in the modular product system → 24

Standards-based cylinders DSBG, to ISO 15552

Technical data

Ordering data					
Piston Ø [mm]	Stroke [mm]	With PPV cushioning		With PPS cushioning	
		Part No.	Type	Part No.	Type
125	25	2159622	DSBG-125-25-PPVA-N3	2159907	DSBG-125-25-PPSA-N3
	40	2159623	DSBG-125-40-PPVA-N3	2159908	DSBG-125-40-PPSA-N3
	50	2159624	DSBG-125-50-PPVA-N3	2159909	DSBG-125-50-PPSA-N3
	80	2159625	DSBG-125-80-PPVA-N3	2159910	DSBG-125-80-PPSA-N3
	100	2159626	DSBG-125-100-PPVA-N3	2159911	DSBG-125-100-PPSA-N3
	125	2159627	DSBG-125-125-PPVA-N3	2159912	DSBG-125-125-PPSA-N3
	160	2159628	DSBG-125-160-PPVA-N3	2159913	DSBG-125-160-PPSA-N3
	200	2159629	DSBG-125-200-PPVA-N3	2159915	DSBG-125-200-PPSA-N3
	250	2159630	DSBG-125-250-PPVA-N3	2159916	DSBG-125-250-PPSA-N3
	320	2159631	DSBG-125-320-PPVA-N3	2159917	DSBG-125-320-PPSA-N3
	400	2159632	DSBG-125-400-PPVA-N3	2159918	DSBG-125-400-PPSA-N3
	500	2159633	DSBG-125-500-PPVA-N3	2159919	DSBG-125-500-PPSA-N3
	1 ... 2800	2158455	DSBG-125-...-PPVA-N3	2158471	DSBG-125-...-PPSA-N3

 Note

Other variants in the modular product system → 24

Standards-based cylinders DSBG to ISO 15552

Ordering data – Modular product system

Ordering table											
Size	32	40	50	63	80	100	125	Condi- tions	Code	Entry code	
M Module no.	1634484	1645477	1646707	1646738	1646769	1646799	2045493				
Function	Standards-based cylinder, double-acting, based on ISO 15552								DSBG	DSBG	
O Protection against rotation	None										
	With protection against rotation							-	1	-Q	
Running characteristics	Standard										
	Low friction							-	2	L	
	Constant, slow movement								2	U	
	Low friction for balancer applications								3	L1	
M Piston Ø [mm]	32	40	50	63	80	100	125		-...		
Stroke [mm]	1 ... 2800									-...	
O Piston rod	Piston rod at one end										
	Through piston rod									-T	
Piston rod thread type	Male thread										
	Female thread								4	F	
M Cushioning	Elastic cushioning rings/pads at both ends									-P	
	Pneumatic cushioning, self-adjusting at both ends								5	-PPS	
	Pneumatic cushioning, adjustable at both ends									-PPV	
↓ Position sensing	For proximity sensor									A	A

1 **Q** Not with L, U, N3, T3, T4, P2, A2, A3, A6
Only up to stroke of 1500 mm

2 **L, U** Not with T, R3, T1, T3, T4, P2, A2, A3, A6, EX4

3 **L1** Not with T, PPV, R3, T1, T3, T4, P2, A2, A3, A6, EX4

4 **F** Not with ...L

5 **PPS** Not with T1, T3, T4

 Note

If feature L is used in combination with transverse loads or strokes of above 500 mm, suitable measures must be taken to support the piston rod.
The operating pressure (→ 11) is applicable for strokes up to 500 mm.

 Note

If feature L1 is used in combination with strokes of above 500 mm, suitable measures must be taken to support the piston rod.
The operating pressure (→ 11) is applicable for strokes up to 500 mm.

M Mandatory data

O Options

Transfer order code

DSBG - - - - - - **A**

Standards-based cylinders DSBG, to ISO 15552

Ordering data – Modular products

Ordering table										
Size	32	40	50	63	80	100	125	Condi- tions	Code	Entry code
Standard	Based on ISO 15552									
	Corresponds to ISO 15552								-N3	
Corrosion protection	Standard									
	High corrosion protection							6	R3	
Temperature range	Standard									
	[°C]	Heat-resistant seals up to max. 120						7	T1	
	[°C]	-40 ... +80						7	T3	
	[°C]	0 ... +150						7	T4	
Protection against particles	Standard									
	Bellows on bearing cap						-	8	P2	
Scraper variant	None									
	Hard scraper								A2	
	For unlubricated operation								A3	
	Metal scraper								A6	
EU certification	None									
	II 2GD							9	EX4	
Swivel mounting position [mm]	None									
	0 ... 2800								-...V	
Piston rod extension [mm]	None									
	1 ... 500							10	-...E	
Piston rod thread extension [mm]	None									
	1 ... 35		1 ... 70					10	-...L	

- 6 R3** Not with A2, A6, ...V
- 7 T1, T3, T4** Not with P2, A2, A3, EX4
- 8 P2** Not with N3, A2, A3, A6, EX4
Only for strokes 10 ... 500 mm
- 9 EX4** Not with T1, T3, T4, P2, A3, A6
- 10 ...E, ...L** Only up to strokes of 2000 mm

 - Note
The piston rod extension for the bellows is automatically taken into consideration when feature P2 is selected. This means that there is no need to specify a value for feature ...E.

 - Note
When selecting feature ...E in combination with feature P2, the part of the piston rod extension ...E is not covered by the bellows.

 - Note
When feature P2 is selected in combination with feature T (through piston rod), the bellows is mounted on one side only.

- M** Mandatory data
- O** Options

Transfer order code

- - - -

Standards-based cylinders DSBG, to ISO 15552



Accessories

Foot mounting HNC/CRHNC

Materials:

- HNC: Galvanised steel
- CRHNC: High-alloy steel
- Free of copper and PTFE

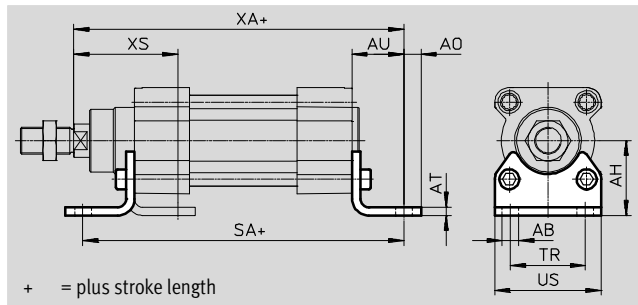

Dimensions and ordering data										
For \varnothing	AB \varnothing	AH	AO	AT	AU	SA	TR	US	XA	XS
[mm]										
32	7	32	6.5	4	24	142	32	45	143.1	46
40	10	36	9	4	28	161	36	54	161.9	52.7
50	10	45	9.5	5	32	170	45	64	173.8	62.6
63	10	50	12.5	5	32	185	50	75	189.1	62.9
80	12	63	15	6	41	210	63	93	214.6	80.4
100	14.5	71	17.5	6	41	220	75	110	228.5	84.3
125	16.5	90	22	8	45	250	90	131	270	102

For \varnothing	Basic design				Corrosion resistant			
	CRC ¹⁾	Weight [g]	Part No.	Type ²⁾	CRC ¹⁾	Weight [g]	Part No.	Type ²⁾
[mm]								
32	2	144	174369	HNC-32	4	139	176937	CRHNC-32
40	2	193	174370	HNC-40	4	188	176938	CRHNC-40
50	2	353	174371	HNC-50	4	341	176939	CRHNC-50
63	2	436	174372	HNC-63	4	424	176940	CRHNC-63
80	2	829	174373	HNC-80	4	809	176941	CRHNC-80
100	2	1009	174374	HNC-100	4	990	176942	CRHNC-100
125	2	1902	174375	HNC-125	4	1920	176943	CRHNC-125

- 1) Corrosion resistance class CRC 2 to Festo standard FN 940070
Moderate corrosion stress. Indoor applications in which condensation may occur. External visible parts with primarily decorative requirements for the surface and which are in direct contact with the ambient atmosphere typical for industrial applications.
Corrosion resistance class CRC 4 to Festo standard FN 940070
Particularly high corrosion stress. Outdoor exposure under extreme corrosive conditions. Parts exposed to aggressive media, for instance in the chemical or food industries. These applications may need to be supported by special tests (→ also FN 940082) using appropriate media.
- 2) Suitable for ATEX

Standards-based cylinders DSBG, to ISO 15552

Accessories

Flange mounting FNC/CRFNG

Materials:

FNC: Galvanised steel

CRFNG: High-alloy steel

Free of copper and PTFE

RoHS compliant

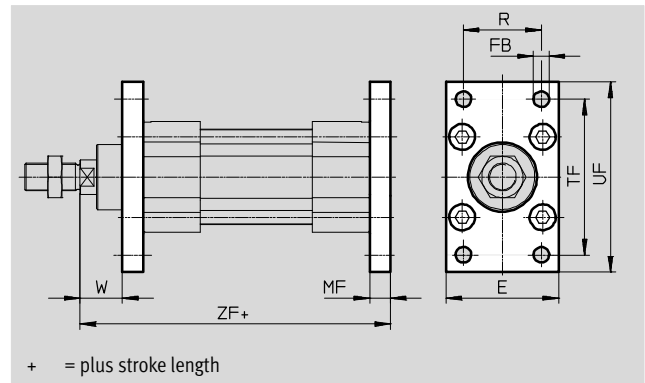

Dimensions and ordering data								
For Ø	E	FB	MF	R	TF	UF	W	ZF
[mm]		Ø H13						
32	45	7	10	32	64	80	16	129.1
40	54	9	10	36	72	90	18.7	143.9
50	65	9	12	45	90	110	23.6	153.8
63	75	9	12	50	100	120	23.9	169.1
80	93	12	16	63	126	150	29.4	189.6
100	110	14	16	75	150	175	33.3	203.5
125	132	16	20	90	180	210	45	245

For Ø	Basic design				Corrosion resistant			
	CRC ¹⁾	Weight	Part No.	Type ²⁾	CRC ¹⁾	Weight	Part No.	Type ²⁾
[mm]		[g]				[g]		
32	1	221	174376	FNC-32	4	220	161846	CRFNG-32
40	1	291	174377	FNC-40	4	291	161847	CRFNG-40
50	1	536	174378	FNC-50	4	526	161848	CRFNG-50
63	1	679	174379	FNC-63	4	680	161849	CRFNG-63
80	1	1495	174380	FNC-80	4	1508	161850	CRFNG-80
100	1	2041	174381	FNC-100	4	2054	161851	CRFNG-100
125	1	3775	174382	FNC-125	4	3787	185363	CRFNG-125

1) Corrosion resistance class CRC 1 to Festo standard FN 940070

Low corrosion stress. For dry indoor applications or transport and storage protection. Also applies to parts behind covers, in the non-visible interior area, and parts which are covered in the application (e.g. drive trunnions).

Corrosion resistance class CRC 4 to Festo standard FN 940070

Particularly high corrosion stress. Outdoor exposure under extreme corrosive conditions. Parts exposed to aggressive media, for instance in the chemical or food industries. These applications may need to be supported by special tests (➔ also FN 940082) using appropriate media.

2) Suitable for ATEX

Standards-based cylinders DSBG, to ISO 15552



Accessories

Trunnion flange ZNCF/CRZNG

Materials:

ZNCF: Stainless steel casting

CRZNG: Electropolished stainless steel casting

Free of copper and PTFE

RoHS compliant

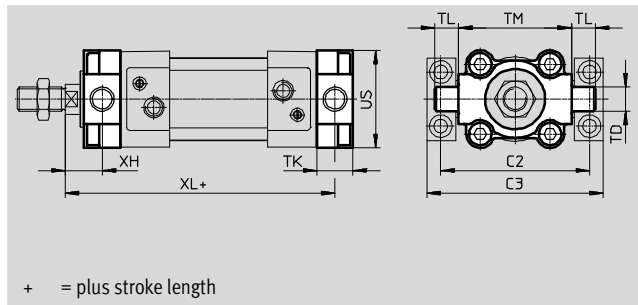

+ = plus stroke length

Dimensions and ordering data									
For \varnothing	C2	C3	TD	TK	TL	TM	US	XH	XL
[mm]			\varnothing e9						
32	71	86	12	16	12	50	45	18	127.1
40	87	105	16	20	16	63	54	18.7	143.9
50	99	117	16	24	16	75	64	23.6	153.8
63	116	136	20	24	20	90	75	23.9	169.1
80	136	156	20	28	20	110	93	31.4	187.6
100	164	189	25	38	25	132	110	30.3	206.5
125	192	217	25	50	25	160	131	40	250

For \varnothing	Basic design				Corrosion resistant			
	CRC ¹⁾	Weight [g]	Part No.	Type ²⁾	CRC ¹⁾	Weight [g]	Part No.	Type ²⁾
[mm]								
32	2	150	174411	ZNCF-32	4	150	161852	CRZNG-32
40	2	285	174412	ZNCF-40	4	285	161853	CRZNG-40
50	2	473	174413	ZNCF-50	4	473	161854	CRZNG-50
63	2	687	174414	ZNCF-63	4	687	161855	CRZNG-63
80	2	1296	174415	ZNCF-80	4	1296	161856	CRZNG-80
100	2	2254	174416	ZNCF-100	4	2254	161857	CRZNG-100
125	2	3484	174417	ZNCF-125	4	3484	185362	CRZNG-125

- Corrosion resistance class CRC 2 to Festo standard FN 940070
Moderate corrosion stress. Indoor applications in which condensation may occur. External visible parts with primarily decorative requirements for the surface and which are in direct contact with the ambient atmosphere typical for industrial applications.
Corrosion resistance class CRC 4 to Festo standard FN 940070
Particularly high corrosion stress. Outdoor exposure under extreme corrosive conditions. Parts exposed to aggressive media, for instance in the chemical or food industries. These applications may need to be supported by special tests (→ also FN 940082) using appropriate media.
- Suitable for ATEX

Standards-based cylinders DSBG, to ISO 15552

Accessories

Trunnion support LNZG

Materials:

Trunnion support: Anodised aluminium

Plain bearing: Plastic

Free of copper and PTFE

RoHS compliant

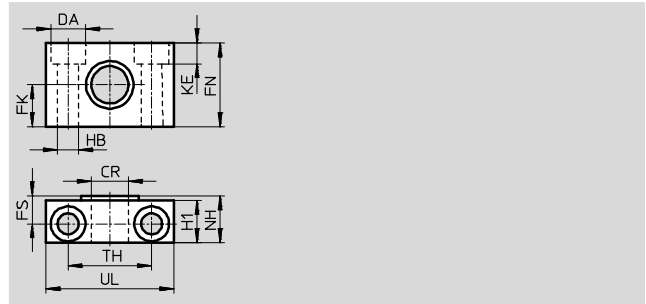
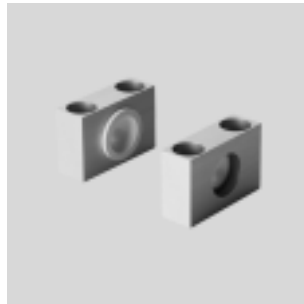

Dimensions and ordering data															
For \varnothing	CR	DA	FK	FN	FS	H1	HB	KE	NH	TH	UL	CRC ¹⁾	Weight	Part No.	Type
[mm]	\varnothing	\varnothing	\varnothing				\varnothing			± 0.2			[g]		
32	12	11	15	30	10.5	15	6.6	6.8	18	32	46	2	83	32959	LNZG-32
40, 50	16	15	18	36	12	18	9	9	21	36	55	2	129	32960	LNZG-40/50
63, 80	20	18	20	40	13	20	11	11	23	42	65	2	178	32961	LNZG-63/80
100, 125	25	20	25	50	16	24.5	14	13	28.5	50	75	2	306	32962	LNZG-100/125

1) Corrosion resistance class CRC 2 to Festo standard FN 940070

Moderate corrosion stress. Indoor applications in which condensation may occur. External visible parts with primarily decorative requirements for the surface and which are in direct contact with the ambient atmosphere typical for industrial applications.

Trunnion support CRLNZG

Materials:

High-alloy steel

Free of copper and PTFE

RoHS compliant

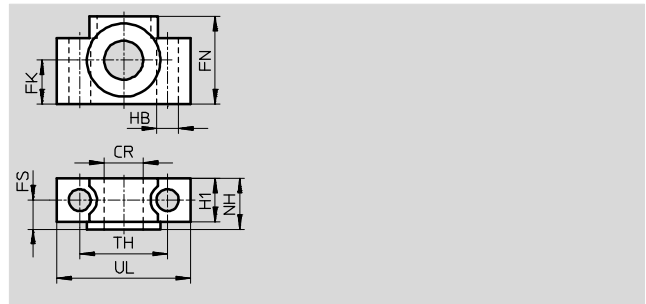
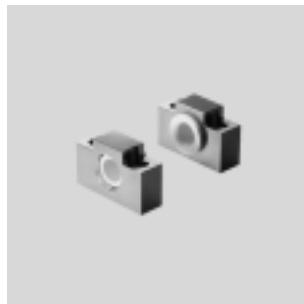

Dimensions and ordering data															
For \varnothing	CR	FK	FN	FS	H1	HB	NH	TH	UL	CRC ¹⁾	Weight	Part No.	Type		
[mm]	\varnothing	\varnothing				\varnothing		± 0.2			[g]				
32	12	15	30	10.5	15	6.6	18	32	46	4	205	161874	CRLNZG-32		
40, 50	16	18	36	12	18	9	21	36	55	4	323	161875	CRLNZG-40/50		
63, 80	20	20	40	13	20	11	23	42	65	4	435	161876	CRLNZG-63/80		
100, 125	25	25	50	16	24.5	14	28.5	50	75	4	739	161877	CRLNZG-100/125		

1) Corrosion resistance class CRC 4 to Festo standard FN 940070

Particularly high corrosion stress. Outdoor exposure under extreme corrosive conditions. Parts exposed to aggressive media, for instance in the chemical or food industries. These applications may need to be supported by special tests (→ also FN 940082) using appropriate media.

Standards-based cylinders DSBG, to ISO 15552



Accessories

Swivel flange SNC

Materials:
Die-cast aluminium
RoHS-compliant

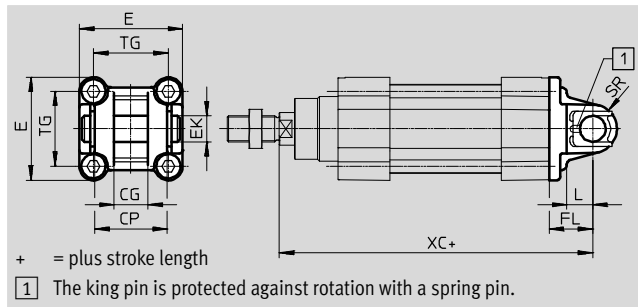

Dimensions and ordering data													
For Ø	CG	CP	E	EK Ø	FL ±0.2	L	SR	TG	XC	CRC ¹⁾	Weight [g]	Part No.	Type ²⁾
[mm]	H14	h14		H9									
32	14	34	45 ^{+0.2/-0.5}	10	22	13	10	32.5	141.1	2	93	174383	SNC-32
40	16	40	54 ^{-0.5}	12	25	16	12	38	158.9	2	140	174384	SNC-40
50	21	45	64 ^{-0.6}	16	27	16	12	46.5	168.8	2	234	174385	SNC-50
63	21	51	75 ^{-0.6}	16	32	21	16	56.5	189.1	2	331	174386	SNC-63
80	25	65	93 ^{-0.8}	20	36	22	16	72	209.6	2	618	174387	SNC-80
100	25	75	110 ^{+0.3/-0.8}	20	41	27	20	89	228.5	2	865	174388	SNC-100
125	37	97	131 ^{-0.8}	30	50	30	25	110	275	2	1728	174389	SNC-125

- 1) Corrosion resistance class CRC 2 to Festo standard FN 940070
 Moderate corrosion stress. Indoor applications in which condensation may occur. External visible parts with primarily decorative requirements for the surface and which are in direct contact with the ambient atmosphere typical for industrial applications.
- 2) Suitable for ATEX areas

Standards-based cylinders DSBG, to ISO 15552

Accessories

Swivel flange SNCB/SNCB-...-R3

Materials:
 SNCB: Die-cast aluminium
 SNCB-...-R3: Die-cast aluminium with protective coating
 Free of copper and PTFE
 RoHS-compliant

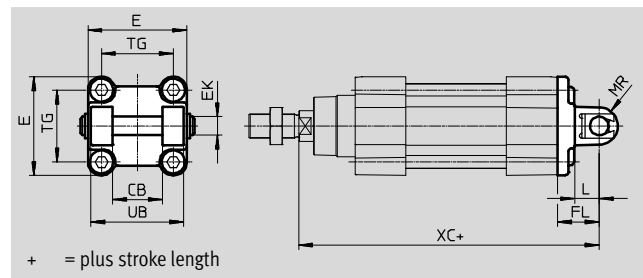

Dimensions and ordering data									
For Ø	CB	E	EK	FL	L	MR	TG	UB	XC
[mm]	H14		Ø H9/e8	±0.2		-0.5		h14	
32	26	45 ^{+0.2/-0.5}	10	22	13	8.5	32.5	45	141.1
40	28	54 ^{-0.5}	12	25	16	12	38	52	158.9
50	32	64 ^{-0.6}	12	27	16	12	46.5	60	168.8
63	40	75 ^{-0.6}	16	32	21	16	56.5	70	189.1
80	50	93 ^{-0.8}	16	36	22	16	72	90	209.6
100	60	110 ^{+0.3/-0.8}	20	41	27	20	89	110	228.5
125	70	131 ^{-0.8}	25	50	30	25	110	130	275

For Ø [mm]	Basic design				R3 – High corrosion protection			
	CRC ¹⁾	Weight [g]	Part No.	Type	CRC ¹⁾	Weight [g]	Part No.	Type
32	2	103	174390	SNCB-32	3	100	176944	SNCB-32-R3
40	2	155	174391	SNCB-40	3	151	176945	SNCB-40-R3
50	2	232	174392	SNCB-50	3	228	176946	SNCB-50-R3
63	2	375	174393	SNCB-63	3	371	176947	SNCB-63-R3
80	2	636	174394	SNCB-80	3	632	176948	SNCB-80-R3
100	2	1035	174395	SNCB-100	3	986	176949	SNCB-100-R3
125	2	1860	174396	SNCB-125	3	1776	176950	SNCB-125-R3

1) Corrosion resistance class CRC 2 to Festo standard FN 940070
 Moderate corrosion stress. Indoor applications in which condensation may occur. External visible parts with primarily decorative requirements for the surface and which are in direct contact with the ambient atmosphere typical for industrial applications.
 Corrosion resistance class CRC 3 to Festo standard FN 940070
 High corrosion stress. Outdoor exposure under moderate corrosive conditions. External visible parts with primarily functional requirements for the surface and which are in direct contact with a normal industrial environment.

Standards-based cylinders DSBG, to ISO 15552

Accessories



Swivel flange

SNCS/CRSNCS/SNCS-...-R3

Materials:

SNCS 32 ... 80: Die-cast aluminium

SNCS 100 ... 125:

Wrought aluminium alloy

CRSNCS 32 ... 80:

High-alloy stainless steel

SNCS-...-R3: 100 ... 125: Wrought aluminium alloy with protective coating

RoHS-compliant

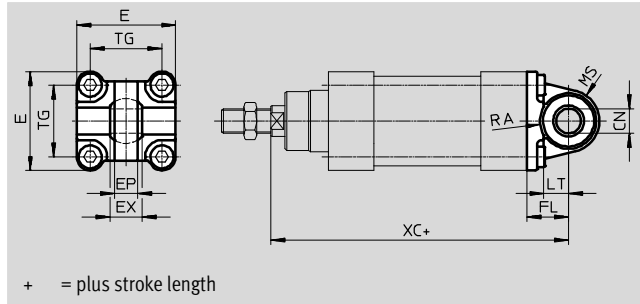
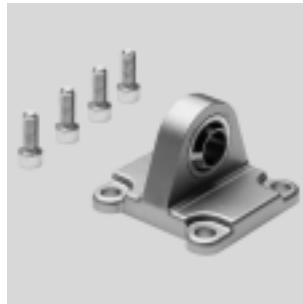

+ = plus stroke length

Dimensions and ordering data							
For \varnothing	CN \varnothing		E		EP	EX	FL
[mm]	DSBG-...	DSBG-...-R3	DSBG-...	DSBG-...-R3	± 0.2		± 0.2
32	10 ^{+0.013}	10 ^{+0.015/-0.04}	45 ^{+0.2/-0.5}	45 ^{-0.5}	10.5	14	22
40	12 ^{+0.015}	12 ^{+0.018/-0.04}	54 ^{-0.5}	54 ^{-0.5}	12	16	25
50	16 ^{+0.015}	16 ^{+0.018/-0.04}	64 ^{-0.6}	64 ^{-0.6}	15	21	27
63	16 ^{+0.015}	16 ^{+0.018/-0.04}	75 ^{-0.6}	75 ^{-0.6}	15	21	32
80	20 ^{+0.018}	20 ^{+0.021/-0.04}	93 ^{-0.8}	93 ^{-0.8}	18	25	36
100	20 ^{+0.018}	20 ^{+0.021/-0.04}	109 ^{+1/-0.7}	109 ^{+1/-0.7}	18	25	41
125	30 ^{+0.018}	30 ^{+0.021/-0.04}	132 ^{+1/-0.7}	132 ^{+1/-0.7}	25	37	50

For \varnothing	LT	MS		RA		TG	XC
[mm]		DSBG	DSBG-...-R3	DSBG +1	DSBG-...-R3 +1		
32	13	15 ^{+0.5}	15 ^{+0.5}	14.5	14.5	32.5	141.1
40	16	17 ^{+0.5}	17 ^{+0.5}	17.5	17.5	38	158.9
50	16	20 ^{+0.5}	20 ^{+0.5}	18.5	19	46.5	168.8
63	21	23 ^{-0.5}	22 ^{+0.5}	23	23	56.5	189.1
80	22	28 ^{-0.5}	27 ^{+0.5}	25	25	72	209.6
100	27	30 ± 0.5	30 ± 0.5	95	100	89	228.5
125	30	39 ± 0.5	39 ± 0.5	100	100	110	275

For \varnothing [mm]	Basic version				High corrosion protection			
	CRC ¹⁾	Weight [g]	Part No.	Type	CRC ¹⁾	Weight [g]	Part No.	Type
32	2	86	174397	SNCS-32	4	161	2895920	CRSNCS-32
40	2	122	174398	SNCS-40	4	239	2895921	CRSNCS-40
50	2	216	174399	SNCS-50	4	403	2895922	CRSNCS-50
63	2	281	174400	SNCS-63	4	576	2895923	CRSNCS-63
80	2	557	174401	SNCS-80	4	1173	2895924	CRSNCS-80
100	2	683	174402	SNCS-100	3	684	2895925	SNCS-100-R3
125	2	1369	174403	SNCS-125	3	1369	2895926	SNCS-125-R3

1) Corrosion resistance class CRC 2 to Festo standard FN 940070

Moderate corrosion stress. Indoor applications in which condensation may occur. External visible parts with primarily decorative requirements for the surface and which are in direct contact with the ambient atmosphere typical for industrial applications.

Corrosion resistance class CRC 3 to Festo standard FN 940070

High corrosion stress. Outdoor exposure under moderate corrosive conditions. External visible parts with primarily functional requirements for the surface and which are in direct contact with a normal industrial environment.

Corrosion resistance class CRC 4 to Festo standard FN 940070

Particularly high corrosion stress. Outdoor exposure under extreme corrosive conditions. Parts exposed to aggressive media, for instance in the chemical or food industries. These applications may need to be supported by special tests (→ also FN 940082) using appropriate media.

Standards-based cylinders DSBG, to ISO 15552

Accessories

Swivel flange SNCL

Materials:
Die-cast aluminium
Free of copper and PTFE
RoHS-compliant

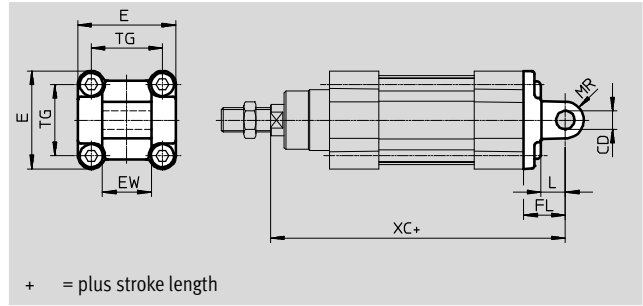





Dimensions and ordering data												
For \varnothing	CD	E	EW	FL	L	MR	TG	XC	CRC ¹⁾	Weight	Part No.	Type
[mm]	\varnothing H9		h12	± 0.2						[g]		
32	10	45 ^{+0.2/-0.5}	26	22	13	10	32.5	141.1	2	71	174404	SNCL-32
40	12	54 _{-0.5}	28	25	16	12	38	158.9	2	95	174405	SNCL-40
50	12	64 _{-0.6}	32	27	16	12	46.5	168.8	2	158	174406	SNCL-50
63	16	75 _{-0.6}	40	32	21	16	56.5	189.1	2	225	174407	SNCL-63
80	16	93 _{-0.8}	50	36	22	16	72	209.6	2	436	174408	SNCL-80
100	20	110 ^{+0.3/-0.8}	60	41	27	20	89	228.5	2	606	174409	SNCL-100
125	25	131 _{-0.8}	70	50	30	25	110	275	2	1135	174410	SNCL-125

1) Corrosion resistance class CRC 2 to Festo standard FN 940070
Moderate corrosion stress. Indoor applications in which condensation may occur. External visible parts with primarily decorative requirements for the surface and which are in direct contact with the ambient atmosphere typical for industrial applications.

Standards-based cylinders DSBG, to ISO 15552

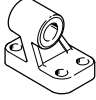
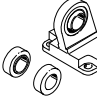
Accessories

FESTO

Ordering data – Mounting components				Technical data → Internet: clevis foot			
Description	For Ø	Part No.	Type	Description	For Ø	Part No.	Type
Clevis foot LNG				Clevis foot LSN			
	32	33890	LNG-32		32	5561	LSN-32
	40	33891	LNG-40		40	5562	LSN-40
	50	33892	LNG-50		50	5563	LSN-50
	63	33893	LNG-63		63	5564	LSN-63
	80	33894	LNG-80		80	5565	LSN-80
	100	33895	LNG-100		100	5566	LSN-100
	125	33896	LNG-125		125	6987	LSN-125
Clevis foot LSNG				Clevis foot LSNSG			
	32	31740	LSNG-32		32	31747	LSNSG-32
	40	31741	LSNG-40		40	31748	LSNSG-40
	50	31742	LSNG-50		50	31749	LSNSG-50
	63	31743	LSNG-63		63	31750	LSNSG-63
	80	31744	LSNG-80		80	31751	LSNSG-80
	100	31745	LSNG-100		100	31752	LSNSG-100
	125	31746	LSNG-125		125	31753	LSNSG-125
Clevis foot LBG¹⁾				Right-angle clevis foot LQG¹⁾			
	32	31761	LBG-32		32	31768	LQG-32
	40	31762	LBG-40		40	31769	LQG-40
	50	31763	LBG-50		50	31770	LQG-50
	63	31764	LBG-63		63	31771	LQG-63
	80	31765	LBG-80		80	31772	LQG-80
	100	31766	LBG-100		100	31773	LQG-100
	125	31767	LBG-125		125	31774	LQG-125



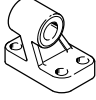

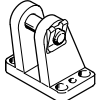
1) Suitable for ATEX

Ordering data – Mounting components, corrosion-resistant			Technical data → Internet: crlng	
Description	For Ø	Part No.	Type	
Clevis foot CRLNG				
	32	161840	CRLNG-32	
	40	161841	CRLNG-40	
	50	161842	CRLNG-50	
	63	161843	CRLNG-63	
	80	161844	CRLNG-80	
	100	161845	CRLNG-100	
	125	176951	CRLNG-125	



Ordering – Mounting attachments, high corrosion protection			Technical data → Internet: clevis foot	
Designation	For Ø	Part No.	Type	
Clevis foot LBG-R3				
	32	2078790	LBG-32-R3	
	40	2078792	LBG-40-R3	
	50	2078794	LBG-50-R3	
	63	2078795	LBG-63-R3	
	80	2078797	LBG-80-R3	
	100	2078799	LBG-100-R3	
	125	2078337	LBG-125-R3	

Standards-based cylinders DSBG, to ISO 15552

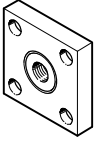
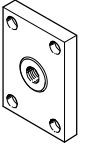
Accessories

Ordering data – Piston rod attachments				Technical data → Internet: piston-rod attachment			
Description	For Ø	Part No.	Type	Description	For Ø	Part No.	Type
Rod eye SGS				Rod clevis SGA¹⁾			
	32	9261	SGS-M10x1,25		32	32954	SGA-M10x1,25
	40	9262	SGS-M12x1,25		40	10767	SGA-M12x1,25
	50	9263	SGS-M16x1,5		50	10768	SGA-M16x1,5
	63						
	80	9264	SGS-M20x1,5		80	10769	SGA-M20x1,5
	100	10774	SGS-M27x2		100	10770	SGA-M27x2
	125						
Rod clevis SG¹⁾				Self-aligning rod coupler FK¹⁾			
	32	6144	SG-M10x1,25		32	6140	FK-M10x1,25
	40	6145	SG-M12x1,25		40	6141	FK-M12x1,25
	50	6146	SG-M16x1,5		50	6142	FK-M16x1,5
	63						
80	6147	SG-M20x1,5	80	6143	FK-M20x1,5		
	100	14987	SG-M27x2-B	100	10485	FK-M27x2	
	125						
Coupling piece KSG¹⁾				Coupling piece KSZ¹⁾			
	32	32963	KSG-M10x1,25		32	36125	KSZ-M10x1,25
	40	32964	KSG-M12x1,25		40	36126	KSZ-M12x1,25
	50	32965	KSG-M16x1,5		50	36127	KSZ-M16x1,5
	63						
	80	32966	KSG-M20x1,5		80	36128	KSZ-M20x1,5
	100	32967	KSG-M27x2		100	-	-
	125						

1) Suitable for ATEX

Ordering data – Piston rod attachments, corrosion-resistant				Technical data → Internet: piston-rod attachment			
Description	For Ø	Part No.	Type	Description	For Ø	Part No.	Type
Rod eye CRSGS				Rod clevis CRSG¹⁾			
	32	195582	CRSGS-M10x1,25		32	13569	CRSG-M10x1,25
	40	195583	CRSGS-M12x1,25		40	13570	CRSG-M12x1,25
	50	195584	CRSGS-M16x1,5		50	13571	CRSG-M16x1,5
	63						
	80	195585	CRSGS-M20x1,5		80	13572	CRSG-M20x1,5
	100	195586	CRSGS-M27x2		100	185361	CRSG-M27x2
	125						
Self-aligning rod coupler CRFK¹⁾							
	32	2305778	CRFK-M10x1,25				
	40	2305779	CRFK-M12x1,25				
	50	2490673	CRFK-M16x1,5				
	63						
	80	2545677	CRFK-M20x1,5				
	100						

1) Suitable for ATEX

Standards-based cylinders DSBG, to ISO 15552



Accessories

Bellows kit DADB



General technical data							
Type DADB-V6-		32	40	50	63	80	100
Max. stroke range of cylinder ¹⁾	[mm]	10 ... 500	10 ... 500	10 ... 500	10 ... 500	10 ... 500	10 ... 500
Type of mounting		Via threaded pin					
Mounting position		Any					
Resistance to media		Dust, chippings, oil, grease, fuel (→ Internet: Resistance to media)					
Ambient temperature ²⁾	[°C]	-10 ... +80					
Degree of protection		IP54					
Corrosion resistance class CRC ³⁾		3					

1) In combination with bellows kit DADB

2) Note operating range of proximity sensors and cylinder

3) Corrosion resistance class CRC 3 to Festo standard FN 940070

High corrosion stress. Outdoor exposure under moderate corrosive conditions. External visible parts with primarily functional requirements for the surface and which are in direct contact with a normal industrial environment.

Materials

Sectional view

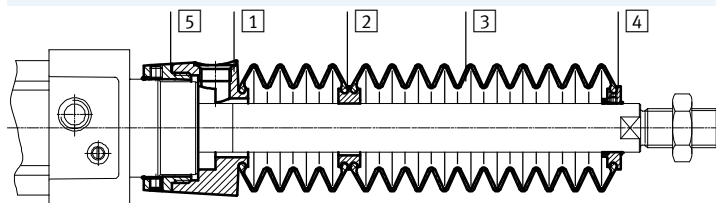

Bellows		
1	Connection	Polyamide
2	Adapter	Polyamide
3	Bellows	NBR
4	End piece	Polyamide
5	Connector	Polyamide
-	O-ring	NBR
Note on materials		Free of copper and PTFE
		RoHS compliant

Weight [g]							
Type DADB-V6-		32	40	50	63	80	100
Stroke [mm]							
10 ... 50		29	42	71	69	99	124
51 ... 125		41	56	91	89	127	152
126 ... 175		52	68	105	103	140	165
176 ... 250		66	85	129	127	193	218
251 ... 300		79	100	147	145	231	255
301 ... 350		92	115	166	164	268	293
351 ... 375		92	115	167	165	259	284
376 ... 425		104	129	185	183	296	321
426 ... 475		117	144	204	202	334	359
476 ... 500		117	144	205	203	324	349

Standards-based cylinders DSBG, to ISO 15552

Accessories

Travel speed v as a function of tubing length l

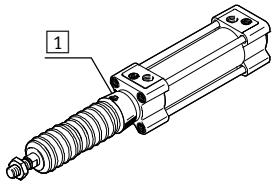

The bellows kit is a leak-free system. To prevent unwanted media from being drawn in, the supply and exhaust air must be ducted via a pressure compensation hole in the

connection part **1**.

The pressure generated in the bellows kit by the positioning motion is primarily defined by the travel speed

and tubing length. The recommended tubing length based on the travel speed of the drive can be read from the graph.

Advancing

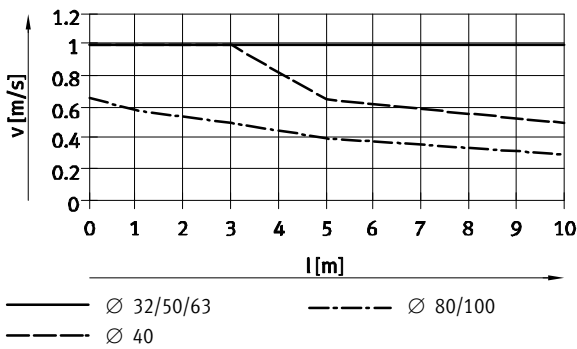

Retracting

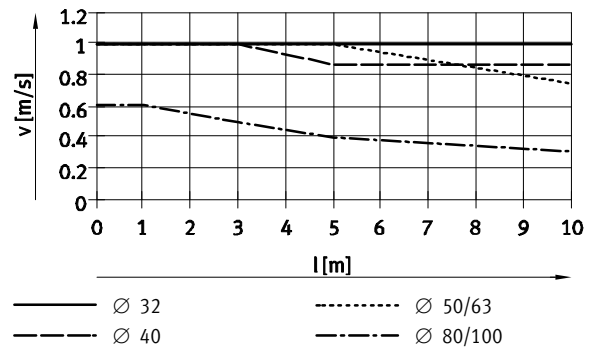

Note
The push-in fittings in the adjacent table must be used for the pressure compensation hole. Silencers can be used as an alternative. This reduces the travel speed slightly.

Tubing size and push-in fitting for pressure compensation hole			
Ø [mm]	Tubing O.D. [mm]	Push-in fitting	
		Part No.	Type
32, 40	8	186109	QS-G ¹ / ₈ -8-1
		578376	NPQH-DK-G18-Q8-P10
		578362	NPQH-D-G18-S8-P10
50, 63, 80, 100	12	186350	QS-G ¹ / ₄ -12
		578344	NPQH-D-G14-Q12-P10
		578366	NPQH-D-G14-S12-P10

Standards-based cylinders DSBG, to ISO 15552

Accessories

Dimensions Download CAD data → www.festo.com

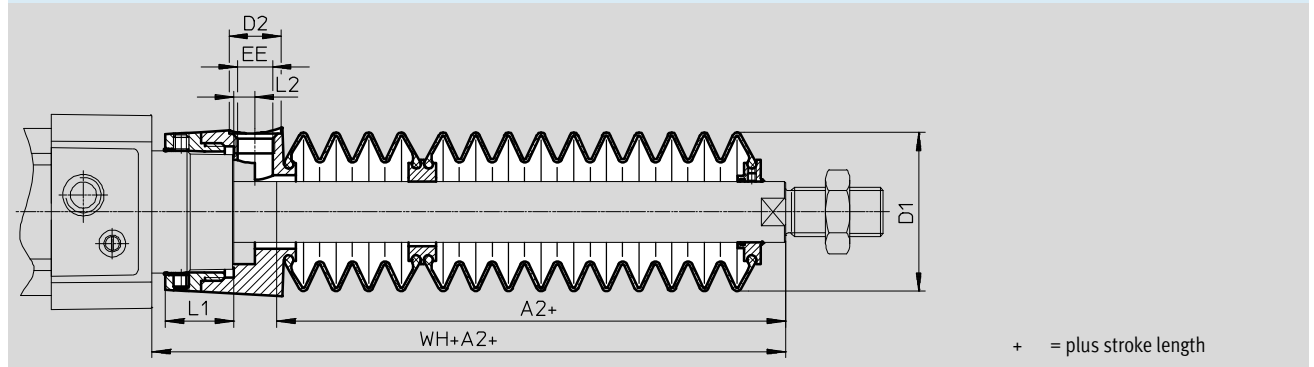

Ø Stroke [mm]	32							40						
	A2 ¹⁾	D1 Max.	D2	EE	L1	L2	WH+A2	A2 ¹⁾	D1 Max.	D2	EE	L1	L2	WH+A2
10 ... 50	29	38	14	G1/8	12.9	5.4	55	28	46	14	G1/8	16.3	5.4	56.7
51 ... 125	47						73	43						71.7
126 ... 175	61						87	56						84.7
176 ... 250	80						106	72						100.7
251 ... 300	96						122	86						114.7
301 ... 350	112						138	100						128.7
351 ... 375	114						140	101						129.7
376 ... 425	130						156	115						143.7
426 ... 475	145						171	130						158.7
476 ... 500	147						173	131						159.7

Ø Stroke [mm]	50							63						
	A2 ¹⁾	D1 Max.	D2	EE	L1	L2	WH+A2	A2 ¹⁾	D1 Max.	D2	EE	L1	L2	WH+A2
10 ... 50	28	57	17	G1/4	22.35	7	63.6	28	57	17	G1/4	22.4	7	63.9
51 ... 125	46						81.6	46						81.9
126 ... 175	56						91.6	56						91.9
176 ... 250	73						108.6	73						108.9
251 ... 300	86						121.6	86						121.9
301 ... 350	97						132.6	97						132.9
351 ... 375	105						140.6	105						140.9
376 ... 425	116						151.6	116						151.9
426 ... 475	126						161.6	126						161.9
476 ... 500	134						169.6	134						169.9

Ø Stroke [mm]	80							100						
	A2 ¹⁾	D1 Max.	D2	EE	L1	L2	WH+A2	A2 ¹⁾	D1 Max.	D2	EE	L1	L2	WH+A2
10 ... 50	25	93	17	G1/4	28	4	70.4	25	93	17	G1/4	28	4	74.3
51 ... 125	37						82.4	37						86.3
126 ... 175	49						94.4	49						98.3
176 ... 250	62						107.4	62						111.3
251 ... 300	74						119.4	74						123.3
301 ... 350	86						131.4	86						135.3
351 ... 375	87						132.4	87						136.3
376 ... 425	98						143.4	98						147.3
426 ... 475	110						155.4	110						159.3
476 ... 500	111						156.4	111						160.3

1) The dimension corresponds to the E value (piston rod extension) of the drive

Standards-based cylinders DSBG, to ISO 15552

Accessories

Ordering data – Bellows kit

An extended piston rod (order code E) is absolutely required when using a bellows kit → Ordering data – Modular products.

The necessary dimension for order code E as a function of piston diameter and cylinder stroke as well as the corresponding bellows kit is indicated in the table below:

Order example:

Selected standards-based cylinder:

DSBG-32-320-PPV-A- ...

The dimension for the corresponding E value (see table):
112 mm

Complete type code for standards-based cylinder:

DSBG-32-320-PPV-A- ...-112E

The corresponding bellows kit:

DADB-V6-32-S301-350

Cylinder data			Bellows kit		Cylinder data			Bellows kit	
∅	Stroke	Dimen- sion for E	Part No.	Type	∅	Stroke	Dimen- sion for E	Part No.	Type
[mm]	[mm]	[mm]			[mm]	[mm]	[mm]		
32	10 ... 50	29	553271	DADB-V6-32-S10-50	40	10 ... 50	28	553291	DADB-V6-40-S10-50
	51 ... 125	47	553273	DADB-V6-32-S51-125		51 ... 125	43	553293	DADB-V6-40-S51-125
	126 ... 175	61	553275	DADB-V6-32-S126-175		126 ... 175	56	553295	DADB-V6-40-S126-175
	176 ... 250	80	553277	DADB-V6-32-S176-250		176 ... 250	72	553297	DADB-V6-40-S176-250
	251 ... 300	96	553279	DADB-V6-32-S251-300		251 ... 300	86	553399	DADB-V6-40-S251-300
	301 ... 350	112	553281	DADB-V6-32-S301-350		301 ... 350	100	553301	DADB-V6-40-S301-350
	351 ... 375	114	553283	DADB-V6-32-S351-375		351 ... 375	101	553303	DADB-V6-40-S351-375
	376 ... 425	130	553285	DADB-V6-32-S376-425		376 ... 425	115	553305	DADB-V6-40-S376-425
	426 ... 475	145	553287	DADB-V6-32-S426-475		426 ... 475	130	553307	DADB-V6-40-S426-475
	476 ... 500	147	553289	DADB-V6-32-S476-500		476 ... 500	131	553309	DADB-V6-40-S476-500
50	10 ... 50	28	553311	DADB-V6-50-S10-50	63	10 ... 50	28	553331	DADB-V6-63-S10-50
	51 ... 125	46	553313	DADB-V6-50-S51-125		51 ... 125	46	553333	DADB-V6-63-S51-125
	126 ... 175	56	553315	DADB-V6-50-S126-175		126 ... 175	56	553335	DADB-V6-63-S126-175
	176 ... 250	73	553317	DADB-V6-50-S176-250		176 ... 250	73	553337	DADB-V6-63-S176-250
	251 ... 300	86	553319	DADB-V6-50-S251-300		251 ... 300	86	553339	DADB-V6-63-S251-300
	301 ... 350	97	553321	DADB-V6-50-S301-350		301 ... 350	97	553341	DADB-V6-63-S301-350
	351 ... 375	105	553323	DADB-V6-50-S351-375		351 ... 375	105	553343	DADB-V6-63-S351-375
	376 ... 425	116	553325	DADB-V6-50-S376-425		376 ... 425	116	553345	DADB-V6-63-S376-425
	426 ... 475	126	553327	DADB-V6-50-S426-475		426 ... 475	126	553347	DADB-V6-63-S426-475
	476 ... 500	134	553329	DADB-V6-50-S476-500		476 ... 500	134	553349	DADB-V6-63-S476-500
80	10 ... 50	25	553351	DADB-V6-80-S10-50	100	10 ... 50	25	553371	DADB-V6-100-S10-50
	51 ... 125	37	553353	DADB-V6-80-S51-125		51 ... 125	37	553373	DADB-V6-100-S51-125
	126 ... 175	49	553355	DADB-V6-80-S126-175		126 ... 175	49	553375	DADB-V6-100-S126-175
	176 ... 250	62	553357	DADB-V6-80-S176-250		176 ... 250	62	553377	DADB-V6-100-S176-250
	251 ... 300	74	553359	DADB-V6-80-S251-300		251 ... 300	74	553379	DADB-V6-100-S251-300
	301 ... 350	86	553361	DADB-V6-80-S301-350		301 ... 350	86	553381	DADB-V6-100-S301-350
	351 ... 375	87	553363	DADB-V6-80-S351-375		351 ... 375	87	553383	DADB-V6-100-S351-375
	376 ... 425	98	553365	DADB-V6-80-S376-425		376 ... 425	98	553385	DADB-V6-100-S376-425
	426 ... 475	110	553367	DADB-V6-80-S426-475		426 ... 475	110	553387	DADB-V6-100-S426-475
	476 ... 500	111	553369	DADB-V6-80-S476-500		476 ... 500	111	553389	DADB-V6-100-S476-500

Standards-based cylinders DSBG, to ISO 15552

Accessories



Multi-position kit DPNC

Materials:

Flange: Wrought aluminium alloy
Threaded pins, hex nuts: Galvanised steel

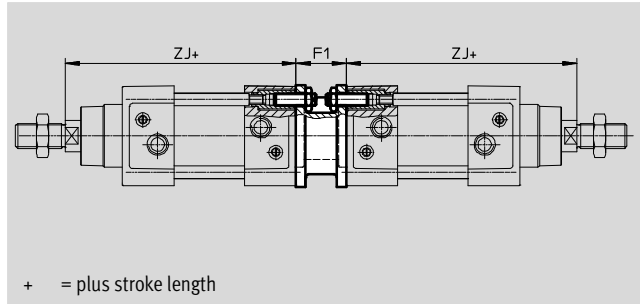
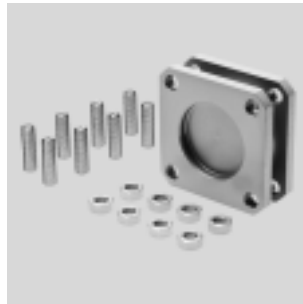

Dimensions and ordering data						
For Ø	F1	ZJ	Max. complete stroke	Weight	Part No.	Type ¹⁾
[mm]		+1.8	[mm]	[g]		
32	27	119.1	500	292	174418	DPNC-32
40	27	133.9	800	410	174419	DPNC-40
50	32	141.8	800	335	174420	DPNC-50
63	28	157.1	700	390	174421	DPNC-63
80	38	173.6	1000	847	174422	DPNC-80
100	38	187.5	900	1200	174423	DPNC-100
125	48	225	1000	2102	174424	DPNC-125

1) Suitable for ATEX

Note
The maximum overall stroke length must not be exceeded when combining cylinders and multi-position kits.

Connecting two cylinders with identical piston Ø as a 3 or 4-position cylinder

A 3 or 4-position cylinder consists of two separate cylinders whose piston rods advance in opposing directions.

This means that depending on actuation and stroke division, this type of cylinder can assume up to four

positions. In each case the cylinder is driven precisely against a stop. Note that when one end of the piston rod is

fixed, the cylinder barrel executes the movement. The line connections to the cylinder must be flexible.

To achieve 3 positions

Two cylinders with identical stroke length must be connected together.

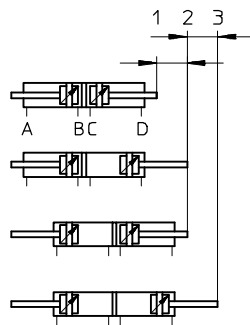

To achieve 4 positions

Two cylinders with different stroke lengths must be connected together.

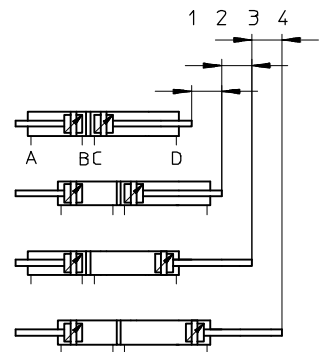

Standards-based cylinders DSBG, to ISO 15552

Accessories

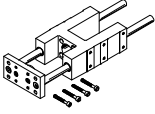
Ordering data – Guide units for fixed strokes (recirculating ball bearing guide only)				Technical data → Internet: festo		
	Stroke [mm]	Part No.	Type ¹⁾	Stroke [mm]	Part No.	Type ¹⁾
	For Ø 32 mm				For Ø 40 mm	
	10 ... 50	34493	FENG-32-50-KF	10 ... 50	34499	FENG-40-50-KF
	10 ... 100	34494	FENG-32-100-KF	10 ... 100	34500	FENG-40-100-KF
	10 ... 160	34495	FENG-32-160-KF	10 ... 160	34501	FENG-40-160-KF
	10 ... 200	34496	FENG-32-200-KF	10 ... 200	34502	FENG-40-200-KF
	10 ... 250	150289	FENG-32-250-KF	10 ... 250	34503	FENG-40-250-KF
	10 ... 320	34497	FENG-32-320-KF	10 ... 320	34504	FENG-40-320-KF
	10 ... 400	150290	FENG-32-400-KF	10 ... 400	150291	FENG-40-400-KF
	10 ... 500	34498	FENG-32-500-KF	10 ... 500	34505	FENG-40-500-KF
For Ø 50 mm				For Ø 63 mm		
	10 ... 50	34506	FENG-50-50-KF	10 ... 50	34513	FENG-63-50-KF
	10 ... 100	34507	FENG-50-100-KF	10 ... 100	34514	FENG-63-100-KF
	10 ... 160	34508	FENG-50-160-KF	10 ... 160	34515	FENG-63-160-KF
	10 ... 200	34509	FENG-50-200-KF	10 ... 200	34516	FENG-63-200-KF
	10 ... 250	34510	FENG-50-250-KF	10 ... 250	34517	FENG-63-250-KF
	10 ... 320	34511	FENG-50-320-KF	10 ... 320	34518	FENG-63-320-KF
	10 ... 400	150292	FENG-50-400-KF	10 ... 400	34519	FENG-63-400-KF
	10 ... 500	34512	FENG-50-500-KF	10 ... 500	34520	FENG-63-500-KF
For Ø 80 mm				For Ø 100 mm		
	10 ... 50	34521	FENG-80-50-KF	10 ... 50	34529	FENG-100-50-KF
	10 ... 100	34522	FENG-80-100-KF	10 ... 100	34530	FENG-100-100-KF
	10 ... 160	34523	FENG-80-160-KF	10 ... 160	34531	FENG-100-160-KF
	10 ... 200	34524	FENG-80-200-KF	10 ... 200	34532	FENG-100-200-KF
	10 ... 250	34525	FENG-80-250-KF	10 ... 250	34533	FENG-100-250-KF
	10 ... 320	34526	FENG-80-320-KF	10 ... 320	34534	FENG-100-320-KF
	10 ... 400	34527	FENG-80-400-KF	10 ... 400	34535	FENG-100-400-KF
	10 ... 500	34528	FENG-80-500-KF	10 ... 500	34536	FENG-100-500-KF

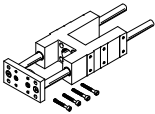
Ordering data – Guide units for variable strokes				Technical data → Internet: festo	
	For Ø [mm]	Stroke [mm]	With recirculating ball bearing guide Part No. Type ¹⁾	With plain-bearing guide Part No. Type ¹⁾	
		32	10 ... 500	34487 FENG-32-...-KF	34481
	40	10 ... 500	34488 FENG-40-...-KF	34482	FENG-40-...-GF
	50	10 ... 500	34489 FENG-50-...-KF	34483	FENG-50-...-GF
	63	10 ... 500	34490 FENG-63-...-KF	34484	FENG-63-...-GF
	80	10 ... 500	34491 FENG-80-...-KF	34485	FENG-80-...-GF
	100	10 ... 500	34492 FENG-100-...-KF	34486	FENG-100-...-GF

1) Suitable for ATEX

Standards-based cylinders DSBG, to ISO 15552

FESTO

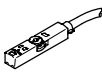
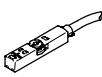

Accessories

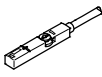
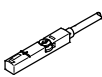
Ordering data – Proximity sensor for T-slot, magneto-resistive						Technical data → Internet: smt	
	Type of mounting	Switching output	Electrical connection	Cable length [m]	Part No.	Type	
N/O contact							
	Inserted in the slot from above, flush with the cylinder profile, short design	PNP	Cable, 3-wire	2.5	574335	SMT-8M-A-PS-24V-E-2,5-OE	
			Plug connector M8x1, 3-pin	0.3	574334	SMT-8M-A-PS-24V-E-0,3-M8D	
			Plug connector M12x1, 3-pin	0.3	574337	SMT-8M-A-PS-24V-E-0,3-M12	
		NPN	Cable, 3-wire	2.5	574338	SMT-8M-A-NS-24V-E-2,5-OE	
			Plug connector M8x1, 3-pin	0.3	574339	SMT-8M-A-NS-24V-E-0,3-M8D	
N/C contact							
	Inserted in the slot from above, flush with the cylinder profile, short design	PNP	Cable, 3-wire	7.5	574340	SMT-8M-A-PO-24V-E-7,5-OE	

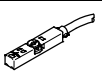
Ordering data – Proximity sensors for T-slot, magnetic reed						Technical data → Internet: sme	
	Type of mounting	Switching output	Electrical connection	Cable length [m]	Part No.	Type	
N/O contact							
	Inserted in the slot from above, flush with the cylinder profile	Contacting	Cable, 3-wire	2.5	543862	SME-8M-DS-24V-K-2,5-OE	
				5.0	543863	SME-8M-DS-24V-K-5,0-OE	
			Cable, 2-wire	2.5	543872	SME-8M-ZS-24V-K-2,5-OE	
			Plug connector M8x1, 3-pin	0.3	543861	SME-8M-DS-24V-K-0,3-M8D	
N/C contact							
	Insertable in the slot from above, flush with the cylinder profile	Contacting	Cable, 3-wire	7.5	546799	SME-8M-DO-24V-K-7,5-OE	



Ordering data – Proximity sensor for T-slot, magneto-resistive, for ATEX zone							Technical data → Internet: smt	
	Type of mounting	ATEX category		Switching output	Electrical connection	Cable length [m]	Part No.	Type
		Gas	Dust					
N/O contact								
	Insertable in the slot from above, flush with the cylinder profile, short design	II 3G	II 3D	PNP	Plug connector M8x1, 3-wire	0.3	574342	SMT-8M-A-PS-24V-E-0,3-M8D-EX2

Ordering data – Safety clip for ATEX zone			
	Description	For size	Part No. Type
	<ul style="list-style-type: none"> Protects "equipment that is not intrinsically safe" against simple disconnection, here the plug connector of the proximity sensor SMT and connecting cable NEBU ATEX category: gas: II 3G / dust: II 3D 	Plug connector M8x1	548067 NEAU-M8-GD

Ordering data – Connecting cables					Technical data → Internet: nebu	
	Electrical connection, left	Electrical connection, right	Cable length [m]	Part No.	Type	
	Straight socket, M8x1, 3-pin	Cable, open end, 3-wire	2.5	541333	NEBU-M8G3-K-2.5-LE3	
			5	541334	NEBU-M8G3-K-5-LE3	
	Straight socket, M12x1, 5-pin	Cable, open end, 3-wire	2.5	541363	NEBU-M12G5-K-2.5-LE3	
			5	541364	NEBU-M12G5-K-5-LE3	
	Angled socket, M8x1, 3-pin	Cable, open end, 3-wire	2.5	541338	NEBU-M8W3-K-2.5-LE3	
			5	541341	NEBU-M8W3-K-5-LE3	
	Angled socket, M12x1, 5-pin	Cable, open end, 3-wire	2.5	541367	NEBU-M12W5-K-2.5-LE3	
			5	541370	NEBU-M12W5-K-5-LE3	

Standards-based cylinders DSBG, to ISO 15552

Accessories



Ordering data – Mounting kits for proximity sensor SME/SMT-8			
	For Ø	Materials	Part No. Type
	32 ... 100	Rail: Anodised wrought aluminium alloy Screws: High-alloy stainless steel Free of copper and PTFE	537806 SMBZ-8-32/100
	125		1451483 DASP-M4-125-A



Ordering data – Mounting kit for proximity sensor SME/SMT-8				Technical data → Internet: smbr	
	For Ø	Mounting	CRC ¹⁾	Part No.	Type
	32 ... 100	On the cylinder barrel via clamping strap	4	538937	SMBR-8-8/100-S6

1) Corrosion resistance class CRC 4 to Festo standard FN 940070
Particularly high corrosion stress. Outdoor exposure under extreme corrosive conditions. Parts exposed to aggressive media, for instance in the chemical or food industries. These applications may need to be supported by special tests (→ also FN 940082) using appropriate media.

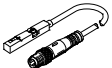
Position sensor

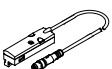
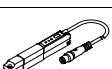
The position sensor continuously senses the position of the piston. It has an analogue output with an output signal in proportion to the piston position.

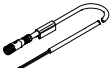
Ordering data – Position sensor for T-slot							Technical data → Internet: position sensor		
	For Ø	Position measuring range	Analogue output		Type of mounting	Electrical connection	Cable length [m]	Part No.	Type
			[V]	[mA]					
	32 ... 125	0 ... 40	0 ... 10	–	Inserted in the slot from above	Plug connector M8x1, 4-pin, in-line	0.3	553744	SMAT-8M-U-E-0,3-M8D
	125	0 ... 50	0 ... 10	4 ... 20	Inserted into the slot lengthwise	Plug M8x1, 4-pin, right angle	–	540191	SMAT-8E-S50-IU-M8
						Plug connector M8x1, 4-pin, in-line	0.3	570134	SMAT-8E-S50-IU-E-0,3-M8D
	32 ... 125	0 ... 50	–	4 ... 20	Inserted in the slot from above	Plug connector M8x1, 4-pin, in-line	0.3	1531265	SDAT-MHS-M50-1L-SA-E-0.3-M8
		0 ... 80						1531266	SDAT-MHS-M80-1L-SA-E-0.3-M8
		0 ... 100						1531267	SDAT-MHS-M100-1L-SA-E-0.3-M8
		0 ... 125						1531268	SDAT-MHS-M125-1L-SA-E-0.3-M8
		0 ... 160						1531269	SDAT-MHS-M160-1L-SA-E-0.3-M8

Ordering data – Connecting cables				Technical data → Internet: nebu	
	Electrical connection, left	Electrical connection, right	Cable length [m]	Part No.	Type
	Straight socket, M8x1, 4-pin	Cable, open end, 4-wire	2.5	541342	NEBU-M8G4-K-2.5-LE4
			5	541343	NEBU-M8G4-K-5-LE4
	Angled socket, M8x1, 4-pin	Cable, open end, 4-wire	2.5	541344	NEBU-M8W4-K-2.5-LE4
			5	541345	NEBU-M8W4-K-5-LE4

Standards-based cylinders DSBG, to ISO 15552

FESTO

Accessories

Ordering data – Rectangular proximity sensors, pneumatic			Technical data → Internet: smpo	
	Mounting	Pneumatic port	Part No.	Type
3/2-way valve, normally closed				
	Via accessories	Barbed connector for tubing I.D. 3 mm	31008	SMPO-1-H-B

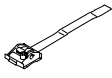
Ordering data – Mounting kit for proximity sensor SMPO-1			Technical data → Internet: smbs	
	For Ø	Mounting	Part No.	Type
	32 ... 100 mm	On the cylinder barrel via clamping strap	151226	SMBS-2